

ISSN 2615-3726 (Online)
ISSN 2621-5667 (Print)

Asian Institute of Research
Journal of Economics and Business
Vol. 3, No.1 March 2020

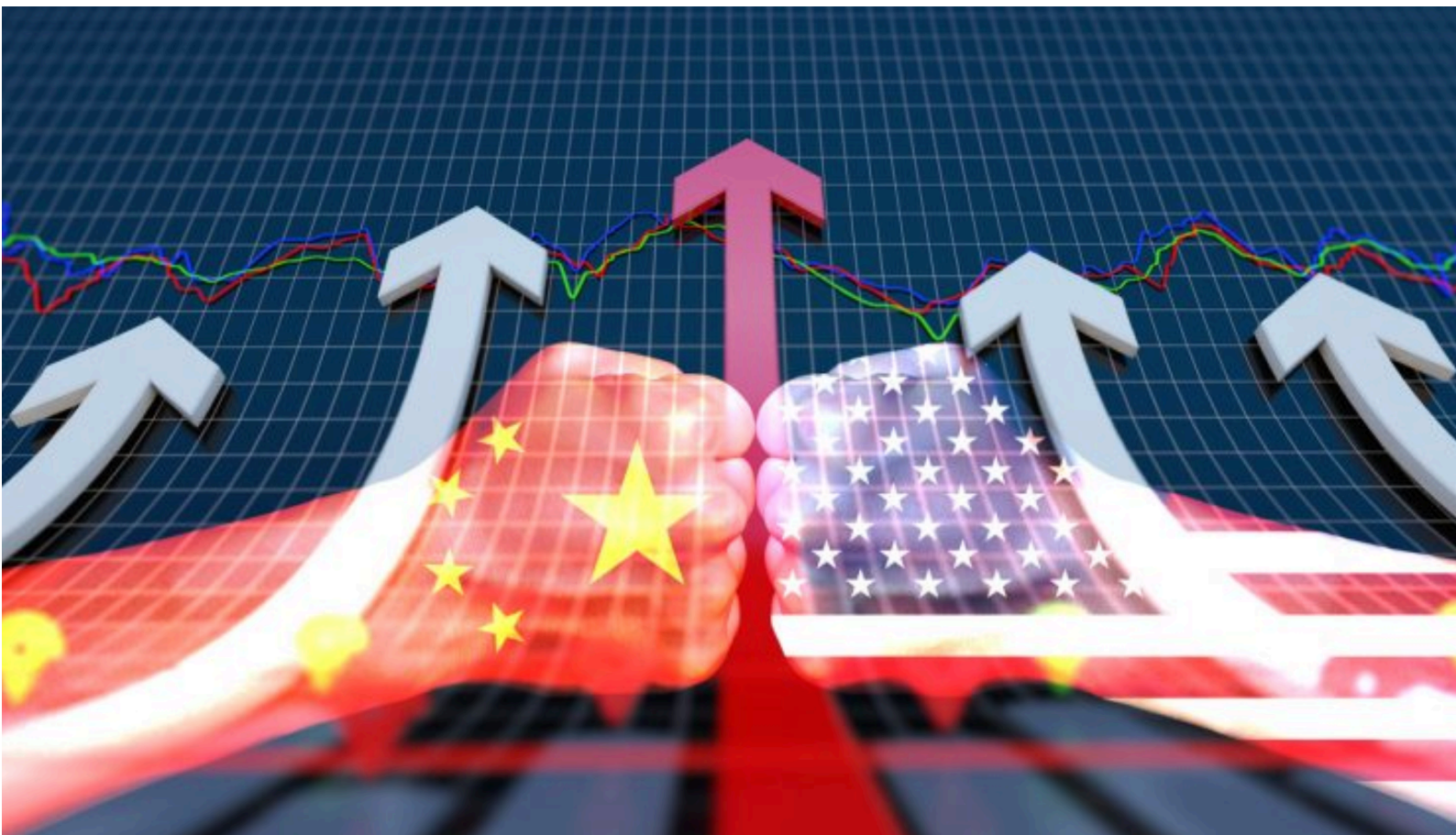

ASIAN INSTITUTE OF RESEARCH
Connecting Scholars Worldwide



Asian Institute of Research
Journal of Economics and Business
Vol.3, No.1 March 2020

Table of Contents	i
Journal of Economics and Business Editorial Board	v
The Cointegration Relationship and Causal Link of Internet Penetration and Broadband Subscription on Economic Growth: Evidence from ASEAN Countries	1
Aileen L. Camba, Abraham C. Camba, Jr.	
Evaluation Study on the Barriers to Success of Technology Business Incubation Programme in Nigeria – The Moderating Role of Government Policy	9
Nkem O. Obaji, Dele Olaolu	
Empirical Testing of the Five-Factor Model of Fama and French in Indonesia as an Emerging Capital Market	19
Mustaruddin Saleh	
Economic Valuation of Military Checkpoint-Induced Travel Time Variability in Abuja, Nigeria (2012-2017)	29
Ibrahim Gerarh Umaru, Abubakar Mohammed Tanko	
Leadership: A Comprehensive Review of Literature, Research and Theoretical Framework	44
Sait Revda Dinibutun	
Determinants of Board Independence in the Banking Sector of Bangladesh	65
Md. Rezaul Karim, Ranjan Kumar Mitra, Ibrahim Khan	
The Effect of Specific Factors on Bank Profitability: Evidence from Nepalese Banks	82
Prem Bahadur Budhathoki, Chandra Kumar Rai	
An Integrated Model for Career Preferences of the Graduates in Bangladesh	90
Taskina Ali	
The Impact of Effective Training on Employee Retention: A Study in Private Banks of Bangladesh	96
Shahin Akther, Javed Tariq	
Analysis of the Effect of Loan to Deposit Ratio, Non-Performing Loans and Capital Adequacy Ratio on Return on Assets with Good Corporate Governance as Intervening Variable in Banking Companies Listed in the Corporate Governance Perception Index (CGPI) for the Period 2014 – 2018	115
Viviana Tantiara Arsew, Zainul kisman, Ni Nyoman Sawitri	

Human Resources Management Practices and Total Quality Management (TQM) is the Precondition to Gain the Sustainable Competitive Advantage in the Bangladesh Ready-Made Garments Sector	131
Farhana Rashid, Che Azlan Taib, Rushami Zien Yusoff, Mohd Akhir Hj. Ahmad	
The Level of Adoption of the International Accounting Standard 34 (IAS 34.) : The Case of Bahrain Listed Companies	142
Abdulla A. Rahman Ali	
Emerging Technologies in Management Accounting	152
Bruce H. Geddes	
The Role of Well-being on the Impact of High Performance Work Systems on Physicians' Job Burnout	160
Thadeus Mkamwa	
Analysis of Capital Adequacy Ratio, Prime Lending Rate, and Third-Party Funds on Profitability of Commercial Banks in Indonesia, With Liquidity as Intervening Variable	172
Purwani Pujiati, Zainul Kisman, Aam Bastaman	
Crime Treasure Islands: Tax Havens, Tax Evasion and Money Laundering	189
Michele Sabatino	
Building Acceleration of Economic Growth Model Through Education and Health Budget Allocation: Cases in Indonesia	200
Hasyim, Rina Anindita, Baharudin, Gunawan	
The Moderating Role of the Legal Environment on the Relationship between TMT Characteristics and Organizational Performance in a Regulatory Setting in Kenya	211
Joseph O. Oketch, James M. Kilika, Godfrey M. Kinyua	
Prioritization of Storm Water Drain Construction for an Urban Area in the Chittagong Hill Tracts Region of Bangladesh	223
Md. Mohirul Islam Mohir, Shaolin Shawon	
Risk Management: Comparative Study between Islamic Banks and Conventional Banks	232
Zainul Kisman	
Analysis of the Effect of Business Strategy and Financial Distress on Tax Avoidance	238
Arja Sadjarto, Sylvia Hartanto, Natalia, Stephani Octaviana	

Cafes: New Learning and Knowledge Production Space for Millennial Students	247
Yohanes Slamet Purwadi, Elvy Maria Manurung	
An Assessment on the Influence of Entrepreneurial Training, Risk-Taking and Innovativeness on SMEs Development in Nigeria	254
Dele Olaolu, Nkem Okpa Obaji	
The Effect of Audit Quality on Financial Performance of Deposit Money Banks (Evidence from Nigeria)	270
Chukwuma C. Ugwu, Lilian N. Aikpitanyi, Sonia Idemudia	
Determinant Return on Assets and Its Impact on Assets Growth (Case Study of Sharia General Banks in Indonesia)	282
M. Noor Salim, Hardian Arief Winanto	
Assessment of Relationship Between Personal Attitude and the Entrepreneurship Intention Among Students in Federal Polytechnic in Northern Nigeria	295
S. I. Attahiru, M. A. Olaoye, B. Isyaku, M. Abubakar	
An Empirical Analysis on Liquidity Management of Commercial Banks in Bangladesh: A Comparative Study Between State-Owned and Private Commercial Banks	299
Raad Mozib Lalon, Nadia Naher	
Firm Characteristics and Stock Returns of Nigerian Quoted Firms: A Two-Sector Comparative Analysis	313
Akinyemi Kayode Peter, Oke Mike Ojo, Olaolu Adegboyega Adewoye	
The Influence of Investment Decisions and Funding Decisions on the Value of Companies with Ownership Structure as Moderated Variables in Manufacturing Companies Listed in Indonesia Stock Exchange (BEI)	328
Aqimissolati, Sulastri, Isnuhardi, Agustina Hanafi	
The Diaspora and the Process of Economic Development in Cameroon	344
Saidou Baba Oumar, Urie Eléazar Jumbo, Salihu Zummo Hayatudeen	
Tax Incentives and Investment Growth: The Nigerian Perspective	363
Chukwuma C. Ugwu, Iyana E. Okwa, Ernest E. Inyang	
The Influence of Demographic Attributes in the Implementation of Accrual-Based International Public Sector Accounting Standards	374
Charles K. Matekele, Gabriel V. Komba	
Does Pecking Order Theory Hold Among Kenyan Firms?	386
Douglas M. Wanja, Peter W. Muriu	

Foreign Direct Investment and Economic Growth Of Nigeria (1980-2018) F. O. Chinyere Osunkwo	398
Community Buyers' Affective Reactions in Social Commerce: Stimuli and Response Ying-CHieh Yang, I-Hua Lin, Hui-Chu Chen	404
The Difference in Competitiveness of Indonesian Biodiesel between Spain and the EU Yoyon Muzayyin, Dwidjono Hadi Darwanto, Masyhuri	419
Impact of Organizational Culture on Employee Satisfaction: A Case of Hilton Hotel, United Kingdom Christine Reidhead	432
Non-Linear Effect of Government Spending on Private Consumption in Cambodia: Markov-Switching Autoregressive Model Leanghak Hok	438
Dynamic Capabilities and Performance: The Mediating Role of Firm Competence Gabriel Kitenga, J. M. Kilika, A. W. Muchemi	450

Journal of Economics and Business Editorial Board

Editor-In-Chief

Prof. Alexandros Psychogios (United Kingdom)

Editorial Board

Prof. Dr. Vica Davidaviciene (Lithuania)

Prof. Cosimo Magazzino (Italy)

Prof. Dr Roselina Binti Ahmad Saufi (Malaysia)

Assistant Prof. Ali Faruk Acikgoz (Turkey)

Assoc. Prof. Kherchi Ishak (Algeria)

Assoc. Prof. Dr. Juan Ignacio Pulido-Fernández (Spain)

Dr. Joaquín Texeira Quirós (Spain)

Dr. Maria Rosario Hernandez Justino (Portugal)

Assistant Prof. Christian Rianero (Italy)

Assistant Prof. Dr. İdil Göksel (Turkey)

Asst. Prof. Dr.Kittipong Sophonthummapharn (Thailand)

Assoc. Prof. Elf Akben Selcuk (Turkey)

Dr. Emmanuel Senyo Fianu (Italy)

Assistant Prof. Seyed Alireza Athari (Cyprus)

Assistant Prof. Abderrazak Hassan Elkhadi (Tunisia)

Assistant Prof. Ikechukwu Nwaka (Turkey)

Muhammad Ishtiaq Ishaq, Ph.D. (Italy)

Maria-Dolores Guillamon, Ph.D. (Spain)

Prof. George Abuselidze (Georgia)

Assoc. Prof. Mohammed Fellague (Algeria)

Assoc. Prof. Haitham Nobanee (United Arab Emirates)

Dr. Vasiliki Brinia (Greece)

Teguh Sugiarto (Indonesia)

Assistant Prof. Dr. Ahsan Riaz (Pakistan)

Dr. Samar Rahi (Malaysia)

Prof. Ravi Kumar Bommiseti (India)



The Cointegration Relationship and Causal Link of Internet Penetration and Broadband Subscription on Economic Growth: Evidence from ASEAN Countries

Aileen L. Camba¹, Abraham C. Camba, Jr.¹

¹ Department of Economics, College of Social Sciences and Development, Polytechnic University of the Philippines, Sta. Mesa, Manila, Philippines

Correspondence: Abraham C. Camba, Jr., 512 Unit Villa Alicia III, P. Tuazon Avenue, Bgry. Kaunlaran, Quezon City, Metro Manila, Philippines, 1111. Tel: (632)9175408300. E-mail: accamba@pup.edu.ph

Abstract

This study explores the cointegration relationship and causal link of internet penetration and broadband subscription to economic growth from the 10 countries of ASEAN for the period 2000-2016. A pooled multiple regression model with GDP growth as a function of internet penetration and broadband subscription was developed. The Johansen-Fisher panel cointegration was applied to determine the presence of a long-run equilibrium relationship among the three variables and the direction of causality was identified by estimating the panel-based vector error correction model (VECM). Results from cointegration test indicate a long run equilibrium relationship between internet penetration, broadband subscription and economic growth. The causality test reveals there is long run causality running from internet penetration and broadband subscription to economic growth. In the short-run, broadband subscription causes economic growth in the ASEAN countries. However, internet penetration has no causal link with economic growth in the short-run during the period 2000-2016. The findings are supportive of the claim that internet penetration and broadband connections are engine of economic growth and are rapidly transforming ASEAN economies. Based on these findings, this study recommends that ASEAN governments should be supportive on policies that promotes better internet and broadband infrastructure to achieved short and long-run economic growth.

Keywords: ASEAN, Broadband Subscription, Causality, Economic Growth, Internet Penetration, Panel Cointegration

1. Introduction

Modern theories of endogenous growth acknowledge that adoption of new technologies (i.e., digital technologies) enhance the innovative capacities of the economy through knowledge spillover, development of new products and processes, and business models to promote growth. Thus, the dramatic expansion of digital technologies has facilitated searching, matching, and sharing of information and contributed to greater organization and collaboration among economic agents—influencing how firms operate, people seek opportunities, and citizens

interact with their governments (Benhabib & Spiegel, 2005; World Bank, 2016; Kelly, Liaplina, Tan, & Winkler, 2017).

In particular, internet penetration and broadband subscription have vast potential for inclusive growth and socio-economic development because they increase productivity and contribute to the overall economic growth by connecting remote areas to markets, promoting access to social services, expanding educational opportunities, establishing platforms for innovation and enabling people's access to government services (Choi & Yi, 2009; Elgin, 2013; Zhang, 2013). During the 2000-2016 period, ASEAN countries have adopted policies that have led to the massive growth of the use of the internet in their countries. Governments of ASEAN have recognized the significant growth potential of the internet along with other ICT infrastructure (i.e., broadband) to their economies. Given the diversity of economic growth around ASEAN, perhaps it is not surprising that internet penetration and broadband subscription isn't evenly distributed across the region (see Figure 1).

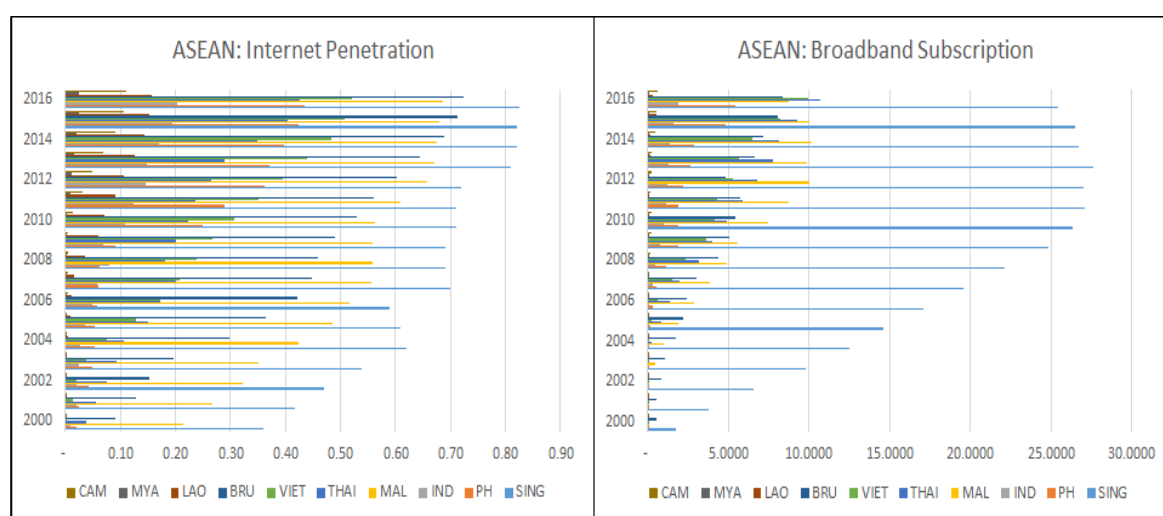

Figure 1. Digital Divide within ASEAN

ASEAN has to work harder to erase the digital divide and raise its game across the board to enhance intra-regional connectivity. The risk of a widening digital divide within ASEAN can undermine plans to turn the digital economy into an engine of growth. Thus, this study explores the cointegration relationship and causal link of internet penetration and broadband subscription to economic growth from the 10 countries of ASEAN for the period 2000-2016.

2. Method

This study used dataset of 10 ASEAN member countries for the period 2000 to 2016. The core variables used in the study were real GDP growth rate (%), internet penetration (% of population) and fixed broadband subscription (per 100 people). Data for these variables were obtained from the World Development Indicators (WDI) by the World Bank.

2.1. Panel Pooled Multiple Regression Model

A pooled multiple regression model with GDP growth (GDPGRW) as a function of internet penetration (IPEN) and fixed broadband subscription (BROAD) was developed. Thus, the economic growth equation in functional form is:

$$\text{GDPGRW} = f(\text{IPEN}, \text{BROAD}) \quad (1)$$

where:

GDPGRW = real GDP growth rate (%)

IPEN = internet penetration (% of population)

BROAD = fixed broadband subscription (per 100 people)

Intuitively, the above functional model means that economic growth is driven by internet penetration (IPEN) and broadband subscription (BROAD). Internet penetration and broadband subscription allows the generation and distribution of decentralized information and ideas in markets increasingly relying in information as an input. In light of this, economic growth is accelerated by facilitating the development and adoption of innovation processes. Internet and broadband subscription may accelerate the distribution of ideas and information and foster competition for and development of new products, processes, and business models, thereby further promoting long-run economic growth. In its stochastic form, it can be mathematically expressed as follows:

$$GDPGRW_{it} = \alpha_0 + \alpha_1 IPEN_{it} + \alpha_2 BROAD_{it} + \varepsilon_{it} \quad (2)$$

where:

α_0 , α_1 , and α_2 = parameter estimates

ε_{it} = error term

The subscripts i and t represent ASEAN country ($i = 1...10$) and time period (2000-2016), respectively. The standard procedures required us to conduct panel unit root test, panel cointegration test, panel vector error correction model and Wald test.

2.2. Unit Root Test

This study uses the more reliable and well-behaved panel unit root tests such as those developed by Levin, Lin & Chu (2002) and Im, Pesaran & Shin (2003). An alternative approach to panel unit root tests applied in this study are the ADF (augmented Dickey-Fuller)-Fisher and ADF-PP (Phillips-Perron) to ensure comparison and validation of results with a view to further create consistency (Demetriades & Fielding, 2012).

2.3. Johansen-Fisher Panel Cointegration

Where the unit root test gives variables that are of order one integration I(1), then cointegration analysis was applied to determine the presence of a long-run equilibrium relationship among the three variables (real GDP growth rate, internet penetration and fixed broadband subscription). Madalla and Wu (1999) relied on the Johansen (1988) test for cointegration to consider the suggestion of Fisher (1932) to combine trace test and max-eigen statistics to test for cointegration in full panel by combining individual cross-sections for cointegration. Johansen-Fisher cointegration test type aggregates p-values of individual Johansen maximum likelihood cointegration test statistics. Unlike Pedroni (2004) and Kao (1999) whose cointegration tests are residual based, the Johansen-Fisher cointegration test is system based cointegration for the whole panel (Madalla & Kim, 1998).

2.4. Panel Causality

The direction of causality was identified by estimating the panel-based vector error correction model (VECM) and used to conduct the causality of internet penetration and fixed broadband subscription on real GDP growth rate. The empirical model is represented by the following equations:

$$\Delta GDPGRW_{it} = \lambda_{1j} + \sum_{k=1}^m \varphi_{11ik} \Delta GDPGRW_{it-k} + \sum_{k=1}^m \varphi_{12ik} \Delta IPEN_{it-k} + \sum_{k=1}^m \varphi_{13ik} \Delta BROAD_{it-k} + \psi_{1i} \varepsilon_{it-1} + \mu_{1it} \quad (3)$$

$$\Delta IPEN_{it} = \lambda_{2j} + \sum_{k=1}^m \varphi_{21ik} \Delta IPEN_{it-k} + \sum_{k=1}^m \varphi_{22ik} \Delta GDPGRW_{it-k} + \sum_{k=1}^m \varphi_{23ik} \Delta BROAD_{it-k} + \psi_{2i} \varepsilon_{it-1} + \mu_{2it} \quad (4)$$

$$\Delta BROAD_{it} = \lambda_{3j} + \sum_{k=1}^m \varphi_{31ik} \Delta BROAD_{it-k} + \sum_{k=1}^m \varphi_{32ik} \Delta GDPGRW_{it-k} + \sum_{k=1}^m \varphi_{33ik} \Delta BROAD_{it-k} + \psi_{3i} \varepsilon_{it-1} + \mu_{3it} \quad (5)$$

where Δ = denotes first differences and k = the optimal lag length. Equations 3 to 5 allows to test the short-run and long-run causality which is determined by investigating the significance using the probability value on the coefficient, ψ , of the error correction term, ε_{it-1} , in the equations.

3. Results and Discussion

3.1 Pooled Multiple Regression Model

The results of the regression in Table 1 shows that internet penetration (IPEN) has a significant and negative effect on GDP growth (GDPGRW) as indicated by the coefficient value of -9.1690 and t-statistic = 3.5327 in absolute term with probability = 0.0005. This means that a 1 percentage point increase in internet penetration lowers economic growth by 9.1690 percentage points. This negative effect can be attributed to the presence of a digital divide in ASEAN countries due to high income inequality (Noh and Yoo, 2008). The rapid expansion of internet usage has resulted in the creation of social inequality- popularly known as digital divide - a phenomenon that have the potential to weaken growth and productivity (Doong & Ho, 2012; Bowles, 2012; Shahiduzzaman & Alam, 2013).

Table 1. Pooled Least Squares Regression Results

Variable	Coefficient	Std. Error	t-statistics	Prob.
C	7.2943	0.5828	12.5148	0.0000
IPEN	-9.1690	2.5955	-3.5327	0.0005
BROAD	0.1683	0.0983	1.7127	0.0888
AR(1)	0.4768	0.0686	6.9461	0.0000
R-squared = 0.4182		F-statistic = 37.3737		DW = 2.1428
Adjusted R-squared = 0.4069		Prob. (F-statistic) = 0.0000		

As for broadband subscription, its positively and statistically influence GDPGRW at 10 percent level of significance. A 1-unit increase in the number of broadband subscription prompted an increase in economic growth by 0.1683 percentage points. The widespread adoption of broadband (i.e. a form of high speed internet) has been linked with economic growth and social wellbeing (Dwivedi, Alsudairi, & Irani, 2009; Holt & Jamison, 2009). The availability of high speed broadband for business and households is a well understood and significant factor to encourage rapid economic growth (Bowles & Wilson, 2010).

The computed adjusted coefficient of determination (Adj. R-squared = 0.4069) shows that 40.69 percent of the total variation in the dependent variable are accounted for by the variation in the explanatory variables while 59.31 percent of the total variation in the GDPGRW is attributable to the influence of other factors not included in the regression equation. The F-statistic = 37.3737 is significant at 1 percent level. This implies that internet penetration and broadband subscription collectively influenced economic growth overtime. These findings are supportive of the claim that internet penetration and broadband connections are an engine of economic growth and rapidly transforming ASEAN economies. The computed DW statistic = 2.1428 indicates the absence of both positive and negative autocorrelations.

Figure 2 exemplifies the effect of internet penetration and broadband subscription on GDP growth of the 10 ASEAN countries. Based on the figure, the 17-year pooled least squares regression model appear to fit the actual behavior of the data. Moreover, the residuals of the series are stationary since the fluctuations are more or less on zero, indicating constancy of error variances.

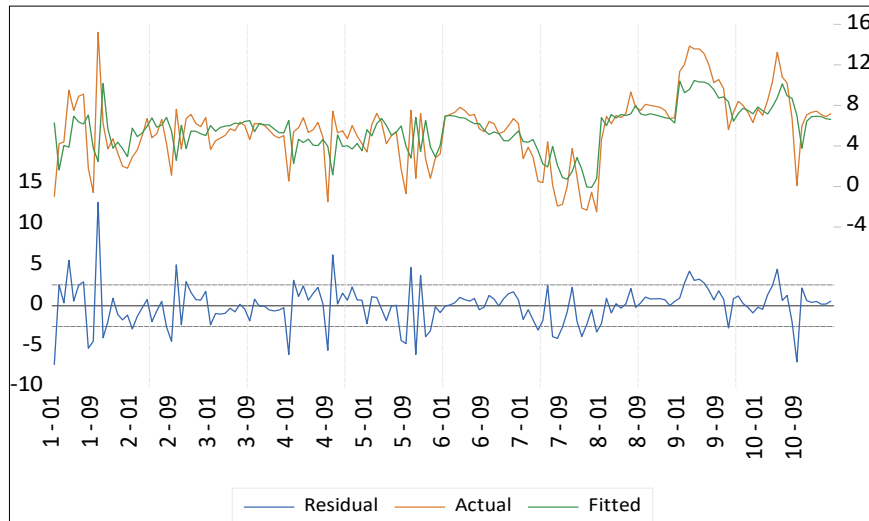

Figure 2. Plot of the Actual, Fitted and Residual for Pooled Regression

3.2 Unit Root Test

We first tested if the relevant variables were stationary as well as determining their order of integration. By looking at Figure 3 one can guess the stationarity or nonstationarity of a series. The nonstationary series GDPGRW, IPEN and BROAD were compared to their stationary series D(GDPGRW), D(IPEN) and D(BROAD). The graph of the series GDPGRW, IPEN and BROAD exhibits a trend suggesting nonstationarity. On the other hand, the graphs of D(GDPGRW), D(IPEN) and D(BROAD) shows pattern with no discernible upward nor downward trend, suggesting stationarity.

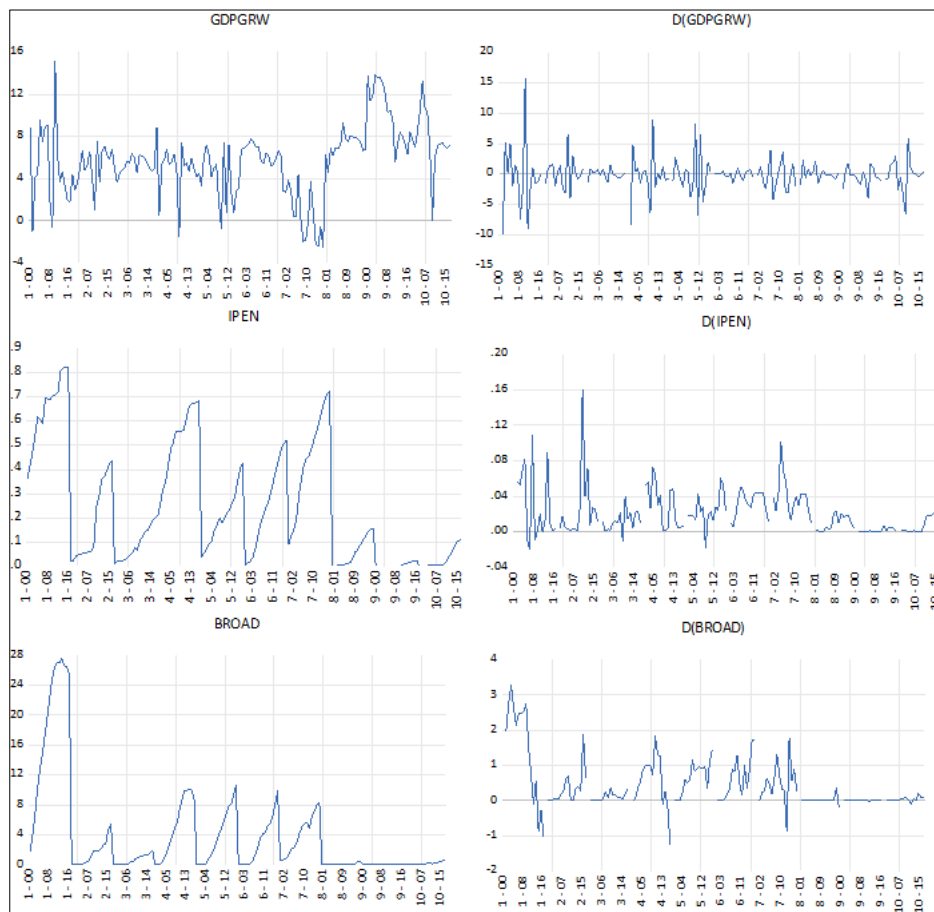

Figure 3. Nonstationary and Stationary Series Plot

The summary of the panel unit test results is presented in Table 2. The results are significant for GDPGRW at levels I(0) signifying the absence of unit root. In the case of IPEN and BROAD are non-stationary at I(0) and must be tested at first difference I(1). All the tests, show that the relevant variables are stationary in first differences, mostly at the 1% level of significance. That is, at I(1) all variables (i.e., D(GDPRW), D(IPEN) and D(BROAD)) are stationary for all the approaches employed signifying absence of unit root at order 1 and meeting the conditions for testing for long-run cointegration tests.

Table 2. Panel Unit Root Results

	Levin, Lin & Chu		Im, Pesaran & Shin		ADF-Fisher		PP-Fisher	
	Stat.	Prob.	Stat.	Prob.	Stat.	Prob.	Stat.	Prob.
At Levels I(0)								
GDPGRW	-5.93	0.00	-4.56	0.00	58.58	0.00	58.81	0.00
IPEN	-0.76	0.99	3.09	0.99	17.47	0.62	18.40	0.56
BROAD	4.03	1.00	7.90	1.00	8.59	0.98	7.52	0.99
At First Difference I(1)								
D(GDPGRW)	-15.09	0.00	-12.18	0.00	138.86	0.00	162.88	0.00
D(IPEN)	-5.12	0.00	-4.56	0.00	56.21	0.00	47.54	0.00
D(BROAD)	-3.16	0.00	-3.27	0.00	51.37	0.00	40.78	0.00

Note: the tests for panel unit roots were specified with individual effects only.

3.3 Johansen-Fisher Panel Cointegration

Table 3 below presents Johansen-Fisher panel cointegration test for potential cointegrating relationships among the variables in level form and first difference. As can be readily seen, both the trace and max-eigen tests suggests that there is a strong cointegrating relationship among these variables. Thus, at least 2 cointegrated relationships can be detected. The null hypothesis of no cointegration is rejected at the 1 percent and 5 percent levels of significance. The findings indicate that there is a cointegration relationship between economic growth and each of the independent variables, internet penetration and broadband subscription, in ASEAN countries. When a cointegration relationship is present, it means that economic growth (GDPGRW), internet penetration (IPEN) and broadband subscription (BROAD) share a common trend and long run equilibrium relationship.

Table 3. Johansen-Fisher Panel Cointegration Results

Hypothesized No. of CE(s)	Trace Test		Max-Eigen Test	
	Stat.	Prob.	Stat.	Prob.
At Levels I(0)				
None	107.80	0.00	80.16	0.00
At most 1	52.95	0.00	39.65	0.00
At most 2	44.66	0.00	44.66	0.00
At First Difference I(1)				
None	104.20	0.00	85.18	0.00
At most 1	43.64	0.00	38.47	0.01
At most 2	31.46	0.05	31.46	0.05

3.4 Panel Causality

From Table 4, the coefficient of ECM (1) is negative 0.219000 and its t-statistic is 3.848640 in absolute term with p-value = 0.0001 which is significant 0.01 level of significance. A negative and significant coefficient of the ECM indicates that any short term fluctuations between the independent variables (i.e., IPEN, BROAD) and the dependent variable GDPGRW will give rise to a stable long-run relationship between the variables. Moreover, we can also say that when C(1) is negative and significant this implies long-run causality running from internet penetration and broadband subscription to economic growth. The speed of adjustment is 0.2190, means that the

whole system is going back to long run equilibrium at the speed 21.90 percent annually. This implies that there has been some disequilibrium in previous years that is now been corrected at the speed of adjustment stated.

Table 4. Vector Error Correction Estimates

	Coefficient	Std. Error	t-statistic	Prob.
C(1)	-0.219000	0.056903	-3.848640	0.0001
C(2)	-0.373024	0.084560	-4.411376	0.000
C(3)	-0.250394	0.075331	-3.323941	0.0010
C(4)	-10.42205	8.874030	-1.174443	0.2409
C(5)	-4.917418	8.706510	-0.564798	0.5725
C(6)	0.083445	0.458752	0.181895	0.8558
C(7)	1.071901	0.490627	2.184760	0.0295
C(8)	-0.306351	0.303335	-1.009942	0.3131
Determinant residual covariance		0.000500		
Equation: $D(\text{GDPGRW}) = C(1)*(\text{GDPGRW}(-1)) + 6.57120030813*\text{IPEN}(-1) + 0.395384523504*\text{BROAD}(-1) - 9.07691329997) + C(2)*D(\text{GDPGRW}(-1)) + C(3)*D(\text{GDPGRW}(-2)) + C(4)*D(\text{IPEN}(-1)) + C(5)*D(\text{IPEN}(-2)) + C(6)*D(\text{BROAD}(-1)) + C(7)*D(\text{BROAD}(-2)) + C(8)$				

3.5 Wald Short-run Causality

Table 5 reports the Wald short run causality results. It shows that broadband subscription causes economic growth in the ASEAN countries. That is, there is short-run causality running from BROAD to GDPGRW. However, internet penetration has no causal link with economic growth in the short-run.

Table 5. Wald Short-run Causality

	Chi-square		
	Value	df	Prob.
IPEN → GDPGRW	2.4464	2	0.2943
BROAD → GDPGRW	11.1492	2	0.0038

4. Conclusion

This paper explored the cointegration relationship and causal link of internet penetration and broadband subscription to economic growth from the 10 countries of ASEAN for the period 2000-2016. A pooled multiple regression model with GDP growth as a function of internet penetration and broadband subscription was developed. The Johansen-Fisher panel cointegration was applied to determine the presence of a long-run equilibrium relationship among the three variables and the direction of causality was identified by estimating the panel-based vector error correction model (VECM). Internet penetration and broadband subscription collectively influenced the economic growth of the ASEAN countries during the period 2000-2016. The findings indicate that there is a long-run equilibrium relationship between economic growth and each of the independent variables, internet penetration and broadband subscription, in ASEAN countries. Moreover, we can also say that there is long run causality running from internet penetration and broadband subscription to economic growth. In the short-run, broadband subscription causes economic growth in the ASEAN countries. However, internet penetration has no causal link with economic growth in the short-run during the period 2000-2016. Based on these findings, this study recommends that ASEAN governments should be supportive on policies that promotes better Internet and broadband infrastructure to further boost economic growth. Likewise, ASEAN governments need to work closely with industry leaders to find ways to proactively promote the growth of internet interconnectivity of the region.

References

- Benhabib, J. & Spiegel, M. (2005). Human Capital and Technology Diffusion. In: Handbook of Economic Growth, Volume 1A, P. Aghion and S.N. Durlauf (eds.), 935-966. Amsterdam: Elsevier. <https://EconPapers.repec.org/RePEc:eee:grochp:1-13>
- Bowles, M. (2012). Digital Economy and Regional Futures: ICT Future Foresight. Innovation and Business Skills Australia: Melbourne.
- Bowles, M. & Wilson P. (2010). The Impact of the Digital Economy and the NBN on skills. Innovation and Business Skills Australia: Melbourne.
- Choi, C. & Yi, M.H. (2009). The effect of the Internet on economic growth: Evidence from cross-country panel data. *Economics Letters*, 105(1), 39-41. <https://doi.org/10.1016/j.econlet.2009.03.028>
- Demetriades, P. & Fielding, D. (2012). Information, institutions, and banking sector development in West Africa. *Economic Inquiry*, 50(3), 739-753. <https://dx.doi.org/10.1111/j.1465-7295.2011.00376.x>.
- Doong, S. & Ho, S. (2012). The impact of ICT development on the global digital divide. *Electronic Commerce Research Applications*, 11(5), 518-533. <http://doi:10.1016/j.elerap.2012.02.002>
- Dwivedi, Y.K., Alsudairi, M.A., & Irani, Z. (2010). Explaining factors influencing the consumer adoption of broadband. *International Journal of Business Information Systems*, 5(4), 393-417. <https://ideas.repec.org/a/ids/ijbisy/v5y2010i4p393-417.html>
- Elgin, C. (2013). Internet Usage and the shadow economy: Evidence from panel data. *Economic Systems*, 37(1), 111-121. <http://doi:10.1016/j.ecosys.2012.08.005>
- Holt, L. & Jamison, M. (2009). Broadband and contributions to economic growth: Lessons from the US experience. *Telecommunications Policy*, 33, 575-581. <http://www.sciencedirect.com/science/article/pii/S0308596109000962>
- Im, K.S., Pesaran, M.H. & Shin, Y. (2003). Testing for unit roots in heterogeneous panels. *Journal of econometrics*, 115(1), 53-74. [http://www.sciencedirect.com/science/article/pii/S03044076\(03\)00092-7](http://www.sciencedirect.com/science/article/pii/S03044076(03)00092-7)
- Johansen, S. (1988). Statistical analysis of cointegration vectors. *Journal of economic dynamics and control*, 12(2-3), 231-254. [http://www.sciencedirect.com/science/article/pii/0165-1889\(88\)90041-3](http://www.sciencedirect.com/science/article/pii/0165-1889(88)90041-3)
- Kao, C. (1999). Spurious regression and residual-based tests for cointegration in panel data. *Journal of econometrics*, 90(1), 1-44. [https://doi.org/10.1016/S0304-4076\(98\)00023-2](https://doi.org/10.1016/S0304-4076(98)00023-2)
- Kelly, T., Liaplina, A., Tan, S., & Winkler, H. (2017). *Reaping Digital Dividends: Leveraging the Internet for Development in Europe and Central Asia*. <https://doi.org/10.1596/978-1-4648-1025-1>
- Levin, A., Lin, C-F., & Chu, C-S. (2002). Unit root tests in panel data: asymptotic and finite-sample properties. *Journal of econometrics*, 108(1), 1-24. <https://ideas.repec.org/a/eee/econom/v108y2002i1p1-24.html>
- Maddala, G.S. & Kim, I.-M. (1998). Unit roots, cointegration, and structural change. Cambridge: Cambridge University Press.
- Maddala, G.S. & Wu, S. (1999). A comparative study of unit root tests with panel data and a new simple test. *Oxford Bulletin of Economics and statistics*, 61(S1), 631-652. <http://dx.doi.org/10.1111/1468-0084.61.s1.13>
- Noh, Y. H. & Yoo, K. (2008). Internet, inequality and growth. *Journal of Policy Modeling*, 30(6), 1005-1016. [http://www.sciencedirect.com/science/article/pii/S0161-8938\(07\)00094-4](http://www.sciencedirect.com/science/article/pii/S0161-8938(07)00094-4)
- Pedroni, P. (2004). Panel cointegration: asymptotic and finite sample properties of pooled time series tests with an application to the PPP hypothesis. *Econometric theory*, 20(3), 597-625. <https://web.williams.edu/Economics/wp/pedronipanelcointegration.pdf>
- Shahiduzzaman, Md. & Alam, K. (2013). Information technology and its changing roles to economic growth and productivity in Australia. *Telecommunications Policy*, 38(2), 125-135. <http://dx.doi.org/10.1016/j.telpol.2013.07.003>
- World Bank (2016). *World Development Report 2016: Digital Dividends*. <https://openknowledge.worldbank.org/bitstream/handle/10986/23347/9781464806711.pdf>
- Zhang, T. (2013). Income disparity and digital divide: The Internet Consumption Model and cross-country empirical research. *Telecommunications Policy*, 37(6), 515-529. <http://doi:10.1016/j.telpol.2012.12.011>



Evaluation Study on the Barriers to Success of Technology Business Incubation Programme in Nigeria – The Moderating Role of Government Policy

Nkem O. Obaji¹, Dele Olaolu²

¹Faculty of Management Sciences, National Open University of Nigeria, Abuja, Nigeria

²Faculty of Management and Social Sciences, Baze University, Abuja, Nigeria

Correspondence: Nkem Obaji, Faculty of Management Sciences, National Open University of Nigeria, Abuja, Nigeria, Tel: +2348169119771 -. E-mail: amazonsng@yahoo.com

Abstract

The business incubation model has been embraced by numerous countries of the world since the concept was first conceived and developed in the USA. It has now received much attention among policymakers and academics particularly within the field of entrepreneurship and small business research. Even though the popularity of the programme, so many tenant firms are still closing shops before and after their exit from the incubator. The aim of this study was to explore how government policy moderates the relationship between the individual critical success factors (CSF) and incubator performance. The study adopted the evaluative qualitative case study design. The population of the study consisted of ten surveying stakeholders who were purposively chosen between the stakeholders. The study found the evidence of the moderating role of government policy on the relationship between barriers to success and incubator performance. The study recommended that government should develop a user friendly framework that will ease the difficulties incubators usually encounter in the course of providing resources to the incubatees.

Keywords: Technology Business Incubation, Government Policy, Nigeria

1. Introduction

In the entrepreneurship space, the part played by small businesses has been highlighted in several entrepreneurship studies (e.g., Higgs & Hill 2019; Agwu & Emeti 2013; Alese 2017). In line with this, small and medium enterprises (SMEs) form the driving force of industrial growth and development in the country. The prominence of SMEs in any country is such that it cannot be ignored by the government of that country, particularly in Nigeria. As a result, it has been established that the growth of SMEs presents as one of the bases of economic development in the country. The positive part of SMEs have been discussed in several SMEs studies, however, the challenges confronting SMEs are numerous. Some of the challenges include funding, business support, infrastructure, and government policy.

Business incubation initiative comes in handy to ameliorate the hitches threatening the small businesses. Entrepreneurial speaking, business incubation assists in the establishment of early-stage enterprises as a strategy to also promote systems of economic development (Al-Mubarak, Al-Karaghoul, & Busler, 2010). Business Incubation is defined by the NBIA as "a business support process that accelerates the successful development of start-up and fledgling companies by providing entrepreneurs with an array of targeted resources and services. These services are usually developed or orchestrated by incubator management and offered both in the business incubator and through its network of contacts". The primary aim of business incubator is to assist new businesses succeed and thereby generate wealth and employment opportunities (NBIA; Pena, 2002).

1.1 Problem Statement

The popularity of business incubation initiative is on the increase now especially as most nations globally have seen it as an instrument for economic development. Despite, the rising interest, misperception about the exact attributes of incubator performance still exists. That is, whether business incubators are indeed attaining their purposes and the precise impact it has on enterprises living in incubator facilities. Despite the popularity of the programme, so many tenant firms are still closing shops before and after their exit from the incubator. Therefore, the intention of this study is to qualitatively evaluate and explore how government policy moderates the relationship between the individual critical success factors and incubator performance.

1.2 Objective of the Study

To explore how government policy moderates the relationship between the individual critical success factors (CSF) and incubator performance

2. Literature Review

The business incubation programme is intended to foster nascent enterprises within one to three years in some sort of secluded place. While in this moderated setting, all the much needed sustenance (e.g., training and mentoring) that are needed for the fledgling enterprises to stay alive are given to them so as to make them to thrive. Theodorakopoulos, Kakabadse, and McGowan (2014) remarked that the tangible components of business incubators' assets had been employed to measure performance, conversely, over time, the focus has been geared towards intangible elements and social aspects of business incubation. Similarly, resources can be tangible as well as intangible (Pergelova & Angulo-Ruiz 2014). The strategic emphasis is positioned on the intangible skills and resources of the firm as they are considered to be non-tradable, more difficult to imitate and take time to build internally (Amit & Schoemaker, 1993). The argument for intangible resources such as business support as part of the CSFs may perhaps be that business incubator being service programmes rather than buildings can assist in growing firms, offer mentoring as well as handholding and support to a fledgling business in meeting its objectives; rather than the idea of approaching the business incubator because of physical building.

Secondly, Financial Resources is the next in line for this study. Entrepreneurially speaking, the part played by financial resources cannot be overemphasised. Levitsky (1996) stated that inadequate access to finance or loan had been one of the most prevalent impediments faced by SMEs in both advanced and evolving countries. In view of this, Abdullahi, Tahir, Aliyu, and Abubakar (2015) noted that inadequate funding indicates the key challenges which can considerably exhibit a direct influence on the capability of a business to grow, upgrade its technology, expand its market, promote its management skills, increase productivity. In the Nigerian context, Olutunla (2005) opined that poor financial resources had been found as the principal inhibitors to SMEs development in Nigeria. In the context of business incubation attainment, several authors have mentioned the role of finance in business incubator performance (Pergelova & Angulo-Ruiz, 2014; Somsuk & Laosirihongthong, 2014).

Furthermore, infrastructure is another factor that authors seem to pick as one of the elements related to the incubation process that spur entrepreneurs to come to the business incubator. It perhaps may be one of the key reasons for a number of entrepreneurs to relocate to the incubator. In entrepreneurship development generally, inadequate infrastructural facilities have posed a challenging difficulty to SMEs processes (Ojo, 2006). Abdullahi et al. (2015) mention the hindrance to infrastructure to include inadequate transportation systems, water supply shortage, poor telecommunication systems, and lack of electricity and solid waste management. Similarly,

Osamwonyi and Tafamel (2010) noted that the obstacles to the SMEs performance in Nigeria businesses have made business owners look for an alternative source of infrastructure; which increases the cost of running the fledgling business. In the business incubation study, Chan and Lau (2005) indicated that infrastructure is in essence a very significant element to the firms residing in the incubator. Kumar and Ravindran (2012) also score a high point to infrastructure as an element of effective incubation programme.

Finally, the distinctiveness of government role in virtually all aspects of a national economy is consequent on the fact that government is always a pacesetter in any national activities. Government policy is a well-established element that wields a substantial sway on a range of activities. (e.g. Ashford, 1993; Asiedu, 2006; Guan, Xie, & Zhou, 2015; Ha & Kang, 2015; Yang, 2014). However, Ojo (2006) noted that Government policies and programmes regarding SMEs had been recognised to be inappropriate, inadequate or inconsistent, and this has since prevented the SMEs growth and development. Furthermore, (Onugu, 2005) also expressed that the SMEs sector in Nigeria has not generally been flourishing for the reason of poor execution of some government policies and policy inconsistencies.

In developing countries, evidence abounds that business incubation programme funding basically depends on government (Akcomak, 2009). Therefore, the effect of government policies still overrules its inconsistencies as well as lack of implementation for the reason that, it still sponsor and fund the scheme. On the contrary, a study has shown that government policy inconsistency does not have significant influence on the performance of small and medium manufacturing firms (Bagshaw, 2014). However, there is considerable evidence in incubator performance literature that opine that lack of government policy makes business incubation practice to be ineffective. The reason being that without government effort through policies, the other resources may not be in place.

In sum, CSF associated with government policy may impact on incubator performance in the course of gaining competitive advantage. Business incubation has helped in no small measure in fostering fledgling businesses through the offering of resources. In this study, an evaluation will be made of the role of government policy in the performance of an incubator initiative programme in Nigeria. This will be done in relation to a related inquiry into the critical success factors of the incubation programme in the particular Nigerian context.

3. Research Methods

3.1 Case Study

Case study research has become more popular in scholarly works related to management. Dul and Hak (2008) defined a case study as "a study in which one case (single case study) or a small number of cases (comparative case study) are selected in their real-world context, and scores obtained from these cases are analysed in a qualitative manner." It is a technique prevalently applied in clinical research where every patient represents a unique case study. Its key goal is to collect all-encompassing, organised, and in-depth information about each case of interest (Patton, 2002). Case studies combine data collection methods such as archives, interviews, questionnaire and observation (Eisenhardt, 1989). Accordingly, the evidence may be qualitative, quantitative or both. As this research strived to find out the challenges concerning SME development through the incubator, the case study method was appropriate.

Furthermore, Yin (2012) suggested that the case study approach be adopted in this kind of research because it is recognised as among the many ways of conducting social science investigation. Dana and Dana (2005) opined that some other methods are historical analysis, surveys, experiments, observation, and the analysis of archival documents. Yin (2009), postulate that each of this technique has its unique advantages, bearing in mind three conditions: (a) the kind of research question, (b) the control the researcher has over real behavioural activity, (c) the focus on present instead of historical event.

3.2 Sample Composition

The ten participants met the selection criteria and willingly agreed to participate in the study. The interviews were all conducted at a time and place convenient to the respondents. The longest interview lasted for 55 minutes while

the shortest interview lasted for 38 minutes. The average time for the interviews was one hour and three minutes. Table 4.1 below gives a depiction of the respondents' details. The youngest respondent was 38 years old, and the oldest was 53 years old. The average age of the respondents was 44.7.

Table 3.1: Participants demographics

No	Code	Gender	Position	Year of Experience	Qualification	Age
1.	IM1	Female	Incubator Manager	13	Ph.D.	48
2.	IM2	Male	Incubator Manager	8	Masters	43
3.	IM3	Male	Incubator Manager	10	Masters	44
4.	IM4	Female	Incubator Manager	7	Masters	43
5.	IM5	Male	Incubator Manager	5	Masters	37
6.	IT1	Male	Incubator Tenant	2	Vocational Training	42
7.	IT2	Male	Incubator Tenant	2	Diploma	49
8.	IT3	Female	Incubator Tenant	1	Vocational Training	38
9.	IT4	Male	Incubator Tenant	3	Vocational Training	39
10.	IT5	Male	Incubator Tenant	2	Diploma	36

3.2 Interview Analysis

This study's qualitative data was analysed employing inductive analysis as well as a particular method from the constant comparison technique were also utilised in performing the analysis (Yin, 2009) of the involvement of technology incubation managers and tenant business owners. Krathwohl (1998) posits that the constant comparative method encompasses the researcher in carrying out data analysis from the interview commencement. Yin (2012) added that initial data is coded to show the concept or dimension it represents, and the researcher connects concepts together into a theory, or explanation of the phenomenon studied. Qualitative data analyses entail comprehending the extent of making text and images meaningful in order to allow researcher to form responses to his research questions.

Creswell (2012) mentioned the six steps used in analyzing and interpreting the qualitative data. These steps are not always taken in sequence, but they represent preparing and organising the data for analysis; engaging in an initial exploration of the data through the process of coding it; using the codes to develop a more general picture of the data - descriptions and themes; representing the findings through narratives and visuals, making an interpretative meanings of the results and connecting the findings to the literature with the aim of validating the research findings. However, qualitative research is an iterative phase-like, meaning that you cycle back and forth between data collection and analysis by going back to your respondents to collect more information to fill in gaps in their stories as your analysis proceeds. Also it involves reading through the data several times and conducting an analysis each time. Each time you read your database you develop a deeper understanding about the information supplied by your respondents. Creswell (2012) indicated that several approaches are available to analysing qualitative data, although several guidelines exist for this process (see Miles & Huberman, 1994; Miles, Huberman, & Saldaña, 2014).

3.3 Manual Analysis

Despite the fact that the utilization of computer software for different goals is in recent past exceptionally well known, scholars still have an alternative to make about whether to do data analysis manually or employ software (Creswell, 2012; Miles & Huberman, 1994; Tesch, 1990). The employment of manual qualitative data analysis implies that researchers read the data, mark it by hand, and partition into parts. Generally, text data analysis includes utilizing colour coding to check parts of the text or cutting and pasting text sentences onto cards (Creswell, 2012). Evidence has shown that many researchers are comfortable with the manual approach to qualitative data analysis (Ajagbe, 2014; Ajagbe & Ismail, 2014). After the researcher has arranged and transcribed the data and made a decision on whether to analyse the data manually. This study finally settled for manual data analysis in view of the reasons expressed by past authors which were relied upon as a justification for manual analysis (Creswell, 2012; Miles & Huberman, 1994; Tesch, 1990).

3.4 The Interview

For the reason that the data collected take the form of recorded interviews, hence it was only possible to analyse them in its transcribed form. Thus all recorded interviews were transcribed by the researcher. After data collection, the researcher was faced with a huge amount of data. For the sake of organising the data, the literature was further reviewed and the data was summarised as suggested by Yang (2008). The transcribed interviews data, were coded. The coding which loosely adopted the Strauss and Corbin (1990) recommendation, detached segments of data on the basis of responses to related questions. As the open ended questions probed during the interview procedure were generally alike for all respondents, answers were similar enough in many cases to draw comparisons based on the responses generated by the respondents. The research did not take a look at word level analysis, as one of the predominant assumptions of the study has been the acceptance of answers. The study assumed that participants answered in an honest and realistic fashion. Through the process of constantly comparing data as well as categorization, during and after the data collection period; themes of major concern emerged from the data. Themes build upon each other to create a better understanding of the challenges faced by technology incubation programme in Nigeria from the perspective of incubation managers and tenants.

Table 4.1 shows the taxonomy of the barriers of technology incubation programme in Nigeria as grounded in the interview transcript.

Table 4.1: Taxonomy of the Barriers of TBI in Nigeria

Research Question	Main Themes	Sub-Themes
How do the barriers to success of Technology Business Incubation affect its performance in Nigeria?	Inadequate Funding	Low entrepreneurship development
	Inadequate Infrastructure	Low job creation
	Inadequate Business Support	Programme failure
		Business collapse
		Inconsistent polices
	Inconsistent Government Policy	Production reduction
		Inadequate infrastructural capability from the incubator management

4. Effect of the barriers to Technology Incubation Programme in Nigeria

4.1 Discussion of Themes

a) Inconsistent government Policy

The archetypal idea of the technology business incubation programme in Nigeria was to cause the transformation of research and development (R&D) results into products and services in the Nigerian economy. This has since been disrupted due to the shortage of research amenities in Nigeria and discrepancies in the way government

executes its policies. There are many laudable government policies from different regimes however, the application and uniformity towards the implementation of the initiative have been the despair of national industrialisation. Government each time puts forward one policy document or the other from time to time with different nomenclature but with the same intents and purposes as well as diverse procedures. The consequence of this is that so many initiatives that have laudable plans to be thrown away just for its successor to be doing the same thing with a different name and with different workforce. This has not indeed assisted the country in accomplishing the anticipated success in all these programmes comprising SMEs generally and technology incubation to be specific, as a result of changes and inconsistencies in the workforce as well as different objectives and perspectives of the plan.

The qualitative result shows that government policy can make or mar business incubation programme in Nigeria. Therefore, government policy has high importance attached to it. In line with this, if government want to move a particular sector of the economy forward, what it needs to do, is just to roll out policy document to that effect. Its role in business incubation is outstanding. Thus the study on government policy is consistent with (Greene, 2012; Mason & Brown, 2011; Minniti, 2008).

Furthermore, as policies make available strategic direction for any given programme of the government, unsuitable policy direction has been the weak spot for the technology incubation programme in Nigeria; it plans a course for the tactical and operational delivery of the initiative. Wrong policy direction has been a major obstacle affecting the effective provision of the technology incubation programme in Nigeria. This is deep-rooted by the absence of a national plan on the technology incubation programme. There is little or no reference of the technology incubation programme on the National Development Plan even in the existing Vision 20-20-20.

For the reason that a visible insight of the origin and crux of the programme will decide the policy direction and the modus operandi; whereas, a poor understanding will constantly cause an incongruity and misunderstanding with its associated consequence on application. However, all these can only be achieved through clear policy direction and complete manifestation of the technology business incubation programme. It is indeed high time the Technology Business Incubation in Nigeria is understood, practiced and implemented in the right fashion for the benefit of the Nigerian Economy and this can only be achieved through a sound policy direction.

Government policy is a very important aspect of entrepreneurship development and as such, can determine the success or failure of entrepreneurship development generally and business incubation programme to be specific. However, the success still depends on which side of the divides government leans

Funding

For the attainment of technology business incubation scheme, there should be a funding pattern by which the initiative will be constantly funded. The programme should be funded based on the policy document establishing the TI concept. The TBI funding stream should as a matter of urgency be multifaceted in operation. The Federal government that established the scheme should define the role played by each stakeholder in the scheme.

The basis for beginning technology incubation centres is to encourage the development of new businesses and greenhorn enterprises that have sufficient technology input and output. Therefore, it is necessitated to provide financial resources to the incubator in such a way as to make funding accessible to the entrepreneurs; unfortunately, incubators cannot on their own provide funds for the tenants. The reason is that the incubators are not making money on their own; they still depend on government subvention for their sustainability and as such cannot provide any financial assistance directly to the incubator tenants. This has made activities at the technology incubation centres very challenging to the point that the incubator management cannot render the rudimentary function put on the incubator. As the incubator cannot help the tenant firms directly, the incubator management usually attracts the other sources of funding for the tenants, for instance banks, venture capitalist, angel organization.

With regards to commercial banks, the entrepreneurs are discouraged by the stiff collateral imposed by banks which makes it difficult for them to be offered a loan facility. Concerning the venture capitalists, the TI programme lacks the venture capitalists that would ordinarily come in to help out; unfortunately, they seldom exist and if they

do exist, the venture capitalists would seldom invest in the newly-formed business enterprises. Also, angel organisations that are private high net-worth individuals would be skeptical about taking up some equity investment in the newly formed businesses.

Funding is almost like the backbone of any organisation, be it social organisation or business organisation. The impact of financial in any of these organisations is overwhelming. Finance play a very big role in entrepreneurship generally and TBI in particular. The reason being that without funds, the much needed facilities would not be available.

Business Support

The construct BS, the management assistance services used by the incubator management to provide the needs of the incubatees were investigated. By so doing, the study participants were requested to share their view points of how the barriers to the challenges incubation programme face affect the performance of the programme in Nigeria. The question investigates the attached to business support in contributing to the overall incubation performance. All the respondents acknowledged that BS is so important to the overall performance of the programme, while its absence or lack will portend doom for the programme. Majority of the respondents in the tenant firm category affirmed that the business incubator in which they operate are not really given them the much needed management assistance.

It has been noted that the reason associated with small business failure is because of the inadequate training or mentoring. Most small businesses at the beginning of their entrepreneurial life, more often than not lack the basic knowledge of business development, and other business support. Against this backdrop, business incubators usually make available all these cited business support services. It is assumed that business support is an important element for the attainment for small firms. The bottom line of business enterprises approaching the incubator is to acquire a number of those resources that enterprises cannot come up with. Consequently the coming of new start-ups to the incubators is to have access to these resources. Prior scholarly works have admitted the rationale for business support by incubators owing to the fact that a most of fledgling businesses do not have the required resources or critical capabilities for business success (Scarborough & Zimmerer, 2000; Shepherd & Shanley, 1998)

Similarly Business support or management assistance service is deemed an essential part of the incubation programme without which the fledgling businesses will not be nurtured. Without the nurturing of greenhorn businesses, there would not be the establishment of business incubators for the reason that the small inexperienced firms are the direct beneficiary of the programme.

Infrastructure

In the business incubation programme, the role of infrastructure is very significant due to the fact that most of the entrepreneurs who later came to the incubators did so for motive of the facilities which they cannot afford in their former place of work. Adequate infrastructure stemming from the sizable incubation unit, available ready-made alternative source of electric power vis-à-vis transformers as well as generators, water reticulation incubation unit, telecom facilities as well as road network within the incubation unit. On the converse, dearth of these infrastructures obviously impinges on the performance of the incubatees themselves who obviously rely on these facilities to be able to nurture their small businesses which are actually kept in incubation centre to be housed in an environment where they source infrastructure at low or no cost. When these infrastructures are not available, the incubatees will resort to the same little facilities they came to source in the first place. In a situation whereby there is inadequate or absence of infrastructures, incubation programme is often rendered redundant; thus entrepreneurship development will be affected. In view of this, a centre manager reiterated the need for adequate infrastructure across the incubation centres in the country.

5. Discussion on Findings

The findings of this evaluative qualitative study gives high importance to the role of government policy in harmonizing other elements of business incubation programme. As noted in the literature review that government is always in the lead of all entrepreneurship development and support. Despite the salient role of government

policy, respondents still take a swipe at the inconsistency of government policies. But overall, the importance of government policy cannot be overemphasised. Furthermore, consistent with the view that government policy is an important intangible resource that can enhance entrepreneurship by making a favourable environment for assisting the entrepreneurs in the incubators. It also strengthens the influence of business support and incubator performance relationship. In particular, there was a stronger relationship between business support and incubator performance with high government policy as opposed to low government policy. It can be concluded that favourable government policy is an essential condition for the performance of TBI programme. An entrepreneurial focused government policy will cause the sustenance and thriving of business incubation performance. This research suggests that government policy acted as a booster between business support and incubator performance, such that where there is high government policy or favourable government policy, there is likelihood for the performance of the incubator to increase. In other words, this finding suggests that when there is entrepreneurial friendly policy, there is likelihood of entrepreneurship through business incubator to get superior performance. The results provide support for the view that government policy moderates the relationship between business support and incubator performance. These findings are not surprising because they are consistent with Mohd Shariff, Peou and Ali. (2010). In addition, the study found government policy to moderate the relationship between financial resources and infrastructure respectively and incubator performance.

6. Conclusion and Recommendation

In conclusion, this study has shown that favourable government policy is an essential condition for the performance of Technology Business Incubation programme in Nigeria. Both the literature review and the empirical findings have shown how important government policy means to the development and performance of incubation programme.

On the basis of the findings of the empirical study, the researcher made several recommendations to guide business incubator managers and incubatees as well as government to enhance the creation of incubation programmes in Nigeria. The results of this study show that government policy influences the operations and practice of technology incubation programme. Government should as a matter of urgency develop a user friendly framework that will ease the difficulties incubators usually encounter in the course of providing resources to the incubatees. Government should begin to work towards developing incubation strategies that will contribute to the improvement of the programme, which will in turn will positively influence the performance of incubators.

References

- Abdullahi, M. S., Tahir, I. M., Aliyu, R. L., & Abubakar, A. (2015). Strengthening Small and Medium Scale Enterprises (SMEs) For Poverty Alleviation in Nigeria. *IOSR Journal of Humanities and Social Science (IOSR-JHSS)*, Volume 20 (6), 101-110.
- Agwu, M. O., & Emeti, C. I. (2014). Issues, challenges and prospects of small and medium scale enterprises (SMEs) in Port-Harcourt city. *European Journal of Sustainable Development*, 3(1), 101-114.
- Ajagbe, A. M. (2014). Funding Criteria in Technology Based Firms. *Universiti Teknologi Malaysia*.
- Ajagbe, M. A., & Ismail, K. (2014). Factors influencing venture capital assessment of high growth companies in Malaysia. *International Journal of Entrepreneurship and Small Business*, 21(4), 457-494.
- Akcomak, I. (2009). Incubators as Tools for Entrepreneurship Promotion in Developing Countries. Research paper No. 2009/52 in UNU-WIDER.
- Alese, O. J. (2017). Strategic management and the development of small and medium enterprises in south-west, Nigeria. An unpublished PhD Thesis of Olabisi Onabanjo University, Ogun state, Nigeria.
- Al-Mubarak, H., Al-Karaghoul, W., & Busler, M. (2010). The Creation of Business Incubators in Supporting Economic Developments. Paper presented at the European, Mediterranean & Middle Eastern Conference on Information Systems 2010 (EMCIS2010).
- Amit, R., & Schoemaker, P. J. (1993). Strategic assets and organizational rent. *Strategic Management Journal*, 14(1), 33-46.
- Ashford, N. A. (1993). Understanding technological responses of industrial firms to environmental problems: Implications for government policy. Paper presented at the Environmental strategies for industry: International perspectives on research needs and policy implications.

- Asiedu, E. (2006). Foreign direct investment in Africa: The role of natural resources, market size, government policy, institutions and political instability. *The World Economy*, 29(1), 63-77.
- Bagshaw, K. B. (2014). Power Supply Infrastructure and Government Policy Inconsistency on The Performance of Small and Medium Scale Manufacturing Firms In Nigeria: An Empirical Assessment. *AIJCSR*, 1(2).
- Chan, K., & Lau, T. (2005). Assessing technology incubator programs in the science park: the good, the bad and the ugly. *Technovation*, 25(10), 1215-1228.
- Creswell, J. W. (2012). *Educational research: Planning, conducting, and evaluating quantitative and qualitative research* (4 ed.). London: Pearson.
- Dana, L. P., & Dana, T. E. (2005). Expanding the scope of methodologies used in entrepreneurship research. *International Journal of Entrepreneurship and Small Business*, 2(1), 79-88.
- Dul, J., & Hak, T. (2008). *Case study methodology in business research*: Routledge.
- Eisenhardt, K. M. (1989). Building theories from case study research. *Academy of management review*, 14(4), 532-550.
- Greene, F. (2012). Should the focus of publicly provided small business assistance be on start-ups or growth businesses? (No. 12/2). Ministry of Economic Development, New Zealand.
- Guan, Q., Xie, X., & Zhou, J. (2015). The Influence of Government Policy on University Technology Transfer in China LISS 2013 (pp. 439-443): Springer.
- Ha, E., & Kang, M.-k. (2015). Government Policy Responses to Financial Crises: Identifying Patterns and Policy Origins in Developing Countries. *World Development*, 68, 264-281.
- Higgs, C. J., & Hill, T. (2019). The role that small and medium-sized enterprises play in sustainable development and the green economy in the waste sector, South Africa. *Business Strategy & Development*, 2(1), 25-31.
- Krathwohl, D. R. (1998). *Methods of educational and social science research: An integrated approach*: Longman/Addison Wesley Longman.
- Kumar, K. S., & Ravindran, D. S. R. (2012). A Study on Elements of Key Success Factors Determining the Performance of Incubators. *European Journal of Social Sciences*, 28(1), 13-23.
- Levitsky, J. (1996). *Support systems for SMEs in developing countries Small and Medium Enterprises Programme Vienna: United Nations Industrial Development Organization*.
- Mason, C., & Brown, R. (2011). Creating good public policy to support high-growth firms. *Small Business Economics*, 40(2), 211-225.
- Miles, M. B., & Huberman, A. M. (1994). *Qualitative data analysis: An expanded sourcebook* (2nd ed.). London: Sage Publications.
- Miles, M. B., Huberman, A. M., & Saldaña, J. (2014). *Qualitative data analysis: A methods sourcebook*: SAGE Publications, Incorporated.
- Minniti, M. (2008). The role of government policy on entrepreneurial activity: productive, unproductive, or destructive? *Entrepreneurship Theory and Practice*, 32(5), 779-790.
- Mohd Shariff, M. N., Peou, C. and Ali, J. (2010). Moderating effect of government policy on entrepreneurship and growth performance of small-medium enterprises in Cambodia. *International Journal of Business and Management*, 3(1), 57.
- NBIA. NBIA Publications Retrieved from <http://www.nbia.org>.
- Ojo, A. T. (2006). Using SMEs to Achieve Millennium Development Goals: Challenges and Prospects. *Covenant Journal of Business and Social Sciences*, 1(1), 20-35.
- Olutunla, G. T. (2005, July 7, 2008). Implementation of the small and medium industries equity investment scheme in Nigeria. Retrieved from <http://www.sbaer.uca.edu/research/icsb/2005/153.pdf>
- Onugu, B. A. N. (2005). *Small and medium enterprises (SMEs) in Nigeria: Problems and prospects*. St. Clements University, Nigeria (Unpublished Dissertation for a Doctor of Philosophy in Management Award).
- Osamwonyi, I. O., & Tafamel, A. E. (2010). Options for sustaining small and medium scale enterprises in Nigeria: Emphasis on Edo state. *African Research Review*, 4(3b).
- Patton, M. (2002). *Qualitative research & evaluation methods* (3rd Ed.). CA: Thousand Oaks, Sage.
- Pena, I. (2002). Intellectual capital and business start-up success. *Journal of intellectual capital*, 3(2), 180-198.
- Pergelova, A., & Angulo-Ruiz, F. (2014). The impact of government financial support on the performance of new firms: the role of competitive advantage as an intermediate outcome. *Entrepreneurship & Regional Development* (ahead-of-print), 1-43.
- Scarborough, N., & Zimmerer, T. (2000). *Effective Small Business Management: An Entrepreneurial Approach* (Vol. sixth). Upper Saddle River, New Jersey: Prentice-Hall.
- Shepherd, D. A., & Shanley, M. (1998). *New venture strategy: Timing, environmental uncertainty and performance*: SAGE Publications, Incorporated.
- Somsuk, N., & Laosirihongthong, T. (2014). A fuzzy AHP to prioritize enabling factors for strategic management of university business incubators: resource-based view. *Technological Forecasting and Social Change*, 85, 198-210.

- Strauss, A., & Corbin, J. M. (1990). *Basics of qualitative research: Grounded theory procedures and techniques*. Newbury Park: Sage Publications, Inc.
- Tesch, R. (1990). *Qualitative research: Analysis types and software tools*. Bristol, PA: Falmer Press.
- Theodorakopoulos, N., K. Kakabadse, N., & McGowan, C. (2014). What matters in business incubation? A literature review and a suggestion for situated theorising. *Journal of Small Business and Enterprise Development*, 21(4), 602-622.
- Yang, C. (2014). Government policy change and evolution of regional innovation systems in China: evidence from strategic emerging industries in Shenzhen. *Environment and Planning C: Government and Policy*, 32, 000-000.
- Yang, K. (2008). *Voice of the customer capture and analysis*. New York: McGraw Hill.
- Yin, R. K. (2009). *Case study research: Design and methods* (4th ed.). California: Sage publications.
- Yin, R. K. (2012). *Applications of case study research*: Sage Publication.



Empirical Testing of the Five-Factor Model of Fama and French in Indonesia as an Emerging Capital Market

Mustaruddin Saleh¹

¹Department of Management, Faculty of Economics and Business, Tanjungpura University, PONTIANAK.
Email: mustaruddin@gmail.com

Abstract

This study was conducted to empirically examine the five-factor model of Fama and French in respect to stock returns of companies listed in the finance sector with 170 observations over the period 2012-2016. As a comparative analysis, this study is also conducted to examine CAPM and the three-factor model of Fama and French. The findings of the study revealed that the market return has a positive and partially significant impact on the stock return for CAPM. Specifically, both variables, small minus big (SMB) and high minus low (HML) have a positive and significant impact on stock returns in the three-factor model and five-factor model of Fama and French. In contrast to the research of Fama and French the explanation power of the five-factor model is lower than that of the three-factor model in this research.

Keywords: CAPM, Three-Factor Model, Five-Factor Model, Stock Returns

JEL Classifications: G3, G11

1. Introduction

In an effort to minimize the investment risk faced by investors for each investment portfolio, various theoretical models have been developed to explain the relationship between risk and return. The first model introduced was the capital asset pricing model (CAPM). This model is based on the portfolio theory proposed by Markowitz, where each investor is assumed to diversify their portfolio and choose the optimal portfolio on the basis of their preference for the level of profit and risk. The CAPM was first introduced by Sharpa (1964), Litner (1965), and Mossin (1966) in the mid-1960s; the model was very popular, and many empirical studies were carried out. The results of many empirical studies support the CAPM. Some empirical results include the studies of Black, Jensen, and Scholes (1972), and Fama and MacBeth (1973). Black et al. (1972), who tested the CAPM using time series data and cross-sectional data, found a positive relationship between beta and excess return. Fama and MacBeth (1973) provided support for the previous study by confirming that there is a positive and significant relationship between beta and excess return.

However, other empirical tests revealed that investment risk cannot be determined by a single factor (beta). As the research conducted by Fama and French (1992), Asgharian and Hansson (1998), Hodhosima et al. (2004), and Sandoval and Saens (2004) stated that there is no significant effect between beta stocks and stock returns, this researcher concluded that other variables are needed as additional variables to explain the relationship between

risk and return. Thus, anomalies occur from the results of empirical testing of the CAPM. This is confirmed by the results of empirical studies that found that there is special volatility (Ang, Hodrick, Xing, and Zhang, 2006), liquidity risk (Pastor and Stambaugh, 2003), and momentum. As the results of the empirical studies above found that market beta is not able to explain the relationship between the rate of return and the risk of a securities portfolio, a multi-factor model was developed. This model, called the arbitrage pricing theory (APT) (Ross, 1976), stated that the return expectation of stocks might be influenced by several other sources of risk. This model is more efficient than the CAPM, and has been used extensively (Sudiyatno and Irsad (2011)). The research of Fama and French (1996) revealed that the book-to-market ratio, firm size, and market return affect stock returns. This model became known as the three-factor model of Fama and French. Furthermore, empirical testing using three factors has been widely used in capital markets in developed countries as well as developing countries. In 2000, Davis, Fama and French (2000) re-tested the three-factor model, and found that beta, size, and book-to-market ratio had a significant influence on stock returns (Bodie et al., 2005). Other empirical studies that also used this model, found varied results, with not all factors being able to consistently explain stock returns; for example, beta had no significant effect, and firm-size and book-to-market ratio had a significant effect in China (Drew et al., (2003)). Naughton and Veeraraghnavan's research found that only beta influenced and significantly affected stock returns in the three countries tested; namely, Indonesia, Taiwan, and Singapore (2005), while Charitou and Constantinidis (2007) found that the three variables, namely beta, firm size and book-to-market ratio had a significant effect on stock returns in the Japanese market.

The latest development is that Fama and French (2015) proposed two additional variables to their previous model; namely, the profitability variable and the investment patterns variable. Hence, the new model is called the five-factor model of Fama and French. This model tries to explain the relationship between these new variables with the stock returns expected using the discounted dividend model perspective and valuation theory. Empirical testing of this five-factor model has been tried by Nguyen et al. (2015) in the capital market in Vietnam. The results of their study showed that there were quite high anomalies compared to the traditional asset valuation models; namely, CAPM and the three-factor model of Fama and French (1993). Nguyen et al. found that entering variable profitability and investment factors, showed superior results compared to the CAPM and three-factor model of Fama and French. This study conducts an empirical study of the five-factor model of Fama and French (2015) on Indonesia's Stock Exchange, where, to the author's knowledge, there has been limited empirical testing. This is understandable because the five-factor model was only recently published by the researchers. This research is deemed necessary as a contribution to the empirical testing of asset valuation models using the five-factor model of Fama and French.

Based on the background described, the formulation of the problem in this study is as follows: (1). Can the variation in the rate of return of shares on Indonesia's Stock Exchange be explained by CAPM? (2). Can the variation in returns on shares on Indonesia's Stock Exchange be explained using the three-factor model of Fama and French? (3). Can the variation in the rate of return of shares on Indonesia's Stock Exchange be explained using the five-factor model of Fama and French?

2. Literature Review

The investment goal for every investor is to maximize returns, without forgetting the investment risk factors that must be faced. Return is one of the factors that motivates investors to invest and is also a reward for the courage of investors to bear the risk of the investment made. According to Eilly and Brown (2004: 4) investors invest funds from their savings and delay consumption to get a return on their investment. Investors will choose stocks that produce high returns with a high level of risk, and vice versa, stocks with low returns will have a lower risk.

1.1. Single Index Model

The single index model was developed by William Sharpe (1964), Lintner (1965), and Mossin (1966). According to Hartono (2014: 407) "a single index model is based on the observation that the price of a security fluctuates in the direction of the market price index." Stock prices tend to increase when the market price index increases, and vice versa. This shows that the profit level of a stock has a correlation with market changes (Husnan, 2001: 103).

The single index model uses beta in measuring the sensitivity of the level of profit of a security against the level of profit from the market (Hartono, 2014: 409). The bigger the beta of a stock, the greater the market risk.

The capital asset pricing model (CAPM) is a model that shows the relationship between the expected profit and the risk of a stock or portfolio as measured by beta. The advantage expected by investors is based on two things; namely, compensation from the time value of money and risk premiums (Breadley et al., 2007). So, the expected level of profit from a security in the CAPM model is the return of risk-free assets as compensation for the time value of money plus risk premiums or additional implied profits based on the systematic risk of a security. The CAPM is based on the portfolio theory built by Markowitz, which is based on the assumption that each investor will diversify their portfolio and choose the optimal portfolio according to their preference for return and risk.

1.2. Three-Factor Model of Fama and French

The findings from the results of empirical studies reveal that there are contradictory results from the CAPM. The results of the study question the accuracy of the CAPM, which considers that beta is the only variable that explains the expected stock return. The previous studies found that deviations from risk, as measured by beta with stock returns, were also influenced by other variables. These variables are firm size (Banz, 1981), company profits (Basu, 1997 and 1983), leverage (Bhandari, 1988), and the book value to market value ratio (B/M) (Stattman, 1980, Rosenberg et al., 1985; Chan et al., 1991). The results of the studies proved that there is a positive relationship between earnings, cash flow, and B/M ratio with stock returns, and a negative relationship between company size and stock returns.

The research of Fama and French (1992, 1993) showed that company size and the B/M ratio have an important role in explaining the difference in the expected rate of return on cross-sectional non-financial companies. Furthermore, Barber and Lyon (1997) found that the relationship between size, B/M ratio, and rate of return is the same for financial and non-financial companies. They recommended an alternative model. The evidence suggests that the proxy size of the company and the B/M ratio for the sensitivity of risk factors in the rate of return is consistent with rational-pricing for the role of company size in the average rate of return. The size of the company can be a proxy for the risk of negligence and B/M can be an indicator of the relative prospects of the company (Pasaribu, 2009). Cochrane (1996 and 2001) stated that the asset pricing models that use portfolio returns as a factor may be able to explain asset return rates adequately; however, they have only been able to explain these factors partially because this model still leaves unanswered questions regarding returns based on factors (Pasaribu, 2009). Company size and B/M ratio are variables outside the CAPM, and research uses them as additional variables to clarify the relationship between risk and return in the CAPM. The results of the study conducted by Fama and French (1992) revealed that the B/M ratio and company size have a strong influence on the average return on shares. So, by entering the variable company size and B/M ratio into the model, the model is known as the three-factor model of Fama and French (1996).

1.3. Five-Factor Model of Fama and French

Criticism of the CAPM through the use of strict assumptions has led to this model being rejected and difficulty in applying it in real conditions. However, without ignoring the large contribution of the model in financial research, several other models have been developed to strengthen the explanation between risk and the rate of return on securities. Among them are the introduction of the many factor model from Ross (1976), which is popular with the term arbitrage pricing theory (APT). However, the weakness of APT is that it cannot provide guidance concerning what factors are relevant in influencing the returns on a stock. Then a three-factor model was developed by Fama and French (1992), which added to the CAPM model by including the variable size of the company and the B/M ratio, thereby becoming a model of three factors – market returns, company size, and B/M ratio. Furthermore, Carhart (1997) further examined the Fama and French three-factor model by including the variable impact of stock performance in the past on stock performance in the future, which became known as the four-factor model. Carhart's model (1997) includes four variables in the model, market risk premium factors, firm size, B/M and momentum ratio, and winner minus loser (WML). His research findings stated that the four-factor model

can explain variations in portfolio returns based on past rates of return, and is consistent with the market model with four risk factors.

Multi-factor studies continue to be carried out by financial researchers, and the latest Fama and French (2015) research added two new variables to the three-factor model; namely, profitability and investment patterns. The two variables included were based on the results of various empirical studies that found that these two factors contributed to and affected asset returns (Hou, Xue, and Zhang, 2014; Novy-Max, 2013; and Titman et al., 2004). This model is known as the five-factor model of Fama and French. The results of the study by Fama and French (2015a and 2015b) showed that the ratio variable B/M places more emphasis on the explanation of the stock returns in the five-factor model. However, when testing on the international market, Fama and French (2015b) found that the five-factor model was more suitable for the North American and European markets and for large stock shares. Their findings also stated that there is a weak relationship for the rate of return of shares in the Japanese market. An empirical study with a five-factor model in emerging markets has been carried out by Nguyen et al. (2015) in the Vietnamese capital market. Their study found that the Fama and French five-factor model was better at explaining stock returns compared to the traditional CAPM model and the three-factor model. To the author's knowledge, no one has used the five-factor model of Fama and French for empirical studies in the Indonesian capital market. For this reason, this research is conducted to find empirical evidence to determine whether the new model provides a better explanation than the previous models.

2. Research Method

The population in this study is public companies listed in the Financial Sector of Indonesia's Stock Exchange for a period of 5 years from 2012 to 2016. The research samples were taken by purposive sampling. In the estimation method the regression model using panel data can be done through three tests; to compare the performance of the CAPM with the three-factor model of Fama and French, and the five-factor model from Fama and French. This method can use the ordinary least squares (OLS) approach or the least squares technique to estimate the panel data model. The regression equation can be written as follows:

$$\text{Single Index Model: } R_{i,t} = \alpha + \beta_i R_{m,t} + e_{i,t} \quad (1)$$

$$\text{Three-Factor Model: } R_{i,t} = \alpha + \beta_i R_{m,t} + \beta_i \text{SMB}_t + \beta_i \text{HML}_t + e_{i,t} \quad (2)$$

$$\text{Five-Factor Model: } R_{i,t} = \alpha + \beta_i R_{m,t} + \beta_i \text{SMB}_t + \beta_i \text{HML}_t + \beta_i \text{PF}_{i,t} + \beta_i \text{INVESTI}_{i,t} + e_{i,t} \quad (3)$$

Where:

$R_{i,t}$ = portfolio return in period t

$R_{m,t}$ = market return, shows the JCI return, calculated from the stock price index with (IHSG) period t , minus IHSG $t-1$ return.

$\text{SMB}_{i,t}$ = return on the factor "small minus big (SMB) in period t

$\text{HML}_{i,t}$ = return on high minus low, book to market period t .

$\text{PF}_{i,t}$ = return on the profitability factor, that is, by dividing net income after tax with the book value of shareholders in period t .

$\text{INVEST}_{i,t}$ = return on investment factor, which is calculated from the stock capitalization value circulating, and dividing investors into two groups; namely, the conservative investor group and the aggressive group of investors.

The regression coefficient here is very decisive as a basis for analysis, considering that this research is a fundamental method. This means that if the coefficient β is positive (+), then it can be said that there is a direct influence between the independent variable and the dependent variable. Each increase in the value of the independent variable will result in an increase in the dependent variable. Likewise, vice versa, if the coefficient of the value of β is negative (-), this indicates a negative influence where the increase in the value of the independent variable will result in a decrease in the value of the dependent variable.

This study uses panel data regression analysis, so the selection of estimation models can be done through three approaches: (1) common effect model using the ordinary least squares (OLS) approach or the least-squares technique to estimate the panel data model. (2) the fixed-effect model, which assumes that differences between individuals can be accommodated from the difference in intercepts. This estimation model is often called the least

squares dummy variable (LSDV) technique. (3) The random effect model which estimates panel data where interference variables may be interconnected between time and between individuals. The tests conducted to determine the right model can used a test tool, such as the (1) Lagrange multiplier test to find out whether the random effect model is better than the common effect method. (2) The Chow test or likelihood test for selection between the fixed effect models and common effects. Or (3) the Hausman test to choose whether the fixed effect model or random effect is the most appropriate to use.

3. Results and Discussion

3.1. Descriptive Statistics Analysis

Table 1 shows that the smallest value of the stock return rate, R_i , is 0.0001, while the highest value of R_i , is 0.5301. The average value of R_i is 0.0727, which means that the value that represents the R_i data is 7.27%. The standard deviation of R_i is 9.91%, which indicates that the average deviation of the data from the data on average stock returns is 9,91%. The highest monthly average return rate of 4.64% occurred in 2012. This proves that the economic situation at that time was in a good and stable condition, and, hence, the community could increase consumption and investment, which continued to increase the company's performance. The lowest rate of return of 0.89% occurred in 2013. The low monthly returns during the year were caused by less stable economic conditions, which had an impact on the declining company performance. If viewed per company, for five (5) years, the shares of three companies produced the highest monthly return in a row, these shares were those of PT. Atharvest Tbk, PT. Dayin Mitra Insurance, Tbk, and PT. Asuransi Harta Aman Pratama, Tbk, which were 30.21%, 14.44%, and 14.43%, respectively.

Table 1. Descriptive Statistics

	Minimum	Maximum	Mean	Std Deviation
	Statistic	Statistic	Statistic	Statistic
R_i	0.00010	0.53005	0.072704	0.099167
R_m	0.00030	0.01707	0.009690	0.005392
SMB	0.00100	0.54867	0.079004	0.094417
HML	-7.5100	-0.61000	-3.128500	1.172690
FP	-0.50339	0.50298	0.120973	0.007249
INVST	-0.52112	0.49268	0.029105	0.118912

The market rate of return (R_m) can be defined as the difference between the average of each month of all the shares with the rate of return of risk-free investment (risk-free rate). However, in this study, the market returns use the concept of reality returns, which are calculated based on historical data (Sudiyatno and Irsad, 2011). The lowest market return rate is 0.000030 or 0.03% and the highest is 0.01706 or 1.71%. The development of monthly market returns is volatile and tends to decline. The highest monthly market return occurred in 2014; namely, 1.70% and the lowest occurred in 2015, which was -0.97%. This indicates that Indonesia's economic development in 2015 experienced a relatively significant decline. Judging from the growth of monthly returns, the highest monthly returns for the 5 years study period occurred in February and March, which were 3.63% and 3.38%, respectively.

The results of the SMB descriptive statistics show that the smallest value is 0.0010, while the highest value of SMB is 0.5488. The average value is 0.0790, meaning that the value that represents the data is 7.90%. The standard deviation is 1.17%, which indicates that the average deviation of the data from the average SMB data is 9.44%. The size of the company (firm size) in this study is proxied by SMB (small big minus). SMB is the difference between the average of each month of returns on small stock portfolios or small companies with the average of each month of return on large stock portfolios or big companies. The other variables are presented in table 1.

3.2. Regression Test Result

In order to estimate the model with panel data, this study uses three alternative estimation models; namely, the common effect model (CEM), the fixed effect model (FEM), and the random effect model (REM). The third test results of the regression models used in the research are described in the following.

3.2.1. Regression test model 1: CAPM

The results of the t-test statistics for the CAPM model are shown below. The test results in Table 2 show that the market rate of return (R_m) has an effect on the rate of return of shares in CEM, and has a significant partial effect on FEM and REM. This means that the portfolio returns in this research model can be explained by market returns at a significance level of 10% ($\alpha = 10\%$).

Table 2. Regression Test Result for CAPM

	CEM	FEM	REM
C	0.0415*** (0.0000)	0.0973*** (0.0000)	0.0498*** (0.0000)
R_m	1.1197*** (0.0369)	-2.5376* (0.0520)	2.3622* (0.0607)
R^2	0.0219	0.2710	0.0146
F-stat	3.7549* (0.0543)	1.4762* (0.0620)	2.4929 (0.1162)
DW	1.9543	2.4813	1.7398
CHOW-test		1.5204* (0.0506)	
Hausman test			1.5369 (0.2151)
LM test	-	-	-

Notes: Dependent Variable: portfolio return in period, $R_{i,j}$; * $p < 0.10$; ** $p < 0.05$; and *** $p < 0.01$; Figures in parentheses are standard robust to heteroscedasticity using White corrected; DW-statistic is Durbin-Watson d -test for autocorrelation; number of observation is 170.

From the results of testing the three models above, regression testing using the random effect model (REM) is more appropriate because the results of the Chow-test are smaller than $\alpha = 0.10$ and those of the Hausman test are greater than $\alpha = 0.10$. The ability to vary the explanation of the independent variable on the dependent variable is very low (1.46 percent). This indicates that by using only one single variable in the CAPM model, the accuracy in explaining the effect of the relationship of the independent variable with the dependent variable is very limited.

3.2.2. Regression Testing Model 2: Three-Factor Model of Fama and French.

Table 3 above shows that from the three alternative models that appear, FEM is more appropriate for explaining the effect of the independent variable on the dependent variable in the three-factor model because the F value of the Chow-test and Hausman-test is smaller than $\alpha = 0.05$. The test results of the three factors from Fama and French, showed that two factors have a significant positive effect on stock returns; namely, company size (SMB) and book value to market value (HML). This shows that the test results on the SMB variable have a statistically positive and significant effect on stock returns. This means that if each growth in size and book value against the market value of the company's stock is 1, it will cause an increase in stock returns of 0.4019 and 0.6502. The results of this test partially support the research conducted by Pasaribu (2009), in which the SMB and HML variables have a positive and significant effect on the portfolio of returns on shares on the Indonesian Stock Exchange. However, this is different from the results of the research conducted by Sudyatno and Irsad (2011) who found that risk premiums; namely, market returns, have a positive effect and that two of the Fama and French factors cannot explain the behavior of stock returns in Indonesia.

Table 3. Regression Test Results for Three-Factor Model of Fama and French

	CEM	FEM	REM
C	-0.0023 (0.1640)	- 0.0124*** (0.0003)	-0.0052* (0.0892)
Rm	-0.3394** (0.0429)	0.2662 (0.2997)	-0.2200 (0.3415)
SMB	0.4313*** (0.0000)	0.4019*** (0.0000)	0.5599*** (0.0000)
HML	0.5788*** (0.0000)	0.6502*** (0.0000)	0.4583*** (0.0000)
R ²	0.9604	0.9777	0.9147
F-stat	1,342. 831*** (0.0000)	162.1691*** (0.0000)	593.5539*** (0.0000)
DW	1.6576	2.2434	1.8202
CHOW-test		5.0323*** (0.0000)	
Hausman test			7.9109** (0.0479)
LM test			

Notes: Dependent Variable: portfolio return in period, $R_{i,t}$; * $p < 0.10$; ** $p < 0.05$; and *** $p < 0.01$; Figures in parentheses are standard robust to heteroscedasticity using White corrected; DW-statistic is Durbin-Watson d -test for autocorrelation; number of observation is 170.

Furthermore, the F statistic test aims to test whether all the independent variables included in the model have a joint influence on the dependent variable (Ghozali, 2013: 98). The simultaneous test results show that the calculated F stat is 588,381 and that the F table (0.05; 3; 170) is 2.6049. The test results show that, together, Rm, SMB, and HML have a significant effect on stock returns. The coefficient of determination (R^2) is used to measure how far the ability of the model explains the variation of the dependent variable (Ghozali, 2013: 97). If the value of R^2 approaches one it means that the independent variables provide almost all the information needed in explaining the dependent variable (Rustiono, 2008). In Table 3 the coefficient of determination (R^2) is 0.914 and the adjusted R^2 is 0.912. In conclusion, the ability of Rm, SMB, and HML to explain stock returns is very high, which is equal to 91.20%, while the remaining 7.07% is influenced by other factors.

3.3.3. Regression Testing Model 3: Five-Factor Model from Fama and French.

The following is a test for the Five-Factor Model of Fama and French (2015) in the Indonesian stock market, especially in companies in the financial sector. The t-statistics on this model are presented in Table 4 below. Based on the results of testing the t-statistics in Table 4, the results that are consistent with the testing of the Fama and French three-factor model; namely, the two LnSMB and LnHML variables in this model, are also significant and positive in explaining the variability in stock returns on the Indonesian Stock Exchange. Thus, the profitability and investment factor variables in the Fama and French five-factor model do not provide empirical evidence explaining the rate of return of shares on the Indonesian Stock Exchange. The results of this test are in line with the study conducted by Nguyen, Ulku., and Zhang (2015), and Fama and French (2015a) who stated that profitability and investment variables do not fully explain the relationship with the portfolio of stock returns if combined in a five-factor model. The results of the F statistical test, show that they have an influence and are significant on the stock returns. Furthermore, the variability of the independent variables in explaining the dependent variable, stock returns, is 48.20%.

Table 4. Regression Test Results for Five-Factor Model of Fama and French

Variable	Model 1 (ROA)		
	CEM	FEM	REM
C	-0.0029* (0.0833)	- 0.0124*** (0.0003)	-0.0065** (0.0436)
Rm	-0.2719 (0.1090)	0.3281 (0.2554)	-0.1701 (0.4896)
SMB	0.4297*** (0.0000)	0.4147*** (0.0000)	0.5487*** (0.0000)
HML	0.5822*** (0.0000)	0.6299*** (0.0000)	0.4700*** (0.0000)
PF	-0.0295** (0.0281)	-0.0242** (0.0281)	-0.0146 (0.4967)
INVSTM	0.0089 (0.4414)	0.0093 (0.4439)	0.0326 (0.1363)
R ²	0.9684	0.9773	0.916
F-stat	1,006.766*** (0.0000)	148.5002*** (0.0000)	358.3975*** (0.0000)
DW	1.6292	2.1845	1.7850
CHOW-test		4.9621*** (0.0000)	
Hausman test			10.5258* (0.0616)
LM test			

Notes: Dependent Variable: portfolio return in period, $R_{i,t}$; * $p < 0.10$; ** $p < 0.05$; and *** $p < 0.01$; Figures in parentheses are standard robust to heteroscedasticity using White corrected; DW-statistic is Durbin- Watson d -test for autocorrelation; number of observation is 170

4. Conclusion and Suggestion

Based on the results of the data analysis and discussion in the previous section, the following conclusions have been derived. This study empirically tested the asset valuation models, the three-factor model of Fama and French, and the five-factor model of Fama and French on the portfolio of stock returns of financial sector companies on the Indonesian Stock Exchange. 34 companies were used as samples during the period of 2012 to 2016. The results of testing the CAPM model show that market returns have a positive and partially significant effect on the rate of return of shares of companies in the financial sector. The results of the testing of the three-factor model of Fama and French show that the Small Minus Big variable (SMB), as a proxy for company size (return), and the high minus low variable (HML), as a proxy for book value to market value (BE/ME), have a positive and significant influence on the rate of return of shares of companies in the financial sector. The results of testing the five-factor model from Fama and French show that only two of the five model variables; namely, the Small Minus Big variable (SMB), as a proxy for company size (Size), and the High Minus Low variable (HML), as a proxy for Book Value to Market Value (BE/ME), have a positive and significant effect on the rate of return of shares of companies in the financial sector. Variable market returns (Rm) in both models, namely, the three-factor model of Fama and French and the five-factor model of Fama and French did not affect the rate of return of shares of companies in the financial sector. In addition, the profitability factor (PF) and investment variable (Invst) in the five-factor model Fama and French have a negative effect but are not significant on the rate of return of shares of companies in the financial sector.

Based on the results of the data analysis of the three models in this study, the following are some of the suggestions given. As only two variables; namely, the SMB variable and the HML variable have a positive and significant influence on the three-factor model and the Fama and French five-factor model, it is recommended that investors make their investment decisions, prioritizing the companies which have a large size of return and a high ratio of book value of equity to the market value of equity. Considering that this research is limited to the use of a small

sample size and focuses only on the financial sector, it cannot be generalized to other sectors; hence, it is suggested that further research be conducted to expand the sample size and use various sectors of the stock market.

References

- Ang, A., Hodrick, R. J., Xing, Y., & Zhang, X. (2006). "The cross-section of volatility and expected returns." *Journal of Finance* 61, 259–299.
- Asgharian, Hossein & Hansson, Bjorn (1998). "Cross Sectional Analysis of the Swedish stock market." http://www.nek.lu.se/publications/workpap.Paper/WP02_19.pdf. diakses 23 Agustus 2016.
- Banz, Rolf W. (1981). "The Relationship Between Return and Market Value of Common Stock." *Journal of Financial Economics*. Vol. 9, pp. 3-18.
- Basu, S. (1997). "Investment Performances of Common Stocks in Relation to Their Price Earnings Ratios: A Test of the Efficient Market Hypothesis." *Journal of Finance*, Vol. 12, pp. 129-156.
- Basu, S. (1983). "The relationship between earnings yield, market value, and return for NYSE common stocks: Further evidence." *Journal of financial economics* 12, 129-156.
- Bhandari, L. (1988). "Debt/Equity Ratio and Expected Common Stock Returns: Empirical Evidence." *Journal of Finance*, 43: 507-528.
- Black, Fischer, Michael C. Jensen, Myron Scholes, (1972), The capital asset pricing model: Some empirical tests, in *Studies in the Theory of Capital Markets*. Jensen MC, ed. New York: Praeger. 79-121.
- Bodie, Z. Kane, A. & Marcus, A.J, (2005). "Investment". Terjemahan Zuliani D. Dan Budi Wibowo. Jakarta Salemba Empat.
- Carhart, Mark M., (1997), "On persistence in mutual fund performance," *Journal of Finance*, 52: 57-82.
- Chan, L.K.C., Hamao, Y., Lakonishok, J., (1991). "Fundamentals and stock returns in Japan." *Journal of Finance* 46, 1739–1789.
- Charitou, Andreas and Constantinidis, Eleni, (2004). "Size and Book-to-Market Factors in Earnings and Stock Returns: Empirical Evidence from Japan, (online), (<http://www.business.uiuc.edu/accountancy/research/vkz.center/pers/Charitou.pdf>). diakses 23 Agustus 2016.
- Damar Hardianto dan Suherman, (2007). "Pengujian Fama-French Three-Factor Model di Indonesia." *Jurnal Keuangan dan Perbankan*, Vol. 13, No. 2 Mei, Hal. 198-208.
- Davis James L., Eugene F. Fama, and Kenneth R. French, (2000), "Characteristics, covariances, and average returns: 1929-1997", *Journal of Finance*, 55:389-406.
- Dede Irawan Saputra, (2008). "Perbandingan Fama and French Three Factor Model dengan Capital Asset Pricing Model." *Jurnal Riset Akuntansi dan Keuangan*, Vol. 4. No. 2 Agustus, Hal. 132-145.
- Drew, Michael, E. Naughton, T., and Veeraraghavan, Madhu, (2003). "Firm Size, Book-to-Market Equity and Security Returns: Evidence from the Shanghai Stock Exchange." *Australian Journal of Management*, 28.2: 135-136.
- Fama Eugene F, and James D. MacBeth. (1973), "Risk, return, and equilibrium: Empirical tests." *Journal of Political Economy*. 81:607-636.
- Fama, E. F., & French, K. R. (2015a.) "A five-factor asset pricing model." *Journal of Financial Economics* 116, 1–22.
- Fama, E. F., & French, K. R., (2015b). International tests of a five-factor asset pricing model. Working Paper. Retrieved from SSRN: ssrn.com/abstract=2622782 . diakses 23 Agustus 2016.
- Fama, E.F., French, K.R. (1992). "The cross-section of expected stock returns." *Journal of Finance* 47, 427–465.
- Fama, Eugene F., (1996), "Multifactor portfolio efficiency and multifactor asset pricing," *Journal of Financial and Quantitative Analysis* 31, 441–465.
- Fama, Eugene F., dan Kenneth R. French. (1993). "Common risk factors in the returns on stocks and bonds." *Journal of Financial Economics* 33, 3-56.
- Gujarati, D. 2003. *Basic Econometric*. Mc-Grawhill. New York.
- Hodoshima, J. Garza, G.X. & Kimura, M. (2000). "Cross Sectional Analysis of Return and Beta in Japan." *Journal Economic and Business*, 515-553.
- Homsud, N., Wasunsakul, J., Phuangnark, S., and Joongpong, J, (2009). "A Study of Fama and French Three Factors Model and Capital Asset Pricing Model in the Stock Exchange of Thailand." *International Research Journal of Finance and Economics*, EuroJournals Publishing, Inc.
- Isna Yuningsih dan Rizky Yudaruddin. (2007). "Pengaruh Model Tiga Faktor Terhadap Return Saham". *Akuntabilitas*, September, Hal. 79-84.
- Jegadeesh, N., Titman, S. (1993). "Returns to buying winners and selling losers: implications for stock market efficiency." *Journal of Finance* 48, 65–91.
- Jogiyanto Hartono. (2003). "Teori Portofolio dan Analisis Investasi". Yogyakarta : BPFE Yogyakarta.

- Lintner, John. 1(1965). "The valuation of risk assets and the selection of risky investments in stock portfolios and capital budgets," *Review of Economics and Statistics* 47, 13-37
- Mossin, J. (1966). "Equilibrium in a Capital Asset Market." *Econometrica* 34(4), 768-783
- Nguyen Nh., Ulku N., and Zhang J. (2015). The Fama-French five factor model: Evidence from Vietnam. Working Paper.
- Novy-Marx, R. (2013). "The order side of value: The gross profitability premium.", *Journal of Financial Economics* 108, 1-28.
- Pastor, L., & Stambaugh, R. F., (2003). "Liquidity risk and expected stock returns." *Journal of Political Economy* 111, 642-685.
- Reilly, Frank, K., and Brown, Keith, (2004). "Investment Analysis and Portfolio Management." Seventh Edition, USA: South-Western.
- Rosenberg, B., Reid, K. and Lanstein, R. (1985). "Persuasive evidence of market inefficiency." *Journal of Portfolio Management* 11, 9-17.
- Ross, S, (1976). "The Arbitrage Pricing Theory of Capital Asset Pricing". *Jornal of Economic Theory* 13: 341-360.
- Sandoval, A. Eduardo & Saens, N. Rodrig., Author (2004). "The Conditional Relationship Between Portfolio Beta and Return: Evidence from Latin America," *Cuadernos de Economfa*, 41. 4:65-89.
- Sharpe, William F. (1964). Capital asset prices: A theory of market equilibrium under conditions of risk. *Journal of Finance* 19, 425-442.
- Stock Market". http://www.nek.lu.se/publications/workpap/Paper/WP02_19.pdf. diakses 23 Agustus 2016.
- Sudiyatno B., dan Irsyad M. (2011). "Menguji model tiga faktor Fama dan French dalam mempengaruhi return saham studi pada saham LQ45 di Bursa Efek Indonesia". *Jurnal Bisnis dan Ekonomi (JBE)* 18 (2): 126-136.
- Tandelilin E. ((2010). *Portofolio dan Investasi, teori dan aplikasi*. Edisi Pertama, Penerbit Kanisius, Yogyakarta.
- Titman, S., Wei, K., and Xie, F. (2004). "Capital investments and stock returns," *Journal of Financial and Quantitative Analysis* 39, 677-700.



Economic Valuation of Military Checkpoint-Induced Travel Time Variability in Abuja, Nigeria (2012-2017)

Ibrahim Gerarh Umaru¹, Abubakar Mohammed Tanko²

¹ Department of Economics, Kaduna State University, Kaduna-Nigeria

² Department of Economics, Nigerian Defence Academy, Kaduna-Nigeria

Correspondence: Ibrahim Gerarh Umaru. Email: ibrahim.umaru@kasu.edu.ng

Abstract

Between 2009 and 2016, Nigeria witnessed insurgency attacks from such militant groups as Movement for the Emancipation of Niger Delta (MEND), Movement for the Actualization of the Sovereign State of Biafra (MASSOB) and O'odua People's Congress (OPC). The most vicious and infamous threat yet was from the self-styled terrorist group going by the name, Jama'atuahlus-sunnah lid-da'awatiwal Jihad, otherwise known as Boko Haram. The group claimed responsibility for spate of bombings recorded not only within the north-east region of the country but on private and public buildings, bus stations, shopping malls, recreation centres and markets in major cities such as Kaduna, Kano and Abuja, Nigeria. The apparent threat to national security and perhaps most importantly to lives in these cities led security operatives, especially the Military and the Police, to erect checkpoints at strategic locations along major arteries and roads adjudged to be of strategic interest to the terrorists as one of the effective measures to curtail the activity of the terror groups. One of the fallouts of this measure is the phenomenon of obstruction of traffic and delays in reaching travel destinations by commuters often referred to in technical terms as travel time variability. Using the Nolan and Small (1995) modified economic valuation model and the erection of military checkpoints on the three highways in Abuja-Nigeria between 2012 and 2016 as reference points, this study examines the implication of the travel time variability in the federal capital territory (FCT). The findings of the study show that the mounting of military checkpoints might have cost the FCT between N8.25 and N9.58 billion annually within the period. For the period under study (2012 - 2016), the FCT economy might have lost between N40 and N59 billion to obstruction and traffic congestion occasioned by the mounting of military checkpoints.

Keywords: Military Checkpoint, FCT Highways, Travel Time, Time Variability, Start Time, Insurgency, Destination

INTRODUCTION

Since 2009 the Nigerian authorities have been battling the security threat posed by insurgency and terrorist groups Jama'atuahlus-sunnah lid-da'awatiwal jihad, (otherwise known as Boko Haram), Movement for the Emancipation of Niger Delta (MEND), Movement for the Actualization of the Sovereign State of Biafra (MASSOB) and O'odua People's Congress (OPC). The daring and systematic nature of the attacks compelled the implementation of certain counter-terrorism measures. A major strategy deployed by the Nigerian security apparatus was the establishment of military checkpoints along major highways and arterial roads to major cities. These checkpoints were intended

to assist the military in conducting surveillance using the stop and search system of motorists plying such roads and highways.

In the Federal Capital Territory, Abuja military checkpoints were mounted on the three major highways, namely, Nyanya-Keffi motorway, Murtala Mohammed (Kubwa-Zuba) expressway and Umar Musa Yar'adua (Airport Road) motorway. In spite of the intended benefit of mounting the military checkpoints in terms safety and physical security of road users, commuters may probably have found those checkpoints most inconveniencing because of the physical exhaustion, delays in arrival time to destination and additional economic costs that were often associated with them on a daily basis. What is more, when translated in monetary terms, all this may have had serious repercussions for the economy, especially for the period these checkpoints were enforced. Herein lies the rationale for studying the phenomenon of traffic congestion and the associated problem of travel time variability in the FCT.

The remainder of the paper is organized in three parts. The fourth part interprets the results. The third section outlines the methodology adopted for the study. The next section clarifies key concepts and reviews of extant literature. It also attempts to bring out the gaps in the literature. The last section forms the concluding part of the discourse.

LITERATURE REVIEW

Travel time can simply be defined as the expected time duration in which a commuter travels from one point to another. Commuter travel time could vary with respect to the schedule a commuter leaves home for office, business or leisure. A commuter has the possibility of departing on an early or late schedule. Biliyamin and Abosede (2012) define travel time variability in terms of how travel times vary over time (e.g., hour-to-hour, day-to-day, week-to-week). In general, travel time variability is the variability of scheduled travel time of a commuter from his/her departure to arrival point over the period of existence of established military checkpoints.

A number of factors are often responsible for the discrepancy between scheduled arrival and actual arrival times. One such factor is traffic congestion. Traffic congestion is defined as a condition on transport networks that occurs as use increases and is characterized by slower speeds, higher trip times and increased vehicular queuing (McKnight, Levison, Ozkay, Kamga and Paaswell, 2004). This is particularly typical with the physical use of roads by vehicles. Travel congestion or delay or jam can make trip times longer, and increases are queuing. Congestion may result from a decrease in capacity, accidents on the roads being closed, or delay or jam or even checkpoints mounted. What is critical about traffic congestion is that it imposes a substantial operational and monetary penalty on-road transportation by increasing the time required to provide service and commute from one point to another (McKnight, Levison, Ozkay, Kamga and Paaswell, 2004). In most heavily built-up cities, heavy traffic congestion is an everyday occurrence but largely as happenstance. It could, however, be the outcome of a deliberate action by the relevant security authorities to either forestall or counter an imminent breach of public peace or even restore tranquility to a troubled or war-torn area within their sphere of control. Such action could come in form of a police or military checkpoint.

A military checkpoint is a strategic position stationed on a road or pathway characterized by obstructive objects used to slow down or stop the movement of people and/or vehicles (FMI, 2004). Such checkpoints provide many advantages, including the ability to control how people enter the town/city so that security personnel can screen entrants to identify troublemakers (be they criminals, terrorists or simple rabble-rousers) and locate contraband items or lethal weapons such as improvised explosive devices (IEDs) (FMI, 2004).

The main impetus for time allocation and travel time variability draws its rationale from time allocation theory and theory of Consumer behavior. Travel behaviour and valuation of travel time have been explored for more than thirty (30) years by researchers from different perspectives. The theories of time allocation deal with the issue of time valuation. Many concepts of value of time emerge, depending on how a period of time is looked at; as a valuable resource, as something to be reassigned or as something to be reduced. Most researchers of this subject apply Consumer Behavior theory to develop models and explain the valuation of travel time savings.

Consumer theory models individual behavior as if what the individual does (consume) is governed by the search for satisfaction, which in turn is governed by his income. Becker (1965) had postulated the idea of 'final goods' as those which directly induce satisfaction. He paid attention to market goods and entered utility and time as a necessary input to prepare final goods. His main idea was that work time was, in fact, total time in a period minus preparation-consumption time. Johnson (1966) establishes that the reason behind a value of travel time equal to the wage rate was the absence of work time in the utility function. He shows that correcting this omission led to a value of time equal to the wage rate plus the subjective value of work (ratio between the marginal utility of work and the marginal utility of income). Johnson (1966) claims that this was the value of leisure, which in turn was equal to the value of travel time.

Oort (1969) suggests that travel time should be included in utility as well, and a third term appeared in the subjective value of travel time notion; namely, the value of the direct perception of travel time in utility. This is also intuitively attractive, as an exogenous reduction in travel time itself, which might make it even more attractive if travel is pleasurable in itself. De Serpa (1971) makes a significant input to the discussion of the value of time by introducing explicitly a set of technical constraints relating time and good. He postulates a utility function dependent on all goods and all time periods (which he called "activities"), including work and travel. He outlines two different concepts of time value within this framework. First is the value of time as a resource, which is the value of extending the time period, equivalent to the ratio between the marginal utility of (total) time and the marginal utility of income. The second is the value of time allocated to a certain activity (value of time as a commodity), given by the rate of substitution between that activity and money if the individual assigns more time to an activity than the minimum required.

The first to formulate a model for consumer behaviour in which utility depended only on time assigned to activities was Evans (1972). He criticizes Johnson's (1966) work because of the confusion between value of time and value of leisure. He also questions Oort (1969) who compared a reduction in travel time with an extension of the day. Finally Evans (1972) finds the possibility of a zero value for the marginal utility of income for individuals that earn money faster than their capability to spend it; thus, their time constraint is binding and the income constraint is not, which means an infinite value of time as a resource and an infinite value of saving time. Jara-Diaz (2000) remodels the works of Becker (1965), Johnson (1966), Oort (1969), and De Serpa (1971) and arrives at what he calls the 'subjective value of travel time' (SVTT).

Others present a different concept of value of time that flow from different theories of time allocation and came up with three components of value of saving travel time: the wage rate, the value of work and the value of travel as a commodity, and show what one obtains when the rate of substitution between travel time and travel cost is calculated from a utility function estimated from discrete travel choice models. The model highlights coincidences and differences showing that there has been an evolution towards a better understanding of the elements that determine money equivalencies for the variation in time assigned to activities. From a time value equal to wage rate for all activities, the model develops values that are activity-specific due to the introduction of new important elements in the underlying model for consumer behavior, affecting the arguments of utility and set of constraints.

Another major contribution to the work on travel time shows up in the work of Small (1982). He includes departure time as a variable, which influences utility, travel time and travel cost. The introduction of an institutional constraint that links departure time, working hours, and the wage rate generates a resource value of time that depends on work schedule. Therefore, a reduction in travel time induced by exogenous factors might favor a pleasurable rescheduling of activities. He, therefore, provides a more attractive framework to model the impact of travel time variability on arrival times. This he did by taking into account the consequences of arriving at destination earlier or later than desired and individuals choosing the time at which they depart. In his model, commuters adapt their behaviour to the presence of variable travel times by choosing earlier departure times.

Barely after a decade, Noland and Small (1995) developed a general framework that can be used to analyze total expected cost function of travel time. The basic idea behind this framework is to follow the economizing behaviour of an average commuter and determine the risk of arriving early or late to destination. They argue that essentially a traveler or commuter usually has a certain preferred time for arrival for his/her journey. The goal, therefore, is

to reach the destination by finding the optimal departure time from the start-point, given the estimations of values of schedule delay early and of schedule delay late. Their framework is so flexible that it explicitly recognizes the fact that travel time variability can assume different distributions in a day and the need to fit empirical data to the right distribution. Since this landmark publication, several attempts have been made to empirically measure travel time variability due to congestion and their associated cost. Such pioneering works include Alcantara de Vasconcellos (2004), Srinivasan and Rogers (2005), De Borger and Fosgerau (2006, 2008), Börjesson, Fosgerau and Algers (2009), Börjesson and Eliasson (2010), Beaud, Blayac and Stephen (2016), Wanjek and Hauger (2017), Buchel and Corman (2018).

Travel time variability research in Nigeria is of recent history. The available studies seem to concentrate mostly on merely estimating travel time variability, with only few of them attempting to identify and analyze the channels through which variability in travel time affects the economy. For instance, Olatunde (2016) carried a study on the impact of traffic congestion on commuters travel time in Lagos state. Its findings showed that the factors identified that influence traffic congestion in Lagos state were monetary cost, commuters scheduled time, road side and on-side parking, road side trading, total disregard for traffic regulations by road users and population of cars on the road. Similarly, Bilyamin and Abosede (2012) carry out a study on effects of congestion and travel time variability along Abuja-Keffi corridor in Nigeria. The study found that uncontrolled motorization is one of the major causes of traffic congestion along the outer ring corridor of Abuja due to the absence of adequate mitigation measures.

Another relevant study noteworthy is the Transport Secretariat of the Federal Capital Territory Administration/Nigerian Institute of Transport Technology (FCTA/NITT, 2009) conducted to analyze the vehicular and passenger traffic flow pattern and characteristics generated and attracted to Federal Capital City (FCC) in order to provide vital, up-date and reliable database for transport and traffic policy and planning programmes for FCC. The results of the study reveal that FCC attracts and generates vehicular traffic of 1,334,784 weekly. Out of these, 723,506 representing 54.2 percent are inbound traffic while 611,278 constituting 45.8 percent are outbound traffic; Out of the six entry and exit routes, Nyanya road records the highest vehicular traffic volume of 357,852. Out of this 54.8 percent are outbound while 45.2 percent are inbound. In terms of passenger traffic, FCC generated and attracted 9,017,712 passenger trips weekly. Out of this, 4,860,942 were inbound while 4,156,770 were outbound. Analysis of the hourly traffic flow reveals that 7.00am to 9.00am could be regarded as the morning peak period, while 8.00am to 9.00am with highest traffic flow could be regarded as morning peak hour for both passenger and vehicular traffic. The hours between 4.00pm and 6.00pm could be regarded as evening peak period for both passenger and vehicular traffic. However, 4.00pm to 5.00pm records the highest passenger trips of 886,025, which could be regarded as the evening peak hour. The route analysis also reveals that Nyanya road records the highest passenger trips of 2,962,877 followed by Kubwa road with 1,728,781. Mpape road recorded the least passenger trip in the city. A vehicular composition analysis of the city traffic reveals that cars are most dominant means of transportation in Abuja followed by minibuses. Although, commercial motorcycles have been banned in FCC, motorcycle traffic recorded some remarkable traffic volume of 27,447 on Keffi-Nyanya road.

Insightful as these studies might have been to our general understanding of urban transport infrastructure, traffic congestion and travel time, none has attempted to quantify in monetary terms the impact of the recent establishment of military checkpoints on Abuja highways and commuters' travel time as well as its impact on the local economy.

METHODOLOGY

Model Specification

This study adopts the Koster, Verhoef and Kroes (2008) approach of estimating expected cost function of travel time. This approach utilizes Noland and Small (1995) general framework which assumes that people make a trade-off getting to their destination between being late and being early which can be expressed as:

$$TEC = \alpha^*(T) + \beta^*(SDE) + \gamma^*(SDL) + \lambda^*(D) \quad (1)$$

where:

α = value of time for a traveller (VoT)

β = value of schedule delay early (*VSDE*)

γ = value of schedule delay late (*VSDL*)

T = travel time

SDE = schedule delay early

SDL = schedule delay late

TEC = total expected costs

D = Additional dummy taking a value of one if $SDL > 1$, to account for extra cost due to arriving late. The model also assumes that the distribution of travel times is not constant over time. The basic model can be briefly described as follows.

A traveller or commuter usually has a certain preferred time for arrival (*PAT*) on his/her journey. The goal therefore is to reach the destination by finding the optimal departure time (t_h) from the start-point, given the estimations of *VSDE* and *VSDL* and the travel time distribution. An intuitive feel of this can be likened to a scenario where the traveller decides when he/she wants to arrive at destination, and then decides when he/she would have to leave the start-point given all the 'troubles' to encounter during the trip.

If T denotes travel time, then the traveller is said to be late if $t_h + T(t_h, \theta) > PAT$, and early if $t_h + T(t_h, \theta) < PAT$ for a realization of T . The travel time T depends on the time that a traveller departs the start-point and other factors θ . To calculate the costs, the cost function is split into three parts:

$$TEC = EC^\alpha + EC^\beta + EC^\gamma \quad (2)$$

where:

$$EC^\alpha = \int_0^\infty \alpha * T * f(T) dT = \alpha * [E(T)] \quad (3)$$

which assumes a fixed distribution over time, with α being the value of time for a traveler and $E(T)$ the expectation of the travel time.

$$\begin{aligned} EC^\beta &= \int_0^{PAT-t_h} \beta * (PAT - T - t_h) f(T) dT \\ &= \int_0^{PAT-t_h} \beta * (PAT - t_h) * f(T) dT - \int_0^{PAT-t_h} \beta * T * f(T) dT \\ &= \beta * (PAT - t_h) * F(PAT - t_h) - \left[\int_0^\infty \beta * T * f(T) dT - \int_{PAT-t_h}^\infty \beta * T * f(T) dT \right] \\ &= \beta * (PAT - t_h) * F(PAT - t_h) - \beta * \left[E(T) - \int_{PAT-t_h}^0 T * f(T) dT \right] \end{aligned} \quad (4)$$

where the last integral is a part of the expectation since the integral is not starting at 0, but at $PAT - t_h$. If t_h is equal to PAT , which means a late departure time from home, the costs for being early tend towards zero because the chance of being early is zero, and the partial expectation is equal to $E(T)$.

$$\begin{aligned} EC^\gamma &= \int_{PAT-t_h}^\infty \gamma * (T - (PAT - t_h)) f(T) dT \\ &= - \int_{PAT-t_h}^\infty \gamma * (PAT - t_h) * f(T) dT + \int_{PAT-t_h}^\infty \gamma * T * f(T) dT \\ &= -\gamma * (PAT - t_h) * [1 - F(PAT - t_h)] + \gamma * \left[\int_{PAT-t_h}^\infty T * f(T) dT \right] \end{aligned} \quad (5)$$

The expected costs for being late tend to move in the reverse direction with the costs of being early. That is, if the traveller or commuter departs earlier from home, t_h will be smaller and the chance of being late would be smaller so that the first part of the costs decrease. The costs of being late are maximal if t_h is equal to PAT . In that case the integral is equal to the expectation $E(T)$. The optimal departure time can then be calculated using the first derivation of the total expected costs with respect to t_h when setting to zero. Koster, Verhoef and Kroes (2008) have argued that it is not quite safe to assume that travel time is independent of the departure from the start-point. However,

the closed-form total expected cost functions are really useful for application. In view of this, the travel costs can be computed for every departure time from the start-point, given a certain distribution and a preferred arrival time, and subject to choosing the departure time with the lowest costs.

Commuter time is affected by numerous factors, leading to uncertainty. The stochastic nature of those influencing factors which have been classified by van Oort, Sparing, Brands and Goverde (2015) as either internal or external factors leads to the discrepancy between scheduled and actual time of arrival at destination which is often perceived as unreliability and highly inconveniencing for commuters and other road users. Bates, Polak, Jones and Cook (2001) have found that a reduction in travel time variability is even more valuable to commuters than a reduction in travel time itself. Estimating travel time variability and its economic costs is therefore important for gaining knowledge of the deteriorations and ameliorations in daily traffic and for transport policy. Understanding travel time variability in reality however requires some knowledge of probabilistic distributions as they are capable of describing the nature and pattern of travel time variability. Understanding the distributions of travel time distribution is indeed a vital component for analyzing the cost of unreliability to commuters (Mazloumi, Currie and Rose, 2010; Buch el and Corman, 2018). Three theoretical probabilistic distributions have been suggested for empirically estimating the cost of travel time, namely exponential, Weibull and gamma distribution (Koster, Kroes and Verhoef, 2011). For a brief discussion of these distributions, see the Appendix.

Data and Methods

This study relied largely on primary data for analysis. Data were collected on the socio-demographics of respondents and information related to their travel routes, travel means, travel time and travel cost. Other specific information sought included those on their routine trips on the three major road arteries in the FCT, namely Umar MusaYar'adua expressway, Nyanya-Keffi expressway and Murtala Mohammed Expressway. As real-time collecting data on the three routes would be too overwhelming, a suitable sampling method of FCT residents was adopted for the study. The official census figures provided by National Bureau of Statistics (NBS, 2009) was used as the sampling frame, while the UNFPA (2014)'s projected population figures for the FCT and Yamane (1964) formula were employed to determine the sample size for the study as shown in Table 1.

Table 1: Sample size determination

Area council	2006 Population [†]		2014 Projected Population [‡]	Desired sample (d) = [x (c)/100]
	Number (a)	% of Total (b)		
Abaji	58,642	4.17	123,349.4	16
Abuja Municipal	776,298	55.2	1,633,762	220
Bwari	229,274	16.3	529,565	71
Gwagwalada	158,618	11.3	333,820.3	43
Kuje	97,233	6.9	204,631.9	26
Kwali	86,174	6.1	181,357.7	24
Total	1,406,239	100	2,959,507	400 [#]

Note:

$$\# - s = \frac{N}{3 + N(ME^2)} = \frac{2,959,507}{3 + 2,959,507(0.05^2)} = 399.84 \approx 400$$

Source:

[†] - NBS (2009)

[‡] - Projected based on NBS (2012)

A simple random sampling method and the random number table were used as sampling instruments. Thereafter, a multi-stage sampling procedure was followed to select the sample elements. To select 31 percent of the over 60 districts and major settlements in the FCT in identifying the streets and households to be interviewed, the Yamane (1964) was employed. Furthermore, to identify the appropriate sampling units in each settlement, the latter was

divided into four cardinal points and the allocated number per settlement was shared equally among the cardinal points. Then a simple random sampling method was used to identify specific households in the selected street to be interviewed. In particular, settlements with organized layouts, especially within the city centre, street numbers and neighbourhood identification were used as additional sampling frames. For unorganized settlements, the Umaru (2013) method of spinning a bottle after each sampling unit was identified and employed. The Statistical Package for Social Science (SPSS) 18 and E-views 9 were used to analyze data collected from the field.

The following eight-step procedure was used to analyze the data collected.

STEP 1: Total costs of travel time for periods before August 2015 and after August 2015 were determined.

STEP 2: Having estimated total costs of travel time for before August 2015 and after August 2015, the value of the travel T was estimated.

STEP 3: To determine if there were differences in travel time before and after 2015, the Chow Test was employed.

STEP 4: Data on other characteristics of commuters was analyzed.

STEP 5: Values of schedule delay early and schedule delay late were determined.

STEP 6: A probability distribution fitting to the observed travel times was undertaken.

STEP 7: The total expected cost in eq. (1), using the distribution of the outcome of Step 6 for every time period was calculated.

STEP 8: The overall total cost of travel time to the local economy was extrapolated based on FCT population and sample estimate of total cost of travel time.

DATA ANALYSIS

The basic socio-demographic characteristics of respondents are shown in Table 4.1. The table shows that public servants represented 48.3 percent of the total number of respondents while the least was the casual workers recording 3.8 percent. As for their educational attainment, respondents who indicated having completed tertiary education represented 77.2 percent whereas those with secondary school leaving certificates were a-fifth of the total number. Majority of the respondents were either married or living in a household characterized by extended family relationship. Further analysis of socio-demographics will reveal that majority (54.6 percent) of the respondents indicated they visited the city centre within the study area for work; followed by those on business (34.6 percent) and for leisure (6.4 percent). Respondents who commuted before and after August 2015 were in the majority (52.4 percent).

Further analysis of socio-demographic data from survey showed that about 81 percent of household members commute to city centre on routine basis. Further analysis revealed that the mean travel time for an average commuter was 108.209 minutes, schedule delay early 3.48877 minutes and schedule delay late 44.0083 minutes while the respective standard deviations were 32.9197 minutes, 3.65401 minutes and 23.4772 (Table 1).

Table 1: Socio-demographic statistics of respondents

SOCIO-DEMOGRAPHICS					
<i>Occupation</i>	<i>Student</i>	<i>Public Servant</i>	<i>Business</i>	<i>Casual W.</i>	<i>Contract</i>
	9.2	48.3	32.8	3.8	5.9
<i>Education Level</i>	<i>Informal</i>	<i>Primary</i>	<i>Secondary</i>	<i>Tertiary</i>	
	0.8	7.6	19.8	71.8	
<i>Purpose of Visit</i>	<i>Work</i>	<i>Business</i>	<i>Leisure</i>	<i>Other</i>	
	54.5	34.6	6.4	4.6	
<i>Currency of Visit</i>	<i>Daily</i>	<i>Weekly</i>	<i>Monthly</i>		
	88.3	4.6	7.1		
<i>Route</i>	<i>Airport</i>	<i>Kubwa</i>	<i>Nyanya</i>		
	27	17	56		

<i>Members of household who travel to city centre routinely</i>	<i>Age bracket</i>			
	20-30	31-40	41-50	51-60
	102	324	292	102
<i>Percentage of respondents who used the route</i>	<i>Before August 2015</i>		<i>After August 2015</i>	
	12		35.6	
			52.4	

SUMMARY STATISTICS

<i>Statistic</i>	<i>Travel time (T) in minutes</i>	<i>Schedule delay early (SDE) in minutes</i>	<i>Schedule delay late (SDL) in minutes</i>
<i>Mean</i>	108.209	3.48877	44.0083
<i>Median</i>	102.890	2.67000	39.6700
<i>Maximum</i>	205.670	21.3300	127.220
<i>Minimum</i>	45.6700	0.00000	2.00000
<i>Std. Dev.</i>	32.9197	3.65401	23.4772
<i>Sum Sq. Dev.</i>	420477	5087.024	213857.1
<i>Obs.</i>	389	382	389

Source: Author's survey, 2016

Noland and Small (1995) and Koster, Verhoef and Kroes (2007) have argued that the size of the total costs for the traveler depends on the risk probability distribution assumed for the study. So an important question is: which distribution results in the highest costs for the traveler and how much is the difference with the other distribution? Interestingly, this is an empirical matter. In order to determine which among the three optional cost-of-travel-time-variability models to use to analyze the empirical data for the study, the survey data was fit to various distributions - exponential, Weibull and gamma probability distributions) - using the QQ plot. Judging by how close the curve representing the actual curve mimicked the behaviour of empirical curve of the general total cost of travel time, it is easy from Figure 1 that, of three, the Weibull specification [(c) and (d)] performed best.

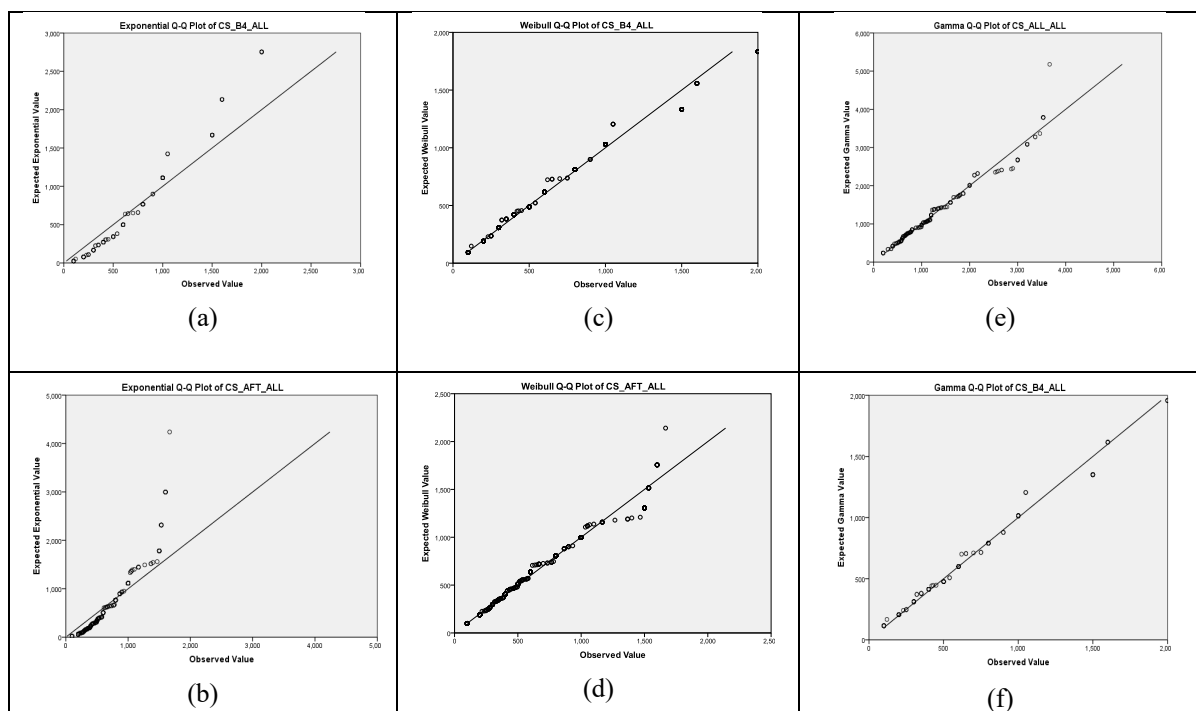

Figure 1: Distribution fitting (Exponential, Weibull and Gamma) for Travel time survey of FCT, 2015

Source: Author's survey analysis using SPSS Version 18

To determine the differentials in commuters' travel time and associated costs, the 'general' travel cost equation was estimated for 'before 2015', 'after 2015' and pooled time periods. The results are summarized in Table 2. The table shows that eight out of the twelve estimated coefficients had expected signs. Also, nine out of twelve regression coefficients were significant at 5 percent level. Other associated statistics vital for the Chow Test such as r-squared errors (R^2) and residual sum of squared errors (RSS) are shown in the lower part of the table.

Table 2: Results of the regression analysis

Variable	Before August 2015				After August 2015			
	Coef.	Std. Error	t-stat	Prob.	Coef.	Std. Error	t-stat	Prob.
Travel time	5.539	0.744	7.439	0.000	4.082	1.751	2.330	0.020
SDE	33.037	9.225	3.581	0.004	53.068	9.238	5.744	0.000
SDL	-1.893	2.569	-0.736	0.462	0.516	1.124	0.458	0.647
Dummy	375.97	78.728	4.775	0.000	489.59	78.75	6.216	0.000
R^2	0.002				-0.0047			
Ad. R^2	-0.005				-0.056			
S.E. Reg.	455.53				406.44			
RSS	79,890,964				62,445,216			
D-Watson	2.853				2.763			
Variable	Pooled (Before and After)							
	Coef.	Std. Error	t-stat.	Prob.				
Travel time	2.146	1.546	7.856	0.000				
SDE	-16.979	3.394	-5.001	0.000				
SDL	980.66	325.8	3.010	0.000				
Dummy	-164.76	183.2	-0.899	0.369				
R^2	0.061							
Ad. R^2	0.543							
S.E. Reg.	817.71							
RSS	88,432,678							
D-Watson	2.609							

Source: Author's survey analysis using SPSS Version 18

Performing the Chow Test which utilized the regression results in Table 1 as input was necessary as it helped to ascertain the feasibility of calculating the total expected costs of travel time in the study area. The results for the Chow are shown in Table 3. The calculated value of the F -statistic was 1,781. This was compared with the critical value of 3.32 for 387 and 778 degrees of freedom of RSS_R and RSS_{UR} respectively to arrive at the decision to reject the null hypothesis which stated that the military checkpoints on Abuja highways' associated costs travel time has changed between the two periods of study. Put differently, there was strong statistical evidence to suggest that the mounting of military checkpoints on Abuja highways had increased commuter travel time within the period under study. This conclusion seems to have been corroborated by the result of the additional test of equality of estimated variance as suggested by Chow (1960) and Gujarati and Porter (2009). Indeed, the value of the calculated F -statistic for differences in estimated variance was approximately 12.8, which is greater than its critical F -value (3.32).

Table 3: Chow test results

Symbol	Explanation	Restricted equation (R)	Unrestricted Equation (UR)
RSS	Residual sum of squared errors	256,000,000	274,233,618
n	Sample size	393	986

K	Number of parameters	4	4
df	Degrees of freedom	389	778
$F-Cc$	Chow's F -calculated		1,780.9
$F-C_T$	F -tabulated		3.32
$\hat{\sigma}_1^2$	Estimated variance of period (>2015)		209,324.72
$\hat{\sigma}_2^2$	Estimated variance of period (<2015)		15,970.641
$F-VC$	F -calculated for differences in estimated variances		12.793

Source: Author's survey analysis using SPSS Version 18

The Weibull and Gama risk distribution versions of eq. (3) were used to calculate the implication of total costs of travel time for the FCT. The summary results are reported in Table 4.

Table 4: SPSS 18 summary results of Weibull distribution estimation costs of travel time for an individual per trip in FCT Before and After 2012

Variable	<u>Before August 2014</u>		<u>After August 2014</u>		<u>Pooled</u>	
	Unstand'd	Stand'd	Unstand'd	Stand'd	Unstand'd	Stand'd
T	9.290	0.797	10.895	0.648	12.878	0.920
SDE	25.697	0.093	34.232	0.122	19.537	0.063
SDL	-11.093	-0.462	-12.195	-0.297	-15.875	-0.498
D	472.746	0.443	428.262	0.421	396.981	0.376
R^2	0.852		0.854		0.859	
$D-W$	2.676		2.715		2.668	

Source: Author's survey analysis using SPSS Version 18

Table 5 summarizes the total costs of travel time for households intervened in the survey. It represents the total costs of travel time for the 393 households surveyed in the FCT.

Table 5: Total cost of daily travel time for all the individuals over the survey sample in FCT (Weibull and Gamma distributions)

Cost	<u>Before August 2014</u>	<u>After August 2014</u>	<u>Change in Total Cost of Travel Time</u>
EC^a	252,693	347,479.58	94,786.58
EC^b	-594.95	-779.39	-184.44
EC^c	-266.97	-3,755.06	-3,488.09
TEC	251,831.07	342,945.14	91,114.05

Source: Author's computation based survey data analysis

As shown in Table 6, the projected population of FCT as at 2017 was 3,912,307. The cosmopolitan nature of the FCT characterized by high concentration of residential houses, administrative status of capital city, wholesale and retail outlets as well as the quest to access basic utilities have attracted people from all parts of the country might be some of the variables responsible for the growing population of the FCT. As a matter of fact, the concentration of business activities and the high vehicular traffic levels might have 'conspired' with the mounting of military checkpoints to fuel the incessant reoccurrence of traffic congestion in the city at peak periods.

Table 6: Projected population of FCT by Area Council, 2008 – 2017

Area Council	2011*	2012†	2013†	2014†	2015†	2016	2017
Abaji	93,309	102,406.6	112,391.3	123,349.4	135,376	148,575.2	163,061.2

AMAC	1,235,877	1,356,375	1,488,622	1,633,762	1,793,054	1,967,877	2,159,745
Bwari	365,007	400,595.2	439,653.2	482,519.4	529,565	581,197.6	637,864.4
Gwagwalada	252,522	277,142.9	304,164.3	333,820.3	366,367.8	402,088.7	441,292.3
Kuje	154,796	169,888.6	186,452.7	204,631.9	224,583.5	246,480.4	270,512.2
Kwali	137,190	150,566	165,246.2	181,357.7	199,040.1	218,446.5	239,745
TOTAL	2,238,751	2,457,029	2,696,590	2,959,507	3,248,059	3,564,745	3,912,307

NB: * National Bureau of Statistics, 2012

† Projected at 9.75 per cent growth rate used by National Bureau of Statistics (2012) for the period 2012 - 2017.

Results obtained from the survey sample show that, with an average of 4.5 household members commuted to and fro the city centre between 2012 and 2017. Based on the sample survey, about 43.83 percent household members were estimated to have visited the city centre daily within the study period. Given the projected population figures in Table 6 and ₦91,114.05 (US \$253.097) per/week as the net total cost of individuals travel time (Table 5), effort was made extrapolate the expected total costs associated with travel time variability between 2012 and 2017. First the average daily total cost an individual incurred due to travel time variability was determined as ₦231.84 (US\$0.644). Finally, the estimated annual average cost of mounting military check points on the FCT highways for the year 2012 was between ₦178 (US\$0.4944) million and ₦2,276 (US\$6.3222) million. In 2017, it rose to between ₦283 (US\$0.786) million and ₦3,624 (US\$90.6068) million. The total expected cost for the six years under study was ₦733.068 (US\$2.036) billion, meaning that within six years of mounting military checkpoint on three arterial highways, the local economy of FCT might have lost in excess of ₦700 (US\$1.9) billion.

Table 7: Estimated total expected costs of travel time variability due to military checkpoint in the FCT (2015-2017)

Statistic	2012	2013	2014	2015	2016	2017
<i>Projected population of FCT ('000)</i>	2,457.0	2,696.6	2,959.5	3,248.	3,564.8	3,912.
				1		3
<i>Total number of household members who commuted to city centre ('000)</i>	1,101.5	1,208.9	1,326.8	1,456.	1,598.1	1,753.
				1		9
<i>Mean total expected cost of travel time variability (TEC) in the FCT (₦million)</i>	1,137.3	1,248.2	1,369.9	1,503.	1,650.1	1,811.
				5		0
<i>Lower bound of mean TEC (₦million)</i>	177.9	195.3	214.4	235.3	258.2	283.4
<i>Upper bound of mean TEC (₦million)</i>	2,275.7	2,497.6	2,741.1	3,008.	3,301.7	3,623.
				4		6
<i>Total monthly TEC (₦million)</i>	7,961.4	8,737.6	9,589.6	10,500	11,600	12,700
<i>Total annual TEC (₦million)</i>	95,536.	104,851.	115,075	126,00	139,200	152,40
	8	2	2	0		0

CONCLUDING REMARKS

This study shows that the mounting military checkpoints on the FCT highways between 2012 and 2017 may have affected the economy of FCT adversely. For the period under study (2012 - 2017), the FCT economy may have lost over ₦730 billion to traffic congestion occasioned by the mounting of military checkpoint.

Any measure to minimize the significant negative externalities of increased traffic congestion on express motorways in FCT, and indeed Nigeria, must recognize the need to reduce commuters' travel time variability. In view of this, the following are recommended:

- a. There is the need to develop and deploy new approach to achieving security checking at checkpoint without unnecessarily creating more traffic congestion by security agencies, especially the military. In this regard, newer and modern surveillance technologies (radars, remote scanners and cameras) should be considered at such checkpoints. Also security and in particular military operatives should be trained in modern surveillance techniques.

- b. Alternative modes of transport should be considered so as to reduce the pressure on the major arteries leading to the city centre, such as intra-city train and/ tram systems.
- c. As this and other studies on commuters' travel time have shown, there is the need to integrate such studies in the environmental assessment process associated with road/transport planning and implementation by federal and state transport authorities. Such economic valuation of road/transport projects can serve as early warning systems as well as provide alternative measures in addressing increased traffic congestion whenever there is the need to mount such in the event of security challenges such as the one currently experienced by Nigeria.

References

- Alcantara de Vasconcellos, E. (2005). Urban change, mobility and transport in Sao Paulo: three decades, three cities. *Transport Policy*, 12(2), p.91-104.
- Bates, J., Polak, J., Jones, P. and Cook, A. (2001). The valuation of reliability for personal travel. *Transportation Research Part E: Logistics and Transportation Review*, 37(2): 191-229.
- Beaud, M., Blayac, T. and Stephen, M. (2016). The impact of travel time variability and traveler's risk attitudes on the values of time and reliability. *Transport Research Part B*, 93:207-224.
- Becker, G. (1965). A theory of the allocation of time. *The Economic Journal*, 75, 493-517.
- Biliyamin, I. A. and Abosede, B. A. (2012). Effects of congestion and travel time variability along Abuja-Keffi corridor in Nigeria. *Global Journal of Research In Engineering*, 12(3-E).
- Börjesson, M., and Eliasson, J. (2010). The value of time and external benefits in bicycle cost-benefit analyses. *Selected proceedings of the 12th WCTR*.
- Börjesson, M., Fosgerau, M. and Algers, S. (2009). The income elasticity of the value of travel time is not one number. In *European Transport Conference, 2009. Leiden Leeuwenhorst Conference Centre, Netherlands. 2009-10-5 to 2009-10-7*.
- Buchel, B. and Carman, F. (2018). Modelling probability distributions of public travel time components. 18th Swiss Transport Research Conference Monte Verita/Ascona, May 16-18, 2018.
- Chow, G.C. (1960). Tests of equality between sets of coefficients in two linear regressions. *Econometrica*, 28(3): 591-605.
- De Borger, B., and Fosgerau, M. (2006, August). Another test of the theory of reference-dependent preferences: the trade-off between money and time. In: European Transport Conference proceedings.
- De Borger, B., and Fosgerau, M. (2008). The trade-off between money and travel time: A test of the theory of reference-dependent preferences. *Journal of Urban Economics*, 64(1), 101-115.
- De Serpa, A. (1971). A theory of the economics of time. *The Economic Journal*, 81, 828-846.
- Evans, A. (1972). On the theory of the valuation of travel time savings. *Scottish journal of Political economy*, 19:1-17.
- FMI (2004). FMI 3-07.22: Counterinsurgency operations. October, 2004 (expires 1 October, 2006). Appendix C. *Population and resources control*. Available: www.GlobalSecurity.org. Accessed: 14/12/2016.
- Gujarati, D.N. and Porter, D.C. (2009). *Basic econometrics* 5th edition. Boston: McGraw-Hill.
- Jara-Díaz, S.R. (2000). "Allocation and valuation of travel time savings." *Handbook in Transport* 1(2000): 303-319.
- Johnson, M. (1966). Travel time and price of leisure. *Western economic journal* 4:135-145.
- Koster, P., Kroes, E., and Verhoef, E. (2008). Valuing the cost of car travel time variability. Working paper, VU University, Amsterdam, September, earlier version presented at the *Kuhmo Necter Conference*, Amsterdam, 2008
- Koster, P., Kroes, E., and Verhoef, E. (2011). Travel time variability and airport accessibility. *Transportation Research Part B: Methodological*, 45(10), 1545-1559.
- Mazloumi, E., Currie, G. and Rose, G. (2010). Using GPS data to gain insight into public transport travel time variability. *Journal of Transportation Engineering*, 136 (7): 623-631.
- McKnight, C.E., Levison, H.S., Ozkay, Kamga, K.C. and Paaswell, R.E. (2004). Impact of traffic congestion on bus travel time in northern New Jersey. *Transportation Research Record*. Available: www.citeseerx.ist.psu.edu. Access: 30/08/2017.
- Federal capital Territory Administration/Nigerian Institute of Transport Technology (FCTA/NITT, 2009). Final report on Abuja traffic and ridership survey. (Unpublished report)
- National Bureau of Statistics (NBS, 2012). *Annual abstract of statistics*. Abuja: National Bureau of Statistics.
- Noland, R. B. and K. A. Small (1995). Travel time uncertainty, departure time choice and the cost of morning commutes. *Transportation Research Record*, 1493, 150-158.

- Olatunde, R.A (2016). Impact of traffic congestion on commuter's travel time in Lagos state. A thesis of the department of economics, Nigerian Defence Academy Kaduna.
- Oort, O. (1969). The evaluation of travelling time. *Journal of Transport Economics and Policy*, 3:279-286.
- Small, K. (1982). Scheduling of consumer activities work trip. *America Economic Review* 72:467-479.
- Srinivasan, S., and Rogers, P. (2005). Travel behavior of low-income residents: studying two contrasting locations in the city of Chennai, India. *Journal of Transport Geography*, 13(3), 265-274.
- Tagaris, E. Liao, K.J., Delucia, A.J., Deck, L., Amar, P. and Russell, A.G. (2009). Potential impact of climate change on air pollution-related human health effects. *Environmental Science Technology* 1, 43(13): 4979-88.
- Umaru, I.G. (2013). *Research methodology: Principles and application in social and behavioral science*. Jos, Nigeria: Olive de L'Afrique Consult/Eiwa Ventures
- van Oort, N., Sparing, D., Brands, T. and Goverde, R.M.P. (2015). Data driven improvements in public transport: The Dutch example. *Public Transport*, 7(3): 369-389.
- Wajek, M. and Hauger, G. (2017). Reliability of travel time: Challenges posed by a multimodal transport participation. *IOP Guf. Series: Materials Science and Engineering*, 245 (2017).
- Yamane, T. (1964). *Statistics: An introductory analysis* 3rd edition. New York: Harpen and Row Publishing.

Appendix

In case of the exponential distribution with mean $pdf = \frac{1}{k} e^{-\left(\frac{T}{k}\right)}$ and standard deviation k it is possible to evaluate the integrals of EC^α and EC^β :

$$EC^\alpha = \int_0^{\infty} \alpha * T * f(T) dT = \alpha * E(T) = \alpha * k \quad (6)$$

$$\begin{aligned} EC^\beta &= \int_0^{PAT-t_h} \beta * (PAT - t_h) f(T) dT = \beta * (PAT - T - t_h) * \left[\frac{1}{k} * e^{-\left(\frac{-T}{k}\right)} \right] dT \\ &= \beta * \left[k * \left(-1 + e^{-\frac{PAT+t_h}{k}} \right) + PAT - t_h \right] \end{aligned} \quad (7)$$

$$\begin{aligned} EC^\gamma &= \int_{PAT-t_h}^{\infty} \gamma * (T + t_h - PAT) f(T) dT \\ &= \gamma * k * e^{-\frac{PAT+t_h}{k}} \end{aligned} \quad (8)$$

and the optimal travel cost determined as:

$$\begin{aligned} \frac{\partial TEC}{\partial t_h} &= -\beta + (\beta + \gamma) * e^{-\frac{PAT+t_h}{k}} = 0 \Rightarrow \frac{\beta}{\beta + \gamma} = e^{-\left(\frac{PAT-t_h}{k}\right)} \\ t_h^* &= PAT - k * \ln \left[\frac{\beta + \gamma}{\beta} \right] \\ TEC^* &= \alpha * k + \beta * k * \ln \left[\frac{\beta + \gamma}{\beta} \right] \end{aligned} \quad (9)$$

To estimate travel time with the Weibull distribution, the different parts of the total costs are as follows:

$$EC^\alpha = \int_0^{\infty} \alpha * T * f(T) dT = \alpha * \left[\lambda * Gamma \left[1 + \frac{1}{k} \right] \right] \quad (10)$$

$$EC^\beta = \beta * (PAT - t_h) * F(PAT - t_h) - \beta * \left\{ E(T) - Gamma \left[1 + \frac{1}{k}, \left(\frac{PAT - t_h}{\lambda} \right)^k \right] \right\} \quad (11)$$

$$EC^\gamma = \gamma * (t_h - PAT) * [1 - F(PAT - t_h)] + \gamma * E(T) * Gamma \left[1 + \frac{1}{k}, \left(\frac{PAT - t_h}{\lambda} \right)^k \right] \quad (12)$$

Setting the first derivative of the total expected costs to zero we obtain the condition:

$$\frac{\partial TEC}{\partial t} = e^{-\left(\frac{PAT-t_h}{\lambda}\right)^k} * \left\{ \left[1 - e^{-\left(\frac{PAT-t_h}{\lambda}\right)^k} \right] * \beta + \gamma \right\} = 0 \quad (13)$$

$$t_h^* = PAT - \lambda * \left(\log \left[\frac{\beta + \gamma}{\beta} \right] \right)^{\frac{1}{k}}$$

Should the empirical distribution to fit empirical travel time data turned out to be gamma distribution, the three parts of the expected total costs function to estimate are:

$$EC^\alpha = \alpha * E(T) = \alpha * k * \theta \quad (14)$$

$$\begin{aligned}
EC^\beta &= \beta * (PAT - t_h) * [1 - F(PAT - t_h)] - \beta * \left[E(T) - \int_{PAT-t_h}^{\infty} T * f(t) dT \right] \\
&= \beta * (PAT - t_h) * [1 - F(PAT - t_h)] - \beta * \left\{ E(T) - \frac{\theta * \text{Gamma} \left[1 + k, \frac{PAT - t_h}{\theta} \right]}{\text{Gamma}[k]} \right\}
\end{aligned} \tag{15}$$

where Gamma[a, b] is the incomplete gamma function. The costs for being late are derived:

$$EC^\gamma = \gamma * (t_h - PAT) * [1 - F(PAT - t_h)] + \gamma * \int T * f(T) dT \tag{16}$$

$$\gamma * (t_h - PAT) * [1 - F(PAT - t_h)] + \gamma * \left\{ \frac{\theta * \text{Gamma} \left[1 + k, \frac{PAT - t_h}{\theta} \right]}{\text{Gamma}[k]} \right\} \tag{17}$$

If the first derivative is set to zero, the following will result:

$$\frac{\partial TEC}{\partial t} \frac{\beta}{\gamma + \beta} = \frac{\text{Gamma} \left[k, \frac{PAT - t_h}{\theta} \right]}{\text{Gamma}[k]} = Q \left[k, \frac{PAT - t_h}{\theta} \right] \tag{18}$$

The three parts of the total cost function for the Lognormal distribution are:

$$EC^\alpha = \int \alpha * T * f(T) dT = \alpha * [E(T)] = \alpha * \left[e^{\mu + \frac{\sigma^2}{2}} \right] \tag{19}$$

$$EC^\beta = \beta * (PAT - t_h) * F(PAT - t_h) - \beta * E(T) * E(T) * (1 - \Theta[R(PAT - t_h)]) \tag{20}$$

$$EC^\gamma = \gamma * (t_h - PAT) * [1 - F(PAT - t_h)] + \gamma * E(T) * \Theta[R(PAT - t_h)] \tag{21}$$

where F(.) is the cumulative lognormal probability and E(T) the expectation. Setting the first derivative of the total costs function to zero yields the optimal t_h :

$$\frac{\partial TEC}{\partial t_h} = (\beta + \gamma) * \left[-F(.) + (PAT - t_h) * \frac{\partial F(.)}{\partial t_h} + E(T) * \frac{\partial \Theta(.)}{\partial t_h} \right] + \gamma = 0$$

so (22)

$$\frac{\gamma}{\gamma + \beta} = F(PAT - t_h) + \left(PAT - t_h \right) * f(PAT - t_h) - E(T) * g(PAT - t_h) * \left[\frac{1}{\sigma(PAT - t_h)} \right]$$

where F(.) is the cumulative distribution of the lognormal in $PAT - t_h$, f(.) is the probability of the lognormal in $PAT - t_h$, g(.) is the standard normal probability evaluated at $PAT - t_h$.



Leadership: A Comprehensive Review of Literature, Research and Theoretical Framework

Sait Revda Dinibutun¹

¹ Assistant Professor of HRM, College of Business Administration, American University of the Middle East, Kuwait

Correspondence: Sait Revda Dinibutun, College of Business Administration, American University of the Middle East, Dasman, 15453, Kuwait. Tel: +965 2225 1400/1576. E-mail: sait.revda@aum.edu.kw

Abstract

This paper provides a comprehensive literature review on the research and theoretical framework of leadership. The author illuminates the historical foundation of leadership theories and then clarifies modern leadership approaches. After a brief introduction on leadership and its definition, the paper mentions the trait theories, summarizes the still predominant behavioral approaches, gives insights about the contingency theories and finally touches the latest contemporary leadership theories. The overall aim of the paper is to give a brief understanding of how effective leadership can be achieved throughout the organization by exploring many different theories of leadership, and to present leadership as a basic way of achieving individual and organizational goals. The paper is hoped to be an important resource for the academics and researchers who would like to study on the leadership field.

Keywords: Behavioral Approach, Contemporary Theories, Contingency Theories, Leadership, Servant Leadership, Trait Theories, Transactional Leadership, Transformational Leadership

1. Introduction

In order to attain organizational effectiveness, organizations have shifted away from the use of hierarchical structures and individualized jobs, and implemented team-based work structures. This implementation has increased the importance of individual initiative and cooperation (Le Pine, Erez, & Johnson, 2002). Therefore, in today's complex business world, one of the major concerns of organizations is motivating employees for initiative and cooperation in order to attain effective organizational functioning (Le Pine et al., 2002).

The concept of leadership has evolved and developed due to numerous organizational and environmental changes (Alonderiene & Majauskaitė, 2016). Several studies have been carried out to assess the effect of leadership on the performance of organizations and how organizational variables such as culture, employee effectiveness, satisfaction, performance, retention, and motivation are influenced by various leadership styles (Shaw & Newton, 2014; Siddique, Aslam, Khan, & Fatima, 2011; Yang, 2014; Yang & Islam, 2012).

The literature is very rich with theories about leadership in general. It has been a major topic of research in psychology, which has spawned thousands of empirical and conceptual studies (Zaccaro & Klimoski, 2001). According to Yukl's (1989) study, most leadership researches suggest that leadership is an important determinant of organizational effectiveness. Leaders can significantly affect individual, group, and organizational performance (Ilies, Nahrgang, & Morgeson, 2007). Effective leaders influence individuals and groups so that they are willing to perform beyond the minimum levels required by the organization (Ilies et al., 2007; Podsakoff, MacKenzie, Moorman, & Fetter, 1990).

This paper aims to give a brief and clear understanding of leadership and theories of leadership in order to form the most effective leadership type.

2. Definition of Leadership

Leadership is mostly defined as the process of influencing a group toward the achievement of goals and directing the organization to make it more cohesive and coherent (Bass, 1997). A leader carries out such a process by applying his/her leadership qualities, such as values, beliefs, character, knowledge, skills, ethics, experience, and culture. Leaders inspire people, move them to action and change the world. Leadership is a social process that is highly complex.

Leadership includes influence processes involving determination of the group's objectives, motivating task behavior in pursuit of these objectives, and influencing group maintenance and culture (Yukl, 1989). Burns (1978) defined leadership as: "inducing followers to act for certain goals that represent the values and the motivations, the wants and needs, the aspirations and expectations of both leaders and followers." Table 1 summarizes the defining statements on leadership by researchers, which cover more than one century of academic work on the subject.

Table 1: Definitions of Leadership

Researchers	Definition of Leadership
Blackmar (1911)	It is the centralization of effort in one person.
Bernard (1927)	It focuses the attention of group members into the desired direction.
Copeland (1942)	It is the art of influencing.
Knickerbocker (1948)	It consists of a relationship between an individual and a group.
Stogdill (1950)	It is the process of influencing the activities of an organized group in its effort toward goal setting and goal achievement.
Bennis (1959)	It induces a subordinate to behave in a desired manner.
Bass (1961)	It is an individual's effort to change the behavior of others.
Tannenbaum (1961)	It is interpersonal influence toward the attainment of a specified goal or goals.
Katz and Kahn (1966)	It is an influential increment over and above compliance with the routine directives of the organization.
Burns (1978)	It transforms followers, creates visions of the goals that may be attained and articulates for the followers ways to attain those goals. Leadership persons mobilize resources to arouse, engage and satisfy the motives of followers.
Pondy (1989)	It is a form of social influence.
Schein (1992)	It is the ability to start evolutionary change processes that are more adaptive.
Bass (1994)	It is an interaction and leaders are agents of change whose acts affect other people more than people's acts affect them.
Drucker (1998)	It needs a leader. The only definition of a leader is someone who has followers.
Vroom and Jago (2007)	It refers to a potential or capacity to influence others.
Jung (2013)	It is the alignment of subordinates' activities and their motivational activation for goal attainment.

Source: Self-created

Review of the literature reveals three primary components to any leadership situation bound together by a concept of dynamic interaction between: the leader; the follower(s); and the context, environment, or situational aspect of their surroundings. The capable leader is one who knows how to capitalize on the potentialities inherent in his or her own personality, his or her subordinates, and the situation. From this perspective, leadership can be viewed as the ability to involve others in the process of accomplishing a goal within some larger system or environment.

3. Leadership Theories

Leadership is a social phenomenon that is found everywhere. People always are attracted by legends and myths about what distinguishes great leaders from followers (Den Hartog & Koopman, 2001).

Several main trends can be discernible in the development of the study of leadership. While early theories tend to focus on the characteristics and behaviors of successful leaders, later theories begin to consider the role of followers and contextual nature of leadership (Bolden, Gosling, Marturano, & Dennison, 2003).

Over the years there have been a number of theories addressing the understanding of leadership, including great man theory, trait theory of leadership, behavioral theories, contingency theories, and contemporary leadership theories as charismatic leadership, transformational leadership, transactional leadership, and servant leadership theory.

3.1. Great Man Theory and Trait Theory

The Great Man approach is a leadership perspective that sought to identify the inherited traits leaders possessed that distinguished them from people who were not leaders (Daft, 2018). It assumes that the capacity for leadership is inherent – that great leaders are born, not made. The term ‘Great Man’ was used because leadership was conceptualized as a single ‘Great Man’ who put everything together and influenced others to follow along based on inherited traits, qualities, and abilities.

Trait theory assumes that people inherit certain qualities and traits that make them better suited to leadership. Traits are the distinguishing personal characteristics of a leader, such as intelligence, honesty, self-confidence, and appearance (Daft, 2018). A large number of personal traits and abilities have been associated with successful leaders, but traits themselves are not sufficient to guarantee effective leadership. Natural traits and behavior patterns can be developed into strengths. It is important for leaders to recognize their strengths and acknowledge the interdependence that is a key to effective leadership.

Trait research has been part of leadership studies conducted since the 1940s. Findings suggest that some traits are essential to effective leadership when other factors are present. Table 2 presents some of the traits and their respective categories that have been identified through trait research over the years.

Table 2: Studies of Leadership Traits and Characteristics

Stogdill (1948)	Mann (1959)	Stogdill (1974)	Lord, DeVader and Alliger (1986)	Kirkpatrick and Locke (1991)
Intelligence	Intelligence	Achievement	Intelligence	Drive
Alertness	Masculinity	Persistence	Masculinity	Motivation
Insight	Adjustment	Insight	Dominance	Integrity
Responsibility	Dominance	Initiative		Confidence
Initiative	Extroversion	Self-confidence		Cognitive Ability
Persistence	Conservatism	Responsibility		Task Knowledge
Self-confidence		Cooperativeness		
Sociability		Tolerance		
		Influence		
		Sociability		

Source: *Leadership: Theory and Practice*, P.G., Northouse. 2004, Oaks: Sage Publications, Inc.

Researchers who pursue a trait approach to leadership assume that leaders are different from other people, and that there must be some deeper traits which cause some people to become leaders (Hampton, Summer, & Webber, 1978). The general approach was to compare leaders to non-leaders to see what differences existed with respect to different kinds of traits. The theory seemed valid for a time, but when it was recognized that leaders who didn't have those traits could always be found, another group of researchers began to concentrate on the behaviors of leaders.

3.2. Behavioral Theories

After World War II, research emphasis shifted from personality traits to a search for behavior that makes a difference in the performance or satisfaction of followers. Contrary to trait theories, leadership was viewed as an observable, personal characteristic. The theories developed at that time were called '*behavioral theories*' as they emphasized the leader's behavior. According to this theory, people can learn to become leaders through teaching and observation. As Den Hartog and Koopman (2001) stated, the focus shifted from whom leaders are to what leaders do.

Behavioral theories' main theme is that leaders become successful and effective according to what they actually do – *behaviors* – when they are dealing with subordinates. Researchers focused on understanding the relationship between how the leaders behave and how the subordinates react emotionally – i.e. satisfaction – and behaviorally – i.e. performance (Feldman & Arnold, 1983). As an outcome of these studies, a variety of leadership styles are determined. The studies which are involved in behavioral approach are; University of Iowa Studies, Ohio State University Studies, University of Michigan Studies and University of Texas Study – The Leadership Grid.

3.2.1. Autocratic versus Democratic Behaviors

Autocratic is a leader who tends to centralize authority and derives power from position, control of rewards, and coercion, whereas *Democratic* is a leader who delegates authority to others, encourages participation, relies on subordinates' knowledge for completion of tasks, and depends on subordinate respect for influence (Daft, 2018).

3.2.2. University of Iowa Studies

The first studies on autocratic versus democratic leadership behaviors were conducted at the University of Iowa by Kurt Lewin (1939). The research included groups of children, each with their own designated adult leader who was instructed to act in either an autocratic or a democratic style.

Studies showed that the groups with autocratic leaders performed well when the leader supervised them. However, group members were displeased with the autocratic style of leadership, and feelings of hostility arose. Groups assigned to democratic leaders performed almost as good, and these groups were characterized by positive feelings rather than hostility. In addition, under the democratic style of leadership, group members performed well even when the leader was absent. Participative techniques and majority-rule decision-making used by the democratic leader trained and involved the group members to perform well with or without the leader present. The University of Iowa studies found that leadership behavior had a definite effect on follower performance and satisfaction.

This early work implied that leaders were either autocratic or democratic in their approach. Further work by Tannenbaum and Schmidt (1973) indicated that leadership behavior could exist on a continuum reflecting different amounts of employee participation. Thus, one leader might be autocratic (boss-centered), another democratic (subordinate-centered), and a third a mix of the two styles, as shown in Figure 1 (Tannenbaum & Schmidt, 1973).

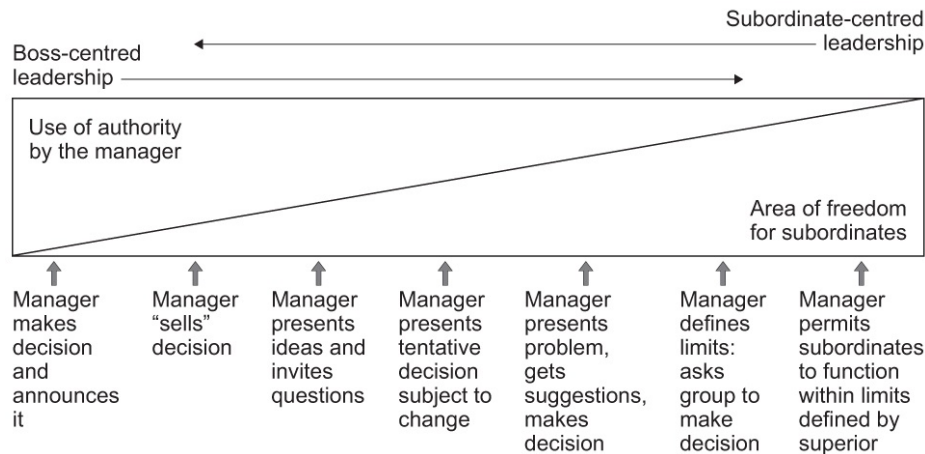

Figure 1: Leadership Continuum

Source: *Harvard Business Review*. An exhibit from Robert Tannenbaum and Warren Schmidt, "How to Choose a Leadership Pattern" (May–June 1973).

Tannenbaum and Schmidt (1973) suggested that the extent to which leaders should be autocratic or democratic depended on organizational circumstances and that leaders might adjust their behaviors to fit the circumstances. For example, if it takes too long for subordinates to make decisions, the leader will use an autocratic style. If subordinates can learn decision-making skills readily, a democratic style can be used. Also, the greater the skill difference, the more autocratic the leader approach, because it is difficult to bring subordinates up to the leader's expertise level (Heller & Yukl, 1969).

3.2.3. Ohio State University Studies

The Ohio State University Leadership Studies focused on how leaders could satisfy common group needs (Daft, 2018). As a result, two important dimensions of leader behavior were identified; *consideration* and *initiating structure*. Consideration is the extent to which a leader is sensitive to subordinates, respects their ideas and feelings, and establishes mutual trust. A leader who is high in consideration helps group members with personal problems, is friendly and approachable, and treats all group members as equals (Yukl, 1989). Initiating Structure is the extent to which a leader is task-oriented and directs subordinates' work activities toward goal achievement. A leader who is high in initiating structure directs tasks, plans, and rules with an iron hand (Bass, 1990).

The studies found that a leader who was high in both initiating structure and consideration – a *high-high leader* – achieved high group task performance and satisfaction more frequently than one who rated low on either dimension or both. In the studies of Ohio State University, a questionnaire was developed which was called Leader Behavior Description Questionnaire (LBDQ) (Hemphill & Coons, 1957).

3.2.4. University of Michigan Studies

The studies directly compared the behavior of effective and ineffective supervisors. The effectiveness of leaders was determined by productivity of the subordinate group (Daft, 2018). Two types of leadership behavior were established: *employee-centered* and *job-centered*. Employee-centered is a leadership behavior that displays a focus on the human needs of subordinates. It deals with each employee, thinking that every employee is important and has personal needs. Job-centered is a leadership behavior in which leaders direct activities toward efficiency, cost-cutting, and scheduling, with an emphasis on goals and work facilitation. It focuses mostly on production and technical subjects, and it sees employees as tools for reaching company goals (Blanchard, Spears, & Lawrence, 2001).

The Michigan University researchers concluded that the employee-centered leaders were more effective as they were associated with high group productivity and high job satisfaction (Robbins & Coulter, 2005). Unlike Ohio State University Studies, according to Michigan Studies, leaders could be employee-centered or job-centered, but not both. Performance was also influenced by other factors related to the situation.

3.2.5. University of Texas Study – The Leadership Grid

The Leadership Grid Model developed by Robert Blake and Jane Mouton (1985), from the University of Texas, is famous for its explanations about organizational leadership. This model focuses on two dimensions of the leader's behaviors, namely *concern for people* and *concern for production*. Concern for people is the degree to which a leader considers the needs of team members, their interests, and areas of personal development when deciding how best to accomplish a task. Concern for production is the degree to which a leader emphasizes concrete objectives, organizational efficiency and high productivity when deciding how best to accomplish a task (Blake & Mouton, 1985).

The model identifies five different leadership styles based on the concern for people and the concern for production. The model is represented as a grid with concern for production as the X-axis and concern for people as the Y-axis; each axis ranges from 1 (Low) to 9 (High). The grid is shown in Figure 2.

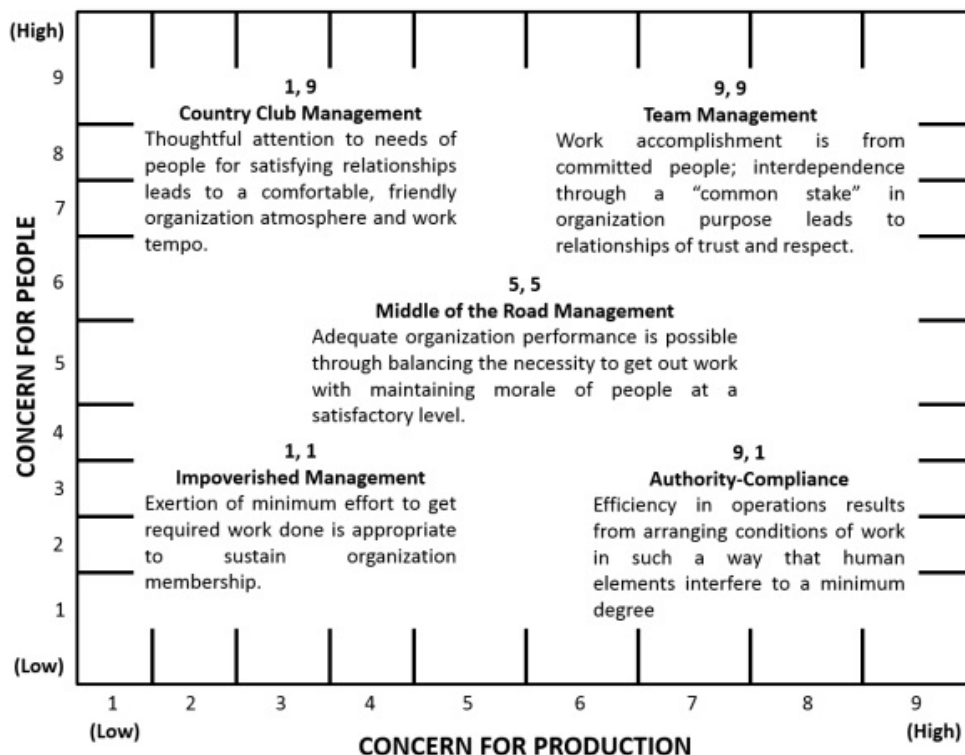

Figure 2: The Leadership Grid

Source: *The Leadership Grid figure from Leadership Dilemmas—Grid Solutions by Robert R. Blake and Anne Adams McCanse. Houston: Gulf Publishing Company, p. 29, (1991).*

Five leadership styles are briefly described as follows (Blake & Mouton, 1985):

- *Team Management* (9,9): Members work together to accomplish tasks. It's considered the best style.
- *Country Club Management* (1,9): Emphasis is given to people rather than to work outputs.
- *Authority-Compliance Management* (9,1): Efficiency in operations is the dominant orientation.
- *Middle-of-the-Road Management* (5,5): A moderate amount of concern is shown for both people and production.
- *Impoverished Management* (1,1): Leaders exert little effort.

Blake and Mouton (1985) suggested that the way to reach effective leadership is integrating task-oriented and people-oriented behaviors.

The research about the behavior approach concluded in two dominant types of leadership behaviors; people-oriented and task-oriented. The behavior types as a result of the studies are summarized in Table 3.

Table 3: Themes of Leader Behavior Research

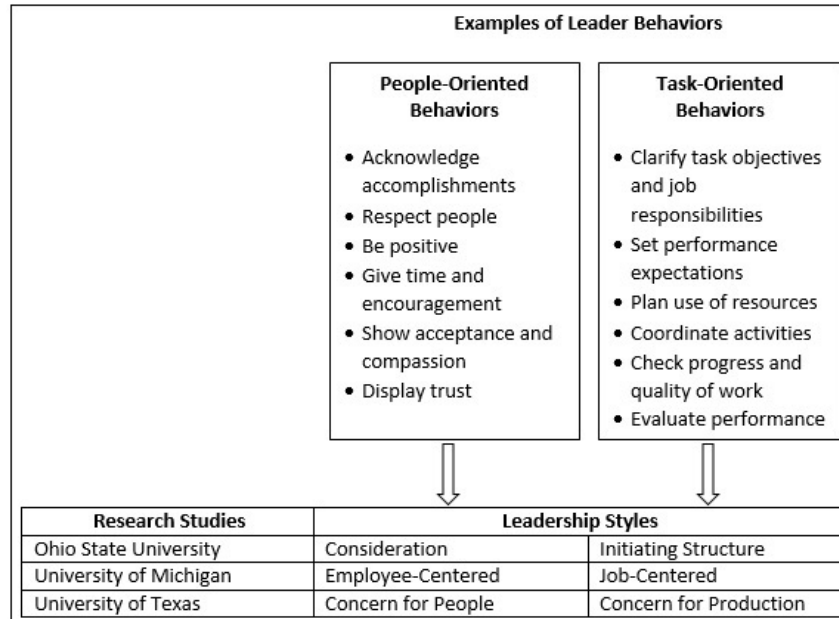

Source: *The Leadership Experience*, by Richard L. Daft, 7th Edition, Cengage Learning, (2018).

The behavior approach explored autocratic versus democratic leadership, consideration versus initiating structure, employee-centered versus job-centered leadership, and concern for people versus concern for production. These are fundamental behaviors through which leaders meet followers' needs.

3.3. Contingency (Situational) Theories

In the late 1960s, the importance of situation on the relationship between leadership style and effectiveness began to hold a great place in researches. The general assumption of the situational approach is that different situations require different leadership styles. Leaders should select a style that best fits with the situation at a given time (Gordon, 1996). This is a very practical approach because it suggests different leadership styles to different situations. Well-known theories of situational approach include: Fiedler's Contingency Model of Leadership (1967), Hersey and Blanchard's Situational Leadership Theory (1969), House's Path-Goal Theory (1971) and Vroom, Yetton, and Jago's Contingency Model (1973).

3.3.1. Fiedler's Contingency Model of Leadership

Fiedler (1967) developed the 'Contingency Model of Leadership' and defined two leadership styles: '*relationship-oriented*' and '*task-oriented*' which were again similar to consideration and initiating structure, respectively. Relationship-oriented leaders are concerned with developing good relations with their subordinates and to be liked by them. Task-oriented leaders' primary concern is to ensure that subordinates perform at a high level so the job gets done. They provide clear directions and sets performance standards.

Fiedler measures an individual's leadership style through the LPC (Least Preferred Co-worker Questionnaire). It measures the leadership style by having the leader describe a coworker with whom he/she had difficulty completing a job; not necessarily someone disliked, but someone with whom they least liked to work. After the person is chosen, the LPC instrument asks the leader to describe the coworker on a set of adjectives. The adjectives the leader chooses to describe the LPC determine if the leader is task-oriented or relationship-oriented. Examples of the adjectives used by Fiedler (1967) on the LPC scale are as follows:

- *open* *guarded*
- *quarrelsome* *harmonious*
- *efficient* *inefficient*
- *self-assured* *hesitant*

- *gloomy* *cheerful*

According to LPC scale, the leader who describes the least preferred co-worker in positive terms is relationship-oriented; and the leader who describes the least preferred co-worker in negative terms is task-oriented (Fiedler, 1967).

After assessing the leadership style through LPC, it is essential to evaluate the situation to match the leader with the situation. Leadership styles' effectiveness depends on the favorability of the situation as defined by three contingencies (Fiedler, 1967):

- *Leader-Member Relations* – quality of interpersonal relationships among a leader and group members. The extent to which followers like, trust, and are loyal to their leader
- *Task Structure* – degree of clarity or ambiguity in the group's work activities
- *Position Power* – the authority of the leader to reward and punish his/her subordinates.

A *favorable* situation will occur if leader-member relations are good, task structure is high and position power is strong; a *moderate* situation will occur if some of the three elements are high and others low; an *unfavorable* situation will occur if leader-member relations are poor, task structure is low and position power is weak (Fiedler, 1967). He suggested that, in very favorable and very unfavorable situations, the task-oriented leader would be effective, and in moderately favorable situations, the relationship-oriented leader. If the leader did not fit the situation, then the situation should have been changed by modifying these three contingencies (Den Hartog & Koopman, 2001).

3.3.2. Hersey and Blanchard's Situational Leadership Theory

Hersey and Blanchard's (1969) extension of the Leadership Grid focuses on the characteristics of followers as the most important element of the situation and, consequently, on determining effective leader behavior. There were two key leadership dimensions that Fiedler (1967) identified previously: task and relationship behaviors. In the situational leadership model, Hersey and Blanchard (1969) added the *readiness* to the task and relationship behaviors. The model explains the relationship between the followers' readiness and the effective leadership style.

The readiness level of the followers was defined as their ability and willingness to function (Hersey & Blanchard, 1969). People tend to have varying degrees of readiness, depending on the particular task or goal that a leader tries to accomplish. The model shows that the readiness levels of a leader's subordinates play a major role in determining which leadership styles are best suited. People low in readiness need a different leadership style than those who are high in readiness.

According to the situational theory, a leader can adopt one of four leadership styles, based on a combination of relationship (concern for people) and task (concern for production) behavior. The appropriate style depends on the readiness level of followers, as shown in Figure 3.

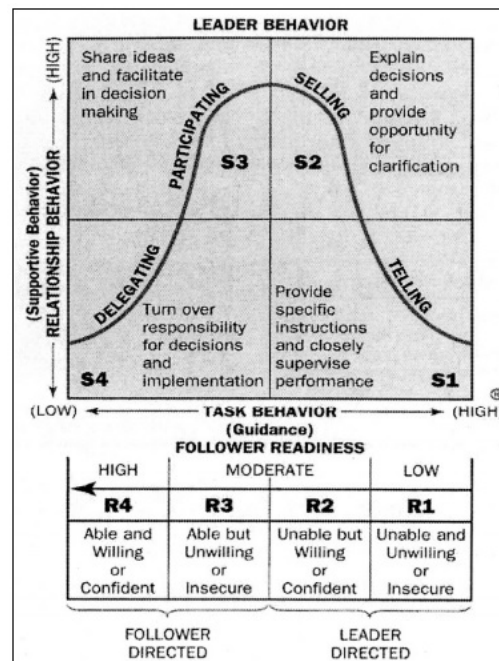

Figure 3: Hersey and Blanchard's Situational Leadership Model

Source: Hersey, P., Blanchard, K. H., (1993), *Management of Organizational Behavior – Utilizing Human Resources*, 6th Edition, Prentice-Hall International, New Jersey.

There are four stages of follower readiness (Hersey & Blanchard, 1993):

- **R1:** People are both unable and unwilling to take responsibility for doing something. They are neither competent nor confident.
- **R2:** People are unable but willing to do the necessary job tasks. They are motivated, but currently lack the appropriate skills.
- **R3:** People are able but unwilling to do what the leader wants.
- **R4:** People are both able and willing to do what is asked for them.

Task and relationship behaviors are considered as high or low and combined into four specific leadership styles (Hersey & Blanchard, 1993):

- **Telling (high task – low relationship):** The leader defines roles and tells people what, how, when, and where to do various tasks.
- **Selling (high task – high relationship):** The leader provides both directive and supportive behavior.
- **Participating (low task – high relationship):** the leader and follower share in decision-making; the main role of the leader is facilitating and communicating.
- **Delegating (low task – low relationship):** The leader provides little direction or support.

Matching the follower readiness with appropriate leader style is shown in Table 4.

Table 4: Hersey and Blanchard's Leadership Styles

Follower Readiness	Appropriate Leader Style
Low readiness level – R1	Telling (high task – low relationship)
Moderate readiness level – R2	Selling (high task – high relationship)
High readiness level – R3	Participating (low task – high relationship)
Very high readiness level – R4	Delegating (low task – low relationship)

Source: self-created in reference to Hersey, P., Blanchard, K. H., (1993), *Management of Organizational Behavior – Utilizing Human Resources*, 6th Edition, Prentice-Hall International, New Jersey

3.3.3. House's Path–Goal Theory

The most supported and influential contingency theory to date is probably House's Path-Goal Theory of Leadership, developed in 1971. The theory describes how the behavior of a leader influences the satisfaction and performance of subordinates (Yukl, 1989). According to the theory, the duty of the leader is to clean the road for the employees and get rid of problems on the way leading to defined goals, so the employees can function more efficiently (Den Hartog & Koopman, 2001). In particular, as seen in Figure 4, leaders increase follower motivation either by (House 1971):

- *clarifying the follower's path to the rewards that are available, or*
- *increasing the rewards that the follower values and desires.*

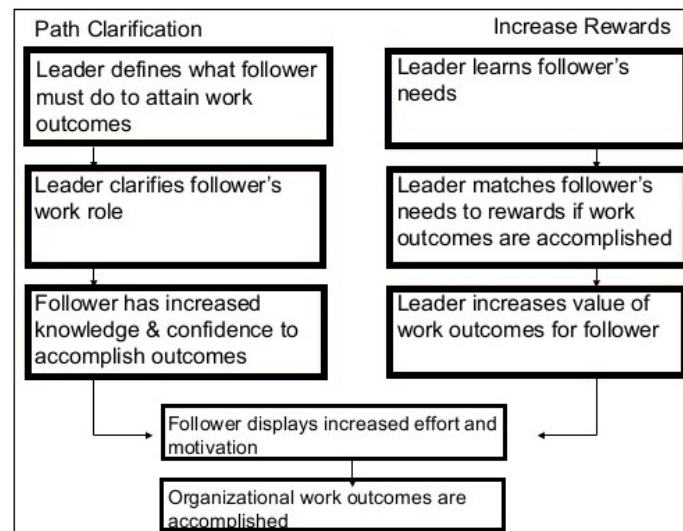

Figure 4: Leader Roles in the Path–Goal Model

Source: self-created in reference to Daft, R.L., (2018), *The Leadership Experience, 7th Edition, Cengage Learning*.

A leader may perform these behaviors by adopting a certain leadership style based on the situation. The path–goal theory suggests a fourfold classification of leadership styles (House, 1971):

- *Supportive Leadership*: leader is friendly and approachable, attends to the wellbeing of subordinates, and treats everyone as equal.
- *Directive Leadership*: leader gives instructions, expectations, timelines, and performance standards.
- *Participative Leadership*: leader invites subordinates to give ideas, share opinions and integrates their suggestions into the decision-making process.
- *Achievement-Oriented Leadership*: leader challenges subordinates to perform at the highest level possible. Leader has high standards of excellence and seeks continuous improvement.

Some examples of how leadership behavior is tailored to the situation can be seen in Figure 5.

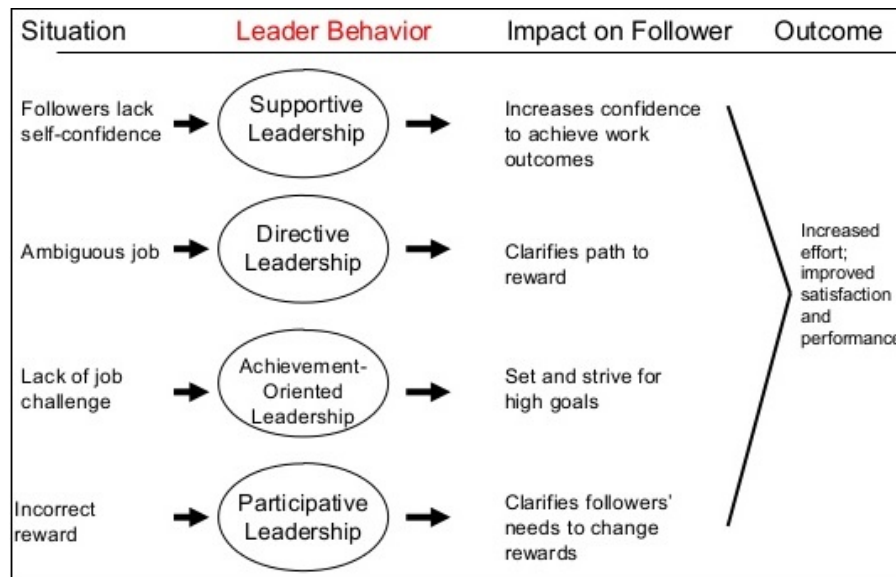

Figure 5: Path–Goal Situations and Preferred Leader Behaviors

Source: self-created in reference to Daft, R.L., (2018), *The Leadership Experience, 7th Edition, Cengage Learning*.

In all four cases, the outcome of fitting the leadership behavior to the situation produces greater employee effort by either clarifying how subordinates can receive rewards or changing the rewards to fit their needs (Daft, 2018).

3.3.4. Vroom, Yetton and Jago's Contingency Model

This model was first developed by Vroom and Yetton (1973) and some contributions were subsequently made by Vroom and Jago (1988). In the model, it is assumed that different leadership styles can be displayed by the same leader. The Vroom-Yetton-Jago Model asserts that, during the decision-making process, the contribution of the followers is important. The aim of the model is, while maintaining the quality of the decision, to provide the acceptance of it by the followers (Vroom & Jago, 1988; Vroom & Yetton, 1973). This leadership contingency model relates leadership behavior and participation in decision-making.

The model starts with the idea that a leader faces a problem that requires a solution. As a decision-making model, its premise is that the most effective leadership decision style depends on whether the leader desires a high-quality decision or is more concerned with subordinates' acceptance of the decision (Vroom & Yetton, 1973). The model's purpose is to predict when leaders should or should not allow subordinates to participate in the decision-making process. Vroom and Yetton (1973) determined five leadership styles from autocratic leadership to democratic leadership (Figure 6). A leader can choose to be autocratic and make decisions without input from employees or display democratic behaviors and encourage participation and input.

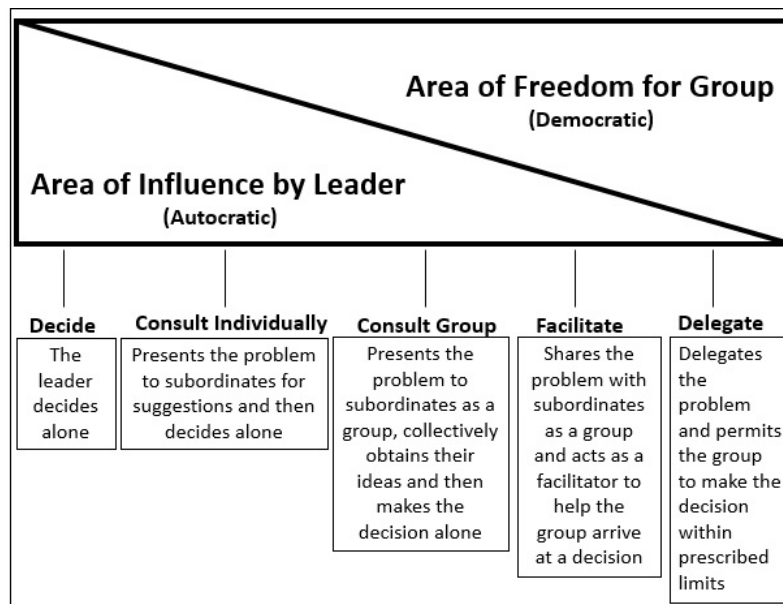

Figure 6: Vroom-Yetton-Jago Model Five Leader Decision Styles

Source: self-created in reference to Vroom, V.H. (2000), *Leadership and the decision making process. Organizational Dynamics*, 28(4), 82–94.

Vroom and Yetton's (1973) model is a normative model and it suggests a sequence of rules to be followed for determining the decision-making style. Seven diagnostic questions in the following areas can determine how much subordinates should participate in making a decision:

- *Decision Significance.* How significant is this decision for the project or organization?
- *Importance of Commitment.* How important is subordinate commitment to carrying out the decision?
- *Leader Expertise.* What is the level of the leader's expertise in relation to the problem?
- *Likelihood of Commitment.* If the leader were to make the decision alone, would subordinates have high or low commitment to the decision?
- *Goal Alignment.* Are the employee goals aligned with organizational goals?
- *Group Expertise.* What is the level of group members' knowledge and expertise in relation to the problem?
- *Team Competence.* How skilled and committed are group members to working together as a team to solve problems?

As the leader answers each question as high (H) or low (L), the answer will take the leader through the decision tree to an appropriate outcome (Figure 7).

		→								
		Decision Significance	Importance of Commitment	Leader Expertise	Likelihood of Commitment	Goal Alignment	Group Expertise	Team Competence		
P R O B L E M S T A T E M E N T	H	H	H	H	-	-	-	Decide		
				L	H	H	H	H	Facilitate	
					L	H	L	L	-	Consult (Group)
			L	H			L	-	-	Delegate
					L	H	H	H	H	Consult (Individually)
							L	-	-	Facilitate
		L	H	L	H	H	H	H	Facilitate	
						L	L	-	Consult (Group)	
					L	L	-	H	H	H
			L	L				-	Consult (Individually)	
			L	-				-	Decide	
			L	H	-	H	-	-	-	Decide
	L	-				-	H	Delegate		
	L	-		-	-	-	-	L	Facilitate	
					-	-	-	-	Decide	

Figure 7: Vroom-Yetton-Jago Model Leadership Decision Tree

Source: Vroom, V. H. (2000). *Leadership and the decision making process. Organizational Dynamics*, 28(4), 82–94.

The main assumption of the Vroom-Yetton-Jago Model is that there is no single leadership style or decision-making process that fits all situations. To find the process best suited to the situation, the leader needs to consider a number of factors. The model walks the leader through these factors logically, to help to identify the most appropriate process and style. Leaders can quickly learn to use the model to adapt their styles to fit the situation.

3.4. Contemporary Leadership Theories

Around the 1980s, the face of the business world and, in turn, the concept of effective leadership changed. Conger and Kanungo (1994) stated that: “earlier distinctions between task-oriented and people-oriented and some contingency approaches such as Fiedler’s Contingency and Path Goal Theories seemed inadequate to address certain organizational leadership issues of the 1980s.” Due to rapid globalization in the world, it became a lot harder to lead large-scale companies and be successful in change efforts. This new environment demanded different characteristics and skills from so-called effective leaders. This need in the business world emerged ‘contemporary leadership theories’ around the 1980s. Researchers defined new leadership styles and models which would not have been replaced nor explained by any other models, such as the people-oriented and task-oriented leadership models (Bass, 1990). These new leadership styles are Charismatic Leadership, Transformational Leadership, Transactional Leadership and Servant Leadership.

3.4.1. Charismatic Leadership

The charismatic leadership approach today could be considered as the most influential approach on leadership studies (Winkler, 2010). Today's theories of charismatic leadership are strongly influenced by the ideas of an early sociologist, Max Weber. He used the term to define a form of influence-based not on traditional or formal authority, but rather on follower perceptions that the leader is endowed with exceptional powers or qualities (Weber, 1947). According to Weber, charisma takes place during a social crisis, when a leader emerges with a radical vision that proffers a solution to the crisis and attracts followers who believe in the vision (Yukl, 2010). Modern development of charismatic leadership theory is often attributed to the work of Robert House (Luthans, 2010). According to House's charismatic leadership theory, followers attribute heroic or extraordinary leadership abilities when they observe certain behaviors (Conger & Kanungo, 1988; Robbins & Judge, 2013).

Several studies have tried to identify the characteristics of charismatic leaders: they have a vision, they are willing to take personal risks to achieve that vision, they are sensitive to follower needs, and they present marvelous behaviors (Conger & Kanungo, 1998; Robbins & Judge, 2013). Most experts believe that individuals are not only born with traits that make them charismatic, but also they can be trained to present charismatic behaviors (Robbins & Judge, 2013). Evidence suggests that charismatic leaders influence their followers in a four-step process. It begins with articulating an appealing vision, a long-term strategy for attaining a goal by linking the present with a better future for the organization. Second, charismatic leaders may use vision statements to imprint on followers an overarching goal and purpose. They build followers' self-esteem and confidence with high performance expectations and belief that followers can attain them. Third, through words and actions, the leader transmits a new set of values and sets an example for followers to imitate. Finally, the charismatic leader engages in emotion-inducing and often unconventional behavior to demonstrate courage and conviction about the vision. Followers catch the emotions their leader is conveying (Robbins & Judge, 2013; Shamir, House, & Arthur, 1993).

Charisma can be used for positive outcomes that benefit the group, and charismatic leaders can be portrayed as wonderful heroes. However, there can also be unethical characteristics associated with charismatic leaders. It can also be used for self-serving purposes that lead to deception, manipulation and exploitation of others (Daft & Marcic, 2009; Luthans, 2010).

3.4.2. Transformational Leadership

Transformational leadership represents a paradigm shift with regard to the study of leadership (Medley & Larochelle, 1995). As an emerging leadership paradigm, transformational leadership focuses on transformation of the organization and its members from the current state to a better state that is aligned with organizational vision, mission and goals (Top, Akdere, & Tarcan, 2015). The term transformational leadership was first introduced by Burns (1978). According to him, transformational leaders provide change and movement in an organization. They emphasize new possibilities and promote a compelling vision of the future to minimize resistance to change. Transformational leaders manifest passionate inspiration, and visibly model appropriate behaviors (Burns, 1978). Transformational leaders are briefly referred to as change agents (Eisenbach, Watson, & Pillai, 1999).

Following Burns' theory of leadership, Bass (1985) described a more detailed theory for transformational leadership. According to Bass (1985), transformational leaders make the followers more aware of the importance and values of task outcomes, activate their higher order needs, and stimulate followers to act for the sake of the organization. Bass (1985) noted that transformational leaders broaden and elevate the interests of their constituencies, and that they do so by generating awareness and acceptance of the purposes and mission of the group. Bass (1985) defined transformational leaders by their charismatic appeal to their followers, the inspiration they provide them and the individual consideration they give them. Transformational leadership also involves motivating the followers to perform beyond the minimum level of requirements for the organization by putting higher level goals and developing an appropriate work environment (Rafferty & Griffin, 2004; Williams et al., 1999). In the light of findings throughout the years, some characteristics of transformational leaders can be summarized as in Table 5.

Table 5: Characteristics of Transformational Leaders

Researchers	Characteristics of Transformational Leaders
Burns, (1978)	<ul style="list-style-type: none"> They provide change and movement in an organization.
Bass, (1985)	<ul style="list-style-type: none"> They broaden and elevate the interests of their constituencies.
Kuhnert and Lewis, (1987)	<ul style="list-style-type: none"> They are capable of having profound and extraordinary effects on people by causing shifts in the beliefs, the needs, and the values of followers; thus followers can become leaders themselves.
Den Hartog et al., (1997)	<ul style="list-style-type: none"> They transform the organization by defining the need for change, creating new visions, mobilizing commitment to these visions and by providing awareness of the organizational vision and goals.
Eisenbach et al., (1999)	<ul style="list-style-type: none"> They are referred to as change agents.
Egri and Herman, (2000)	<ul style="list-style-type: none"> They tend to direct specific activities as much as to alter moods, to evoke symbolic images and expectations, and to inspire desires and objectives.
Antonakis et al., (2003)	<ul style="list-style-type: none"> They are proactive, raise follower awareness for transcendent collective interests and motivate followers to achieve out of range goals.
Avolio and Bass, (2004)	<ul style="list-style-type: none"> They inspire followers to go beyond their own self-interests for the good of the organization with their vision. They heighten the awareness of followers with vision they create and the strategies for reaching them. They develop higher level needs for followers such as achievement, autonomy, and affiliation, which can be both work and not work related.

Source: Self-created

Transformational leaders consider their employees' individual differences and mentor them to develop themselves. Such leaders stimulate their incumbents intellectually, encourage and show them how to solve old problems with a new style, and put emphasis on rationality as a problem solving strategy (Bass, 1990).

The first clear distinction between transformational and transactional leadership was made by Burns (1978) in describing the leadership process as '*transformational*'. Bass refined the concept of transformational leadership and transactional leadership through numerous research studies in business organizations (Bass, 1999; Bass, Avolio, Jung, & Berson, 2003; Bass, Berson, & Riggio, 2006; Yammarino, Spangler, & Bass, 1993). The vast majority of researchers in existing leadership literature suggest that transformational leadership is one of the most influential approaches towards leadership (Avolio & Bass, 1995; Bass, 1995; Bass et al., 2003; Bass & Avolio, 1994; Bass et al., 2006; Bass & Steidlmeier, 1999; Hater, Bass, & Guion, 1988; Kouzes & Posner, 2007).

3.4.3. Transactional Leadership

Transactional leadership generally uses organizational bureaucracy, policy, power, and authority to maintain control; this style of leadership is occasionally referred to as authoritative (Bennet, 2009). Transactional leaders emphasize work standards, assignments, and task-oriented goals. In addition, transactional leaders tend to focus on task completion and employee compliance, and these leaders rely quite heavily on organizational rewards and punishments to influence employee performance (Tracey & Hinkin, 1998). They explain what is required of them and what compensation they will receive if they fulfil these requirements (Bass, 1990).

Transactional leadership focuses on ways to maintain the status quo and manage the day-to-day operations of a business. It does not focus on identifying the organization's goals and how employees can work toward and increase their productivity in alignment with these goals, thus increasing organizational profitability (Avolio, Waldman, & Yammarino, 1991).

Followers are motivated and corrected by the leaders' transactional actions. Egri and Herman (2000) defined the main concern of transactional leaders as being that of the accomplishment of the subordinates' task performance in terms of meeting organizational goals and objectives. Leaders gain the commitment of employees through giving them contingent rewards. Therefore, Kuhnert and Lewis (1987) suggested that effective transactional leaders must regularly fulfil the expectations of their followers.

The basis of transactional leadership is a transaction or exchange process between leaders and followers. The transactional leader recognizes followers' needs and desires and then clarifies how those needs and desires will be satisfied in exchange for meeting specified objectives or performing certain duties. Thus, followers receive rewards for job performance, while leaders benefit from the completion of tasks (Vecchio, 2002). Because of these transactional relationships, some of the theories explained in the previous section can be considered as transactional theories, such as path-goal theory and initiating structure. Transactional leadership involves a commitment to '*follow the rules*'; therefore, transactional leaders maintain stability within the organization rather than promoting change (Vecchio, 2002).

There is a temporary process for transactional leadership. Once a transaction is complete, the relationship between the leader and subordinates can end or be redefined for the next transaction (Lussier & Achua, 2001). Therefore, the nature of this kind of leadership style is based on a short-term relationship between leader and follower.

Comparison between Transformational and Transactional Leadership

Burns (1978) stated that transactional leaders motivate followers to perform their jobs, while transformational leaders insist on satisfying the needs of their followers. Burns (1978) also suggested that transactional and transformational leaderships are the two opposite ends of a whole.

An important point that separates a transactional leader from a transformational leader is that a transactional leader focuses on economy. That means a transactional leader is sensitive to who will better perform which job (Rosenberg, 1996). On the other hand, transformational leadership is the ability of understanding followers' needs, desires and what motivates them and also it is the ability of satisfying followers; thus, benefiting from employees' full capacity (Bennis, 1984; Conger, 1989; Conger & Kanungo, 1987; Sashkin & Sashkin, 1990).

Judge and Piccolo's (2004) study, which is about the relationship between transformational and transactional leadership, states that it is difficult to reveal the effect of each one of the leadership style because of the high relationship between these leadership styles. In transactional leadership, leaders and followers enter the interaction to be able to satisfy their needs mutually. However, in transformational leadership, leaders and followers enter the interaction to have a more creative environment for the benefit of the entire organization (Judge & Piccolo, 2004).

According to Ross and Offerman (1997), transformational leaders try to change organizational culture, followers' norms, targets and ideals. They try to exceed the expectations of their followers. However, transactional leaders try to reach current targets.

Bass (1995) claimed that both leadership styles can be observed in a leader. In fact, he claimed that, if transformational leadership is based on transactional leadership, the effect of the latter will be higher. Parallel to this view, Bass and Steidlmeier (1999) also affirmed that transactional and transformational leaderships are interrelated and the best of leadership emerges when they are used together. Avolio and Bass (2002) empirically proved that a combination of both may be effective and may produce positive impacts on performance. On the other hand, many research results show that transformational leadership is more effective than transactional leadership (Conger & Kanungo, 1987; Kirkpatrick & Locke, 1991; Oзарalli, 2003)

3.4.4. Servant Leadership

In the second half of the 20th century, traditional, autocratic and hierarchical leadership models were beginning to yield to newer ones (Bass, 1985; Spears, 1995). Robert K. Greenleaf (1970) defined his concept of servant

leadership, which stressed the need for a new, more holistic community-based leadership model. Ethical and caring behavior is key in this type of leadership.

Greenleaf (1970) also defined the servant leadership as leadership behavior motivated by the intention to serve so that the followers become empowered, responsible, healthier, wiser, and autonomous. Graham (1991) proposed that servant leadership would emerge as humility, relational power, autonomy and moral development of followers and emulation of leaders' service orientation. Sendjaya and Sarros (2002) studied the historical evolution of servant leadership and portrayed it as a genuine sense of calling to be just and trusted stewards and to inspire in others the full potential of their abilities.

According to Greenleaf (1970), the word 'servant' implies an approach to leadership that supports the moral and ethical empowerment of others, which is an important ingredient of becoming a servant leader. The implication of Greenleaf's conceptualization of servant leadership is that "leadership without service is less substantial, more ego-driven and selfish, instead of being community centered, altruistic and empathetic" (Crippen, 2005, p.4). Servant leadership is, therefore, not a model of leadership that is self-serving, manipulative, short-sighted or power oriented, but is motivated by the underlying principles of service (Taylor, 1998). Servant leaders believe that it is their duty to see to the overall mental and spiritual wellbeing of those with whom they associate. When people receive service and guidance from others, they will, in return, serve and lead more people, to the extent that a wider number of employees, consumers, and even the whole society perceive this service (Taylor, 1998).

The notion of servant leadership has received growing attention and recognition in recent years (Sendjaya & Sarros, 2002). Various researchers have espoused servant leadership as a valid theory of organizational leadership (Russell & Stone, 2002) with great promise for theoretical and practical development.

4. Conclusion

The productivity and success of the organizations depend on the understanding of the complex and multifaceted human factor and the creation of an appropriate working environment. It is very important to create employee productivity and job satisfaction by applying effective leadership styles, as well as to achieve organizational goals and effectiveness. At this point, the knowledge of leadership theories may help to interact better with employees and to activate more effective leadership processes.

The paper has provided a comprehensive review on the literature, research and theoretical framework of leadership. The leadership approaches mentioned in this paper need to be fully understood in order to achieve individual and organizational effectiveness and efficiency. It is hoped that this work will serve as a resource for leadership researchers.

References

- Alonderiene, R., & Majauskaite, M. (2016). Leadership Style and Job Satisfaction in Higher Education Institutions. *International Journal of Educational Management*, 30(1), 140-164. <https://doi.org/10.1108/IJEM-08-2014-0106>
- Antonakis, J., Avolio, B.J., & Sivasubramaniam, N. (2003). Context and Leadership: An Examination of the Nine-Factor Full-Range Leadership Theory Using the Multifactor Leadership Questionnaire. *The Leadership Quarterly*, 14(3), 261-295. [https://doi.org/10.1016/S1048-9843\(03\)00030-4](https://doi.org/10.1016/S1048-9843(03)00030-4)
- Avolio, B.J., & Bass, B.M. (1995). Individual Consideration Viewed at Multiple Levels of Analysis: A Multi-Level Framework for Examining the Diffusion of Transformational Leadership. *The Leadership Quarterly*, 6(2), 199-218. [https://doi.org/10.1016/1048-9843\(95\)90035-7](https://doi.org/10.1016/1048-9843(95)90035-7)
- Avolio B.J., & Bass B.M. (2002). *Developing Potential Across a Full Range of Leadership, Cases on Transactional and Transformational Leadership*. Mahwah, NJ: Lawrence Erlbaum Associates. <https://doi.org/10.4324/9781410603975>
- Avolio, B.J., & Bass, B.M. (2004). *Multifactor Leadership Questionnaire, Manual and Sampler Set (3rd ed.)*. Mind Garden, Inc.

- Avolio, B.J., Waldman, D.A., & Yammarino, F.J. (1991). Leading in the 1990s: The Four I's of Transformational Leadership. *Journal of European Industrial Training*, 15(4). <https://doi.org/10.1108/03090599110143366>
- Bass B.M. (1961). Some Aspects of Attempted, Successful and Effective Leadership. *Journal of Applied Psychology*, 45, 120-122. <https://doi.org/10.1037/h0049166>
- Bass, B.M. (1985). *Performance beyond Expectations*. New York: Free Press.
- Bass, B.M. (1990). *Handbook of Leadership: A Survey of Theory and Research*. New York: Free Press.
- Bass, B.M. (1994). *Improving Organizational Effectiveness through Transformational Leadership*. Thousand Oaks: Sage.
- Bass, B.M. (1995). Theory of Transformational Leadership Redux. *The Leadership Quarterly*, 6(4), 463-478. [https://doi.org/10.1016/1048-9843\(95\)90021-7](https://doi.org/10.1016/1048-9843(95)90021-7)
- Bass, B.M. (1997). Does the Transactional-Transformational Leadership Paradigm Transcend Organizational and National Boundaries? *American Psychologist*, 52(2), 130-139. <https://doi.org/10.1037/0003-066X.52.2.130>
- Bass, B.M. (1999). Two Decades of Research and Development in Transformational Leadership. *European Journal of Work and Organizational Psychology*, 8(1), 9-32. <https://doi.org/10.1080/135943299398410>
- Bass, B.M., & Avolio, B.J. (1994). Transformational Leadership and Organizational Culture. *International Journal of Public Administration*, 17(3-4), 541-554. <https://doi.org/10.1080/01900699408524907>
- Bass, B.M, Avolio, B.J, Jung, D.I., & Berson, Y. (2003). Predicting Unit Performance by Assessing Transformational and Transactional Leadership. *Journal of Applied Psychology*, 88(2), 207-218. <https://doi.org/10.1037/0021-9010.88.2.207>
- Bass, B.M, Berson, Y., & Riggio, R.E. (2006). *Transformational Leadership* (2nd e.). Mahwah, NJ: Lawrence Erlbaum Associates Publishers. <https://doi.org/10.4324/9781410617095>
- Bass, B.M., & Steidlmeier, P. (1999). Ethics, Character, and Authentic Transformational Leadership Behavior. *The Leadership Quarterly*, 10(2), 181-217. [https://doi.org/10.1016/S1048-9843\(99\)00016-8](https://doi.org/10.1016/S1048-9843(99)00016-8)
- Bennett, T.M. (2009). A Study of The Management Leadership Style Preferred by IT Subordinates. *Journal of Organizational Culture, Communications and Conflict*, 13(2), 1-26.
- Bennis, W.G. (1959). Leadership Theory and Administrative Behavior: The Problems of Authority. *Administrative Science Quarterly*, 4, 259-301. <https://doi.org/10.2307/2390911>
- Bennis, W.G. (1984). The Four Competencies of Leadership. *Training and Development Journal*, 38(8), 14-19.
- Bernard L.L. (1927). Leadership and Propaganda. In J. Davis & H.E. Barnes (Eds.), *An Introduction to Sociology*. New York: Heath.
- Blackmar, F.W. (1911). Leadership in Reform. *American Journal of Sociology*, 16, 626-644. <https://doi.org/10.1086/211917>
- Blake, R.R., & McCause, A.A. (1991). *Leadership Dilemmas-Grid Solutions*. Gulf Professional Publishing.
- Blake, R.R., & Mouton, J.S. (1985). *The Managerial Grid III: A New Look at The Classic that has Boosted Productivity and Profits for Thousands of Corporations Worldwide*. Houston: Gulf Publishing Company, Book Division.
- Blanchard, K., Spears, L.C., & Lawrence, M., (2001). *Focus on Leadership: Servant Leadership for the 21st Century* (3rd ed.). New York: John Wiley.
- Bolden, R., Gosling, J., Marturano, A., & Dennison, P. (2003). *A Review of Leadership Theory and Competency Frameworks*. Center for Leadership Studies University of Exeter. United Kingdom
- Burns, J.M. (1978). *Leadership*. New York: Harper & Row.
- Conger, J. A., & Kanungo, R. N. (1987). Toward a Behavioral Theory of Charismatic Leadership in Organizational Settings. *Academy of Management Review*, 12(4), 637-647. <https://doi.org/10.5465/amr.1987.4306715>
- Conger, J.A., & Kanungo, R.N. (1988). Behavioral Dimensions of Charismatic Leadership. in J.A. Conger, R.N. Kanungo & Associates (Eds.), *Charismatic Leadership* (p. 79). San Francisco: Jossey-Bass.
- Conger, J.A., & Kanungo, R.N. (1994). Charismatic Leadership in Organizations: Perceived Behavioral Attributes and Their Measurement. *Journal of Organizational Behavior*, 15(5), 439-452. <https://doi.org/10.1002/job.4030150508>
- Conger, J.A., & Kanungo, R.N. (1998). *Charismatic Leadership in Organizations*. Thousand Oaks, CA: Sage.
- Conger, J.A. (1989). Leadership: The Act of Empowering Others. *Academy of Management Executive*, 3(1), 17-25. <https://doi.org/10.5465/ame.1989.4277145>
- Copeland, N. (1942). *Psychology and the Soldier*. Harrisburg: Military Service Publication.
- Crippen, C. (2005). The Democratic School: First to serve, then to lead. *Canadian Journal of Educational Administration and Policy*, (47).
- Daft, R.L., & Marcic, D. (2009). *Understanding Management* (6th ed.). Mason, USA: South Western Cengage Learning.
- Daft, R.L. (2018). *The Leadership Experience* (7th ed.). Cengage Learning.
- Den Hartog, D.N., Van Muijen, J.J., & Koopman, P.L. (1997). Transactional versus Transformational Leadership: An Analysis of the MLQ. *Journal of Occupational and Organizational Psychology*, 70(1), 19-34. <https://doi.org/10.1111/j.2044-8325.1997.tb00628.x>

- Den Hartog, D.N., & Koopman, P.L. (2001). Leadership in Organizations. *Handbook of Industrial, Work & Organizational Psychology*, 2, 166-187. <https://doi.org/10.4135/9781848608368.n10>
- Drucker P. F. (1998). *The Leader of the Future*. San Francisco: Jossey Bass.
- Egri, C.P., & Herman, S. (2000). Leadership in the North American Environmental Sector: Values, Leadership Styles, and Contexts of Environmental Leaders and Their Organizations. *Academy of Management Journal*, 43(4), 571-604. <https://doi.org/10.5465/1556356>
- Eisenbach, R., Watson, K., & Pillai, R. (1999). Transformational Leadership in the Context of Organizational Change. *Journal of Organizational Change Management*, 12(2). <https://doi.org/10.1108/09534819910263631>
- Feldman, D.C. & Arnold, H.J. (1983). *Managing Individual and Group Behavior in Organizations*. New York: McGraw Hill.
- Fiedler, F. E. (1967). *A Theory of Leadership Effectiveness*. New York: McGraw-Hill.
- Gordon, J.R. (1996). *Organizational Behavior A Diagnostic Approach*. Upper Saddle River, NJ: Prentice Hall.
- Graham, J.W. (1991). Servant-Leadership in Organizations. *Inspirational and Moral Leadership Quarterly*, 2(2), 105-119. [https://doi.org/10.1016/1048-9843\(91\)90025-W](https://doi.org/10.1016/1048-9843(91)90025-W)
- Greenleaf, R.K. (1970). *The Servant as a Leader*. Indianapolis: Greenleaf Center.
- Hampton, D.R., Summer, C.E. & Webber, R.A. (1978). *Organizational Behavior and the Practice of Management* (3rd ed.). Glenview, IL: Scott, Foreman and Company.
- Hater, J.J., Bass, B.M., & Guion, R. (1988). Superiors' Evaluations and Subordinates' Perceptions of Transformational and Transactional Leadership. *Journal of Applied Psychology*, 73(4), 695-702. <https://doi.org/10.1037/0021-9010.73.4.695>
- Heller, F.A., & Yukl, G. (1969). Participation, Managerial Decision-Making, and Situational Variables. *Organizational Behavior and Human Performance*, 4(3), 227-241. [https://doi.org/10.1016/0030-5073\(69\)90007-5](https://doi.org/10.1016/0030-5073(69)90007-5)
- Hemphill, J.K., & Coons, A.E. (1957). Development of the Leader Behavior Description Questionnaire. In R. Stogdill & A. Coons (Eds.). *Leader Behavior: Its Description and Measurement* (pp.6-38). Columbus, Ohio: Bureau of Business Research.
- Hersey, P., & Blanchard, K.H. (1969). Life Cycle Theory of Leadership. *Training & Development Journal*, 23(5), 26-34.
- Hersey, P., & Blanchard, K.H. (1993). *Management of Organizational Behavior – Utilizing Human Resources* (6th ed.). New Jersey: Prentice-Hall International.
- House, R.J. (1971). A Path-Goal Theory of Leader Effectiveness. *Administrative Science Quarterly*, 16(3), 321-339. <https://doi.org/10.2307/2391905>
- Ilies, R., Nahrgang, J.D., & Morgeson F.P. (2007). Leader–Member Exchange and Citizenship Behaviors: A Meta-Analysis. *Journal of Applied Psychology*, 92 (1), 269 –277. <https://doi.org/10.1037/0021-9010.92.1.269>
- Judge, T.A., & Piccolo, R.F. (2004). Transformational and Transactional Leadership: A Meta-Analytic Test of Their Relative Validity. *Journal of Applied Psychology*, 89(5), 755. <https://doi.org/10.1037/0021-9010.89.5.755>
- Jung, R.H. (2013). *Allgemeine Managementlehre* (6th ed.). Berlin: ESV.
- Katz, D., Kahn, R. (1966). *The Social Psychology of Organizations*. New York: Wiley.
- Kirkpatrick, S.A., & Locke, E.A. (1991). Leadership: Do Traits Matter? *Academy of Management Executive*, 5(2), 48-60. <https://doi.org/10.5465/ame.1991.4274679>
- Knickerbocker, I. (1948). Leadership: A Conception and Some Implications. *Journal of Social Issues*, 4, 23-40. <https://doi.org/10.1111/j.1540-4560.1948.tb01508.x>
- Kouzes, J.M., & Posner, B. (2007). *The Leadership Challenge* (4th ed.). San Francisco: Jossey- Bass.
- Kuhnert, K.W., & Lewis, P. (1987). Transactional and Transformational Leadership: A Constructive/Developmental Analysis. *Academy of Management Review*, 12(4), 648-657. <https://doi.org/10.5465/amr.1987.4306717>
- LePine, J.A, Erez, A., & Johnson, D.E. (2002). The Nature and Dimensionality of Organizational Citizenship Behavior: A Critical Review and Meta-Analysis. *Journal of Applied Psychology*, 87(1), 52–65. <https://doi.org/10.1037/0021-9010.87.1.52>
- Lewin, K. (1939). Field Theory and Experiment in Social Psychology: Concepts and Methods. *American Journal of Sociology*, 44(6), 868-896. <https://doi.org/10.1086/218177>
- Lord, R.G., De Vader, C.L., & Alliger, G.M. (1986). A Meta-Analysis of the Relation between Personality Traits and Leadership Perceptions: An Application of Validity Generalization Procedures. *Journal of Applied Psychology*, 71(3), 402-410. <https://doi.org/10.1037/0021-9010.71.3.402>
- Lussier, R.N., & Achua, C.F. (2001). *Leadership: Theory, Application, Skill Building*. Cincinnati: South Western College.
- Luthans, F. (2010). *Organizational Behavior an Evidence Based Approach* (12th ed.). McGraw-Hill/Irwin.
- Mann, R.D. (1959). A Review of the Relationships between Personality and Performance in Small Groups.

- Psychological Bulletin, 56(4), 241-270. <https://doi.org/10.1037/h0044587>
- Medley, F., & Larochelle, D.R. (1995). Transformational Leadership and Job Satisfaction. *Nursing Management*, 26(9), 64JJ-64NN. <https://doi.org/10.1097/00006247-199509000-00017>
- Northouse, P.G. (2004). *Leadership: Theory and Practice*. Thousand Oaks: Sage.
- Ozaralli, N. (2003). Effects of Transformational Leadership on Empowerment and Team Effectiveness. *Leadership & Organization Development Journal*, 24(6), 335-344. <https://doi.org/10.1108/01437730310494301>
- Podsakoff, P.M., MacKenzie, S.B., Moorman, R.H., & Fetter, R. (1990). Transformational Leader Behaviors and Their Effects on Followers' Trust in Leader, Satisfaction and Organizational Citizenship Behaviors. *Leadership Quarterly*, 1(2), 107-142. [https://doi.org/10.1016/1048-9843\(90\)90009-7](https://doi.org/10.1016/1048-9843(90)90009-7)
- Pondy, L.R. (1989). Leadership as a Language Game, In M.W. McCall Jr & M.M. Lombardo (Eds.), *Leadership*. Durham: Duke University Press.
- Rafferty, A.E., & Griffin, M.A. (2004). Dimensions of Transformational Leadership: Conceptual and Empirical Extensions. *The Leadership Quarterly*, 15(3), 329-354. <https://doi.org/10.1016/j.leaqua.2004.02.009>
- Robbins, S.P., & Judge, T.A. (2013). *Organizational Behavior* (15th ed.). New Jersey: Prentice Hall.
- Robbins, S.P., & Coulter, M., (2005). *Management* (8th ed.). New Jersey: Pearson Prentice Hall.
- Rosenberg, P. (1996). Comparative Leadership Styles of Male and Female Therapists. In B. DeChant (Ed.), *Women and Group Psychotherapy*, New York, NY; Guilford Press.
- Ross, M.S., & Offerman, R.L. (1997). Transformational Leaders: Measurement of Personality Attributes and Work Performance. *Personality & Social Psychology Bulletin*, 23 (10), 1078-1086. <https://doi.org/10.1177/01461672972310008>
- Russell, R.F., & Stone, A.G. (2002). A Review of Servant Leadership Attributes: Developing a Practical Model. *Leadership & Organization Development Journal*, 23(3), 145-157. <https://doi.org/10.1108/01437730210424>
- Sashkin, S., & Sashkin, M.G. (1990). Leadership and Culture Building in Schools: Quantitative and Qualitative Understanding. Paper Presented at a meeting of the American Educational Research Association, Boston.
- Schein, E.H. (1992). *Organizational Culture and Leadership*. San Francisco: Jossey Bass.
- Sendjaya, S., & Sarros, J.C. (2002). Servant Leadership: Its Origin, Development, and Application in Organizations. *Journal of Leadership and Organizational Studies*, 9(2), 57-65. <https://doi.org/10.1177/107179190200900205>
- Shamir, B., House, R.J., & Arthur, M.B. (1993). The Motivational Effects of Charismatic Leadership: A Self-Concept Theory. *Organization Science*, 4(4), 577-594. <https://doi.org/10.1287/orsc.4.4.577>
- Shaw, J., & Newton, J. (2014). Teacher Retention and Satisfaction with a Servant Leader as Principal. *Education*, 135(1), 101-106.
- Siddique, A., Aslam, H.D., Khan, M., & Fatima, U. (2011). Impact of Academic Leadership on Faculty's Motivation and Organizational Effectiveness in Higher Education System. *International Journal of Academic Research*, 3(3), 730-737.
- Spears, L. (1995). *Reflections on Leadership*. New York: John Wiley & Sons, Inc.
- Stogdill, R.M. (1948). Personal Factors Associated with Leadership: A Survey of the Literature. *Journal of Psychology*, 25, 35-71. <https://doi.org/10.1080/00223980.1948.9917362>
- Stogdill, R.M. (1950). Leadership, Membership and Organization. *Psychological Bulletin*, 47(1), 1-14. <https://doi.org/10.1037/h0053857>
- Stogdill, R.M. (1974). *Handbook of Leadership: A Survey of the Literature*. New York: Free Press.
- Tannenbaum R.J. (1961). *Leadership and Organizations, a Behavioral Science Approach*. New York: McGraw Hill.
- Tannenbaum, R., & Schmidt, W.H. (1973). How to Choose a Leadership Pattern. *Harvard Business Review* (May).
- Taylor-Gillham, D.J. (1998). *Images of Servant Leadership in Education*. Unpublished Dissertation, Northern Arizona University, Flagstaff, AZ.
- Top, M., Akdere, M., & Tarcan, M. (2015). Examining Transformational Leadership, Job Satisfaction, Organizational Commitment and Organizational Trust in Turkish Hospitals: Public Servants versus Private Sector Employees. *The International Journal of Human Resource Management*, 26(9), 1259-1282. <https://doi.org/10.1080/09585192.2014.939987>
- Tracey, J., & Hinkin, T. (1998). Transformational Leadership or Effective Managerial Practices? *Group & Organization Management*, 23(3), 220-236. <https://doi.org/10.1177/1059601198233002>
- Vecchio, R.P. (2002). Leadership and Gender Advantage. *The Leadership Quarterly*, 13(6), 643-671. [https://doi.org/10.1016/S1048-9843\(02\)00156-X](https://doi.org/10.1016/S1048-9843(02)00156-X)
- Vroom, V.H., & Yetton, P.W. (1973). *Leadership and Decision-Making*. Pittsburg: University of Pittsburg Press. <https://doi.org/10.2307/j.ctt6wrc8r>
- Vroom, V.H., & Jago, A.G. (1988). *The New Leadership: Managing Participation in Organizations*. Englewood Cliffs, NJ: Prentice Hall.
- Vroom, V.H., & Jago, A.G. (2007). The Role of the Situation in Leadership, *American Psychologist*, 62(1), 17-

24. <https://doi.org/10.1037/0003-066X.62.1.17>
- Vroom, V.H. (2000). Leadership and the Decision-Making Process. *Organizational Dynamics*, 28(4), 82–94. [https://doi.org/10.1016/S0090-2616\(00\)00003-6](https://doi.org/10.1016/S0090-2616(00)00003-6)
- Weber, M. (1947). *The Theory of Social and Economic Organization*. (A.M. Henderson & T. Parsons, Trans.). New York: Oxford University Press.
- Williams, E.S., Pillai, R., & Schriesheim, C.A. (1999). Fairness Perceptions and Trust as Mediators for Transformational and Transactional Leadership: A Two Sample Study. *Journal of Management*, 25 (6), 897-933. <https://doi.org/10.1177/014920639902500606>
- Winkler, I. (2010). *Contemporary Leadership Theories: Enhancing the Understanding of the Complexity, Subjectivity and Dynamic of Leadership*. Denmark: Physica-Verlag.
- Yammarino, F.J., Spangler, W.D., & Bass, B.M. (1993). Transformational Leadership and Performance: A Longitudinal Investigation. *The Leadership Quarterly*, 4(1), 81-102. [https://doi.org/10.1016/1048-9843\(93\)90005-E](https://doi.org/10.1016/1048-9843(93)90005-E)
- Yang, Y.F. (2014). Studies of Transformational Leadership: Evaluating Two Alternative Models of Trust and Satisfaction. *Psychological Reports*, 114(3), 740-757. <https://doi.org/10.2466/01.04.PR0.114k27w2>
- Yang, Y.F., & Islam, M. (2012). The Influence of Transformational Leadership on Job Satisfaction: The Balanced Scorecard Perspective. *Journal of Accounting & Organizational Change*, 8(3), 386-402. <https://doi.org/10.1108/18325911211258353>
- Yukl, G. (1989). Managerial Leadership: A Review of Theory and Research. *Journal of Management*, 15(2), 251-289. <https://doi.org/10.1177/014920638901500207>
- Yukl, G. (2010). *Leadership in Organizations* (7th ed.). New Jersey: Pearson Education
- Zaccaro, S.J., & Klimoski, R. (2001). *The Nature of Organizational Leadership*. San Francisco: Wiley



Determinants of Board Independence in the Banking Sector of Bangladesh

Md. Rezaul Karim¹, Dr. Ranjan Kumar Mitra, FCMA², Ibrahim Khan³

¹ Assistant Professor in the Department of Accounting & Information Systems, University of Dhaka, Dhaka, Bangladesh. Email: reza.aais@du.ac.bd

² Associate Professor in the Department of Accounting & Information Systems, University of Dhaka, Dhaka, Bangladesh. Email: ranjan.aais@du.ac.bd or ranjandu@yahoo.com

³ MBA Graduate in the Department of Accounting & Information Systems, University of Dhaka, Dhaka, Bangladesh.

Abstract

This paper examines the determinants of board independence in the banking sector of Bangladesh. The study applies a multivariate panel regression analysis for the thirty banks listed with DSE covering the period from 2006 to 2016. We use the proportion of independent directors to total number of directors on the board to measure board independence. Findings of the empirical analysis show that a board is likely to be more independent when independent directors have relevant skill and knowledge as required by prevailing corporate governance regulation. Besides, this paper finds that the boards of larger firms are more independent than those of smaller firms. Moreover, the boards of the levered firms tend to be more independent because debt holders exert intense pressure to implement stringent monitoring mechanisms. Another vital finding of this paper is that board independence is lower for older firms. A plausible reason might be that matured firms devise stricter and more efficient internal control mechanisms that offset the need for independent board. This study also reports findings that are contrary to the traditional belief. For example, we find that longer tenure and prior relationship of independent directors with the firm increases board independence by developing a sense of dedicative attachment of the independent directors with the firm. On the other hand, larger and active boards tend to be an impediment for board independence. Finally, we find no association of board independence with growth opportunity, profitability, and board gender diversity. The findings will have policy implications in designing the role of board independence.

Keywords: Board Independence, Corporate Governance, Banking Sector, Bangladesh

JEL Classification: G3, G34, O5

1. Introduction

The collapse of some highly renowned, globally appreciated, and apparently successful corporate giants (i.e. Enron, WorldCom, Tyco International, Olympus etc.) on the onset of the 21st century has caused a major crack in the investors' faith on the governance of firms. This has in turn led to a rethinking by the regulators of the effectiveness of the existing corporate governance mechanisms. In order to regain investors' confidence, regulators, professional bodies, and government agencies have introduced a broad range of laws and codes with

the goal of strengthening the effectiveness of corporate governance mechanisms in both listed and non-listed firms. In line with such a movement, the incorporation of the concept of Independent Directors (ID) in the board to safeguard the broader interest of the stakeholders works as an important tool to ensure sound corporate governance in firms. Thus, regulators and other stakeholders have, from time to time, expressed their concerns regarding the independence and expertise of the independent directors serving in the board.

Independent directors have become a vital instrument in representing the interests of all stakeholders ranging from the tax authority to the minority shareholders. In fact, it is often said that independent directors are the first line of defense for minority shareholders (Juan Ma and Tarun Khanna, 2013). Moreover, being in a position to act without the undue influence of the management, independent directors provide third-party advice and oversight in ensuring the proper governance of the firms. It has been found that shareholders react favorably to the appointment of outside directors (Rosenstein and Wyatt, 1990). Consistent with this, by studying the stock market reaction to the sudden death of an outside director, Nguyen and Nielsen (2010) found that shareholders react negatively to the loss of outside directors. Although the impact of the presence of independent directors on performance is less clear, Knyazeva, Knyazeva, and Masulis (2013) found that independent directors are positively associated with firm value (market to book ratio) and operating performance (ROA). Again, Duchin, Matsusaka, and Ozbas (2010) observed that if the cost of acquiring information is low, performance increases when outside directors are added to the board (Tobin's Q and ROA). In addition, independent directors work as agents of negotiating conflicts of interests between management and the board due to their independence from both. Besides mitigating conflict, independent directors have other advantages as well. They supposedly have more general knowledge compared with an executive director who has more firm-specific knowledge. Thus, the independent directors very often possess a clear view of the environment external to the business and this enables him to identify and focus on various external issues bearing significance to the firm in the long run. This way, independent directors are capable of standing back from each issue and contemplating them in light of their expertise without bias.

The effectiveness of independent directors is limited by the extent to which they are truly independent. Historically not all independent directors have been truly independent. Hwang and Kim (2009) tested whether NYSE accurately measures independence and found that 87% are NYSE independent, but only 62% are both NYSE and socially independent. Independent directors need true independence from the board and management in order to ensure a harmless tie between the controlling and minority interest, sound governance and promote a culture of transparency as well as accountability. In Times of Malta, Christmas (2014) accurately emphasizes the independence of an independent director from managers and other service providers meaning the independent director and his close relatives must not be the employees or even owners of the service providers. He mentions that the reason of such a drive towards independence is the avoidance of conflicts of interests. Christmas (2014) adds that the reason behind an independent director's ability to add value to the firm is his capability to raise questions and criticize the top management executives should any conflict arises and therefore an independent director is effective only if he has such strength and character that enable him to do so. This implies that independence is the underlying factor that makes independent directors an effective tool to better governance.

All these evidences provide a strong ground to assess the factors affecting the board independence in Bangladesh. In doing so, we choose the banking sector as the area of our study because this is a vastly important sector having massive impact on the economy of Bangladesh. Moreover, the banks in Bangladesh are subject to tight regulatory control because of its involvement with broader public interest. However, this sector is currently facing severe liquidity crisis due to escalating amount of non-performing loan and resulting bad debt. This crisis is often attributed to the lack of good corporate governance practiced by the board. Allegations are that the board itself has overridden internal credit approval process to sanction loan to politically powerful but likely to default loan applicant. The present dismal state of corporate governance in the banking sector underpins the significance of a strong independent board which can serve as a deterrent to the sponsors' family influence on the board. Despite such potential, no extensive research has been conducted to date to investigate board independence in this highly critical sector. The demand for board independence generally originates from regulators, management, shareholders, and creditors of a firm. The limited work concerning board independence in Bangladesh motivates our study and strengthens the empirical significance of the determinants of board independence to different

stakeholders among which the primary are shareholders, managers and regulatory authorities such as Bangladesh Bank or Bangladesh Securities and Exchange Commission.

In this paper, we investigate the determinants of board independence in the banking sector of Bangladesh by using multivariate regression analysis for 30 scheduled banks that provide the required information for the period 2006 to 2016. We exclude specialized banks in this analysis. The main objective of this study is to find out the relevant factors that influence board independence in the banking sector of Bangladesh. The results we report are expected to greatly benefit the shareholders, and regulators. Shareholders can apply the outcome of this paper in deciding what factors to consider before approving the appointment of an independent director in the AGM while regulators can use the findings to assess the effectiveness of existing regulation relating to the improvement of governance through appointing independent directors.

We organize the rest of this paper as follows: section two provides a brief review of prior studies on independent directors which are very inadequate till date. Section three presents the overview of independent directors, their role and relevant attributes. The development of hypotheses and rationale for their development are discussed in section four. Section five deals with various aspects of research design issues. The results of this study are presented, analyzed and discussed in section six and finally, section seven concludes the paper with some suggestions for future research opportunities.

2. Literature Review

There is a huge research gap till date concerning the empirical testing of the determinants of board independence in both local and international arena. The inadequacy of prior works in this field can be attributed to the difficulty of constructing a model that truly captures such a subjective concept as independence. Yet, the same inadequacy inspires me to take this as my topic of study. In this section we provide a succinct summary of prior studies that investigate the independence of the board.

There is a vast literature to improve the corporate governance of firms done by both academics and practitioners. Many such studies have either directly suggested or indirectly inferred that board independence or the existence of independent directors are associated with higher quality of governance while others have mixed findings often suggesting that board independence is neither a necessary nor a sufficient condition for strengthening firm governance practices. Weisbach (1988) found that in case of poor performance, a board dominated by outside independent directors is more likely to fire the top management. Moreover, Brickley, Coles, and Terry (1994) found evidence in favor of their hypothesis that outside directors are more likely to vote in the interests of the shareholders when the firm considers adopting poison pill strategy to avoid unfavorable acquisition. Byrd and Hickman (1992) showed that, a board dominated by outside directors realized much higher abnormal returns during announcement periods of tender offers. Besides, Rosenstein and Wyatt (1990) tested the effect of an event altering a specific governance mechanism. They found that the market reacted quite favorably to the inclusion and addition of outside directors to the board. Again, Gupta and Lee (2004) showed that payments for director premium and officer liability insurance are smaller in firms that have better governance. A general conclusion that follows from the results of these studies is that a board dominated by outside directors mitigate agency costs in various ways. However, two issues need to be mentioned here. First, there is a difference between outside directors and independent directors even though the two terms are often used interchangeably. An independent director is an outside director without any material interests in the business of the firm. This is where the question of determining true independence of independent directors comes. As D Clarke (2006) clearly puts that the concept of non-management directors (NMDs) originate with the objective of assisting stockholders in solving agency problems and if NMDs are to effectively overlook management, they must be independent of the management. Second, contrary findings that no statistically significant relationship exists between the independence of board and firm performance are also in vogue. For example, Bhagat and Black (2001) didn't find any significant relationship between firm performance and independent directors' presence in the board.

Actually, there are two conflicting schools of thoughts regarding the effect of board composition on firm performance-agency theory and stewardship theory (Dalton et.al., 1998; Ramdani and Witteloostuijn, 2010). These

theories provide contradictory predictions about independence of board and firm performance. The approach of agency theory can be used to predict that proportion of independent directors in the board is positively associated with firm performance as a way to mitigate agency costs. On the other hand, stewardship theory hypothetically predicts the same variables to be negatively associated as it assumes that executive directors are more informed about the current and future prospects of the firm than do independent directors and have a greater role to play in the operations of the firm. The findings of various researches regarding the representation of independent directors on the board and firm performance are, therefore, mixed. There are a good number of studies that have empirically examined the relationship between board independence (proportion of IDs in the board of a firm) and firm performance measures such as return on assets (ROA) or return on equity (ROE) and discovered a positive relationship (Hutchinson and Gul, 2002; Bonn, 2004). Knyazeva, Knyazeva, and Masulis (2013) also examined the relation between independent directors and firm performance using a sample of 900 small and mid-sized firms in S&P 1500 index for the period 1996 to 2006. They reported that independent directors positively affect both profitability and operating performance of the firms. On the contrary, others couldn't confirm a robust conclusion about any such statistically significant relationships (Christensen et.al., 2010; Azim, 2012). Some studies have tested the relationship between independence of the board and market-to-book ratios and have been able to display some convincing evidence of a positive and statistically significant relationship (Henry, 2008) while some others have provided a negative and statistically significant relationship (Kiel and Nicholson, 2003). Meanwhile, some researchers cannot confirm that any statistically significant relationship exists between board independence and firm performance (Azim, 2012; Matolcsy et.al., 2004; Bonn, 2004; Pham, Suchard and Zein, 2013; Christensen et.al., 2010). While the balancing evidence suggests that board independence or in other terms, the higher extent of presence of independent directors on the board, improves firm performance, the findings of these studies are obviously mixed.

While it comes about the perceptions of shareholders about independent directors, a large number of studies present findings that favor the independent directors. Examining 1,251 outside directors announcements for the period 1981 to 1985, Rosenstein and Wyatt (1990) found statistically significant positive reaction of stock price in the two-day trading windows around the announcements. They concluded that shareholders had favorable reaction towards the appointment of independent directors and the results were strongest for the small firms. Another study with somewhat similar conclusion put in a different way was undertaken by Nguyen and Nielsen (2010) who examined how the stock market reacts to the sudden death of an independent director. They took into consideration a sample of 229 deaths from 1994 to 2007 and reported that shareholder tend to react negatively to unanticipated loss of an independent director. They also found that the negative reaction was more intense when the directors served key roles such as the chair of the board or head of audit committee or when the representation of independent directors on the board was low and the reaction was comparatively less negative when the directors had already served for longer period in the board. Another striking role played by outside independent directors in enhancing firm value, as reported by Cotter, Shivdasani, and Zenner (1997), is their ability to negotiate higher takeover premiums. That is, independent directors play a role which is both statistically and economically significant in enhancing firm value during tender offers. Moreover, Byrd and Hickman (1992) report empirical findings that support the hypothesis that a more rational merger activity is encouraged by independent directors. However, both Boyd (1994) and Finkelstein and Hambrick (1989) have documented evidence that independent directors don't lead to tighter or lower CEO compensation.

After critically examining the pros and cons of independent directors, an important question to ask is how important it is to determine whether independent directors are truly independent. Realizing the importance of independent directors being free from any managerial influence, D Clarke (2006) nicely puts that directors expected to perform their designated functions cannot actually do so as long as they are not systematically independent of management. As mentioned before, Christian (2018) puts in Times of Malta that it should be definite that an independent director be free not only from managers and executives but also from the service providers, that is he and his close relatives should not have any sort of tie with the employees or even the shareholders of the firm so as to avoid conflict of interests. Recognizing the importance of true independence of independent director, it is worthwhile to have a check on the factors that drive the extent of board independence.

To date, both in local and global arena, there has not been much extensive empirical research about the factors that directly or indirectly determine or even influence the level of board independence. Therefore, the study is motivated to address the research gap regarding the empirical testing of the determinants of board independence in the context of the banking sector of Bangladesh.

3. An Overview of Independent Directors

3.1 Definition of independent director

An independent director is a non-executive member of the board of directors of an incorporated company, who, apart from receiving director's remuneration, does not have any material interest in the company whether pecuniary or not. According to D Clarke (2006), an independent director is *“one who has no need or inclination to stay in the good graces of management, and who will be able to speak out, inside and outside the boardroom, in the face of management's misdeeds in order to protect the interests of shareholders.”*

The definition of independent director is entangled by the term “independent” as it is subject to interpretation rather than any objectively determinable criteria. Still as agreed by most regulators and academics, the term independent here means the absence of any pecuniary or material relationship with the firm in consideration and its insiders such as management and sponsor directors. The concept of independent director thus evolves to deal primarily with the agency problem. As a result, it is expected that independent director should not have any material relationship with firms' insiders whether financial or not that impedes them from undertaking the role they are supposed to play in the board- mitigating agency problems. But the presence of approved *sitting charge* or *fees* doesn't necessarily preclude the independence of independent directors. Thus in India, clause 49 of the listing agreements defined independent directors as *“directors who apart from receiving director's remuneration, do not have any other material pecuniary relationship or transactions with the company, its promoters, its management or its subsidiaries, which in judgment of the board may affect independence of judgment of the directors”*. Similarly emphasizing the importance of independence of independent directors, NYSE states that *“no director qualifies as 'independent' unless the board of directors affirmatively determines that the director has 'no material relationship' with the listed company, either directly or indirectly as a partner, shareholder or officer of an organization that has a relationship with the company.”* In line with the definitions above, regulators in Bangladesh also refer to independent directors as directors who are ‘independent of material monetary and other relationships from management, sponsors, sponsor directors, and controlling shareholders’.

Another important part of the definition of independent directors concerns their expertise. An independent director must possess relevant business acumen so as to enable him to act as a bridge between the management and different stakeholders of the firm ranging from minority shareholders to regulators. In fact, most legislation explicitly mentions that an independent director must be a person of high integrity and sound business knowledge. Moreover, some countries have vested the role of independent directors to a specific class of professionals such as business leaders, law, economics, finance, and accounting professionals and academics of the same areas of expertise, government officials serving higher ranks etc. Closely related with knowledge is the experience of independent directors and it has also been remarked as a distinguishing quality of them. Thus, taken together independent directors must combine integrity, independence, and relevant business knowledge along with experience.

3.2 Independent directors in Bangladesh: A regulatory framework

Although the origin of the concept of independent directors can be traced back to the 1950s even before legislation mandated it, this concept of independent director in Bangladesh is only about a decade old. For the first time, Bangladesh Securities and Exchange Commission (BSEC) introduced the concept of independent director in the country through their corporate governance guideline dated February 20, 2006 (SEC Notification No. SEC/CMRRCD/2006-158/Admin/02-08) which was subsequently amended on August 07, 2012 (SEC NOTIFICATION No. SEC/CMRRCD/2006-158/134/Admin/44). The latter issue of the notification improves the former in several ways. The following table compares the two issues of the CG guidelines regarding provisions related to independent directors.

Table I: Comparative analysis between SEC Notification 2006 and SEC Notification 2012 regarding Independent Directors

Issue	Notification 2006	Notification 2012
Definition of ID	<p>1. It was not clearly mentioned what will be meant by Family relationship and who constituted family relationships.</p> <p>2. Partners or executives of the concerned company's statutory audit firm had not been considered disqualified to be the ID of the company.</p> <p>3. Being a defaulter was not mentioned to be a reason of disqualification for the post of an ID.</p>	<p>1. It has been clearly mentioned that spouse, son, daughter, father, mother, brother, sister, son-in-law, and daughter-in-law shall be considered as family members.</p> <p>2. A current partner or an executive or one who had been the partner or an executive during the preceding 3 (three) years of the concerned company's statutory audit firm is disqualified to be the ID of the company.</p> <p>3. One being convicted by a court of competent jurisdiction as a defaulter in payment of any loan to a bank or a Non-Bank Financial Institution (NBFI) is disqualified for the post of an ID.</p>
Tenure	Nothing was mentioned about the tenure of an ID.	The tenure of office of an independent director shall be for a period of 3 (three) years, which may be extended for 1 (one) term only.
Minimum Number of ID in the Board	At least one tenth (1/10) of the total number of the company's board of directors, subject to a minimum of one shall be independent directors.	At least one fifth (1/5) of the total number of directors in the company's board shall be independent directors.
Appointment of ID	The independent director(s) should be appointed by the elected directors.	The independent director(s) shall be appointed by the board of directors and approved by the shareholders in the Annual General Meeting (AGM).
Vacancy of the post of the ID	Nothing was mentioned about the maximum days for which the post of an ID can remain vacant.	The post of independent director(s) cannot remain vacant for more than 90 (ninety) days.
Maximum number of companies an ID can serve	Nothing was mentioned about the maximum number of companies an ID can serve.	One shall not be an independent director in more than 3 (three) listed companies.
Qualifications of ID	Nothing about the qualifications of IDs was mentioned.	<p>An ID-</p> <ul style="list-style-type: none"> • Shall be a knowledgeable individual with integrity • Is able to ensure compliance with financial, regulatory and corporate laws • Can make meaningful contribution to business • should be a Business Leader/ Corporate Leader/ Bureaucrat/ University Teacher with Economics or Business Studies or Law background/ Professionals like Chartered Accountants, Cost & Management Accountants, Chartered Secretaries • must have at least 12 (twelve) years of corporate

		management/professional experiences
Chairman of the audit committee	May or may not be an ID.	Must be an ID.

By analyzing the two versions of CG guidelines, it has been found that the latest issue of 2012 takes the matter of independent directors as a mechanism of ensuring sound corporate governance quite seriously unlike the past one and has a stronger emphasis on the role and qualifications of independent directors. Yet, it is not all conclusive as it leaves some confusion such as-

- Whether the size of the board is inclusive or exclusive of the IDs while calculating the minimum number of IDs in the board.
- Moreover it has not specified the perquisites and other financial benefits an ID might expect from the company he serves.
- It has not mentioned what is the extent of benefits received by the ID that will not pose a threat to his independence and objectivity.
- The extent to which an ID will be liable if he fails to discharge his responsibilities properly.
- Who are the primary stakeholders (i.e. Shareholders or public interest) the IDs should strive to secure should a conflict of interest occurs etc.

Taken together, it can be said that despite meaningful contribution till date, the introduction of IDs as a solution to corporate governance problems needs to be improved in order to make it viable and BSEC has a significant role to play in this regard.

4. Hypotheses Development

Agency theory implies that information asymmetry would exist in a situation where the ownership of a business is separate from its management. Moral hazard and adverse selection are two major problems that might arise because of such a separation of management from ownership. In such a situation, one would anticipate a conflict of interests between the principals (owners) and agents (management) and the resulting loss is the agency costs. Independent directors can be a useful instrument in mitigating such agency costs by acting as a watchdog in the board with a view to balancing the conflicting interests of the competing groups such as owners and management. But, as one would easily predict, their role will be effective only if they, themselves, are not caught up by any material interests in the business under consideration. Here is where the significance of independent directors' true independence comes into action. Only a truly independent director can add value to the organization as long as it is a matter of displaying a balance of conflicting interests by reducing information asymmetry.

In this section, we develop a set of testable hypotheses for each tentative variable that is likely to have an influence on the independence of the board. We identified some variables from extant literature and suggested some new variables based on our analysis of prior theoretical work on board independence.

4.1 Knowledge and Power

It is usually expected that a positive association exists between the knowledge and skills an individual possesses with his independence in actions. World's leading credit rating organization Moody's in its report titled 'Criteria for Assessing Director Independence' mentions that "We expect that a high level of board independence is matched with sufficiently knowledgeable and engaged directors who can hold management to account."

Fogel, Ma, and Morck (2014) examined whether "powerful" directors behave independently in the board. They defined powerful directors to be those with large professional networks. After examining a sample of 19,223 unique directors from 1998-2010, they found that Powerful directors were associated with more valuable merger-and-acquisition activities and stricter oversight of CEO performance. In addition, powerful directors were associated with less earnings management. They also found that shareholders tend to react negatively to the sudden death of any powerful directors. Taken together, powerful directors exhibit greater independence. On the other

hand, Moody's put forth in 'Criteria for Assessing Director Independence' that sometimes directors with greater sector experience appear to have potential conflicts and this may impair their independence. However, knowledge of industry or expertise and independence are addressed as factors that are not necessarily mutually exclusive (Alex Frino, 2016).

H1: Board independence is positively related to the knowledge and power of independent directors.

4.2 Firm size

It is often argued that larger firms generally adopt stricter monitoring mechanisms, implying more demand on governance tools like audit committee and board independence (Klein 2002). Fama and Jensen (1983) show that larger and more hierarchical firms results from process that are either larger or more complex or both and as a result, larger firms need larger board to provide CEO appropriate advice and necessary access to information as well as resources. This finding suggests that firms with a relatively complex form of operations require a bigger and more independent board. Lehn et al. (2004) also suggest that as the scale and complexity of the firm increase, board independence has to increase as well in order to cater to the greater information needs. Also, it is argued by Anderson et al. (2000) and Coles et al. (2005) that more diversified firms tend to have more IDs in order to carry out the monitoring role expected of them. Considering all these findings, we hypothesize a positive relationship between firm size and board independence.

H2: Board independence is positively related to firm size.

4.3 Financial leverage

A firm with leverage tends to have greater pressure from the creditors to put more transparent governance mechanisms in place so as to safeguard the interest of the creditors and lenders. In Japanese organizations, there is often representation in the board from the creditors while other countries often require greater outside representation (i.e. greater independence) in the board. This is an implication of the debt covenant hypothesis that managers in levered firms with debt covenants tend to manipulate earnings to either delay or even avoid potential violation of debt contracts. For example, Dechow et al. (1996) report that managers have shown tendency to overstate reported earnings in the year before violations of debt covenants. Thus creditors demand greater board independence in a firm with financial leverage. Another view consistent with this hypothesis is that a more complex business is usually a levered one. And as we have mentioned in the previous hypothesis, more complex business requires more independent directors. Thus the third hypothesis becomes:

H3: Board independence is positively related to financial leverage.

4.4 Growth opportunities

Firms that have experienced rapid growth may, at one point, outgrow the infrastructure as well as the internal control system they have. According to Klein (2002) firms that are growing are associated with more uncertainties and greater complexities. He reports that such growing firms generally rely less on independent directors and more on insider directors. Consistent with his findings, Klein (2002) expects lower demand on board independence from both management and shareholders of firms with high growth opportunities. Linck et al. (2008) also show that firms with higher growth opportunities tend to have less independence in the board. This study uses market to book ratio as a proxy for growth. Consequently the hypothesis becomes:

H4: Board independence is negatively related to firm's growth opportunities.

4.5 Profitability

This study recognizes profitability as having an important link with board independence. Adhikary and Mitra (2016) hypothesized that when there is a possibility of private gain for insiders, firms should employ more independent directors in audit committee. From that hypothesis, it is reasonable to conclude that insiders have incentives to manipulate firm profitability to serve self-interests. As a result, greater internal control and stricter

governance mechanism should be put in place to curb such self-interested behavior and obviously this brings back the role of independent directors as a control mechanism. So, our next hypothesis is as follows:

H5: Board independence is positively related to the profitability of a firm.

4.6 Firm age

Linck et al. (2008) demonstrate that when insiders have greater opportunity to derive much of private benefit, firms employ greater number of outside independent directors. Generally older firms develop stricter and more efficient internal mechanisms to bar insiders from extracting such private benefits in comparison to younger firms with low initial investments in developing sophisticated monitoring mechanisms. Thus, we expect older firms to have much less demand for independent directors as a tool to enhance governance and the related hypothesis is:

H6: Board independence is negatively related to firm age.

4.7 Board size

Some authors reported that a reasonably larger board combines varying degree of knowledge and experience of directors and add more value to the firm making a larger board more desirable. In addition, both Collier (1993) and Beasley and Salterio (2001) reported that keeping pace with the increase in board size, the ability of a firm to employ more independent directors increase. Moreover, Adhikary and Mitra (2016) found that firms with larger board had more independent audit committee. On the other hand, it is also argued that monitoring role is stronger in a smaller board and it is less probable that the board be captured by the CEO when it is small. Besides, a general reasoning follows from the field of Origination Behavior (OB) that people tend to be less independent and show more conformity while surrounded by a large number of people having opposite ideas. Following these opposite ideas, we hypothesize that board independence has association with board size without predicting about the direction of association.

H7: Board independence is related to board size.

4.8 Board meetings

Board meeting is a very important part of the overall functioning of many governance mechanisms. In fact, Van den Berghe & Levrau (2003) show that directors themselves put tremendous importance on the quality of board meetings followed only by board composition while judging the elements of good BoD. More frequency in board meetings is a sign that issues of corporate governance are being reviewed more frequently. This also keeps the role of independent directors' a rolling stone that has little chance to gather moss. Thus it might be a positive sign for the governance and work well to the advantage of an ID to demonstrate his independent views regarding different issues. Contrary to the notion imbibed above, more board meetings mean more sitting charge to IDs and the number of board meetings might thus latently be used by the insiders to transfer significant pecuniary benefits to the independent directors even within the legal bounds. Thus the number of board meetings might be used by insiders as a loophole to financially capture the independence of IDs. Considering this view, we hypothesize the following relationship to exist between the number of board meetings and board independence without any specific direction.

H8: Board independence is related to the number of board meetings.

4.9 Board gender diversity

Bohren and Staubo (2015) reported that a 40% mandatory female quota in the board was associated with an increase in board independence. Empirically they found that after such a quota, average fraction of IDs jumped from 67% from 46%. They conveyed that female directors are, indeed, much more often independent directors in comparison to male directors. Thus, I hypothesize that the fraction of female directors in the board is positively related to board independence.

H9: Board independence is positively related to the ratio of female directors in the board.

4.10 Tenure

As IDs tend to have longer tenure in the board, the information gap generally subsides and IDs become more acquainted with the operations and governance of the firm by getting more exposure to inside information. Thus over time, IDs can pile up their firm specific knowledge and information (Vance, 1983) which, in turn, enhances their commitment and dedication to the firm as well as improves ID competence (Buchanan, 1974). Thus longer tenure may be expected to have favorably affected independence. Contrary to this view, (Vafeas, 2003) argues that the longer an ID serves in a board, the more personal connections he develops with management and their relationship becomes cozy. This perspective holds the view that the longer the tenure, the more the possibility of independence being compromised and the easier it is for management to capture the ID. Consequently, regulators, advocate of governance and many large institutions hold a skeptical view of IDs serving longer tenure. Consistent with this 'Compromise view', CG guidelines issued by SEC in 2012 calls for rotation of IDs after only one renewal of the 3 year serving period. So, a more rational hypothesis is the possibility of a positive or negative association between board independence and the tenure of independent director.

H10: Board independence is associated with tenure of the independent directors.

4.11 Relationship with the firm

Whether or not an ID is already related with the firm is an important factor that tentatively is expected to affect the degree of actual independence an ID can subsequently demonstrate. Moody's considers that prior connection with firm or even with other directors or management of the firm is a sign of a potential compromise with freedom for independent directors. But this doesn't necessarily always constitute a hindrance to independence. Rather, it is argued that some sort of relationship with the firm, as long as it is not extensive enough to capture the independence of the directors, is good for the improvement of monitoring activity on the part of an ID. This is backed by the fact that firm specific knowledge is important for an ID to ensure that the loopholes management uses to maximize self-interest at the cost of owners are better mended. And such expertise often requires a mild connection of independent directors with the firm. Moreover, if an ID is a total alien to the firm, chances are there that he will find it monotonous to execute his duties with genuine and diligent interest. As a consequence, different acts and governance guidelines often allow a small stake of the ID in the firm (i.e. 2012 SEC CG notification allows an ID to hold less than 1% of the paid up capital of the firm). Thus, we don't ascertain the sign but instead hypothesize the following with respect to ID prior relation with the firm in general:

H11: Board independence is related to prior relationship of independent directors with firm.

5. Research Design

5.1 Sample Description and Data Collection

In order to test the hypotheses, we have used a sample of 30 (thirty) listed banks from the banking sector of Bangladesh that constitutes with a total 56 banks classified into 6 state-owned banks, 2 specialized banks, 39 private commercial banks and 9 foreign commercial banks. Even though our sample constitutes 53.57 % of the total number of banks (excluding Bangladesh Bank), it covers all the banks that are listed in Dhaka Stock Exchange (DSE).

We resort to secondary source while collecting the data required for the study. All data come from the published annual reports of the banks which are publicly available. In order to collect the data we have extensively analyzed the annual reports of the banks from the period 2006 (when for the first time SEC issued the corporate governance guidelines) to 2016 (which is the latest year for which annual reports are available online for all the banks).

As mentioned earlier, several factors motivate us to choose the banking sector as the field of analysis in this study. Among them, the most important factor was the stringent regulation that the banking sector is subject to. Banks in Bangladesh are under extensive regulatory pressure and strict monitoring as they, unlike most other business, employ greater amount of public wealth and trust. In order to retain the confidence and faith of the greater mass of the country, the regulatory agencies and the government must find some path to ensure superior governance,

transparency, and accountability in this sector. Thus we expect banks to have a more sound set of governance mechanisms than do other sectors. With this expectation, the results of this study must have significant bearing for several parties including the government, regulators (Bangladesh Bank, BSEC etc.), management, as well as the general public who engage in day to day transactions with and take services of the banks. Finally, the results of the analysis done with the most strictly controlled banking sector might be a benchmark for deducing how well or bad the other sectors might be doing in appointing independent directors.

5.2 Variable Definition

Table II, summarizes the dependent and all the independent variables of the model we develop and also includes their definition as well as the expected nature of relationship with board independence:

Table II: Description of the research variables

<i>Variables</i>	<i>Acronym</i>	<i>Definition</i>	<i>Expected Sign</i>
Dependent Variable			
Board Independence	BODIND	Total number of independent directors divided by total number of board members	
Independent Variables			
Knowledge and Power	KNG	Dummy variable that takes 1 if all the IDs in the board have the knowledge required by SEC Notification 2012, and 0 otherwise	+
Firm Size	SIZE	Natural log of total assets	+
Financial Leverage	LEV	Total liabilities to total assets ratio	+
Growth Opportunities	MB	Ratio of market value of equity to book value of equity	-
Profitability	ROA	Net profit divided by average total assets	+
Firm Age	AGE	Natural log of the age of the firm	-
Board Size	BOD	Number of members of the board of directors.	+/-
Board Meetings	BMT	Number of board meetings held in the reporting year	+/-
Board Gender Diversity	GEN	Proportion of female directors in the board	+
Tenure	TNR	A dummy variable that takes 1 if any ID in the board has served for 6 or more years, and 0 otherwise	+/-
Relationship with Firm	REL	A dummy variable that takes 1 if any ID in the board is related to either the firm, management or other directors, and 0 otherwise.	+/-

5.3 Regression model and estimation method

Using all the identified variables we develop and estimate an econometric model to determine the significant factors likely to affect the board independence in the banking sector of Bangladesh. The regression model is as follow:

$$BODIND = \alpha + \beta_1 KNG + \beta_2 SIZE + \beta_3 LEV + \beta_4 MB + \beta_5 ROA + \beta_6 AGE + \beta_7 BOD + \beta_8 BMT + \beta_9 GEN + \beta_{10} TNR + \beta_{11} REL + \varepsilon$$

Before estimating the multivariate regression model, we examine the “multicollinearity effect” using Pearson’s correlation matrix and VIF. Both methods ensure that the model has not been unnecessarily extended by considering variables that capture homogenous concepts. Since data structure of this study corresponds to panel data covering thirty listed banks over eleven years period, we run both pooled OLS regression and robust regression with observations being clustered into firm level and year level (known as two-way clustering) to take into consideration both the cross-sectional and the time series nature of the data and to control for heteroskedasticity. The two-way clustered method adjusts the standard error of the pooled OLS method to reflect cross-sectional and time-series relation of the data. However, the robust clustered regression doesn’t differ significantly from the pooled OLS multivariate regression except for two variables. The results of estimation are described in the next section.

6. Discussion of Empirical Results

6.1 Descriptive Statistics

Table III summarizes the descriptive statistics for the variables used in the regression model. According to the table, on an average 62% of the independent directors serving in the board of the banking companies in Bangladesh have the educational qualifications required by BSEC guidelines for corporate governance. The average total asset of the firms is found to be 99,707.88 million BDT and the mean leverage of the firms is 93%, a very high one and is justified because of the nature of the industry. On average, a share is traded at 2.5 times high compared to its book value and return on asset is 1.3 percent. Around 18% of the IDs are somehow related to the firms they are serving indicating a probable and harmful nexus between management and ID under the compromise view of CG. But viewed from another angle, this relationship can improve the IDs knowledge about the firm and thus they have more scope to come up with value addition services to the firm by the incorporation of their firm specific knowledge and experience as well as a better sense of dedication and attachment to the welfare of the firm. In regard to board meetings, the average number is around 18 which is a decent number. We also find that average presence of female member in the board is 10% which has run to a highest of 75%. Another important finding of this study is that 8% of the IDs have either reached or exceeded the prescribed tenure mentioned by SEC that is six years at a stretch. The rest 92% of the IDs have not been in appointment for more than 2 consecutive periods.

Table III: Descriptive statistics

<i>Variables</i>	<i>N</i>	<i>Mean</i>	<i>Standard Deviation</i>	<i>Min</i>	<i>Max</i>
<i>BODIND</i>	329	0.099	.099	0	0.43
<i>KNG</i>	330	0.62	0.48	0	1
<i>SIZE*</i>	330	99707.88	2.248	12708.17	1498537.21
<i>LEV</i>	330	0.93	0.11	0.009	1.76
<i>MB</i>	329	2.46	4.23	-0.43	36.47
<i>ROA</i>	329	0.013	0.02	-0.23	0.23

<i>AGE</i>	330	10.28	2.46	0	33.12
<i>BOD</i>	330	13.19	1.36	4.95	27.93
<i>BMT</i>	329	17.63	1.16	3.98	61.56
<i>GEN</i>	330	0.10	0.11	0	0.75
<i>TNR</i>	330	0.08	0.27	0	1
<i>REL</i>	330	0.18	0.39	0	1

* Figure is in million BDT

Finally, the degree of board independence as measured by their proportion in the board is found to be 10% on average which runs as high as 43% while there are boards with no ID and apparently no board independence. This phenomenon actually was prevalent in the banking sector during the period of 2006 to 2008 in most of the banks due to the lack of a stringent rule requiring independence in the board. But the situation dramatically improved after the 2012 revised notification on CG issued by BSEC. Still, Bangladesh is lagging behind in ensuring the proper representation of independence from the ID mechanism as long as the suggestion of Raghunandan and Rama (2007) is concerned that calls for at least 50% of the board to be represented by non-executive directors to ensure sound governance of the firm.

6.2 Correlation Analysis

Before moving into the main analysis, we check the Pearson correlation coefficient among the variables. The following table (Table IV) reports the presence of no independent variables in the model that has significant relationship with any other variables here. This univariate correlation suggests that board independence is positively and significantly correlated with knowledge of independent directors, firm size, firm age, gender diversity, tenure of independent directors and their relationship with the firm while board independence has significant negative relationship with market to book ratio and board size. However, no significant relation is found for financial leverage, operating performance and number of board meetings.

Table IV: Pearson Correlation Coefficient

	1	2	3	4	5	6	7	8	9	10	11	12
1	1											
2	0.57	1										
3	0.11	-0.04	1									
4	0.55	0.51	-0.01	1								
5	-0.02	-0.02	0.01	-0.38	1							
6	-0.17	-0.07	-0.09	-0.16	-0.03	1						
7	-0.04	0.04	0.03	0.09	-0.40	0.12	1					
8	0.15	0.32	-0.28	0.49	0.06	-0.09	-0.05	1				
9	-0.20	-0.10	-0.13	0.25	-0.38	-0.02	0.21	0.07	1			
10	0.01	0.18	-0.03	0.32	-0.30	0.05	0.18	0.33	0.23	1		
11	0.37	0.20	0.07	0.25	-0.06	-0.05	0.009	0.09	-0.05	0.03	1	
12	0.38	0.16	0.09	0.15	-0.06	-0.07	0.01	-0.05	-0.00	0.02	0.22	1

1. BODIN 2. KNG 3. GEN 4. SIZE 5. LEV 6. MB 7. ROA 8. AGE 9. BOD 10. BMT 11. TNR 12.REL

6.3 Result of Multivariate Analysis

We estimate the regression model using both pooled OLS method and two-way clustered method. While the results do not differ significantly, we report only the results of clustered regression analysis since this method corrects the standard errors for possible relation among variables across firms and over time commonly detected in panel data setting, and produces more robust and conservative standard errors. The results are presented in table V. We find the F-statistic of the model developed in this study to be highly significant ($F=44.94$, $P < 0.0001$) indicating overall significance of the model. Both R^2 and adjusted R^2 have reasonably high values respectively being 0.63 and 0.59. This is an indication that around 59% of the total variation in board independence can be explained by the set of independent variables used in the model. Moreover, the low value of Root MSE indicates greater accuracy of the model.

Table V: Results of Multivariate Regression
(Linear regression with two-way clustered SEs)

Variable	Expected sign	Coefficient	Standard error	t-statistic	P> t
Intercept		-0.52352***	0.15077	-3.47	0.001
KNG	+	0.05663***	0.01176	4.82	0.000
SIZE	+	0.06642***	0.01368	4.86	0.000
LEV	+	0.09101**	0.03605	2.52	0.012
MB	-	-0.00130	0.00085	-1.53	0.127
ROA	+	-0.04865	0.15657	-0.31	0.756
AGE	-	-0.01829***	0.00695	-2.63	0.009
BOD	+/-	-0.07210**	0.02955	-2.44	0.015
BMT	+/-	-0.01565*	0.00819	-1.91	0.057
GEN	+	0.01666	0.04788	0.35	0.728
TNR	+/-	0.04996**	0.02465	2.03	0.044
REL	+/-	0.05526***	0.00989	5.59	0.000

N	329	Number of clusters (firm)	30
F-statistic (11, 317)	44.94	Number of clusters (year)	11
Prob. > F	0.0000	Root MSE	0.0615
R-square	0.63		
Adj. R-square	0.59		

***, **, * represents significance level at 1, 5 and 10 percent respectively.

The results indicate that board independence has significant positive relationship with ID knowledge, firm size, leverage, tenure and ID relationship with the firm. These results are in line with the hypotheses that -

- A board is likely to be more independent when independent directors have relevant skill and knowledge as required by prevailing corporate governance regulation. [Fogel, Ma, and Morck (2014)]
- Bigger firms employ more independent directors in order to ensure that a stringent monitoring role is carried out by them (Klein, 2002)
- Greater leverage turns out to be a reason for demanding stringent monitoring by creditors which in turn requires more independence in the board.

- Longer tenure enhances the firm specific knowledge of the independent directors (Vance, 1983) and this in turn improves the dedication and commitment of the ID to the firm as well as improves competence (Buchanan, 1974).
- The positive association between board independence and the existence of any relationship between the ID and the firm might be explained by fact that some sort of attachment with the firm is necessary for the part of the ID in order for them to have a greater degree of care for the sound governance of the firm. If IDs do not at all have any sort of relationship or attachment with the firm they serve in, it would be a dull responsibility for them to carry out and they would apparently lose interest in executing their duty properly.

On the other hand, this study finds significant negative relationship of board independence with firm age, board size and board meetings. Over times, older firms tend to develop more efficient internal control and monitoring systems that are apt in ensuring sound governance. The capability of older firms to demonstrate much maturity in controlling management's ability to extract private benefit (i.e. in the form of using up free cash flow for office amenities) from the firms leads to a lower demand on the board independence as a mainstream governance mechanism. Thus, matured firms develop stronger substitutes to ID and the negative association of firm age with board independence seems a fairly justified one. Similarly, the negative association of board size and board activity with board independence suggests that these board characteristics seem to work against board independence. One possible explanation might be that a firm is less likely to appoint new independent directors in response to increase in the number of board members or board meetings.

However, this study doesn't find any significant relationship of board independence with growth opportunities, profitability and gender diversification (presence of female members) in the board. The coefficients on these three variables are not statistically significant at the conventional level. Thus, this study indicates that growth opportunities (as measured by market to book ratio), firm profitability (as measured by ROA) and gender diversity (as measured by the proportion of female directors on the board) do not materially affect board independence in the banking sector of Bangladesh.

7. Conclusion

This study has attempted to identify the determinants of board independence measured by proportion of independent directors on the board in the banking sector of Bangladesh. This examination has applied a panel data analysis for DSE listed 30 scheduled banks that deliver the information necessary for analysis from 2006 to 2016. The results of this study show that boards tend to be more independent when they have independent directors with relevant skill and educational background. Firm specific factors that positively influence the independence of the board are larger size of firms and a relatively higher financial leverage. This study reports that board structure plays an important role in determining the level of board independence. Another vital finding conveys that the greater the board size, the lower is its independence. Contrary to the tentative expectation, longer tenure and relationship of independent directors with the firm have been found to enhance independence instead of decaying it. But it would be wise to be cautious in interpreting this result because too much increase in these two variables might create hindrance to independence. Finally, this study doesn't find any statistically significant relationship of board independence with profitability, growth opportunities of the firm and gender diversification in the board. Finally this paper confines its focus to the determinants of board independence without attempting to explain or predict the consequences of such. The concept of independent director has attained extensive popularity and importance in ensuring proper functioning of the board and other internal governance mechanisms in a firm. Thus this study might be helpful in undertaking future research such as determining various regulatory and performance implications of this concept, testing the attributes of independent directors with firm performance, examining the usefulness of having more independent boards and so on.

References

- Abdullah S., Abidin N.Z., Bakar I.A. and Rahman, A. (2016), "The Appointment Process for Independent Directors in Malaysian Listed Companies", *Corporate Ownership and Control*, 14(1).
- Adhikary, B. and Mitra, R. (2016), "Determinants of Audit Committee Independence in the Financial Sector of Bangladesh", *Applied Finance and Accounting*, 2(2), pp. 46.
- Al-Najjar, B. (2011), "The Determinants of Audit Committee Independence and Activity: Evidence from the UK", *International Journal of Auditing*, 15(2), pp.191-203.
- Altuwajri, B. and Kalyanaraman, L. (2016), "Is Excess Board Independence Good for Firm Performance? An Empirical Investigation of Non-Financial Listed Firms in Saudi Arabia", *SSRN Electronic Journal*.
- Aspris, A. and Frino, A. (2011), "Board Independence, Stock Liquidity, and Price Efficiency", *SSRN Electronic Journal*.
- Bainbridge, S. (2002), "A Critique of the NYSE's Director Independence Listing Standards", *SSRN Electronic Journal*.
- Balasubramanian, B. (2017), "Director Independence in Controlled Companies - The Way Forward", *SSRN Electronic Journal*.
- Bhagat, S. and Black, B. (1998), "The Non-Correlation Between Board Independence and Long-Term Firm Performance", *SSRN Electronic Journal*.
- Ltd, A. (2018), "The importance of independent directors", *Times of Malta*. Available at: <https://www.timesofmalta.com/articles/view/20140213/business-comment/The-importance-of-independent-directors.506609> [Accessed 16 Feb. 2018].
- Brickley, J., Coles, J. and Terry, R. (1994), "Outside directors and the Adoption of Poison Pills", *Journal of Financial Economics*, 35(3), pp. 371-390.
- Broughman, B. (2008), "The Role of Independent Directors in VC-Backed Firms", *SSRN Electronic Journal*.
- Byrd, J. and Hickman, K. (1992), "Do Outside Directors Monitor Managers?", *Journal of Financial Economics*, 32(2), pp. 195-221.
- Cai, Y., Xu, J. and Yang, J. (2016), "Affiliated Corporate Donations and Director Independence", *SSRN Electronic Journal*.
- Chatterjee, D. (2009), "Independent Directors and Current Legal Perspectives in India", *SSRN Electronic Journal*.
- Chen, L. and Moers, F. (2011), "The Market for Independent Directors", *SSRN Electronic Journal*.
- Clarke, D. (2006), "Setting the Record Straight: Three Concepts of the Independent Director", *SSRN Electronic Journal*.
- Clifford, P. and Evans, R. (1997), "Non-Executive Directors: A Question of Independence", *Corporate Governance*, 5(4), pp.224-231.
- Cohen, L., Frazzini, A. and Malloy, C. (2009), "Hiring Cheerleaders: Board Appointments of 'Independent' Directors", *SSRN Electronic Journal*.
- Cukurova, S. (2014), "What Do Outside Directors Learn Around Annual Meetings? Evidence from Insider Trading", *SSRN Electronic Journal*.
- Dou, Y., Sahgal, S. and Zhang, E. (2015), "Should Independent Directors Have Term Limits? The Role of Experience in Corporate Governance", *Financial Management*, 44(3), pp. 583-621.
- Ebrahim, A. and Black, H. (2013), "Board Independence Impact on Insider Trading, Before and After SOX", *SSRN Electronic Journal*.
- Ey.com. (2018)., "Role of Independent Directors in Corporate Governance", *EY India* [online] Available at: <http://www.ey.com/in/en/services/assurance/fraud-investigation---dispute-services/corporate-governance--role-of-independent-directors> [Accessed 16 Feb. 2018].
- Fama, E. (1980), "Agency Problems and the Theory of the Firm", *Journal of Political Economy*, 88(2), pp. 288-307.
- Fama, E. and French, K. (1992), "The Cross-Section of Expected Stock Returns" *The Journal of Finance*, 47(2), p. 427.
- Fama, E. and Jensen, M. (1998), "Separation of Ownership and Control", *SSRN Electronic Journal*.
- Fogel, K., Ma, L. and Morck, R. (2014), "Powerful Independent Directors", *SSRN Electronic Journal*.
- Germain, L., Galy, N. and Lee, W. (2012), "The Determinants of Corporate Board Size and Independence: Evidence from Malaysia", *SSRN Electronic Journal*.
- Gutierrez, U.M. and SaezLacave, M. (2012), "Deconstructing Independent Directors", *SSRN Electronic Journal*.
- Jenwittayaroje, N. and Jiraporn, P. (2017), "Do Independent Directors Improve Firm Value? Evidence from the Great Recession", *International Review of Finance*.
- Johanson, D. and Ostergren, K. (2010), "The Movement Toward Independent Directors on Boards: A Comparative Analysis of Sweden and the UK", *Corporate Governance: An International Review*, 18(6), pp. 527-539.

- Kang, S. (2013), "Experienced Independent Directors", SSRN Electronic Journal.
- Kanagaretnam, K., Lobo, G. and Whalen, D. (2013), "Relationship between Board Independence and Firm Performance Post Sarbanes Oxley", *Corporate Ownership and Control*, 11(1).
- Keasey, K. and Hudson, R. (2002), "Non-executive Directors and the Higgs Consultation Paper, Review of the Role and Effectiveness of Non-executive Directors" *Journal of Financial Regulation and Compliance*, 10(4), pp.361-371.
- King, R. and Peng, Q. (2007), "Does the Reputation of Independent Non-Executive Directors Matter: Evidence from Hong Kong", SSRN Electronic Journal.
- Klein, A. (1998), "Firm Performance and Board Committee Structure", *The Journal of Law and Economics*, 41(1), pp. 275-304.
- Kossoff, K. (1983), "Director Independence and Derivative Suit Settlements", *Duke Law Journal*, 1983(3), p. 645.
- Kumar, N. and Singh, J. (2012), "Outside Directors, Corporate Governance and Firm Performance: Empirical Evidence from India", *Asian Journal of Finance & Accounting*, 4(2).
- Lai, B. (2014), "Are Independent Directors Effective Corporate Monitors? An Analysis of the Empirical Evidence in the USA and Canada", SSRN Electronic Journal.
- Laux, V. (2008), "Board Independence and CEO Turnover", *Journal of Accounting Research*, 46(1), pp. 137-171.
- Liu, W. (2011), "Board Independence and Long-Term Firm Performance: The Initial Quest of Effective Board Paradigm - A Survey Based on Nonlinear Regression Equation Modeling", SSRN Electronic Journal.
- Ltd, A. (2018), "The importance of independent directors", *Times of Malta*, Available at: <https://www.timesofmalta.com/articles/view/20140213/business-comment/The-importance-of-independent-directors.506609> [Accessed 16 Feb. 2018].
- Ma, J. and Khanna, T. (2015), "Independent directors' dissent on boards: Evidence from listed companies in China", *Strategic Management Journal*, 37(8), pp. 1547-1557.
- McLean, R. (1997), "Agency Problems, Equity Ownership, and Corporate Diversification", *CFA Digest*, 27(4), pp. 49-51.
- Nguyen, T., Evans, E. and Lu, M. (2017), "Independent directors, ownership concentration and firm performance in listed companies", *Pacific Accounting Review*, 29(2), pp. 204-226.
- Peecher, M., Rowe, S. and Sivadasan, P. (2015), "Are All Outside Directors Independent? An Investigation of the Compliant Director Market", SSRN Electronic Journal.
- Pichet, E. (2013), "Defining and Selecting Independent Directors", SSRN Electronic Journal.
- Podder, J., Skully, M. and Brown, K. (2013), "Independent Directors and Risk Taking: Evidence from Listed US Insurance Companies", SSRN Electronic Journal.
- Ramdani, D. and Witteloostuijn, A. (2010), "The Impact of Board Independence and CEO Duality on Firm Performance: A Quantile Regression Analysis for Indonesia, Malaysia, South Korea and Thailand", *British Journal of Management*, 21(3), pp. 607-627.
- Ravina, E. and Sapienza, P. (2008), "What Do Independent Directors Know? Evidence from Their Trading", SSRN Electronic Journal.
- Santella, P., Drago, C. and Paone, G. (2007), "Who Cares About Director Independence?", SSRN Electronic Journal.
- Santella, P., Paone, G. and Drago, C. (2006), "How Independent are Independent Directors? The Case of Italy", SSRN Electronic Journal.
- Stein, G. and Plaza, S. (2011), "The Role of the Independent Director in CEO Supervision and Turnover", *Corporate Ownership and Control*, 9(1).
- The Report of the Cadbury Committee on the Financial Aspects of Corporate Governance: The Code of Best Practice, (1993), *Corporate Governance: An International Review*, 1(3), pp.124-124.
- Wan, K. (2003), "Independent Directors, Executive Pay, and Firm Performance", SSRN Electronic Journal.
- Wang, Y. and Young, A. (2010), "Does Firm Performance Affect Board Independence?", *Corporate Board: Role, Duties and Composition*, 6(2).
- Ye, K. (2014), "Independent Director Cash Compensation and Earnings Management", *Journal of Accounting and Public Policy*, 33(4), pp. 391-400.
- Zhang, X. and Zhou, F. (2010), "How Do Companies Adjust their Independent Directors after a Mishap - Evidence from Independent Directors' Background", *Journal of Service Science and Management*, 03(03), pp. 336-344.



The Effect of Specific Factors on Bank Profitability: Evidence from Nepalese Banks

Prem Bahadur Budhathoki¹, Chandra Kumar Rai²

¹Mahendra Multiple Campus, Dharan, Tribhuvan University, Nepal

²Mahendra Multiple Campus, Dharan, Tribhuvan University, Nepal

Correspondence: Prem Bahadur Budhathoki, Mahendra Multiple Campus Dharan, Tribhuvan University, Nepal.
Tel: 977-025521546 Email: pravabbudhathoki@gmail.com

Abstract

This paper examines the impact of assets quality, capital adequacy ratio, assets diversification and operating efficiency on banks' profitability. This study employs bank scope data of eight commercial banks during the period of 2002/03 – 2016/17. Altogether, there are 96 observations are made in the study. The ordinary least squares model is used to analyze the data. The results indicate that three predictor variables assets quality, operating efficiency, and capital adequacy ratio significantly affect bank profitability. But the predictor variable diversification does not affect banks' profitability significantly. The results of this study help the bankers and policymakers to take effective action in order to improve banks' profitability.

Keywords: Capitalization, Asset Quality, Operating Efficiency, Bank Diversification

1. Introduction

Nepal government initiated financial rector reform in the mid-1980s and had implemented a comprehensive financial sector program in 2001 (Shrestha, 2004). The objectives of these reforms were to create an efficient, competitive, transparent, discipline and profitable banking sector to foster economic growth of the nation. Since the liberalization, the Nepalese financial sector widened. The elimination of government intervention and private sector participation has significantly contributed to this expansion (Bhetuwal, 2007). This widened financial sector brings a large number of financial institutions and has created intense competition among them (Panta, 205). The fierce competition within financial institutions brings both opportunities and threats to the economy. Intense competition within financial institutions may increase or decrease the banks' profitability. While the banks cannot generate sufficient profit to run the business, then they become insolvent and increase financial instability. Further, it brings contaminate effects in the financial system. When any financial institution develops serious problems that reach public notice, the public's confidence in other financial institutions may be damaged as well (Rose, 2002). The results may be serious due to the smaller flow of saving to investment which adversely affects the job opportunity and economic growth rate. Nepal has a bank dominated economy (Kharel & Pokhrel,

2012). The role of banking sectors in bank dominated economy is more than the capital dominated economy. The success of the commercial banking sector plays a key role in promoting economic growth in Nepal. Therefore, Profit is essential to survive in the long-run. There are two important conflicting paradigms regarding the banks' profitability: Structure-Conduct-Performance (SCP) hypothesis and Efficient Structure (ES) hypothesis. On the one hand, the SCP hypothesis argues that a smaller number of firms operating in the market have the ability to obtain higher profit through the collusion among banks. In other words, they can obtain more profit by charging higher loan rates and offering low deposit rates (Tan & Floros, 2014). On the other hand, ES structure hypothesis argues that efficient banks can produce large varieties of service products at a lower cost, able to compete more aggressively in the competitive market, capture a bigger market share (Tan & Floros, 2014) allow banks to increase their size (Curak, Poposki & Pepur, 2012) and get an advantage of economies of scale to earn high profit. Similarly, there are two contrasting views regarding the association between capital and profitability. On the one hand, the signaling hypothesis states that the high capital of banks conveys positive signals in the market. If the debtors and depositors take it positively then the cost of funds might decrease and banks' profit increases.

Banks with higher capital are capable of absorbing any negative shocks and assumed to possess less insolvency. Higher capital may also incentivize shareholders to monitor management activities; therefore lower the probability of taking an excessive risk by managers (Ahemed, 2017). On the other hand, the risk-return hypothesis states that there is a direct relationship exist between risk and return; a higher capital ratio decreases the risk of the firms and leads to lower performance of the banks. Additionally, the trade-off theory states that greater the use of debt (lower the use of equity) increases the banks' interest expenses and the bank may not able to meet its financial duties on time. Consequently, the required rate of return on new capital will increase and the probability of bankruptcy cost also increases which reduce bank profitability (Saona, 2016).

Basically, it can be expected that there is a positive relationship between asset quality and bank performance. In other words, there is an inverse relationship existing between provision for loan loss ratio and ROA and NIM. Bank asset quality has been responsible for the success or failure of the bank. The best measure for assessing the quality of assets is loan loss provisions to loan ratio. Loan loss provision is the ratio of the loan loss provisions to loans, a measure of the quality of loans granted by banks (Damtsa, Milidonis, & Stathopoulos, 2019). There are two contrasting facts regarding the relationship between asset quality and banks' profitability. On the one hand, some scholars argue that the decreases of assets quality increase the proportion of non-performing assets, possible loan loss provision and monitoring cost of the banks; which leads to a decrease in banks' profitability. On the other hand, some scholars argue that the decreases of assets quality increase the loan loss provision, and increase default loss which can be compensated through higher interest margin because high risk should pay high prices to the banking services (Saona, 2016).

Basically, it can be expected that there is an inverse relationship between operating efficiency (lower cost to income ratio) and bank performance. There are two contrasting facts regarding the relationship between operating efficiency and banks' profitability. On the one hand, it can be expected that the operating cost is positively related to bank profitability with regards to ROA and NIM. This statement can be explained by the fact that profit is the difference between total revenue and total cost which clearly states that high operating cost reduces the banks' profitability. On the other hand, opponents of this arguments states that large volume of operating expenses is derived from paying salaries and wages to staff, while higher levels of salaries and wages paid to staff significantly improve the staff productivity, while the resulting improvement in the bank profitability is much larger than the salaries and wages paid out by the bank (Tan, 2016). In other words, the higher level of wages and salaries increase the employees' loyalty, decrease the supervision cost, and attract high-quality workers to the banks. All the factors that impact banks' profitability mainly studied in developed and developing countries but very few kinds of literature are found in the context of low-income countries such as Nepal. Therefore, the aim of this study is to examine the impact of capitalization, asset quality, operating efficiency, and bank diversification on the profitability of Nepalese commercial banks.

2. Literature Review

2.1 Capitalization and bank profitability

Bank capital is considered as one of the important factors affecting bank profitability. The bank's equity capital directly influences the rate of return on equity. The leverage ratio can affect the growth rate of the bank also. In the extreme, if losses exceeded bank capital, the bank would be insolvent and subject to closure by the chartering agency (Gup & Kolari, 2012). The capital fund of the commercial bank plays several roles: first, it protects banks from insolvency risk. Second, capital promotes public confidence in a bank and reassures its creditors (including depositors) of the bank's financial strength. Third, the capital provides funds for the organization's growth and development of new services, programs, and facilities. Fifth, capital serves as regulators of bank growth. Finally, it protects the government's deposit insurance system from series losses (Rose, 2002). Existing literature reveals two contrasting empirical pieces of evidence of capitalization on bank profitability. In the one extreme, it is expected that there is direct association between capital ratio and bank's profitability because it reduced the funding cost due to the fact that it increases banks' creditworthiness; the banks with higher capital levels are more likely to engage in prudent lending; capital plays an important role in absorbing the risk arising from higher-risk assets, such as loans; and the banks with higher capital levels need to borrow less, which reduce cost and further increases profitability (Tan, 2016). A study conducted by Trad, Trabelsi, & Goux in 2017 entitled 'Risk and profitability of Islamic banks: A religious or an alternative solution?' and found a positive and very significant effect of capital on banks' profitability. They argued that a significant level of capital makes for better protection against banking crises. In light of these results, it seems that capital adequacy was a safety valve and a guarantee of bank profitability and stability. Therefore, the bank should maintain a minimum capital to ensure sufficient funds against unexpected losses and negative shocks (p. 43). Similarly, Ahamed in 2017 found that larger banks, greater equity capital, and greater composition of assets in the form of loans are positively and significantly associated with profits and risk-adjusted assets. But a study conducted by Patria, Capraru & Ihnatov in 2015 entitled 'Determinants of banks' profitability: Evidence from EU 27 banking system' and found an insignificant relationship between capital adequacy ratio and shareholders' return. They argued that a high capital adequacy ratio may reduce the risk of the banks but at the same time they would not get the benefit of the leverage effect. In another extreme, Saona in 2016 found a negative relationship between the bank's performance and capitalization ratio. This result can be explained by the fact that the high capital ratio decreases both the risk of the banks and tax subsidy form interest expenses. Overly conservative management might not be taking advantage of certain market opportunities and consequently experiencing lower performance (Saona, 2016). The third line of empirical evidence advocates that there is no relationship between capital adequacy ratio and banks' profitability. A study conducted by Bhattarai in 2016 found an insignificant association capital adequacy ratio and Nepalese banks' profitability. A similar result was found by Dietrich, & Wanzenried in 2014 in low-and-middle countries. This result can be explained by the fact that they did not able to generate more loans and absorb more losses and fail to support the regulator's recapitalization policy.

2.2 Asset quality and bank profitability

Existing literature reveals two contrasting empirical shreds of evidence on the impact of capitalization on the bank's profitability. Asset quality also directly influences the rate of return on assets. (Gup & Kolari, 2012). The quality of assets can be deteriorated due to the high competition within financial institutions. On the one hand, it can be argued that the decreases in assets quality increase the proportion of non-performing assets, possible loan loss provision and monitoring cost of the banks; which leads to a decrease in banks' profitability. So, it can be expected that there is a positive relationship between asset quality and the bank's performance. In other words, there is an inverse relationship exist between provision for loan loss ratio and ROA and NIM. A study conducted by Patria, Capraru & Ihnatov in 2015 entitled 'determinants of banks' profitability: Evidence from EU 27 banking system' and found an inverse and statistically relationship between provision for loan losses to loan ratio and banks profitability. It means that the higher this ratio, the lower the banks' profitability and vice versa. In other words, the quality of the asset directly affects the bank's profitability. A similar result was found by Bhatta in 2015 argued that an increase in loan loss of the bank results in a decline in owners' equity and constrains the lending capacity of the bank which further reduces the amount of loan disbursement. These results can explain the fact that a low-quality ratio produces higher non-performing assets and increases loan loss

provision for protection against default loss; which leads to lower the bank's profitability. On the other hand, it can be argued that there is a positive and statistically significant relationship between LLRGL and ROA and NIM. A study conducted by Trad, Trabelsi, & Goux in 2017 entitled 'Risk and profitability of Islamic banks: A religious or an alternative solution?' and found a positive and statistically significant association between loan loss reserve to gross loan ratio (LLRGL) and ROA and ROE. This result can be explained by the fact that relaxing credit standard increases both loan loss reserves and gross loan of the banks. It also increases the banks' profitability. Basically, it can be expected that there is a positive relationship between asset quality and bank performance. In other words, there is an inverse relationship existing between provision for loan loss ratio and ROA and NIM. Bank asset quality has been responsible for the success or failure of the bank. The best measure for assessing the quality of assets is loan loss provisions to loan ratio. Loan loss provision is the ratio of the loan loss provisions to loans, a measure of the quality of loans granted by banks (Damtsa, Milidonis, & Stathopoulos, 2019). The structure- Conduct-Performance hypothesis posits that a lower competitive loan market will lead to an improvement in profitability for all three different ownership types of Chinese banks (Fang, Lau, Lu, Tan & Zhang, 2019).

2.3 Bank diversification and bank profitability

Existing literature reveals two contrasting empirical pieces of evidence of capitalization on the bank's profitability. Sources of income other than earnings from loans and securities are called simply non-interest income and usually include fees earned from offering trust department services (locker facility), service charges on deposit accounts and miscellaneous fees and charges for other bank services. Recently, bankers have targeted non-interest income or fee income as a key source of future revenues. By more aggressively selling services other than loans such as security brokerage, insurance, and trust services bankers have found a promising channel for boosting the bottom line on their income statement, for diversifying their income sources and for insulating their banks more adequately from the fluctuation of interest rate (Rose, 2002). A study performed by Tan in 2016 and found a significant and negative impact of diversification on bank profitability (NIM). It suggests that the higher level of diversified business precedes a decline in bank profitability. This result can be explained by the fact that a larger variety of businesses engaged by banks reduces the volume of funds available for traditional loan business, which precedes a decline in NIM (Tan, 2016). NIM concentrates on interest-generating activities only. While the banks engaging in the non-interest generating businesses reduces the volumes of traditional loan business, which further proceeds a decrease in NIM of commercial banks (Fang, Lau, Lu, Tan & Zhang, 2019). The results show that banks with low-asset-quality tend to generate more profits by having more non-interest sources of income. His study showed that public and private banks earn higher profits by shifting toward non-interest sources of income from the traditional interest-based income. Over the last decade asset quality of Indian banks has deteriorated continuously. Therefore, to offset the loss of traditional interest-based income, many banks have started providing interest-based, commission, and trading based activities for higher revenue (Ahmad, 2017). The fierce competition between financial institutions will bring excessive credit risk, but the regulatory body (Nepal Rastra Bank) basically discourages banks to do it. So, by generating non-income, banks can recover the loss of poor quality loans and advances. Even though, greater market powers (low competition) within the financial institutions have lower credit risk and earn more non-interest income from diversification. The greater market power might help the banks to select good customers, provides revenue growth opportunities from fee-based and commission-based new services products and enhances bargaining power to contract creation (Ovi, Peresa, & Colombage, 2014). A study conducted by Ovi, Peresa, & Colombage, in 2014 found a positive and statistically significant association between market power and non-interest income. The findings of this study can be explained by the fact that greater market power (low competition) in loans and deposit markets gives ground for growth opportunities in non-traditional income from fees and commission-based products. Income diversification has a positive impact on bank profitability in high-income and middle-income countries, but not in low-income countries. This result can be explained by the fact that margins in the traditional retail banking business are much higher for banks in low-income countries compared to banks in high-income countries; therefore income diversification in low-income countries is not beneficial because profit margin from interest income is higher than margins from fee, commission, and trading operations (Dietrich & Wanzenried, 2014).

2.4 Operating efficiency and bank profitability

Existing literature reveals two contrasting empirical pieces of evidence of capitalization on bank profitability. Operating efficiency deals with the production of outputs such as deposit and loan accounts and at a minimum cost per dollar (or account) (Gup & Kolari, 2012). Overhead cost is highly significant and positively related to bank profitability with regards to ROE, NIM, and PBT. This finding can be explained by the fact that large volume of operating expenses is derived from paying salaries and wages to staff, while higher levels of salaries and wages paid to staff significantly improve the staff productivity, while the resulting improvement in the bank profitability is much larger than the salaries and wages paid out by the bank (Tan, 2016). He found a positive relationship between operating efficiency and ROA, ROE, NIM, and PBT. Cost efficiency is found to be significantly and positively related to bank profitability, indicating that Chinese commercial banks with a higher level of cost efficiency have higher profitability (Fang, Lau, Lu, Tan & Zhang, 2019). Higher values of this variable indicate there is a higher volume of cost and further indicates that the bank does not control and manage the cost very well. On the one hand, higher volumes of operating costs without any doubt will have a negative impact on bank profitability. This argument is supported by the finding of Athanasoglou et.al. (2008) with regard to the Greek banking industry. On the other hand, this operating cost may possibly come from higher salaries and wages, and according to efficiency theory, the higher level of salary will significantly promote staff productivity, and further promote the bank's profitability (Tan, 2017).

Table 1: Description of the variables and their expected impact on bank profitability

Variables	Measurement	Expected effect
Profitability	ROA	
Capitalization	Capital adequacy ratio	-
Asset quality	Provision for the loan loss ratio	-
Operating efficiency	Cost to income ratio	-
Bank diversification	Non-interest income to gross income ratio	+

3. Variables Selection and Research Methods

3.1 Variable selection

3.1.1 Dependent variable: The main purpose of the study is to explain the impact of bank-specific variables on profitability. This study considers the mere one variable ROA as the dependent variable. This is measured by dividing net income by total assets of the bank. It is a widely used tool to measure the banks' performance.

3.1.1 The bank-specific variables: In this current study, four predictor variables are used. The first independent variable capital is measured by the capital adequacy ratio. A higher capital ratio indicates that the bank has lower risk. The second independent variable assets quality variable is measured by loan loss provision to the gross loan ratio. A higher ratio indicates poor asset quality. The third independent variable operating efficiency is measured by the total operating cost to the total operating revenue ratio. A higher ratio indicates that the bank is less efficient. Finally, the fourth independent variable diversification is measured by non-interest income to total gross income ratio. A high ratio indicates that the bank is highly diversified.

3.2 Research methods

Now 28 commercial banks are operating in Nepal. So, 28 commercial banks are considered as population. Among them, only eight commercial banks are taken as a sample by using non-probability convenience sampling. The study period was 2002/03 to 2016/17. This empirical study is based on time series panel data which is gathered through the review of quarterly and annual reports of the Nepal Rastra Bank and Ministry of Finance of Nepal. The collected time series data are analyzed using descriptive statistics, Pearson correlation coefficient, and multiple regression model. Therefore, this research employed a descriptive and explanatory research design. The average value, standard deviation, maximum, and minimum value are used to describe the characteristics of data from 2002/03 to 2016/17. The correlation matrix is used to examine the relationship between a response variable and predictor variables. The correlation matrix helps to identify the multicollinearity

problem. A common rule of thumb is that correlations among the independent variables between -0.7 to 0.7 do not cause difficulties (Lind, Marchal, & Wathen, 2006). Some statisticians assume that the correlation coefficient between predictor variables between -0.9 to 0.9 does not harm significantly. Thus, in this research, the researcher accepts those independent variables whose correlation coefficient lies between -0.9 to 0.9. Multicollinearity problem is detected based on VIF if VIF is greater than five (Titko, Skvarciany, & Jureviciene, 2015). Finally, the collected data are analyzed by using the Statistical Package for Social Sciences (SPSS).

Multiple regression models

Based on the review of the literature, to examine the relationship between the dependent variable and independent variables, the following multiple regression model has been tested.

$$ROA = a + \beta_1 (CAR) + \beta_2 (AQ) + \beta_3 (OE) + \beta_4 (D) + \epsilon_{ij}$$

Where ROA= Return on Assets, CAR= Capital Adequacy Ratio,

AQ = Assets Quality, OE = Operating efficiency, D= Diversification

4. Empirical Results and Discussions

Table 2 shows the descriptive statistics of dependent and independent variables. Table 3 shows the correlation matrix of response and predictor variables. This study mainly focuses on regression results. Table 3 shows the results of regression analysis. The regression coefficient of assets quality ($\beta = -1.64$, $p < .01$) indicates that a higher loan loss provision to the gross loan ratio result in the lower ROA to the banks. This result is similar to the expected results which are presented in table 1. This result is in line with the findings of Patria, Capraru & Itnatov (2015), however, it is in contrast with the findings of Trad, Trabelsi, & Goux (2017). The result of this regression coefficient can be explained by the fact that low-quality assets (higher loan loss to gross loan ratio) produce higher non-performing assets; increase loan loss provision for protection against default loss which eventually leads to lower the bank's profitability. Even though the loss from the relaxation of credit standard can be compensated by charging higher interest rates, the Nepalese commercial banks should supervise, and monitor the borrowers' position after granting the loan to the borrower in order to decrease non-performing assets.

Table 2: Descriptive statistics of response and predictors variables

Variables	N	Minimum	Maximum	Mean	SD
Asset Quality	96	.01	34.08	1.87	5.02
Diversification	96	-2.54	51.53	2.40	6.90
Capital Adequacy Ratio	96	-55.44	21.08	5.04	15.97
Operating Efficiency Ratio	96	0.40	2.79	1.92	3.19
ROA	96	-15.35	18.04	3.52	.917

Table 3: Correlation matrix of response and predictor variables

Variables	1	2	3	4	5
ROA	1	-.607* (.000)	.064 (.535)	.138 (.018)	-.689* (.000)
Asset Quality	-.607* (.000)	1	-.0039 (.708)	-.442* (.000)	.733* (.000)
Diversification	.064 (.535)	-.039 (.708)	1	.005 (.963)	.049 (.637)
Capital Adequacy Ratio	.138 (.018)	-.442* (.000)	.005 (.963)	1	-.493** (.000)
Operating Efficiency	-.689* (.000)	.732* (.000)	.049 (.637)	-.493* (.000)	1

Note. *Correlation is significant at the 0.01 level (2-tailed)

Table 4: Multiple regressions ROA on all predictor variables

Variables	Coefficient	t-statistics	P-value	VIF
Intercept	7.571	9.278	.000	

Asset Quality	-1.64**	-2.523	.013	2.224
Diversification	.04	1.259	0.211	1.015
Capital Adequacy Ratio	-.059*	-3.724	.000	1.346
Operating Efficiency	-7.001*	-6.144	.000	2.367
R	.755			
R ²	.570			
F	30.101*			
P-value	.000			

Note. *Correlation is significant at the 0.01 level (2-tailed), **Correlation is significant at the 0.05 level (2-tailed),

The regression coefficient of diversification ($\beta = -.04$, $p > .05$) indicates that there is an insignificant relationship between asset diversification and bank profitability. It reveals that assets diversify from traditional loan business to non-traditional business do not increase bank's profit significantly even though these two variables are positively correlated. This result is similar to the expected results which are presented in table 1. This result is in line with the findings of Tan (2016), Fang, Lau, Lu, Tan & Zhang (2019), however, it is in contrast with the findings of Ahamed (2018), Ovi, Peresa, & Colombage (2014), and Ditrich & Wanzenried (2014). This result can be explained by the fact that fee-based income and other service charges generated by the banks are too low which does not impact significantly on the bank's profitability. The regression coefficient of capital adequacy ($\beta = -.059$, $p < .01$) indicates that a higher capital adequacy ratio provides the lower ROA to the banks. This result is similar to the expected results which are presented in table 1. This result is in line with the findings of Patria, Capraru & Ilnatov (2015), and Bhattarai (2016); however, it is in contrast with the findings of Tan (2016), Trad, Trabelsi &, Goux (2017), and Ahemed (2017). The result of the study can be explained by the fact that a higher capital ratio reduces bank risk and reduces the benefit of leverage. The regression coefficient of operating efficiency (the cost to income ratio) reduces bank profitability. This result is similar to the expected results which are presented in table 1. This result is in line with the findings of Tan (2016), and Athanasoglou et.al. (2008); however, it is in contrast with the findings of Tan (2016). This result can be explained by the fact that a higher volume of operating costs reduces the bank's profitability because profit is the difference between total revenue and total cost and further it indicates that the banks are not able to control and manage cost properly.

5. Conclusion, Implication, and Limitations of the Study

Basically, bank-specific variables and microeconomic variables affect the banks' profitability. The empirical studies conducted by various researchers reveal the contradictory results that affect banks' performance. In this study, four independent variables are taken to gauge the impact of these variables on banks' profitability. This study employs ordinary least squares regression models to gauge the relationship between response and predictor variables. The model is statistically significant ($F = 30.101, < .01$) suggest that the independent variables such as assets quality, operating efficiency, and capital adequacy ratio significantly affect bank profitability. But one predictor variable named diversification does not affect banks' profitability significantly.

Nepal is a low-income country. The Nepalese banking sector is not well developed still now. This study certainly helps the banker and policymaker to take effective action in order to improve banks' profitability and stability. This study covers only four variables, therefore, further research needs to be done by including more variables including macroeconomic variables.

References

- Ahamed, M. M. (2017). Asset quality, non-interest income, and bank profitability: Evidence from Indian banks. *Economic Modeling*, 63, 1-14. <http://dx.doi.org.10.1016/j.ecomod.2017.01.016>
- Bhatta, G. (2015). Theoretical paradigm on bank capital regulation and its impact on bank-borrower behavior. *Economic Review*, 27(2), 19-34. Retrieved from https://www.nrb.org.np/ecorev/articles/Vol27-2-art2.Theoretical_Paradigm_Final.pdf
- Bhattarai, Y. R. (2016). Effects of credit risk on the performance of Nepalese commercial banks. *Economic Review*, 28(1), 41-64. https://www.nrb.org.np/ecorev/articles/vol28-1_art3.pdf

- Bhetuwal, K. R. (2007). Financial liberalization and financial development in Nepal. *Economic Review*, 16, 23-41. Retrieved from https://www.nrb.org.np/ecorev/pdffiles/vol19_art3.pdf
- Curak, M., Poposki, K., & Pepur, S. (2012). Profitability determinants of the Macedonian banking sector in changing environment. *Procedia- Social and Behavioral Sciences*, 44, 406-416. Doi.10.1016/j.sbspro.2012.05.045
- Damtsa, S. M., Milidonis, A. & Stathopoulos, K. (2019). National culture and bank risk-taking. *Journal of Financial Stability*, 40, 132-143. <http://dx.doi.org.10.1016/j.jfs.2017.08.007>
- Dietrich, A. & Wanzenried, G. (2014). The determinants of commercial banking profitability in low-, middle-, and high-income countries. *The Quarterly Review of Economics and Finance*, 54, 337-354. <http://dx.doi.org.10.1016/j.qref.2014.03.001>
- Fang, J., Lau, C. M., Lu, Z., Tan, Y., & Zhang, H. (2019). Bank performance in China: A perspective from bank efficiency, risk taking and market competition. *Pacific- Basin Finance Journal*, 56, 290-309. <http://dx.doi.org.10.1016/j.pacfin.2019.06.011>
- Gup, B. E. & Kolari, J. W. (2012). *Commercial banking: The management of Risk*. New Delhi: Willey India (p) Ltd.
- Kharel, R. S. & Pokharel, D. R. (2012). Does Nepal's financial structure matter for economic growth? *Economic Review*, 24 (2), 31-46. Retrieved from https://www.nrb.org.np/ecorev/pdffiles/vol24-2_art3.pdf
- Lind, D. A. , Marchal, W. G., and Wathen, S. A. (2006). *Basic statistics for business and statistics*. New York: McGraw Hill.
- Neupane, B. P. (2015). Role of financial development in economic growth in Nepal. *Economic Review*, 27(1), 1-16. Retrieved from <https://www.nrb.org.np/ecorev/index.php?vid=27-1>
- Ovi, N. Z., Perera, S., & Colombage, S. (2014). Market power, credit risk, revenue diversification, and bank stability in selected ASEAN countries. *South East Asia Research*, 22 (3), 399-416. Retrieved from www.jstor.org/stable/43818537
- Petria, N., Capraru, B., & Ilnatov, I. (2015). Determinants of banks profitability: Evidence from EU 27 banking systems. *Procedia Economics and Finance*, 20, 518-524. Doi.org.10.1016/S2212-5671(15)00104-5
- Pouroush, J., & Schreiber, B. Z. (2019). Profitability, capital, and risk in US commercial and saving banks: Re-examination of estimation methods. *The Quarterly Review of Economics and Finance*. <http://dx.doi.org.10.1016/j.qref.2018.12.007>
- Rose, P. S. (2002). *Commercial bank management*. New York: McGrawHill Companies.
- Saona, P. (2016). Intra-and extra-bank determinants of Latin American Banks' profitability. *International Review of Economics and Finance*, 45, 197-214. <http://dx.doi.org.10.1016/j.iref.2016.06.004>
- Shrestha, G. K. (2004). Financial sector reforms in Nepal. *Economic Review*, 16, 75-90. Retrieved from https://www.nrb.org.np/ecorev/pdffiles/vol16_art3.pdf
- Sufian, F., & Kamarudhin, F. (2012). Bank-specific and macroeconomic determinants of profitability of Bangladesh's commercial banks. *The Bangladesh Development Studies*, 35 (4), 1-28. Retrieved from www.jstor.org/stable/41968840
- Tan, Y. (2016). The impact of risk and competition on bank profitability in China. *Journal of International Financial Markets, Institution & Money*, 40, 85-110. <http://dx.doi.org.10.1016/j.intfin.2015.09.003>
- Tan, Y. (2017). The impact of competition and shadow banking on profitability: Evidence from the Chinese banking industry. *North American Journal of Economics and Finance*, 42, 89-106. <http://dx.doi.org.10.1016/j.najef.2017.07.007>
- Tan, y., & Floros, C. (2014). Risk, profitability, and competition: Evidence from the Chinese banking industry. *The Journal of Developing Areas*, 48(3), 303-319. Retrieved from www.jstor.org/stable/24241240
- Tiko, j., Skvarciany, V., & Jureviciene, D. (2015). Drivers of bank profitability: Case of Latvia and Lithuania. *Intellectual Economics*, 9, 120-129. <http://dx.doi.org.10.1016/j.intele.2016.02.003>
- Trad, N., Trabelsi, M. A., & Goux, J. F. (2017). Risk and profitability of Islamic banks: A religious or an alternative solution?. *European Research on Management and Business Economics*, 23, 40-45. <http://dx.doi.org.10.1016/j.iedeen.2016.09.001>



An Integrated Model for Career Preferences of the Graduates in Bangladesh

Taskina Ali¹

¹ Assistant Professor, School of Business & Economics, United International University. taskina.ali@gmail.com.
Contact: 88-01715040592

Abstract

Career selection is one of the most crucial decision made by potential incumbents and graduates in the business world. This decision is generally influenced by the factors like internal (cognitive ability, emotional ability, psychomotor skills) and external environmental (socio-economic condition, academic orientation, motivational factors, urban-rural background, etc.). Little studies have been done on the employment market, job situations, the process and the factors affecting career preferences of business graduates in Bangladesh. The proposed study aims at gaining a better understanding about the career preferences of business graduates in our country. It also intends to identify and analyze the determinants of career choices and find out the relevant major determinants with particular focus on the private and public sectors of Bangladesh. More specifically the study will focus on whether career preferences by the business graduates of Bangladesh are dependent on their family income level, gender, age, educational background, geographical location, individual cognitive ability, emotional intelligence, ethics, values, types of organization and employer's characteristics. It is further intended to focus on the pattern of variation in career preferences by the business graduates vary due to educational institutional orientation. The study is exploratory in nature. The extensive literature review suggests that, the career preferences of graduates are influenced by their family orientation, educational level, emotional attachment, cognitive ability, organization's reputation, age, gender.

Keywords: Career, Career Preferences, Business Graduates, Recruitment, Employer Characteristics

1. Background

There have been good amount of theories and researches on the expectations and preferences of graduates towards their career preferences in different countries. Extensive literatures show that gender differences, age, cognitive ability, family background, educational orientation have direct effect on graduates to select their career. But more needs to be discovered whether Bangladeshi business graduates are influenced by the same factors. Graduates' profile, context, internal and external orientation of graduates, curriculum, teaching methods, style are different in different countries. Thus it is required to focus on the graduates of Bangladesh to reveal their determinants in career preferences. Career choice is such a major decision which shapes the entire professional path of graduates. Moreover, this career selection also defines the future life pattern, work-life balance, social and economic status, job satisfaction, self- actualization of any graduates. This crucial decision is not easy to make and it is not a simple

task rather without proper guidance, clear perception, professional counselling graduates may select the wrong career. In choosing career, graduates should know their self-interests, passion, basic abilities, their personal surroundings and deficiencies also. This research seeks to provide an insight on Bangladeshi business graduates' career preferences and identifying the major determinants which influences graduates' career preferences in Bangladesh. As every year more and more graduates are joining the job market of Bangladesh so this area should be highlighted and thus employer as well as potential job seekers, graduates will also be beneficial.

2. Literature Review

The word "career" is from French and Latin origin. Geciki (2002) simply defined career as; the occupational, commercial or industrial activity that a person may adopt during his educational life or in some other part or till his death. Redman and Wilkinson (2001) termed career as a process of application of one's cognitive ability, contribution to a profession over a long time and better building better business network. Adaptability, emotional intelligence, cognitive ability and other competencies have positive impact on graduates' career preferences and career success also (Amdurer, E., Boyatzis, R.E., Saatcioglu, A., Smith, M.L. and Taylor, S.N., 2014).

With increasing globalization process and the increasing number of regional trading blocs, doors are opening for business graduates to seek employment in different local, international organizations inside the home country as well as different parts of the world. In spite of the fact of global downsizing and prevailing high unemployment rate (4.2%) in Bangladesh, local business graduates are becoming quite choosy about their career offers. As more organizations are trying to find out the most talented incumbents for the vacant and newly created posts in their respective organizations, thus there is always a very competitive situation in the job market. Attracting or recruiting the right graduates for the business organization is more crucial than previous time. Graduates' emotional intelligence, communication skills, adaptation power directly influence them to choose career (Ketter, 2011). Interestingly, business graduates in Bangladesh are highly influenced by their socio-economic condition, educational background, cultural orientation (M. Rahman, 1987). Worldwide business graduates are largely affected by the job attributes like job descriptions, work environment, compensation and security packages offered by the organizations (Moy & Lee, 2002). Ngesi (2003) in his study stated that, graduates from poor socio-economic background chose those career where less trainings are required and duration of training is also short. Financial conditions of the family, social class, affordability and employability in a particular industry further influence the graduates to select their career choices (Ahmed, Sharif & Ahmad, 2017). Several studies also found that career preferences are determined by various motives and the most important motive influencing the career decision are financial success and high income (Carter, 2003), need of autonomy and independence (Van Auken, Stephens, Fry, and Silva, 2006), social recognition and status (Birley and Westhead, 1994). These aspiring young business graduates sometimes also strongly influenced by family member's decisions (Ajzen, 1991). Brown (2002) identified family members or friends' influence greatly impact the career decision-making process and the specific career path graduates opt for. As career selection is not only a challenge but also a great dilemma for the graduates, thus skills, life conditions, academic achievements are playing major role to choose right career (Ferry, 2006).

To serve the rapid expanding and new changing economy of Bangladesh, organizations are desperate to attract and retain skilled, motivated and of course diversified work force in their work premises (Morrison & Von Glinow, 1990). As business organizations are expanding in rapid rate and thus business graduates' services are required more than earlier, organization should address these graduates' preferences, expectations, and experiences. In addition, downsizing, rightsizing, horizontal structure of the organization, these factors also influence all major stakeholders towards career preferences (Fallows and Steven, 2000).

In some cases it is evident that gender is playing major role while selecting career by the business graduates (Browne 1997). In recent time, once again graduates' gender is a determinant in selecting career path (Konard, Ritchie, Lied & Corrigan 2000). Some of the researchers have exclusively focused on specific attributes, such as pay preferences (Cable & Judges 1994), and specific individual differences, like gender (Tolbert & Moen, 1998). Interestingly it is observed that higher financial benefits attracts men to accept job offer where women are influenced by social security, values, utility (Sax, 1994).

There has been a large amount of theory on how people decide which job offer to accept. One comprehensive and dynamic career theory that combines many aspects of career development is the Social Cognitive Career Theory (SSCT). The SCCT was derived from Bandura's (1977, 1986, 1997) Social Cognitive Theory, which emphasized the importance of self-efficacy in one's choice of behaviour. According to Bandura (1986), individuals choose to accept any job offer based on their self-judgment about the qualifications required to accomplishing the task. Another theory "A Social Learning Theory of Career Selection" (Krumboltz, Mitchel & Brain, 1976) identified the impact of race, gender, physical appearances, intelligence, macular coordination and nature of job opportunity in choosing career by the business graduates. In many cases it has been observed graduates accept or reject career options based on their personal strengths and weaknesses (E. Hossain & T. Siddique, 2012).

It is also observed that cultural values, individual abilities, dominance of family members have greater impact on career preferences of graduates (Tanuja Agarwala, 2008). But at the same time there are situations also when graduates accept the available job offer without waiting further for the cherished career (Alan M Saks, Blake E. Ashforth; March 1998). According to Donald P. Schwab (1982) in job market potential as well as existing job seekers consider three factors when evaluating job offer and these are objective factors (pay, location, opportunity of advancement), subjective factors (match of person's personality, perception with organization's value, image) and recruiting factors (politeness, status, competency of recruiter).

At present in Bangladesh the fastest growing sectors are the financial, information technology and telecommunication where most business graduates are getting jobs and at the same time graduates also prefer these industries (Khaled Shams Chishty, Munir Uddin and kumar ghosh, 2007). Again, these business graduates consider their major academic orientation, gender, and personality to determine whether to join local organizations or MNCs (Huang & Sverke, 2007). Previous researches on the relationship between higher education and employment clearly demonstrated that the subjects graduates studied in the undergraduate level highly influence their career choices (Purcell, Elias and Davies, & Wilton, 2005). For the past few decades, many researchers have investigated various factors that influence job selection decisions. Several of them focused on preferences for certain categories of students such as accounting students (Bundy & Norris 1991, Rebele, Apostolou, Buckless, Hassel, Paquette & Stout, 1998, Rebele, Stout & Hassell 1991) and information systems students (Robbins 1996). Others have looked for differences between perceptions of students before and after a decision on a job offer (Turban, Eyring & Campion 1993), between students and recruiters (Butler et. al 2000, Kirsch, Leathers & Snead 1993), and between students and working professionals (Carcello, Copeland, Hermanson & Turner 1991).

Number of researchers have looked at various sets of factors important to individuals in evaluating jobs. Some have attempted to categorize these factors in various ways, including job and organization characteristics (Barber & Roehling, 1993; Feldman & Arnold, 1978); employment process categories (Barber & Roehling, 1993); work values (Judge & Bretz, 1992); motivation and hygiene factors (Misra & Karlo, 1972); factors intrinsic and extrinsic to the job (O'Reilly & Caldwell, 1980); existence, relatedness, growth factors (Shamir & Arthur, 1989); recruiter characteristics and evaluative issues (Rynes, 1900; Rynes, Heneman, & Schwab, 1980; Rynes & Miller, 1983). Importance and recognition of job, organizational attractiveness and diversity, characteristics of recruiter's greatly attract business graduates towards the organization and their preferred career (Thomas, 1999). On the basis of above analysis this study developed an integrated model for career preferences of Bangladeshi graduates which are shown in Fig-1.

3.3. A Conceptual Framework

Based on the literature reviews it has become an established fact that career preferences is quite influenced by the social status, living cost, family background, educational background, years of schooling, self-actualization, individual cognitive ability, emotional intelligence, personality, socio-economic background. Based on these factors a conceptual model has been developed to show the relationship among afore said variables and the career preferences. This model describes the relationships among various factors (internal factors like-cognitive ability, values, ethics, socio-economic, motivational, and employer's characteristics). This model also identifies the variables which may influence the various factors and thus giving a new dimension for graduates' career preferences in Bangladesh.

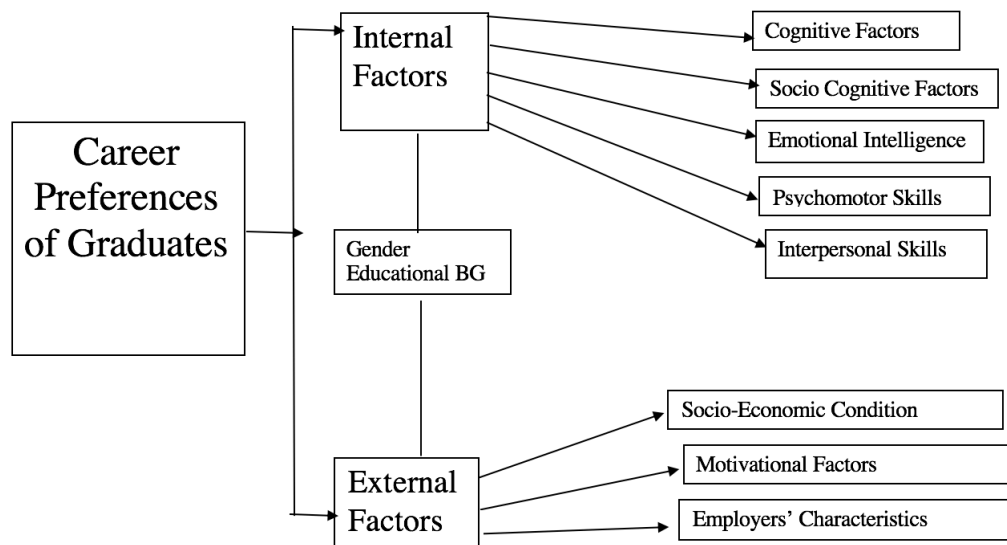

Fig: A Conceptual Framework of Career Preferences of Graduates in Bangladesh

5. Conclusion

Based on the substantial literature review it is visible that, age, gender, economic condition, family background, social status, emotional feelings, attitude of graduates, these variables have strong effect on career preferences of graduates worldwide. The developed conceptual framework also suggested that these variables also substantially influence the graduates of Bangladesh. The recruiters and both local, multinational private and public organizations can consider these variables while recruiting the graduates and thus make an effective recruitment decision.

References

- Agarwala, T., 2008. Factors influencing career choice of management students in India. *Career Development International*, 13(4), pp.362-376.
- Ahmed, K.A., Sharif, N. and Ahmad, N., 2017. Factors influencing students' career choices: empirical evidence from business students. *Journal of Southeast Asian Research*, pp.1-15.
- Ajzen, I., 1991. The theory of planned behavior. *Organizational behavior and human decision processes*, 50(2), pp.179-211.
- Amdurer, E., Boyatzis, R.E., Saatcioglu, A., Smith, M.L. and Taylor, S.N., 2014. Long term impact of emotional, social and cognitive intelligence competencies and GMAT on career and life satisfaction and career success. *Frontiers in Psychology*, 5, p.1447.
- Bandura, A., 1986. Social foundations of thought and action. *Englewood Cliffs, NJ*, 1986.
- Barber, A.E. and Roehling, M.V., 1993. Job postings and the decision to interview: A verbal protocol analysis. *Journal of Applied Psychology*, 78(5), p.845.
- Birley, S. and Westhead, P., 1994. A taxonomy of business start-up reasons and their impact on firm growth and size. *Journal of business venturing*, 9(1), pp.7-31.
- Brown, D., 2002. The role of work and cultural values in occupational choice, satisfaction, and success: A theoretical statement. *Journal of counseling & development*, 80(1), pp.48-56.
- Browne, B.A., 1997. Gender and preferences for job attributes: A cross cultural comparison. *Sex Roles*, 37(1-2), pp.61-71.
- Bundy, P. and Norris, D., 1992. What accounting students consider important in the job selection process. *Journal of Applied Business Research*, 8(2), pp.1-6.
- Carter, N.M., Gartner, W.B., Shaver, K.G. and Gatewood, E.J., 2003. The career reasons of nascent entrepreneurs. *Journal of Business Venturing*, 18(1), pp.13-39.

- Cable, D.M. and Judge, T.A., 1994. Pay preferences and job search decisions: A person-organization fit perspective. *Personnel psychology*, 47(2), pp.317-348.
- Carcello, J.V., Copeland Jr, J.E., Hermanson, R.H. and Turner, D.H., 1991. A public accounting career: The gap between student expectations and accounting staff experiences. *Accounting Horizons*, 5(3), p.1.
- Elias, P. and Purcell, K., 2004. Is mass higher education working? Evidence from the labour market experiences of recent graduates. *National Institute Economic Review*, 190(1), pp.60-74.
- Fallows, S. and Steven, C., 2000. Building employability skills into the higher education curriculum: a university-wide initiative. *Education+ training*, 42(2), pp.75-83.
- Ferry, N.M., 2006. Factors influencing career choices of adolescents and young adults in rural Pennsylvania. *Journal of Extension*, 44(3), pp.1-6.
- Geçikli, F., 2002. BİREYSEL KARIYER PLANLAMA VE GELİŞTİRMEDE İMAJIN ROLÜ. *İstanbul Üniversitesi İletişim Fakültesi Dergisi\ Istanbul University Faculty of Communication Journal*, (15).
- Herrnstein, R. J. & Murray, C.(1994) *The Bell curve: Intelligence and class structure in American life*. New York: The Free Press.
- Hossain, M.E. and Siddique, T., 2015. Career Preference of Business Graduate in Bangladesh: A Case Study of Some Selected Private Universities. *Asian Business Review*, 1(2), pp.106-113.
- Huang, Q. and Sverke, M., 2007. Women's occupational career patterns over 27 years: Relations to family of origin, life careers, and wellness. *Journal of vocational behavior*, 70(2), pp.369-397.
- Johnston, W.B., & Packer, A.H.(1987) *Workforce2000: Work and workers for the 21st century*. Indianapolis: Hudson Institute.
- Judge, T.A. and Bretz, R.D., 1992. Effects of work values on job choice decisions. *Journal of applied psychology*, 77(3), p.261.
- Ketter, P., 2011. Soft skills are must-haves in future workplace. *T&D*, 65(9), pp.10-10.
- K.K. Chisty, G. Munir Uddin & S.K. Ghosh (2007). The Business Graduates Employability in Bangladesh: Dilemma and Expected Skills by Corporate World. *Brac University Journal*, Vol.IV, No:1. PP:1-8.
- Kirsch, R.J., Leathers, P.E. and Snead, K.C., 1993. Student versus recruiter perceptions of the importance of staff auditor performance variables. *Accounting Horizons*, 7(4), p.58.
- Konrad, A.M., Ritchie Jr, J.E., Lieb, P. and Corrigan, E., 2000. Sex differences and similarities in job attribute preferences: a meta-analysis. *Psychological bulletin*, 126(4), p.593.
- Krumboltz, J. D., Mitchell, A. M. and Brian Jones, G. (1976) 'A Social Learning Theory of Career Selection', *The Counseling Psychologist*, 6(1), pp. 71–81. doi: 10.1177/001100007600600117.
- Misra, S. and Kalro, A., 1972. Simulated organizational choice: Post decision dissonance reduction and self-perception. *Journal of Applied Psychology*, 56(6), p.461.
- Morrison, A.M. and Von Glinow, M.A., 1990. *Women and minorities in management* (Vol. 45, No. 2, p. 200). American Psychological Association.
- M. Rahman.(1987) *Career Preferences and Employment profile Among Graduating and Graduate MBAs of IBA, Dhaka University*. *Journal of Business Administration*, Vol. 13, No.2, p-143.
- Moy, J.W. and Lee, S.M., 2002. The career choice of business graduates: SMEs or MNCs? *Career Development International*, 7(6), pp.339-347.
- Ngesi MJ 2003. *A Study Of Systematic Processes Influencing Educational Change in a Sample of IsiZulu Medium Schools*. Ph.D Thesis, Unpublished. Pietermaritzburg, University of Natal.
- O'reilly, C.A. and Caldwell, D.F., 1980. Job choice: The impact of intrinsic and extrinsic factors on subsequent satisfaction and commitment. *Journal of Applied Psychology*, 65(5), p.559.
- Rebele, J.E., Apostolou, B.A., Buckless, F.A., Hassell, J.M., Paquette, L.R. and Stout, D.E., 1998. Accounting education literature review (1991–1997), part II: students, educational technology, assessment and faculty issues1. *Journal of Accounting Education*, 16(2), pp.179-245.
- Redman, T.&Wilkinson, A., 2001.*Contemporary Human Resources Management*, NewYork: Financial Times , Prentice Hall.
- Robbins, R.R., 1996. Attitudes and Perceptions of Computer Information Systems students toward Employment Opportunities. *Journal of employment counseling*, 33(2), pp.61-69.
- Rynes, S.L., 1989. Recruitment, job choice, and post-hire consequences: A call for new research directions.
- Rynes, S.L., Schwab, D.P. and Heneman III, H.G., 1983. The role of pay and market pay variability in job application decisions. *Organizational Behavior and Human Performance*, 31(3), pp.353-364.
- Sax, L.J., 1994. Retaining tomorrow's scientists: Exploring the factors that keep male and female college students interested in science careers. *Journal of Women and Minorities in Science and Engineering*, 1(1).
- Saks, A.M. and Ashforth, B.E., 2002. Is job search related to employment quality? It all depends on the fit. *Journal of applied Psychology*, 87(4), p.646.
- Schwab, D.P., 1980. *Recruiting and organizational participation*. Graduate School of Business, University of Wisconsin-Madison.
- Shamir, B. and Arthur, M.B., 1989. An exploratory study of perceived career change and job attitudes among job changers. *Journal of Applied Social Psychology*, 19(9), pp.701-716.

- Thomas, K.M. and Wise, P.G., 1999. Organizational attractiveness and individual differences: Are diverse applicants attracted by different factors?. *Journal of Business and Psychology*, 13(3), pp.375-390.
- Tolbert, P.S. and Moen, P., 1998. Men's and women's definitions of "good" jobs: Similarities and differences by age and across time. *Work and occupations*, 25(2), pp.168-194.
- Turban, D.B., Eyring, A.R. and Campion, J.E., 1993. Job attributes: Preferences compared with reasons given for accepting and rejecting job offers. *Journal of Occupational and Organizational Psychology*, 66(1), pp.71-81.
- Van Auken, H., Stephens, P., Fry, F.L. and Silva, J., 2006. Role model influences on entrepreneurial intentions: A comparison between USA and Mexico. *The International Entrepreneurship and Management Journal*, 2(3), pp.325-336.



The Impact of Effective Training on Employee Retention: A Study in Private Banks of Bangladesh

Shahin Akther¹, Javed Tariq²

¹Faculty Member, Training Institute, Mercantile Bank Limited, Dhaka, Bangladesh, Email:shahustc@gmail.com

²Principal, Training Institute, Mercantile Bank Limited, Dhaka, Bangladesh
Email:javed.tariq@mblbd.com

Abstract

This examination underlines on the affectability of variables influencing employee continuation in Banking Industry of Bangladesh. Retain human resources is a procedure practiced by organizations to keep hold of a successful workforce and simultaneously meet operational necessities. Every organization must regard their work force as prime assets and need not to intend to depart since they enhance the value of the organization. The goal of the investigation is to gauge the view of employee retention. For this purpose, the sample chose 204 employees working in private banks of Bangladesh. We have utilized needed testing technique for credible information accumulation. We have utilized just essential information through an endorsed questionnaire. The gathered information was handled by applying t-test, ANOVA. In this investigation, univariate, bivariate and multivariate examinations were executed. Factor analysis and regression examination have attempted to evaluate the relationship of the factors. The aftereffect of the examination uncovers that employee retention relies upon depends on growth opportunity of the employees, employee self-attainment, Training and Development and employee benefits.

Keywords: Employee Retention, Regression, Factor Analysis, ANOVA, t-test

1. Introduction

Retention of employees is one of the biggest concerns for any organizations. Many renowned organizations are constantly struggling with the 'retention' issues nowadays. Today's ever-changing digitized business practices put many organizations to train its workforce constantly which incurs big spending. Therefore, business entities must retain their trained workforce in order to save money because quick turnover hits the bottom line of company's profit. Besides when an organization constantly trains new employees it is a waste of resources. Studies found that when you replace an employee it cost between 20-200% in terms of salary benefit. Consistency is essential for building a business. Losing trained workers slows down the business continuity. Besides, it becomes difficult to attract talents in a transient workforce. Less turn over enhances employee morale, initiates loyalty for the organizations. From marketing point of view retention improves productivity, builds brand image and keeps customer trust.

Bangladesh's banking sector faces some stumbling blocks in improving its service excellence due to poor show in employee retention. Rapidly changing modes of banking practices compel banks to train and retain their employees

for a much longer period of time. Longer working hours, shorter leave period due to work pressure, lesser leave benefits compare to other sectors poses a threat to retain employees in the banking sector. In order to sustain global competition banking sector of Bangladesh must give a serious look to find factors that causes employee turnover. The paper finds various reasons which effects poor employee retention. Factors like work-life-balance, leave duration, leave benefit are some of the mentionable reasons behind lesser than expected employee retention in banking sector of Bangladesh.

2. Literature Review

Extensive academic literatures can be found on the subject of retention of employees in banks & related organizations. The goal of this study is to investigate major variables mentioned in previous literatures.

At present there are 59 scheduled-banks¹ and 05 non-scheduled bank² in Bangladesh which are supervised and guided by country's central bank under Bangladesh Bank Order 1972 and Bank Company Act, 1991. There also operating 34 Non-Banking Financial Institutions (NBFI) regulated under Financial Institution Act 1993 of central bank. Given much importance to this sector due to its regulatory nature and specialize category employee retention plays a major and vital issue apart from other contingent problems such as scarcity of competent employment, employee turnover, motivation and training & development of employee.

Retention is defined as the capability to hold those employees that an organization wants to keep for a longer period (Johnson, 2000). Many findings on employee retention indicate that the absence of retention strategy is making it difficult for leadership to identify crucial skills that must be retained (Mohlala, Goldman and Goosen,2012). Employee retention is a key factor in an organization's success (Lyria, Namusonge and Karanja, 2017). Retention of skilled employees has been of serious concern to managers in the face of ever-increasing high rate of employee turnover. Employees are the most valuable resource in any organization for that matter; special treatment is required to retain them in order to help in achieving organizational performance strategies (Ritter, 2011).

Employees are less likely to leave when they share similar values as their organizations, HRM practices can be used strategically to improve the employee-organization value fit to improve retention (Presbitero, Roxas, and Chadee, 2016). The retention of employees can be further increased through job specific training, career development chances, friendly work environment and rewards with other benefits that should be planned by the organization (Setia and Singh,2014). According to Mwangi and Omondi (2016), creating an amicable and conducive working environment, makes the employees to work and stay in the organization. Work engagement and rewards (Karatepe ,2013), work-life balance (Mwangi and Omondi, 2016), promotion policy have a big role in increasing job satisfaction, which may secure employee retention in banking sector.

Banks are investing immensely in recruiting and developing their employees. The organization is completely at a loss when the employees leave their job once they are fully trained, developed and more so when they already have the experience of operations in the organization thus employee retention should take into account the various measures so that an individual stay in an organization for the maximum period of time (Sinha and Shukla, 2013). HR managers try to prevent the employee turnover by implementing effective retention strategies (James and Mathew, 2012). An integrated HR strategy combining resource and control-based HR practices could also improve retention (Davidson, 2010). These variables consist of training/learning, career development, reward, recognition, attractive salary deal, and job security. Nevertheless, the magnitude of other variables should not be less valued when making plan for retention policy. The levers of retention being used by them are: special training programs, talent pool programs, on boarding of new recruits, job rotation, comfortable postings, incentives, and fast-track promotions. Whereas Carl, Bjorkman, & Pavlovskaya, (1999) highlighted that now the HRM practice to focus an individual is the proactive approach by the management and also became a competitive advantage for the business

¹Schedule Banks are referred to those banks that remain in the list of banks maintained under the Bangladesh Bank Order, 1972.

²Non Scheduled banks which are established for special and definite objectives and operate under any act but are not Scheduled Banks. These banks cannot perform all functions of scheduled banks.

in the last decade. Newly researches find out the relationship of HRM practices with organizational performance, organizational strategies and organizational retention, which are the three different aspects.

In Bangladesh, some determinants of bank employees' retention have been identified such as unattractive pay packages, lack of training and development, partiality and lack of career development, long working hours, lack of job security (Tanchi, 2015).

Banks in Bangladesh are now aware of the bottom-line effect on retaining the quality of employees and central bank (Bangladesh Bank) puts its emphasis on employee retention policy through training. Banks should mold their policies in accordance to employee training and development, which will help banking sector to retain employees for longer time (Salman, Ahmad and Matin, 2014).

When the employees find job satisfaction, they hardly think of switching present job. Retaining skilled employee quite simply adds to increase productivity and morale, while dropping the associated and related costs of turnover. Employee retention is major vital issue facing corporate leaders as a consequence of the lack of skilled labor, economic growth and employee turnover (Ahmad, Iqbal and Sheeraz 2012). Sandhya, and Kumar (2011) suggested that employee retention can be practiced motivating the employees terms of 'Open Communication' that their opinions matter and that management is 100% interested in their input. Yamamoto (2011) emphasized employee benefits management as a sub-system in human resource management, contributing to employee retention. A number of articles focused on various determinants of employee in various financial and non-financial organizations and service industries such as training, compensation and appraisal (Hong, Hao, Kumar, Ramendran and Kadiresan, 2012), work environment (Duffield, Roche, Blay and Stasa, 2011).

According to Mike (2013), Succession planning should be encouraged in organisation. Role of employees should be cleared. Organization should invest in cross-training, coaching job shadowing, mentoring, and job rotation for employee retention.

3. Research Methodology

3.1 Research Design

The research design is a strategy where we integrate the various tools of the study in a scientific, logical and comprehensive way. Therefore, it constitutes the main script for the collection, management, measurement, and analysis of data (De Vaus, D. A, 2001).

In this study, we tried to investigate the cause and effect relationship between the possible retention influencing factors and employee retention, so it can be referred as causal study as well as quantitative research, because the methods of this study emphasize the statistical, mathematical and numerical analysis of data collected through questionnaires, using computational techniques (Babbie, Earl R, 2010). In addition, as some qualitative phenomenon is adopted in this research, it may be considered as mixed approach. To conduct this research, the cross-sectional method was implemented which implies that data was collected at a single moment in time by the several segments of population that are being sampled (Zikmund et al., 2013).

3.2 Population and Sampling Design

3.2.1 Population

A population is the total aggregation of components from which we collect a sample in order to analysis and make an inference of that total aggregation (Cooper & Schindler, 2014). In this study, the employees of the schedule banks, operated within the geographical area of Bangladesh, are our target population. In Bangladesh, total 59 banks are operating and according to the ownership those are categorized as- (a) State Owned Commercial Banks (6), (b) Islami Shariah based Bank (8) (c) Specialized Banks (3), (d) Private Commercial Banks (33) and (e) Foreign Commercial Banks (9). Since all these banks have their headquarters in one geographical location which

is capital city Dhaka, we decided to collect samples only from Dhaka District by covering as much as the number of banks in a short time.

3.2.2 Sampling Design

3.2.2.1 Sampling Frame

The sampling frame describes a set of components from which we can select a sample of the target population (Michael S, 2004). The rules and procedures by which some elements or components of the population are selected as samples or respondents are referred to the sampling method. In this study, our sampling frame is the complete list of total of 41 banks.

3.2.2.2 Sampling Technique

A sample is a smaller representative group collected from predefined population (Mugenda & Mugenda, 2003), whereas, sampling is the process or technique of selecting a number of individuals or objects from a population such that the selected group represent the maximum characteristics of the entire population (Orodho & Kombo, 2002). In this survey, we have used three stage sampling technique. In first stage we have adopted stratified random sampling technique with proportional allocation, in accordance we have divided the total 57 banks into four several mutually exclusive sub populations or strata according to the ownership of the bank. Secondly, we have used convenient sampling method to choose the bank from each state. In this second stage, we have selected the branches of the banks. In third stage, we have again used the convenient sampling technique to select the employee of the bank as our desired respondent. Convenience sampling is a sampling procedure in which most conveniently available respondents or units are obtained (Zikmund et al., 2013).

3.2.3 Sample Size

A sample size is a representative part of the population chosen for a survey or experiment (Bartlett, J. et al., 2001). We select sample size carefully so that it will be adequate to draw valid and generalized conclusions. We have fixed our sample size with considering that it fulfills the requirement of specific information regarding the problems under investigation in the population under study. (Singh, Ajay S, 2014). In this study, total population is the employees of 41 banks of our country. From these 59 banks we have excluded 6 state-owned commercial banks, 9 foreign commercial banks and 3 specialized banks because the strategies of these banks are different and there are no impact on employee retention in government-services. So, our final population is 41 banks. In any study, 30% sample is suitable to generalize the findings regarding the total population (Mugenda and Mugenda, 2003). In accordance, our study sampled 30% of the population (i.e. approximately 10 banks) proportionately from 41 banks based on their ownership.

The size (n) of sample is determined by following most widely used statistical equation considering that the sample would be 95% likely to measure an estimate with a given level of precision:

$$n = \frac{p(1-p)}{d^2} \times Z^2_{\alpha/2} \times deff$$

The value of the standard normal variate indicates that there is a 100 α % probability of selecting a bad sample. Here,

N= The size of the target population.

P=An a priori proportion.

Z $\alpha/2$ = Z value for α level of significance.

d=The allowable margin of error.

deff= Design effect used for complex survey.

N=Sample size.

The main concern of sample size determination is to make choice of P and d because different range of variable is in under study. We've considered here P=.5 since theoretically this gives the safest sample size as P(1-P) gives the highest value for P=.5. For this sample it is chosen that the value of allowable margin of error, d=.07. Conventionally deff can be taken as 1.5-2.0 in most surveys in Bangladesh which use complex sample such as

multi stage cluster sampling. Because of using stratified sampling instead of multistage sampling it is unnecessary to use large value of deff. So $deff=1$ is chosen here. The conventional choice of α is .05 is considered here which gives $Z_{\alpha/2}=1.96$. Considering all the above, we've got the total sample size, $n=196 \sim 200$. Finally, we collected 204 samples for our study.

Sample size is shown in the following table:

Sl. No.	Bank Name	Sample Size
1	Prime Bank Limited	20
2	Mercantile Bank Limited	24
3	First Security Islami Bank	20
4	Bank Asia Limited	20
5	Pubali Bank Limited	20
6	Uttara Bank Limited	20
7	Mutual Trust Bank Limited	20
8	Al-Arafa Islami Bank Limited	20
9	Premier Bank Limited	20
10	Padma Bank Limited	20
Total		204

3.3 Research Questionnaire

In our study, we used only primary data. To collect data/information we used a prescribed questionnaire as a data collection tool. Our questionnaire has prepared with two main segments consisting with 62 questions as (1) demographic and socio-economic variables and (2) Likert scale rating. Gender, Age Group, Marital Status, Education level, Designation/Position, Working Experience in this Bank, Total Working Experience and Job Category are the demographic and socio-economic variables.

3.4 Conceptual Framework

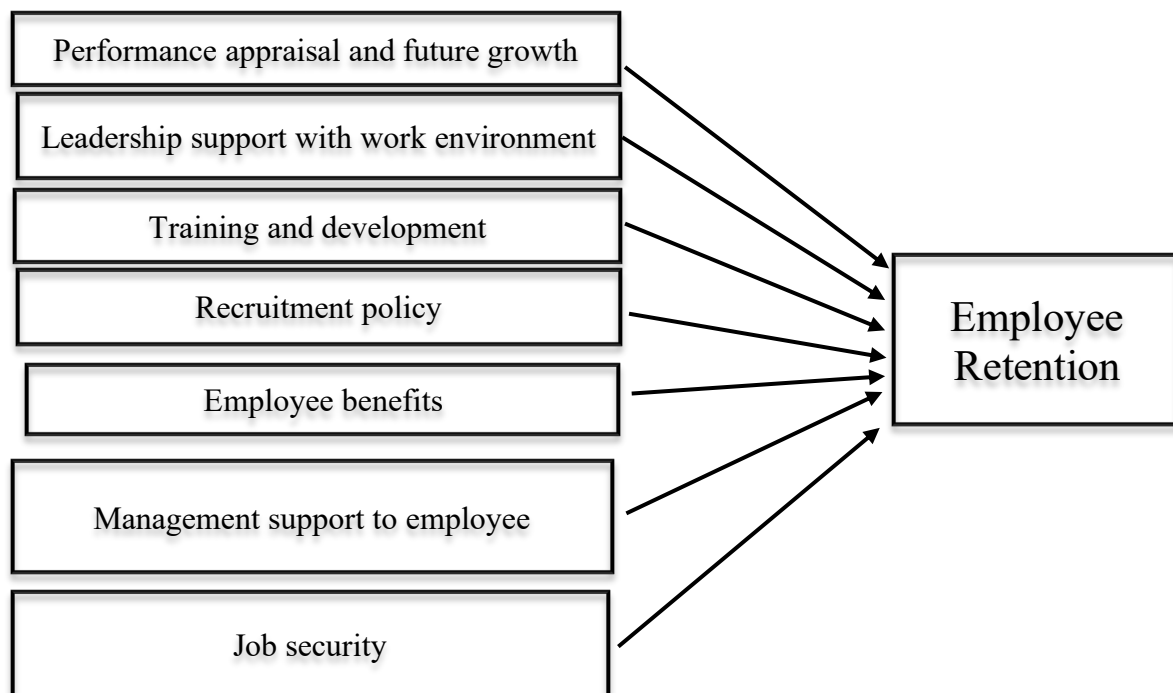

The above conceptual framework explains that employees' retention is being used as dependent variable whereas seven independent variables such as Performance appraisal and future growth, Leadership support with work

environment, Training and development, Recruitment policy, Employee benefits, Management support to employee and Job security are also being used in this research to investigate the relationship among them.

3.5 Data Collection

Data collection is the process of collecting and measuring information on variables of interest, in a recognized systematic way that enables one to answer specified research questions, and evaluate the outcomes (Cooper and Schindler, 2008). Our primary data collection method has carried out by the use of questionnaires. Questionnaires were considered a good data collection tool as they allow the researcher to collect information from a large target population within a short time period and can be done with cost-effective way (Creswell, 2013). After selecting the banks through stratified random sampling, we selected the employees with convenience sampling method. Finally, we collected data through a predesigned questionnaire by face-to-face interview. To ensure a maximum response rate, respondents was informed earlier of the time of interview and tried to make it easier for them to promise to the interview without feeling pressured.

3.6 Research Procedures

Before the administration of the questionnaire we have pre-tested to ensure reliability, relevancy and validity of the information to be collected. This pretested data has collected from a small sample only forty employees working in the banks. The main purpose of pre-testing the questionnaire is to identify the irrelevant, biased, confusing and sensitive statement in the data collection instrument and try to omit or modify them. Pre-testing permits modification before the final test (Cooper & Schindler, 2003). After pre-testing the questionnaire, we have finalized the questionnaire and collected our desire number of data for final analysis.

3.7 Data Analysis Methods

Data Analysis is a process in which data sets are analyzed, inspected and fitted to the model with the goal of discovering useful information (Elite Crest Technology, 2019). In this study, we have performed univariate, bivariate and multivariate analysis. In univariate analysis, we have displayed the variables' information with percentages and counts in a tabular/graphical form. Moreover, for bivariate analysis we performed cross-tabulation and chi-square test to investigate relationship between variables and the result have represented in a tabular form with percentage. We also performed correlation analysis to establish the relationship between the dependent variable and the independent variables. Finally, we have analyzed the data in a multivariate way. In this way we performed factor analysis and multiple regression analysis to quantify the relationship and find out the strength of dependency of dependent variable on independent variables. The empirical model is specified as:

$$\begin{aligned}
 \text{Employee Retention} = & \alpha + \beta_1 \text{Performance appraisal and future growth} \\
 & + \beta_2 \text{Leadership support with work environment} \\
 & + \beta_3 \text{Training and development} \\
 & + \beta_4 \text{Recruitment policy} \\
 & + \beta_5 \text{Employee benefits} \\
 & + \beta_6 \text{Management support to employee} \\
 & + \beta_7 \text{Job Security} + e_i
 \end{aligned}$$

4. Data Analysis & Findings

4.1 Introduction

This study is intended to assess the satisfaction of the employees of banking industry operated in Bangladesh. Consequently, data of 204 employees, those are continuing their job in different banks, was collected through structured questionnaire as a survey tool. In this section we presented the data analysis and key findings based on the various data analyses. The first part entailed Descriptive Analysis to formulate the summary of respondents' background information. Second, it involved the explanatory measurement assessment for different attributes

related to employee retention by running Factor Analysis & Reliability Analysis to conform that the constructs used in the survey tool are relevant and valid. Finally, we dealt with bivariate analysis to verify if there was any association among the dependent variable and independent variables by conducting Correlation Analysis. In addition, it demonstrated the strength and direction of relationships between independent and dependent variables by Regression Analysis.

However, before the tests were carried out it was ensured that no missing values or irrelevant values existed in the data entry, which involved Data Cleaning process. The following sub-sections with detailed statistical tests used an alpha level of 0.05 and SPSS Version 25 was used for the data analyses.

4.2 Demographic and Social Profile (Univariate Analysis)

Descriptive statistical analysis was used to identify frequencies and percentages to interpret the background information of the participants in the survey.

Table 4.1 Frequency Distribution of the Respondents' Demographic and Social Status

Variables	Category	Frequency	Percent
Gender	Male	148	72.5
	Female	56	27.5
Age Group	18 – 25	15	7.4
	26 – 33	113	55.4
	34 – 41	54	26.5
	42 and above	22	10.8
Marital Status	Married	157	77.0
	Unmarried	47	23.0
Educational level	Master's Degree	183	89.7
	Others	21	10.3
Designation	Entry-EO	134	65.7
	SEO-FAVP	53	26.0
	Above FVP	17	8.3
Working experience in this organization	1 – 5 yrs	89	43.6
	5 – 10 yrs	82	40.2
	10 yrs and above	33	16.2
Total working experience	1 – 5 yrs	81	39.7
	5 – 10 yrs	77	37.7
	10 yrs and above	46	22.5
Job category	Permanent	195	95.6
	Others	9	4.4

Table 4.1 presented the information of the respondents' personal background. The respondents' demographic characteristics consisted of three items, which included the participants' gender, age group and marital status. The respondents' social status consisted of five items, which included the educational level, designation, working experience in this organization, total working experience and Job category. As stated in the table, the majority of respondents were male, 72.5% and 27.5% were female. The survey-illustrated more than half of the respondents, 55.4%, were aged between 26 to 33 years, followed by the age group of 34 to 41, (26.5%) and 10.8% respondents aged 42 years or above. The sampling population was 77.0% married. However, about 95.6% of respondents are employed as a permanent employee. Most of the respondents, (89.7%) completed Master Degree. With regards to working experience in present organization, 43.6% of the respondents worked for 1-5 years, followed by 40.2% whose working experience was 5-10 years. More than 10 years experienced employees were 16.2%. In case of designation, more than half portion (65.7%) of the respondents were entry to Executive Officer level and exactly 26% of the respondents were Senior Executive Officer to First Assistant Vice Principal.

4.3 Bivariate Analysis

Simultaneous analysis of two variables (attributes) is known as bivariate analysis. It indicates the concept of association between two variables, whether there exist any relationship and the strength of this association. Also, it measures whether there are differences between two variables and the significance of these differences.

Table 4.2 Measuring the Significant Difference among the Demographic variables for Employee Retention Score

Gender		N (%)	Mean ± SD	P-Value
Male	t-test	148 (72.5)	3.59 ± 0.66	0.056
Female		56 (27.5)	3.42 ± 0.55	
Age group		N (%)	Mean ± SD	P-Value
18 – 25	F-test	15 (7.4)	3.33 ± 0.46	0.393
26 – 33		113 (55.4)	3.53 ± 0.68	
34 – 41		54 (26.5)	3.64 ± 0.59	
42 and above		22 (10.8)	3.53 ± 0.58	
Marital Status		N (%)	Mean ± SD	P-Value
Married	t-test	157 (77.0)	3.54 ± 0.63	0.766
Unmarried		47 (23.0)	3.57 ± 0.65	
Education level		N (%)	Mean ± SD	P-Value
Master's Degree	t-test	183 (89.7)	3.58 ± 0.62	0.033
Others		21 (10.3)	3.23 ± 0.68	
Designation		N (%)	Mean ± SD	P-Value
Entry-EO	F-test	134 (65.7)	3.60 ± 0.65	0.190
SEO-FAVP		53 (26.0)	3.41 ± 0.63	
Above FVP		17 (8.3)	3.52 ± 0.51	
Working experience in this organization		N (%)	Mean ± SD	P-Value
1 – 5 yrs	F-test	89 (43.6)	3.57 ± 0.62	0.904
5 – 10 yrs		82 (40.2)	3.53 ± 0.68	
10 yrs and above		33 (16.2)	3.51 ± 0.55	
Job Category		N (%)	Mean ± SD	P-Value
Permanent	t-test	195 (95.6)	3.55 ± 0.64	0.611
Others		9 (4.4)	3.44 ± 0.61	

Table 4.2 revealed that all are insignificant except 'Education Level' this means that there is no significant difference within the group to retain the organization or not. Since most of the variables are insignificant we cannot consider these for further analyses.

Table 4.3 Correlation between Dependent and Independent Variables.

		Employee Retention
Employee Retention	Pearson Correlation	1
	Sig. (2-tailed)	
Performance appraisal and future growth	Pearson Correlation	.478**
	Sig. (2-tailed)	.000
Leadership support with work environment	Pearson Correlation	.387**
	Sig. (2-tailed)	.000
Training and development	Pearson Correlation	.477**
	Sig. (2-tailed)	.000
Recruitment policy	Pearson Correlation	.233**
	Sig. (2-tailed)	.001
Employee benefits	Pearson Correlation	.445**
	Sig. (2-tailed)	.000
Management support to employee	Pearson Correlation	.267**
	Sig. (2-tailed)	.000
Job security	Pearson Correlation	.200**

	Sig. (2-tailed)	.004
--	-----------------	------

***. Correlation is significant at the 0.01 level (2-tailed).*

From the above table we observed that all variables are inter correlated between them with highly significant. The correlation between dependent variable (Employee Retention) and independent variables is significant at 1% level of significance.

4.4 Multivariate Analysis

4.4.1 Factor Analysis

Factor analysis is a dimension reduction technique that is used to reduce a large number of attributes to a smaller set of components. Factor analysis is used in data reduction as the analysis can group similar cases, however, it cannot distinguish between the dependent variable and independent variables (Yong & Pearce, 2013). It is used to measure constructs as well as to retain variables in a more manageable component.

The Factor Eigenvalues measured how much of the variance of the observed variables explained a factor. Factor Eigenvalues must be greater than or equal to 1 to be significant (Yong & Pearce, 2013). In this study, Principal Components Varimax Rotated Method has been used to identify the factors influencing of employee retention in banking industry of Bangladesh. Factor loading with a value of 1.5 and above are retained as they are pure measure of the constructs.

The Kaiser-Meyer-Olkin (KMO) measured how suited is the data collected for Factor Analysis. KMO value would range from 0 to 1. In addition, if the value lies between 0.8 to 1, it would indicate that the sampling is adequate, whereas if the value is less than 0.6 it would mean that the sampling is not adequate (Yong & Pearce, 2013). In our study KMO = 0.848, that indicates our samplings is adequate. Bartlett's Test of Sphericity determined the validity and suitability of the responses collected to the problem being addressed or not. In order for the factorability to be significant, the Bartlett's Test of Sphericity should be significant at ($p < 0.05$). If the significance level is lower than the recommended value of $p < 0.05$, it would indicate Factor Analysis is appropriate (Yong & Pearce, 2013). Our Bartlett's Test of Sphericity is highly significant ($p < 0.001$)

Table 4.4 KMO and Bartlett's Test

Kaiser-Meyer-Olkin Measure of Sampling Adequacy.		.848
Bartlett's Test of Sphericity	Approx. Chi-Square	3775.595
	df	990
	Sig.	.000

Table 4.5 Factors with Explained Variation

Factors	Eigen Value and Explained Variance		
	Eigen Value	% of Variance	Cumulative %
Factor 1: Performance Appraisal and Future Growth	10.575	23.499	23.499
Factor 2: Leadership Support with Work Environment	2.686	5.969	29.468
Factor 3: Training and Development	2.672	5.937	35.405
Factor 4: Recruitment Policy	2.103	4.674	40.079
Factor 5: Employee Benefits	1.890	4.200	44.279
Factor 6: Management Support to Employee	1.642	3.649	47.928
Factor 7: Job Security	1.533	3.406	51.334

After observing the KMO and Bartlett's test, to maximize the variance of each of the factors the "varimax" rotation was executed that will reallocate the accounted variance among the extracted factors. 23.499% of employee retention can be explained by first factor and the second extracted factor explained about 5.969% of variation of

employee retention. The succeeding five extracted factors are accountable for 5.937, 4.674, 4.200, 3.649 and 3.406% of employee retention respectively.

The "Screen plot" is also an important tool to identify the number of factors to be accepted. From the following scree plot we observed that after the first seven factors the Eigen values are more stable, it is suggested that extracting seven factors might be a sensible choice for the employee retention data.

Figure 4.1 Scree Plot for Eigenvalues

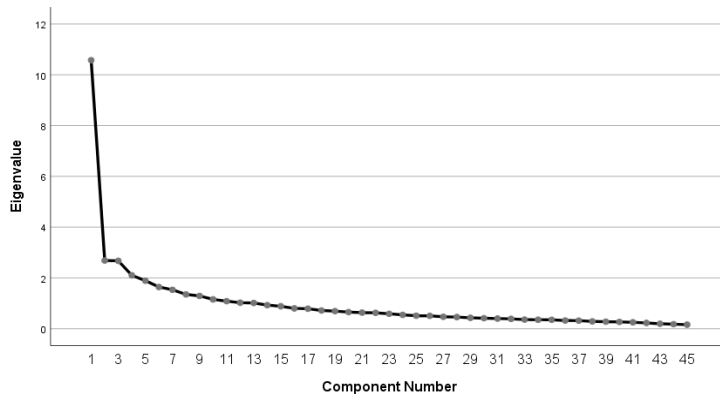

Table 4.6 Rotated Component Matrix

	Component						
	1	2	3	4	5	6	7
My Bank selects right person at right place at right time	.669						
Performance is measured with unbiasedness in my Bank	.654						
In this Bank, there is no nepotism in the selection	.647						
Performance is measured with the weight of work	.605						
It has good and transparent reward practice policy	.556						
In this Bank we have self-actualization opportunity	.514						
Performance is measured throughout the year							
It has a standard policy to measure the performance							
It provides an adequate insurance coverage plan							
Line manager shares information willingly							
Enjoyable working condition in my Bank		.680					
Always I get appreciation of my decent work		.677					
I get recognition for each work from my manager		.661					
I have freedom in my work		.621					
My manager guides me in my future career		.548					
Work is monitored by manager effectively		.542					
This Bank assigns to me a work with sufficient time & according to capacity		.542					
My assignment is clearly defined by my manager							
Working time is eight (8) hours, no need to work more/extra time							
This Bank allocates an adequate funds for training purpose			.762				
Trainings obtained from my Bank makes me competent for higher position			.725				
This Bank facilitates the clear career paths			.604				
Our training instructors are very knowledgeable			.588				
This Bank arrange contemporary training frequently			.532				
This Bank follows a standard policy to recruit employees				.626			
My colleagues are supportive and friendly				.598			

This Bank recruits from both internal and external				.594			
On time salaries and bonuses payment				.539			
My manager has good relationship with top management							
Medical allowance is sufficient to me and my family				.646			
Leave plan of my Bank is satisfactory to me				.604			
TA/DA policy is sufficient to me				.589			
Retirement benefits are very lucrative of my Bank				.581			
Hansom bonuses are provided to me							
My Bank provides sufficient compensation to me							
There is no obligation to perform my assigned work							
There are entertainment facilities e.g. sports, PIKNIK					.582		
Salary structure is standard compared to other Banks					.567		
There is a good opportunity to get experience from diversified work					.554		
This Bank assigns the challenging work							
I want to take more challenging work than my existing work							
There is no involuntary termination policy/practice without great offence							.739
In this Bank, no one has influencing power to make an involuntary termination							.730
This Bank gives sufficient time to the employee in involuntary termination							.703
The distance of my work place from my house is amenable							
Extraction Method: Principal Component Analysis. Rotation Method: Varimax with Kaiser Normalization.							

Eigenvalues, Extracted Components, and Rotated Components. It measured how strong the constructs were and how many items which assessed employee retention is included in the model. According to the analysis, there are three components in the model with Eigenvalues more than 1.5, which was subsequently retained. In this case, the factors are made by the function of observed items by removing the clutter of low correlations or low inter item relationship (those are less than 0.50) that may insignificant. These 7 factors are specified below along with their components which are found from the rotated component matrix table:

Factor 1 can be entitled to “Performance Appraisal and Future Growth” because this factor contains of high coefficients for ‘My Bank selects right person at right place at right time’ (.669), ‘Performance is measured with unbiasedness in my Bank’ (.654), ‘In this Bank, there is no nepotism in the selection’ (.647), ‘Performance is measured with the weight of work’ (.605), ‘It has good and transparent reward practice policy’ (.556) and ‘In this Bank we have self-actualization opportunity’ (.514).

Factor 2 entitled as “Leadership Support with Work Environment” this factor contains of maximum coefficients for ‘Enjoyable working condition in my Bank’ (.680), ‘Always I get appreciation of my decent work’ (.677), ‘I get recognition for each work from my manager’ (.661), ‘I have freedom in my work’ (.621), ‘My manager guides me in my future career’ (.548), ‘Work is monitored by manager effectively’ (.542) and ‘This Bank assigns to me a work with sufficient time & according to capacity’ (.542).

Factor 3 we considered as “Training and Development” this factor covers the high coefficients for ‘This Bank allocates an adequate fund for training purpose’ (.762), ‘Trainings obtained from my Bank makes me competent for higher position’ (.725), ‘This Bank facilitates the clear career paths’ (.604), ‘Our training instructors are very knowledgeable’ (.588) and ‘This Bank arrange contemporary training frequently’ (.532).

Factor 4 can be expressed as “Recruitment Policy” this factor comprises the high coefficients for ‘This Bank follows a standard policy to recruit employees’ (.626), ‘My colleagues are supportive and friendly’ (.598), ‘This Bank recruits from both internal and external’ (.594) and ‘On time salaries and bonuses payment’ (.539).

Factor 5 can be entitled to “Employee Benefits” because this factor contains of high coefficients for ‘Medical allowance is sufficient to me and my family’ (.646), ‘Leave plan of my Bank is satisfactory to me’ (.604), ‘TA/DA policy is sufficient to me’ (.589) and ‘Retirement benefits are very lucrative of my Bank’ (.581).

Factor 6 entitled as “Management Support to Employee” this factor contains of maximum coefficients for ‘There are entertainment facilities e.g. sports, PIKNIK’ (.582), ‘Salary structure is standard compared to other Banks’ (.567) and ‘There is a good opportunity to get experience from diversified work’ (.554).

Factor 7 we considered as “Job Security” this factor covers the high coefficients for ‘There is no involuntary termination policy/practice without great offence’ (.739), ‘In this Bank, no one has influencing power to make an involuntary termination’ (.730) and ‘This Bank gives sufficient time to the employee in involuntary termination’ (.703).

4.4.2 Reliability Test

Reliability test is the most commonly used measure to check internal consistency of the items in an instrument of a research. Cronbach’s alpha is widely used and is regarded as a popular test that confirmed the reliability of each measure (Tavakol&Dennick, 2011). In accessing the data from the seven variables summed to determine the job satisfaction factors scores formed a reliable scale. Thus, the reliability test using the Cronbach Alpha values was conducted prior to further analysis. The alpha values for the “Performance appraisal and future growth” (0.707), “Leadership support with work environment” (0.717), “Training and development” (0.714), “Recruitment policy” (0.756), “Employee benefits” (0.730), “Management support to employee” (0.718) and “Job security” (0.768) indicated that the items formed a scale of reasonable internal consistencies in its reliability. The highest correlation for each item with at least one item in the constructs was between the value of 0.154 and 0.534. Therefore, all of the items correlate adequately in the constructs.

Table 4.7 Reliability Analysis

Factors	Reliability Analysis	
	Number of Items	Cronbach Alpha Value
Factor 1: Performance appraisal and future growth	6	0.707
Factor 2: Leadership support with work environment	7	0.717
Factor 3: Training and development	5	0.714
Factor 4: Recruitment policy	4	0.756
Factor 5: Employee benefits	3	0.730
Factor 6: Management support to employee	4	0.718
Factor 7: Job security	3	0.768

4.4.3 Regression Analysis

4.4.3.1 Assumption Test for Regression Analysis

Linear regression is an analysis that measures whether one or more explanatory variables predict the dependent variable. The regression has some key assumptions such as Linear relationship, Multivariate normality, no or little multicollinearity, no auto-correlation & Homoscedasticity and no outliers in dataset.

4.4.3.1.1 Tests on Linearity

Figure 4.2 Scatter Plot for Linearity Test

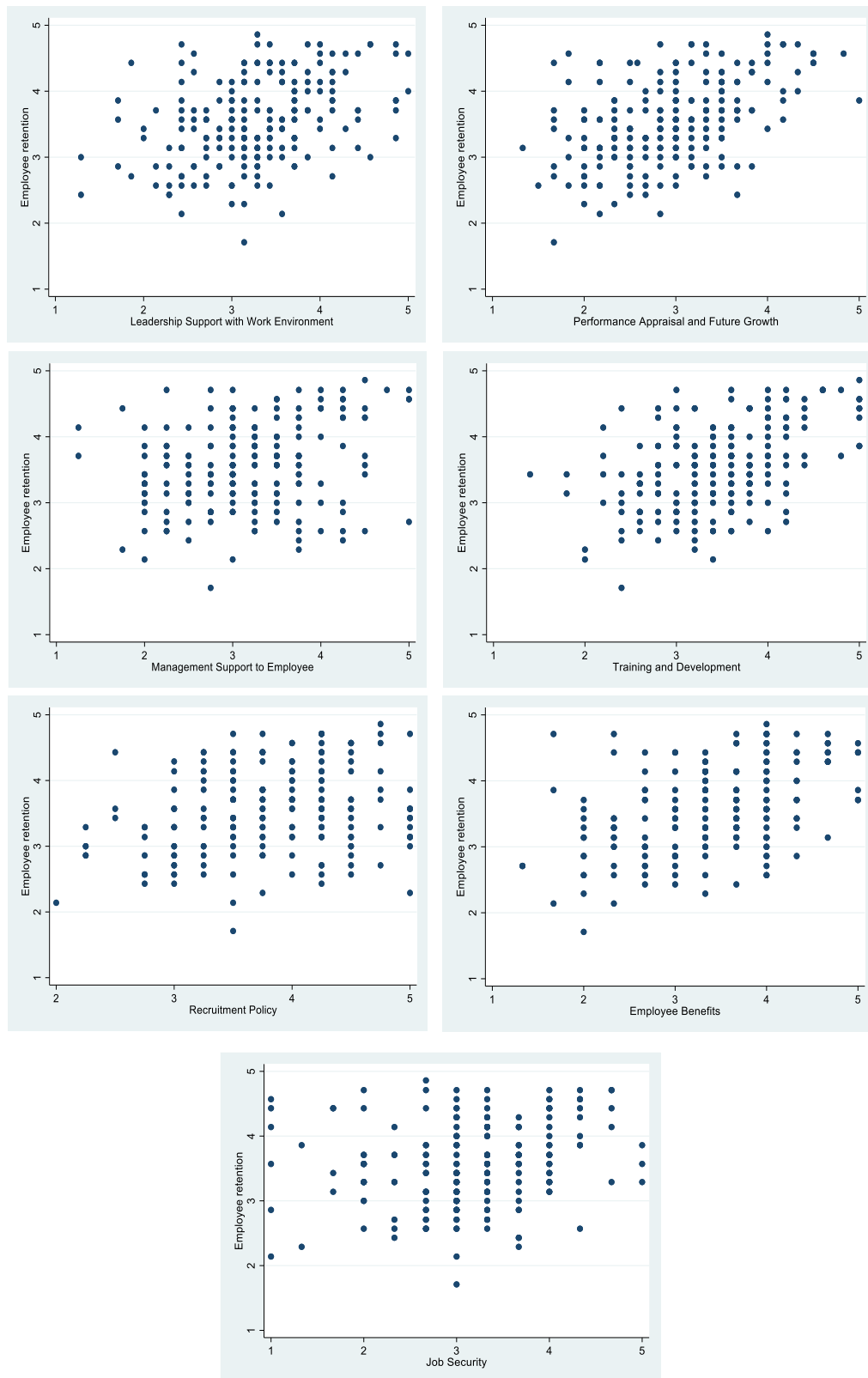

The above scatter plots represent the scatter plots of all possible independent variables with dependent variable (Employee retention). The plots illustrate that all independent variables are more or less linearly related with dependent variable

4.4.3.1.2 Tests on Normality of dependent variable

Figure 4.3 Histogram for Normality Test

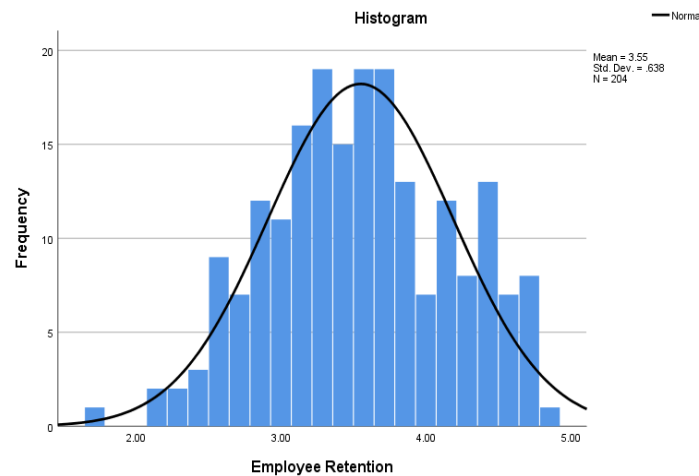

From the 4.3 figure we observed that the distribution of dependent variable is normal. This normally distributed dependent variable met our regression assumption.

The values of the residuals are independent

Table 4.8 Durbin Watson Test

	R	R square	Adjusted R square.	SE	Durbin Watson
Multiple regression model	0.60	0.36	0.34	0.51	1.92

This assumption is basically same as saying that we need our observations to be independent (or uncorrelated). This can be tested by Durbin-Watson test. This statistic can vary 0 to 4. It can be said that the values of the residuals are independent if the Durbin Watson statistic is close to 2. Values below 1 and above 3 are cause of concern. In this case the value is 1.92, so this assumption has been met.

4.4.3.1.3 Tests on Multicollinearity

Table 4.9 Variance Inflation Factor

Independent Variables	Collinearity Statistics	
	Tolerance	VIF
(Constant)		
Performance appraisal and future growth	0.562	1.780
Leadership support with work environment	0.648	1.542
Training and development	0.601	1.665
Recruitment policy	0.856	1.168
Employee benefits	0.725	1.380
Management support to employee	0.705	1.418
Job security	0.879	1.138

Here we checked the absence of multicollinearity using VIF values. All the way at the right end of the table, we found the VIF values. As stated by O'Brien 'commonly a VIF of 10 or even one as low as 4 have been used as rules of thumb to indicate excessive or serious collinearity'. By considering these rules of thumb, each value is below 10(O'Brien, 2007), indicating that the assumption is met.

4.4.3.1.4 Tests on Nonlinearity and Homogeneity of Variance

Figure 4.4 Scatter Plot for Homogeneity Test

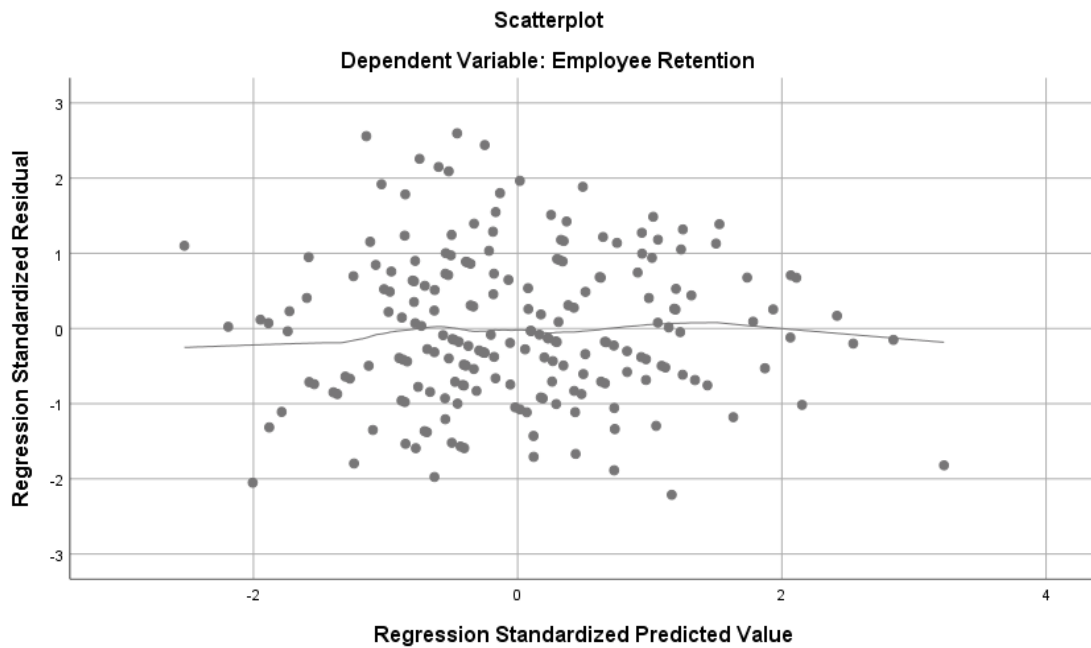

It appears that the relationship of standardized predicted to residuals is roughly linear around zero. We can conclude that the relationship between the response variable and predictors is zero since the residuals seem to be randomly scattered around zero.

4.4.3.1.5 Test on Normality for Residuals

Figure 4.5 Normal P-P plot for regression standardized Residuals

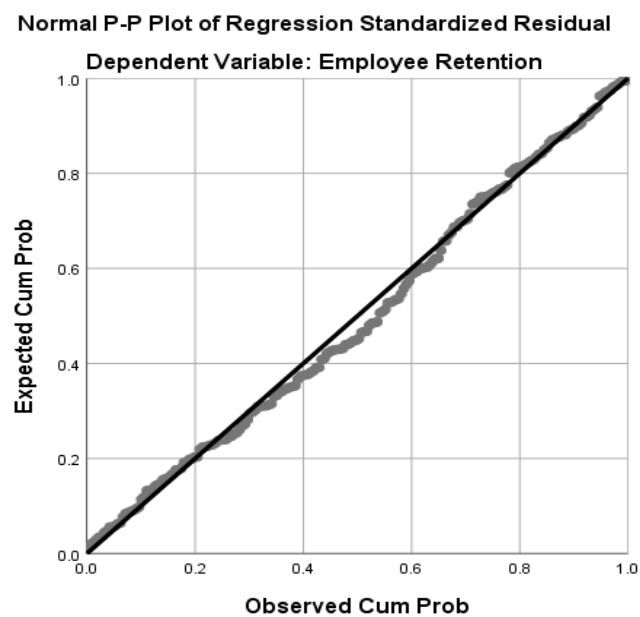

This assumption can be tested by looking at the P-P plot for the model. The closer the dots lie to the straight line the closer the residuals are normally distributed. In this case our data points mostly touch the straight line or are close to the line. So, it can be said that this assumption has been met.

4.4.3.1.6 Test for identifying the outliers.

The final assumption can be checked by going to the data set and looking the cook's distance. Any value above 1 are likely to be significant outliers, which may influence the model. In this case no such instances have occurred our maximum value is 0.07551. So, there are no influential cases biasing our model.

4.4.3.2 Simple Regression

In simple regression, there is one dependent variable and one independent variable. This is performed to quantify the dependency of dependent variable on explanatory variable (Neter J. et al., 1990).

Table 4.10 Simple Linear Regression

Influencing Factors	Unstandardized Coefficients		t	Sig.
	B	Std. Error		
Performance appraisal and future growth	0.424	0.055	7.730	0.000
Leadership support with work environment	0.343	0.058	5.957	0.000
Training and development	0.440	0.057	7.723	0.000
Recruitment policy	0.220	0.065	3.405	0.001
Employee benefits	0.358	0.051	7.062	0.000
Management support to employee	0.227	0.058	3.938	0.000
Management support to employee	0.227	0.058	3.938	0.000

***Dependent Variable: Employee Retention**

From the above table, it is revealed that if we perform simple regression by taking these seven independent variables individually all are shown the significant impact on employee retention. 'Training and development' shown the highest impact ($B=0.440$, $p<0.001$) on employee retention and minimum impact ($B=0.220$, $P=0.001$) found for the variable 'recruitment policy'.

4.4.3.3 Multiple Regression

Regression Analysis is sometimes used to build model for the relationship between dependent variables and one or more independent variables (Ramlan & Adnan, 2016). For this study Multiple Linear Regression has been chosen to estimate the relationship between a response variable and seven independent variables.

Multiple Linear Regression is an extension of Simple Linear Regression. It is used to predict the value of one dependent variable based on two or more explanatory variables (Kumar, 2014). In this study, considering employee retention as a dependent variable and tangible products, personnel service quality, level of commitment and level of compassion as independent variables Multiple Linear Regression has been performed here.

Table 4.11 Model Summary for Multiple Regression

R	R Square	Adjusted R Square	Std. Error of the Estimate
0.606	0.367	0.344	0.51679

R, the multiple correlation coefficient is the measure of the prediction of the dependent variable based on independent variables (Ramlan & Adnan, 2016). The value $R=0.606$, indicated that the level of prediction to assess employee retention was good, (Refer to table 4.11). R^2 value, (coefficient of the determination) 0.367 indicated that 36.7% of employee retention could be explained by the seven independent variables.

Table 4.12 ANOVA Table

	Sum of Squares	df	Mean Square	F	Sig.
Regression	30.353	7	4.336	16.236	0.000
Residual	52.347	196	0.267		
Total	82.700	203			

F- statistic is used for testing if the null hypothesis should be rejected or supported. The F- statistic results combined with the p value indicated that the overall results obtained in the analyses were significant (Ramlan& Adnan, 2016). However, it is to be noted that it does not indicate that all the four independent variables have significant impact on employee retention. The above table shows explanatory variables are statistically significant i.e. the model is a good fit of the data $F=16.236$, $p\text{ value}<0.001$).

Table 4.13 Multiple Regression

	Unstandardized Coefficients		t	Sig.	95.0% Confidence Interval for B	
	B	Std. Error			Lower Bound	Upper Bound
(Constant)	1.176	0.275	4.282	0.000	0.634	1.718
Performance appraisal and future growth	0.216	0.067	3.219	0.002	0.084	0.349
Leadership support with work environment	0.088	0.063	1.398	0.164	-0.036	0.211
Training and development	0.191	0.068	2.823	0.005	0.058	0.324
Recruitment policy	0.053	0.058	0.909	0.364	-0.062	0.167
Employee benefits	0.205	0.054	3.819	0.000	0.099	0.311
Management support to employee	-0.065	0.057	-1.136	0.257	-0.178	0.048
Job security	0.030	0.048	0.617	0.538	-0.065	0.124

***Dependent Variable: Employee Retention**

The P values (Sig.) from above table illustrated that the Performance appraisal and future growth, Training and development and Employee benefits are statistically highly significant i.e. these three independents variables had significant impact on employee retention.

The coefficients (B) estimated how strongly the explanatory variables influenced the dependent variable (Ramlan& Adnan, 2016). According to the values of B and P it can be said that Performance appraisal and future growth had highest significant impact ($B=0.216$, $P=0.002$) on employee retention. Based on this analysis, strength of association of Employee benefits at second ($B=0.205$, $P<0.001$) followed by Training and development ($B=0.191$, $P=0.005$). Other four independent variables have no significant impact on employee retention. In this regression analysis our all independent variables are made on the basis of factor analysis. However, the overall scenario of coefficients with p -value is given in the following figure.

Figure 4.6 Graphical Representations of Multiple Regressions

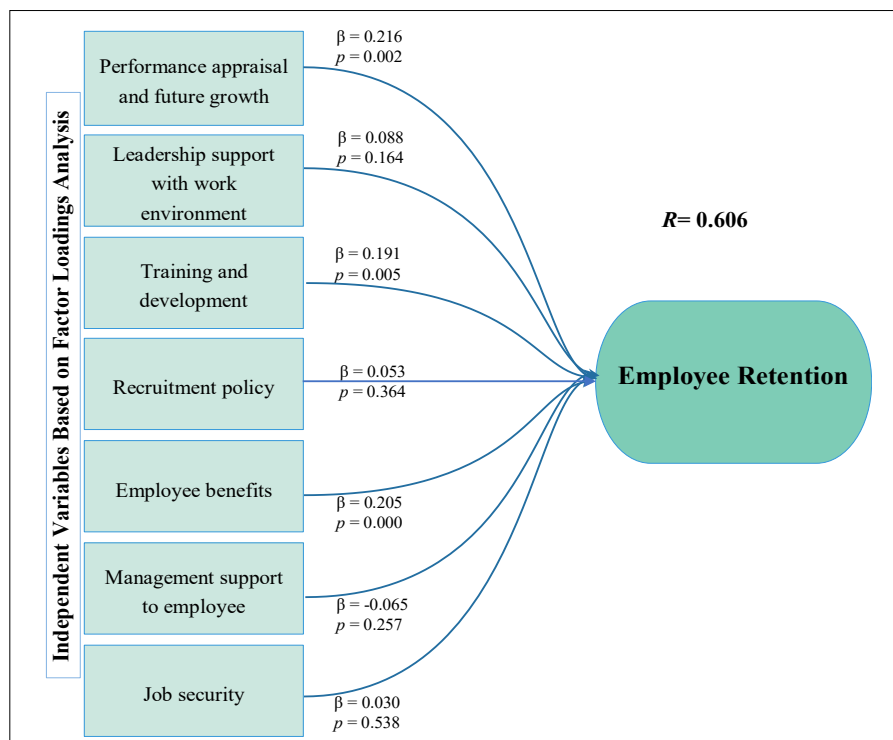

5. Conclusion and Recommendation

The main objective of the study was to examine the factors influencing employees' retention in the Private Banks of Bangladesh. The study based on the results of different statistical analysis showed that the ability of banks in Bangladesh to retain their existing employees depends on various factors. In this study we performed seven factors to investigate which are most influential factors to retain the employee. From the correlation study we observed that all these seven factors are highly correlated to the employee retention. This study also reveals that employee benefit is the most important factor to retain the employees of the organization. In our study, the employee benefits include salary structure, entertainment facilities and experience opportunities. The management of the bank should analyze the benefits of the peer banks within a certain interval and update the benefits for the employees of their organization. Respondents of this study, agree that the if the organization provides broad based training which expands their knowledge, skills and attitudes for efficient performance that is training acts as a retention tool. Respondents also argued that if the management of the bank encourages and supports training and ensures the training content is well designed and clear thus equipping them with skills, knowledge to bridge the gap between standard performance to the desired performance in the organization then employee retention rate will increase gradually for that organization. Training opportunities should also be evaluated by the management in order to increase performance and quality of the employees. The future growth opportunity is another important factor to retain the employees. If banks are to retain their existing employees, there is the need for them to pay much attention to these factors since by the nature of banks, customers develop trust and confidence in these banks if they meet the same employees they have develop friendship over time than frequently meeting different employees because of turnover.

References

- Ahmad, N., Iqbal, N. and Sheeraz, M., 2012. The effect of internal marketing on employee retention in Pakistani banks. *International Journal of Academic Research in Business and Social Sciences*, 2(8), p.270.
- An Gie Yong and Sean Pearce; *A Beginner's Guide to Factor Analysis: Focusing on Exploratory Factor Analysis*; *Tutorials in Quantitative Methods for Psychology*, 2013, Vol. 9(2), pp. 79-94, Doi: 10.20982/tqmp.09.2.p079

- Babbie, Earl R. *The Practice of Social Research*. 12th ed. Belmont, CA: Wadsworth Cengage, 2010.
- De Vaus, D. A. *Research Design in Social Research*. London: SAGE, 2001; Trochim, William M.K. Research Methods Knowledge Base. 2006.
- Duffield, C.M., Roche, M.A., Blay, N. and Stasa, H., 2011. Nursing unit managers, staff retention and the work environment. *Journal of clinical nursing*, 20(1-2), pp.23-33.
- Davidson, M. and Wang, Y. (2011). Sustainable labor practices? Hotel human resource managers views on turnover and skill shortages. *Journal of Human Resources in Hospitality and Tourism*, 10 (3), 235-253.
- Hong, E.N.C., Hao, L.Z., Kumar, R., Ramendran, C. and Kadiresan, V., 2012. An effectiveness of human resource management practices on employee retention in institute of higher learning: A regression analysis. *International journal of business research and management*, 3(2), pp.60-79.
- HamidahRamlan, MohdSharrizat Adnan; The Profitability of Islamic and Conventional Bank: Case study in Malaysia; *Procedia Economics and Finance* 35 (2016), pp. 359–367
- James, L. and Mathew, L., 2012. Employee Retention Strategies: IT Industry. *SCMS Journal of Indian Management*, 9(3).
- Johnson M (2000). *W inning the people wars: talent and the battle for human capital*. London: Prentice Hall.
- Karatepe, O. M. and Olugbade, O. A. (2009). The effects of job and personal resources on hotel employees' work engagement. *International Journal of Hospitality Management*, 28(4), 504-512.
- Kumar, R. (2014) *Research Methodology: A Step-by-Step Guide for Beginners*. 4th Edition, SAGE Publications Ltd., London.
- Lyria, R.K., Namusonge, G.S. and Karanja, K., 2017. The effect of talent retention on organizational performance of firms listed in the Nairobi Securities Exchange. *Journal of Human Resource and Leadership*, 1(3), pp.56-68.
- Mohlala, J., Goldman, G.A. and Goosen, X., 2012. Employee retention within the information technology division of a South African bank. *SA Journal of Human Resource Management*, 10(2), pp.1-11.
- Mohsen Tavakol, Reg Dennick; Making sense of Cronbach's alpha; *International Journal of Medical Education*, 2011; 2:53-55; ISSN: 2042-6372; DOI: 10.5116/ijme.4dfb.8dfd.
- Mwangi, E.K. and Omondi, M., 2016. Factors influencing staff retention in the banking industry in Kenya. A case study of equity bank limited. *Strategic Journal of Business & Change Management*, 3(2).
- Neter J, Wasserman W, Kutner MH. *Applied linear models: regression, analysis of variance, and experimental designs*. 3rd ed. Homewood, Ill: Irwin, 1990; 38– 44, 62–104
- Presbitero, A., Roxas, B. and Chadee, D., 2016. Looking beyond HRM practices in enhancing employee retention in BPOs: focus on employee–organisation value fit. *The International Journal of Human Resource Management*, 27(6), pp.635-652.
- Ritter, D. (2011). The Relationship between Healthy Work Environments and Retention of Nurses in Hospital Setting. *Journal of Nursing Management*, 11(19), 27-32.
- R.M. O'Brien, A caution regarding rules of thumb for variance inflation factors, *Qual. Quant.* 41 (2007), pp. 673–690.
- Sinha, D. & Shukla, S. K. (2013). A study of Employee Retention in the Pharmaceuticals sector in Dehradun City: *International Journal of Education and Psychological Research (IJEPR)* 2 (1), 30-39
- Salman, A., Ahmad, N. and Matin, F., 2014. Factors affecting on employees retention in banking sector: An investigation from Karachi. *European Journal of Business and Management*, 6(37), pp.2222-1905.
- Sandhya, K. and Kumar, D.P., 2011. Employee retention by motivation. *Indian Journal of science and technology*, 4(12), pp.1778-1782.
- Setia M. and SinghD.(2014). EMPLOYEE RETENTION: A CHALLENGE FACED BY INDIAN BANKING INDUSTRY- A STUDY. *International Journal of Current Research* Vol. 6, Issue, 11, pp.9856-9860, November, 2014.
- Tanchi, Khadiza Rahman, "Analyzing the Factors Influencing Employee Turnover in Private Commercial Banks in Bangladesh" *Daffodil International University Journal of Business and Economics*, Vol. 9, No. 1, PP. 119-130, June, 2015
- Yamamoto, H., 2011. The relationship between employee benefit management and employee retention. *The International Journal of Human Resource Management*, 22(17), pp.3550-3564.



Analysis of the Effect of Loan to Deposit Ratio, Non-Performing Loans and Capital Adequacy Ratio on Return on Assets with Good Corporate Governance as Intervening Variable in Banking Companies Listed in the Corporate Governance Perception Index (CGPI) for the Period 2014 – 2018

Viviana Tantiara Arsew¹, Zainul kisman¹, Ni Nyoman Sawitri¹

¹Universitas Trilogi, Indonesia

Abstract

The purpose of this study was to examine the effect of loan to deposit ratio (LDR), non-performing loans (NPL), and capital adequacy ratio (CAR) on return on assets (ROA) in banking companies listed on the Indonesian Institute for Corporate Governance (IICG) in 2014-2018. This study uses Good Corporate Governance (GCG) as an Intervening variable. The use of intervening variables GCG in this study is a recent breakthrough in increasing return on assets. The sampling technique is purposive sampling. With this sampling method, the samples used in the study were 10 of the best banking companies implementing Good Corporate Governance registered in The Indonesian Institute for Corporate Governance (IICG) in 2014-2018. This study uses secondary data obtained from SWA Magazine publications. The analysis technique used in this study is path analysis. The results of the first structural equation model that LDR and NPL have a significant negative effect on GCG and CAR has a positive significant effect. The results of the second structural equation model that NPL, CAR, GCG have an influence on ROA, but LDR does not have a significant effect. The implication of this research is that GCG as a very large variable intervening plays a role in banks in increasing ROA.

Keywords: Loan to Deposit Ratio, Non-Performing Loans, Capital Adequacy Ratio, Return on Assets, Good Corporate Governance

I. INTRODUCTION

I.1. Introduction and research rationale

The development of banking that is increasingly rapid at this time leads to increasingly fierce bank competition. As a financial institution that plays an important role in supporting the economy in Indonesia, banks face

increasingly complex risks and challenges. The risks and challenges faced by the bank are internal and external. Challenges from internal banks originate from the management of the bank itself, while external challenges from banks can originate from the economic conditions of a country where the bank operates. In addition, the condition of the country's economy which is the parent of foreign banks operating in Indonesia is also a challenge for banks. There are risks and challenges faced by banks, it is necessary to carry out an assessment related to the soundness of commercial banks in Indonesia. This assessment is intended so that commercial banks in Indonesia can survive in facing increasingly complex challenges and risks. Rating of the soundness of commercial banks is regulated in Bank Indonesia Regulation Number 13/1 / PBI / 2011 concerning Rating of Soundness of Commercial Banks. The assessment includes the integration of the bank's risk profile, Good Corporate Governance (GCG), profitability, and bank capital.

Liquidity is the company's ability to meet short-term obligations. These capabilities include the ability to provide funds when a customer requires withdrawal of deposit funds, the ability to provide funds when meeting credit requests without any delay, and the ability of a bank to maintain operational conditions in order to remain liquid (Fahmi, 2014: 117). The higher this ratio, the lower the liquidity of the bank concerned.

Financial ratios that can be used to measure credit risk are Non Performing Loans (NPL), this ratio measures the ability of banks to minimize the problem loans they face (Puspitasari, 2009).

Capital Adequacy Ratio (CAR) is a benchmark assessment of capital ratios in the context of the soundness of each bank. Capital adequacy is how a bank is able to finance its activities with capital ownership, in other words, CAR is used to measure the capital adequacy of banks to support assets that contain or generate risk, for example by granting credit to customers (Fahmi, 2014: 181).

Return On Assets (ROA) is a ratio used to show a company's ability to generate profits using total assets.

The following is empirical data about the variables used in this study, namely: loan to deposit ratio, non-performing loans, and capital adequacy ratio, return on assets (ROA) and good corporate governance. The selected sample is a banking company registered with the Indonesia Institute for Corporate Governance (IICG). Can be seen in Table 1.1 as follows :

Tabel 1: Average Banking Financial Ratios registered at The Indonesian Institute for Corporate Governance (IICG) in 2014-2018.

Variable	Years				
	2014	2015	2016	2017	2018
LDR (%)	84,95	85,91	84,61	84,97	87,22
NPL (%)	1,20	1,23	1,17	1,18	1,15
CAR(%)	17,01	17,96	19,70	19,73	19,83
GCG(score)	83,95	83,90	85,03	85,78	88,27
ROA(%)	2,50	2,40	2,42	2,53	2,70

Sources: Financial statement in IDX; data processed.

Based on table 1, it can be seen that the financial ratios of banks registered at banking companies registered at the Indonesia Institute for Corporate Governance (IICG) in the 2014-2018 period fluctuated each year. Increases and decreases in ROA are also followed by three independent variables: loan to deposit ratio, non-performing loans, capital adequacy ratio and good corporate governance as an intervening variable.

I.2. Research Objectives

1. Want to test how the influence Loan to Deposit Ratio, Non-Performing Loans, Capital Adequacy Ratio on Good Corporate Governance
2. Want to test how the influence of Loan to Deposit Ratio, Net Performing Loans, Capital Adequacy Ratio on Return On Assets.

II. LITERATURE REVIEW AND HYPOTHESIS FORMULATION

Grand Theory, Empirical Evidence and Hypothesis Formulation

Agency Theory

According to Atmaja (2018), Agency theory states that there is an asymmetry between managers (agents) and shareholders (principals) where managers are more aware of internal information and company prospects in the future compared to shareholders and other stakeholders. Principals will sacrifice their resources in the form of compensation received by the agent, with compensation given to the agent, the principal hopes to reduce differences of opinion and reduce actions that deviate from the interests of the principal. For this reason, principal will set rules such as GCG to oversee managers or banker.

Trade-Off Theory

According to Brigham, and Ehrhardt (2005). This theory explains the idea that how much is the company's debt and how much is the company's equity resulting in a balance between costs and profits. This theory states that a company has an optimal debt level and tries to adjust its actual debt level to the optimal point when the company is at a debt level that is too high (overleveraged) or too low (undelivered). In a stable condition, the company will adjust its debt level to the average level of the debt in the long run. Debt and equity balances are needed so that managers (agents) can achieve optimal company or bank ROA.

Signaling Theory

According to Brigham and Hosuton (2014), signaling theory is a behavior of company management in giving instructions to investors regarding management's views on the company's prospects for the future. In the framework of signal theory, it is stated that the impetus of the company to provide information is because there is information asymmetry between company managers and outsiders, this is because company managers know more information about the company and prospects to come than outsiders. By submitting this information to an external party, the external party is expected to provide a proportional and positive response. So the profit or ROA is optimal.

Relationship of Loan to Deposit Ratio to Good Corporate Governance.

According to Mulyono (1995), the LDR ratio is the ratio of the ratio between the number of funds channeled to the community (credit) with the number of community funds and own capital used. This ratio illustrates the ability of banks to repay withdrawals by depositors by relying on loans provided as a source of liquidity. The higher this ratio the lower the ability of bank liquidity (Dendawijaya, 2000).

The following are the results of previous studies: Kiswanto & Ari (2016) states that the Loan to deposit ratio has a significant effect on Good Corporate Governance.

Based on previous research above, it can be made a hypothesis of the relationship between the two variables as follows:

H1: LDR has a positive effect on GCG

Relationship of Non-Performing Loan to Good Corporate Governance.

According to Ismail (2009), Non-Performing Loan (NPL) is a situation where the customer is unable to pay part or all of his obligations to the bank as agreed. Each bank must be able to manage credit well in giving credit to the public and in returning credit according to the terms and conditions that apply so as not to cause problem loans.

According to Taswan (2006) and Kisman (2017), the ratio used to assess financial performance in managing non-performing loans is the NPL (Non-Performing Loan) ratio. Nonperforming loans are classified as Collectible, Current, Substandard, Doubtful and Loss. The smaller the NPL, the smaller the credit risk borne by the bank. Banks in conducting credit must conduct an analysis of the ability of debtors to repay their obligations. After credit is granted, banks are required to monitor the use of credit and the ability and compliance of debtors in fulfilling their obligations. The Bank conducts a review and binding of collateral to minimize credit risk. Banking practitioners agree that the safe limit of a bank's NPL must not exceed 5%.

Research by Ika Permata and Retno (2018), states that Net Performing Loans have a significant and positive effect on Good Corporate Governance.

Based on previous research above, it can be made a hypothesis of the relationship between the two variables as follows:

H2: NPL has a positive effect on GCG.

Relationship of Capital Adequacy Ratio to Good Corporate Governance

According to Kuncoro (2011), CAR is capital adequacy ratio that shows banks in maintaining sufficient capital and the ability of bank management to identify, measure, monitor, and control risks that arise that can affect the amount of bank capital.

According to Bank Central of Indonesia (Number 9/13 / PBI / 2007), CAR is the provision of minimum capital for banks based on broad risk assets, both assets listed in the balance sheet and administrative assets as reflected in obligations that are still contingent and / or commitments provided by banks for third parties or market risk. In other words, CAR is the ratio of bank performance to measure the adequacy of capital owned by banks to support assets that contain or generate risk, for example, loans.

Research by Kiswanto & Ari (2016), states that the Capital Adequacy Ratio has a significant effect on Good Corporate Governance.

Based on previous research above, it can be made a hypothesis of the relationship between the two variables as follows:

H3: CAR has a positive effect on GCG.

Relationship of Loan to Deposit Ratio, Non-Performing Loans, Capital Adequacy Ratio simultaneously to Good Corporate Governance

Based on the existing theories and previous research, the researcher wants to analyze the effect of Loan to Deposit Ratio, Net Performing Loans, Capital Adequacy simultaneously on Good Corporate Governance. How the relationship between variables above can be seen from the explanation below.

Banking liquidity (LDR) needs to be managed to meet the needs when customers take their funds and distribute loans (credit) to borrowers (debtors). If the LDR value is too high, it means that the bank does not have sufficient liquidity to cover its obligations to customers (depositor, third-party funds or in Indonesia called the DPK). Conversely, if the LDR value is too low, it means that banks have sufficient liquidity but their income (interest income) may be lower because as is well known, the banking world earns income through loans.

The higher Net Performing Loans can mean that the quality of bank credit is getting worse and the NPL ratio is not reasonable causing loss of opportunity to obtain income from loans and banks must accept losses and operational activities due to non-performing loans.

Capital Adequacy Ratio is the ratio of bank performance to measure the adequacy of capital owned by banks to support assets that contain or generate risk, for example, loans granted.

Based on relationship and previous research above, it can be made a hypothesis of the relationship between the four variables as follows:

H4: Loan to Deposit Ratio, Net Performing Loans and Capital Adequacy Ratio have simultaneously effect on Good Corporate Governance

Relationship of Loan to Deposit Ratio to Return On Assets.

Loan to Deposit Ratio (LDR) reflects the ratio between financing provided by commercial banks to their customers compared with funds that have been entered or collected from the public. Banks that have large total assets, have the opportunity to extend credit to the borrowers in large numbers, so as to obtain high profits (Alper et al., 2011). The size of the LDR ratio of a bank will affect bank profitability. The higher the LDR owned by a bank also shows that the bank's ability to obtain profits the better. So it can be said that LDR has a positive effect on ROA (Kisman,2017).

Research by Restiyana (2011) shows that LDR has a positive effect on ROA.

Based on previous research above, it can be made a hypothesis of the relationship between the two variables as follows:

H5: Loan to Deposit Ratio has a positive effect on Return On Assets.

Relationship of Non-Performing Loans to Return On Assets.

The NPL ratio shows the ability of bank management to managing non-performing loans provided by banks. The higher the NPL ratio, the worse the quality of bank credit that causes the number of problem loans is greater so that it can cause the possibility of a bank in a greater problematic condition.

The following are the results of several previous studies that Non-Performing Loans negatively affect ROA (Indah and Arief,2015). Meanwhile, according to Ayu (Aye et al.,2017) and Kisman (2017), that the Non-Performing Loan has a significant effect on profitability.

Based on explanation above, it can be made a hypothesis of the relationship between the two variables as follows:

H6: Non-Performing has negative effects on Return On Assets.

Relationship of Capital Adequacy Ratio to Return On Assets

According to Darmawi (2011), one component of the capital factor is capital adequacy. The ratio to test the bank's capital adequacy ratio is CAR (Capital Adequacy Ratio). CAR shows how far all bank assets that contain ratios that show how far all bank assets that contain risks (credit, inclusion of securities, bills at other banks) are financed from the bank's own capital funds in addition to obtaining funds from sources outside the bank, such as public funds, loans (debt), and others.

Research by Restiyana (2011) and Deden (2016), shows that the Capital Adequacy Ratio has a positive and significant effect on Return On Assets.

Based on previous research above, it can be made a hypothesis of the relationship between the two variables as follows:

H7: Capital Adequacy Ratio has a positive effect on Return On Assets.

Relationship of Good Corporate Governance to Return on Assets.

Research on good corporate governance provides empirical evidence that the variable of good corporate governance is an important factor in determining company value and influencing company profitability.

Good corporate governance also guarantees profit and security of funds invested in banks that will not be embezzled by bank managers. The implementation of good corporate governance can prevent mistakes in decision making so that it will automatically increase the value of the company, which is reflected in profitability.

Research by Anjani and Yadnya (2017) Good Corporate Governance has a significant effect on Return On Assets.

Based on previous research and explanation above, it can be made a hypothesis of the relationship between the two variables as follows:

H8: Good Corporate Government has a positive effect on Return On Assets.

Relationship of Loan to Deposit Ratio, Net Performing Loans, Capital Adequacy Ratio and Good Corporate Governance simultaneously to Return On Assets

Based on the existing theories and previous research, this study wants to analyze the effect of Loan to Deposit Ratio, Non-Performing Loans, Capital Adequacy Ratio and Good Corporate Governance simultaneously on Return on Assets. How the relationship between variables above can be seen from the explanation below.

Loan to Deposit Ratio, Non-Performing Loans, Capital Adequacy Ratio and Good Corporate Governance are of the ratio that can be used in terms of measuring the financial performance of the bank. Then the changes in the four ratios also partially affect ROA as explained above. In line with the partial influence above, it is simultaneously expected that LDR, NPL, CAR and GCG influence ROA.

Based on explanation above, it can be made a hypothesis of the relationship between the five variables as follows:

H9: Loan to Deposit Ratio, Non-Performing Loans, Capital Adequacy Ratio and Good Corporate Governance have simultaneously effect on Return On Assets.

Relationship of Loan to Deposit Ratio, Net Performing Loans, Capital Adequacy Ratio to Return On Assets with Good Corporate Governance as an intervening variable.

Loan to Deposit Ratio is a ratio that measures the extent of the bank's ability to repay withdrawals of funds made by depositors by relying on loans provided as a source of liquidity. The higher this ratio, the lower the liquidity of the bank concerned. But on the contrary, the lower the LDR ratio, the higher the liquidity of the bank concerned. This ratio is also an indicator of the vulnerability and ability of a bank.

A non-performing loan is a situation where the customer is unable to pay part or all of his obligations to the bank as agreed. Each bank must be able to manage credit well in giving credit to the public and in returning credit according to the terms and conditions that apply so as not to cause problem loans. The smaller the NPL, the smaller the credit risk borne by the bank.

Capital Adequacy Ratio is capital adequacy that shows banks in maintaining adequate capital and the ability of bank management to identify, measure, supervise, and control the risks that arise that can affect the amount of bank capital (Kuncoro, 2011).

Good Corporate Governance (GCG) is a healthy corporate governance procedure that has been introduced by the Indonesian government and the International Monetary Fund (IMF). This concept is expected to protect shareholders and creditors so that they can regain their investment.

Return On Assets is a ratio used to measure a company's ability to generate profits by using the total assets owned by the company after adjusting for costs to fund these assets (Hanafi and Halim, 2007).

Based on the description above, it can be seen that the independent variables with intervening variables in research affect each other and have a relationship with the dependent variable. The relationship that occurs between the independent variable and the intervening variable is expected to be an interrupting variable between the independent variable and the dependent variable so that the independent variable does not directly affect the emergence of the dependent variable.

Based on previous research and explanation above, it can be made a hypothesis of the relationship between the five variables as follows:

H10: Loan to Deposit Ratio, Non-Performing Loans, Capital Adequacy Ratio have an effect on Return On Assets with Good Corporate Governance as an intervening variable.

III. RESEARCH METHODS

III.1 RESEARCH METHODS

The object of this study is the Banking Companies listed on the Indonesia Stock Exchange, which have a score of Corporate Governance Perception Index of the Indonesian Institute for Corporate Governance Period 2014 - 2018. Types of data used in this study are secondary data, namely in the form of panel data for all related variables. The population in this study is banking with a total of 45 companies.

Based on sample selection, the total sample of Banking listed on the Indonesia Stock Exchange that has a score of Corporate Governance Perception Index of The Indonesian Institute for Corporate Governance (IICG) that meets the criteria is 10 companies listed on the Indonesia Stock Exchange in 2014-2018.

III.2. POPULATION AND SAMPLE

The population used in this study is that the banks listed on the Indonesia Stock Exchange have a score of 10 companies in the Corporate Governance Perception Index of the Indonesian Institute for Corporate Governance (IICG).

The sampling criteria for this study are as follows:

1. Banking Companies listed on the Indonesia Stock Exchange during the observation period, namely 2014 - 2018.
2. Companies that publish data on company financial statements that are published on the Indonesia Stock Exchange at the end of each year during monitoring, namely 2014 - 2018.
3. Banking Companies that have a Corporate Governance Perception Index of the 2014 Indonesian Corporate Governance Institute (IICG).

This study uses secondary data. Secondary data is data that has been processed by the relevant institution which is sourced from the financial statements of the related company that has been audited and published to the general public. The financial report data is obtained from the website of the Indonesia Stock Exchange through www.idx.co.id.

III.3 METHOD OF ANALYSIS

In this study, the analysis method is carried out by path analysis which is a development of the regression model. Through this path analysis, the regression equation involves independent and dependent variables by testing intervening variables. Path analysis can also measure the relationship between variables in the model both directly and indirectly.

III.4. DEFINITION ON OF OPERATIONAL VARIABLES

Dependent Variables

The definition of operational variables is very important in research. This is intended to avoid misunderstandings or differences in perceptions regarding the data to be collected. In this study Return On Assets are used as dependent variables.

Return On Assets is a ratio used to measure a company's ability to generate profits.

Independent Variables

Loan to Deposit Ratio (LDR)

Loan to Deposit Ratio (LDR) is the ratio between the total volume of credit extended by banks and the number of funds received from various sources. LDR is the company's financial ratio related to liquidity.

Non-Performing Loans (NPL)

Part of bank credit that is not smooth until the bad debt where the bank did not manage to pull it back

Capital Adequacy Ratio (CAR)

Capital Adequacy Ratio is the ratio of the adequacy of capital owned by banks to support assets that contain or generate risk, for example, loans granted.

Intervening Variable

GCG is a score of Corporate Governance Perception Index of The Indonesian Institute for Corporate Governance (IICG).

III.5. DATA ANALYSIS

The analysis technique used in this study is path analysis. Before the path analysis is carried out, the assumption of path analysis must first test. The test consists of normality, multicollinearity, and heteroscedasticity. The path analysis model is as follows:

Substructure Equation 1:

$$Y = \rho_{yx1} x_1 + \rho_{yx2} x_2 + \rho_{yx3} x_3 + \epsilon_1$$

Substructure Equation 2:

$$Z = \rho_{zx1} x_1 + \rho_{zx2} x_2 + \rho_{zx3} x_3 + \rho_{zy} y + \epsilon_2$$

Figure 1: Framework for Research Models

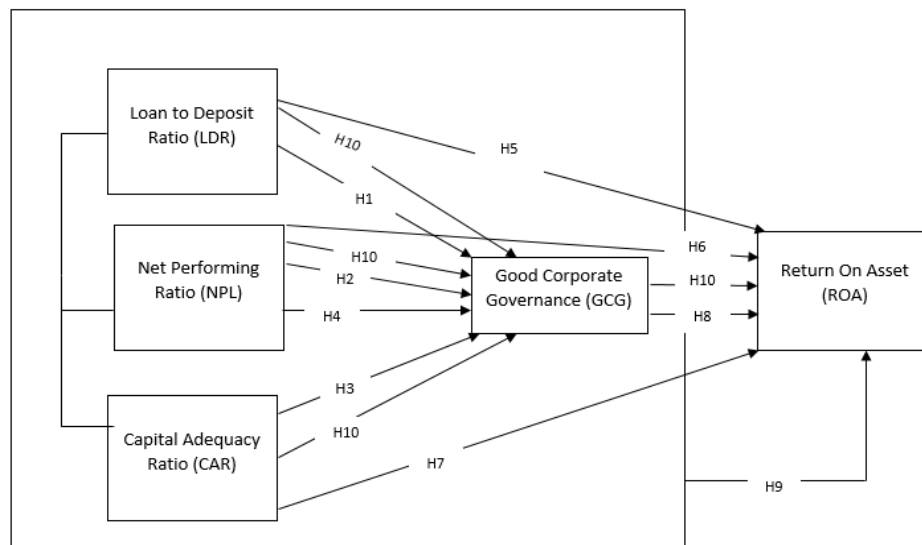

The application of GCG principles and practices will increase domestic investor confidence in the company. The benefits of implementing Good Corporate Governance (Daniri, 2014) can reduce agency costs and the cost of capital, and increase profitability (ROA) also the value of shares. The challenges of banking in the future not only lie in intense competition but also include weak banking capabilities, sustainable profitability and efficiency of bank operations, customer protection and information technology that still needs to be improved.

Trust and partiality in the interests of the community are a final estuary of banking integrity. Banking consolidation is based on three strengths, namely, capital-based, good corporate governance and corporate culture will be the eyes of the banking heart and are expected to illuminate national integrity. The application of GCG principles and practices will increase domestic and international investor confidence in the company and ultimately can increase profitability and value of shares.

IV. RESULTS AND DISCUSSION

Before conducting statistical analysis, the data to be processed, first must meet the regression analysis assumptions (Ghozali,2013).

TESTING OF THE REGRESSION ANALYSIS ASSUMPTION AND RESULT.

Substructure Equation 1:

Before conducting statistical analysis, the data to be processed, first must meet the regression analysis assumptions.

Table 2: One-Sample Kolmogorov-Smirnov Test (Normality Test)

		Unstandardized Residual
N		50
Normal Parameters ^{a,b}	Mean	,0000000
	Std. Deviation	,01240605
Most Extreme Differences	Absolute	,091
	Positive	,050
	Negative	-,091
Test Statistic		,091
Asymp. Sig. (2-tailed)		,200 ^{c,d}

a. Test distribution is Normal.

b. Calculated from data.

c. Lilliefors Significance Correction.

In table 2 above, the Asymp value is obtained. Sig (2- tailed) of 0.200 or can be written as a probability value (P-value) = 0.200 > 0.05 or Ho is accepted. Thus, residual data are normally distributed.

Table 3: Autocorrelation Test (Durbin- Watson) Model Summary

Model	R	R Square	Adjusted Square	R	Std. Error of the Estimate	Durbin-Watson
1	,696 ^a	,485	,451		,01280	,872

Source: data processed

From Table 3 above, the results of autocorrelation with Durbin - Watson are 0.872, which means that the autocorrelation category does not occur because the D-W number is between -2 to 2 (Singgih, 2013)

Table 4 : Tolerance dan VIF (Multicollinearity Test)

Model	Colinearity Statistics	
	Tolerance	VIF
1 (Constant)		
LDR	0,888	1,126
NPL	0,825	1,212
CAR	0,827	1,208

Source: data processed

Based on the results of testing the tolerance value (see Table 4 above) also shows that there is no independent variable that has a tolerance value below or less than 0.10, which means that there is no correlation between the

independent variables whose value is more than 95%. The results of the calculation of Variance Inflation Factor (VIF) also showed the same results, namely, there are no independent variables that have a VIF value ≥ 10 . So it can be said and concluded that there is no multicollinearity between the independent variables in the regression model.

Figure 2: Scatterplot graph (Heteroscedastisity Test)

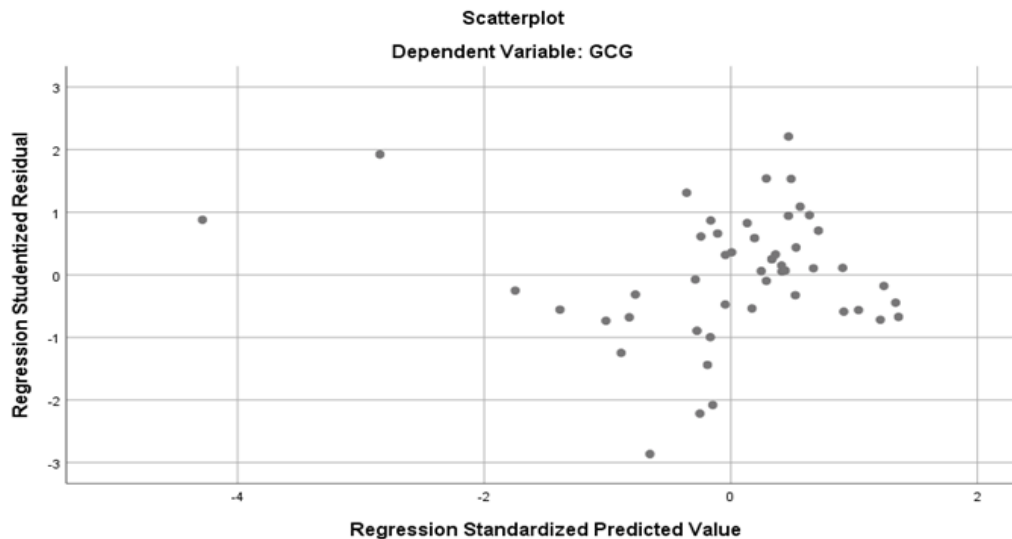

Based on Figure 2 above, there is a scatterplot graph that shows the points of diffuse and does not form certain clear patterns. So it can be concluded that there are no symptoms of heteroscedasticity.

Table 5: Summary of Results : Substructure Equation 1

Model	Standardized Coefficients B	t-test Sig.	Description	F-test and Sig.	R-Square
LDR → GCG	-,244	0,035	Significant	0.000 Significant	0.485
NPL → GCG	-,560	0,000	Significant		
CAR → GCG	,239	0,046	Significant		

Table 5 above is a summary table for substructural model equations 1. The data information contained in table 5 is derived from the processing of multiple regression analysis data. Table 5 will be used to assess whether the substructural 1 equation model is good enough (fit model) or not. Then the results in table 5 will be used to see the direct or non-direct effect on ROA in Figure 4.

Based on the table, the substructural 1 equation model is considered to be quite good (fit model) because all the independent variables (LDR, NPL and CAR) are significant and simultaneously also significant (see F-test). The R-squares are quite moderate. So overall the substructural 1 equation model and its coefficient information are valid and unbiased. Therefore we can draw conclusions using the data in table 5. Furthermore, the results can be used for the path analysis that is the basis of this research analysis (see Figure 4).

Substructure Equation 2:

Table 6: One-Sample Kolmogorov-Smirnov Test (Normality Test)

		Unstandardized Residual
N		50
Normal Parameters ^{a,b}	Mean	,0000000
	Std. Deviation	,34215523
Most Extreme Differences	Absolute	,091
	Positive	,091
	Negative	-,071
Test Statistic		,091
Asymp. Sig. (2-tailed)		,200 ^{c,d}

a. Test distribution is Normal.

b. Calculated from data.

c. Lilliefors Significance Correction.

d. This is a lower bound of the true significance.

Tabel 7: Autocorrelation Test (Durbin- Watson) Model Summary^b

Model	R	R Square	Adjusted Square	R	Std. Error of the Estimate	Durbin-Watson
1	,892 ^a	,795	,777		,35704	1,328

a. Predictors: (Constant), GCG, LDR, CAR, NPL

b. Dependent Variable: ROA

From Table 7 above, it can be seen that the Durbin-Watson value is 1.328 in the autocorrelation free region because it is between -2 to +2. So the decision taken in the autocorrelation test is accepted Ho, reject H1. It means that this test does not contain an autocorrelation problem. Thus it can be concluded that the regression equation model is free from autocorrelation symptoms.

Tabel 8: Tolerance dan VIF (Multicollinearity Test)

Model	Colinearity Statistics	
	Tolerance	VIF
1 (Constant)		
LDR	0,805	1,241
NPL	0,549	1,821
CAR	0,758	1,319
GCG	0,515	1,941

Source: data processed

Based on Table 8, the results of testing the tolerance value also shows that there is no independent variable that has a tolerance value below or less than 0.10, which means that there is no correlation between the independent

variables whose value is more than 95%. The results of the calculation of Variance Inflation Factor (VIF) also showed the same results, namely, there are no independent variables that have a VIF value ≥ 10 .

Figure 3. Scatterplot graph (Heteroscedastisity Test)

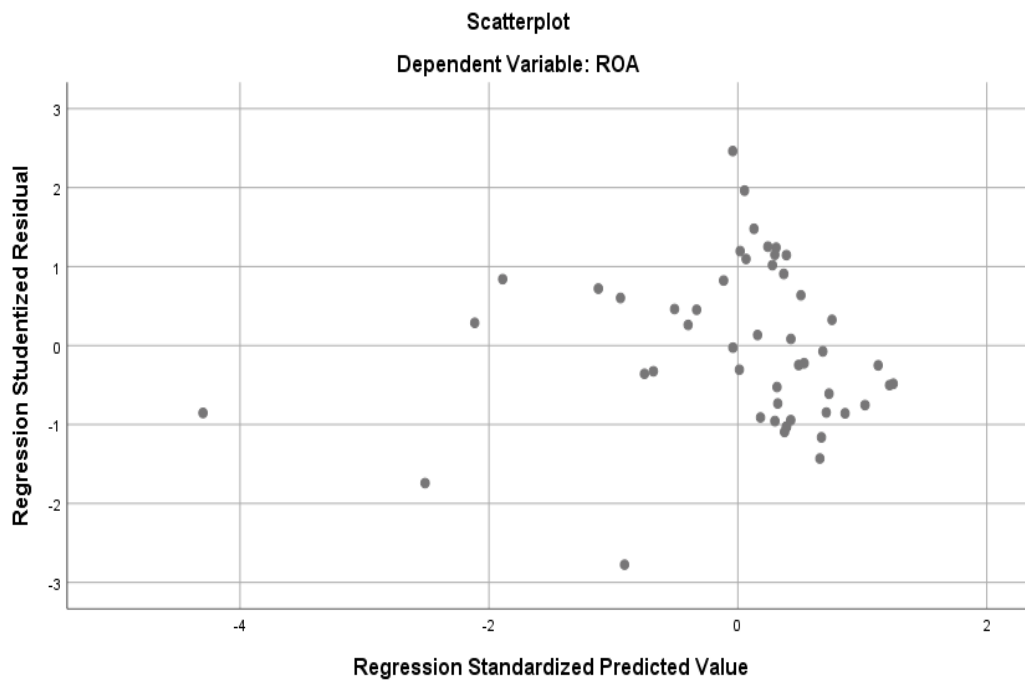

Based on Figure 3 above, there is a Scatterplot graph that shows the scattered points do not form a certain clear pattern. So it can be concluded that there are no symptoms of heteroscedasticity.

Table 9: Summary of Results: Substructure Equation 2

Model	Standardized Coefficients B	t-test Sig.	Description	F-test and Sig.	R-Square
LDR \rightarrow ROA	-.062	0.411	Not Significant	0.000 Significant	0.795
NPL \rightarrow ROA	-.505	0.000	Significant		
CAR \rightarrow ROA	.433	0.000	Significant		
GCG \rightarrow ROA	.175	0.006	Significant		

Table 9 above is a summary table for substructural model equations 2. The data information contained in table 9 is derived from the processing of multiple regression analysis data. Table 9 will be used to assess whether the substructural 2 equation model is good enough (fit model) or not. Then the results in table 9 will be used to see the direct or non-direct effect on ROA in Figure 4.

Based on the table, the substructural 2 equation model is considered to be quite fit because all the independent variables (NPL, CAR and GCG) except LDR are significant. LDR not significant because the size of the interbank credit that is sampled is very different. Simultaneously, all variables also significant (see F-test). The R-squares are high. So overall the substructural 2 equation model and its coefficient information are valid and unbiased. Therefore we can draw conclusions using the data in table 9. Furthermore, the results can be used for the path analysis that is the basis of this research analysis (see Figure 4).

Path Analysis

Path Analysis is to combine the data in Table 5 and Table 9 to see the direct and indirect effects in order to solve the problem of how to improve ROA by using GCG intervening variables.

Figure 4: Coefficient of Path Analysis

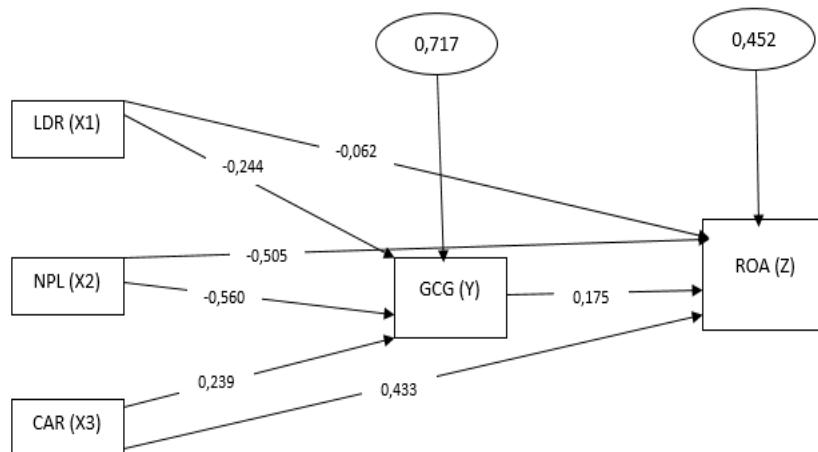

Source: data processed

The path coefficient interpretation is as follows:

- Effect of LDR on ROA :
Direct influence = -0,062
Indirect influence (through GCG) = $-0,244 \times 0,175 = -0,0427$
Total influence = $-0,062 + (-0,0427) = -0,1047$
- Effect of NPL on ROA
Direct influence = -0,505
Indirect influence (through GCG) = $-0,560 \times 0,175 = 0,098$
Total influence = $-0,505 + 0,098 = -0,407$
- Effect of CAR on ROA
Direct influence = 0,433
Indirect influence (through GCG) = $0,239 \times 0,175 = 0,0418$
Total influence = $0,433 + 0,0418 = 0,4748$
- The effect of GCG on ROA = 0,175

The above results are summarized in Table 10. Table 10 will be able to show the role of each variable influencing the ROA and the role of GCG as intervening variable.

Tabel 10: Summary of the Value of Direct Effects, Indirect Effects and Total Effects Between Variables

Influence of Variables	Direct influence	Indirect influence (through GCG) : intervening variable	Total influence
LDR (X1) → ROA (Z)	-0.062	$-0.244 \times 0.175 = -0.0427$	-0.1047

NPL (X2) → ROA (Z)	-0.505	$-0.560 \times 0.175 =$ 0.098	-0.407
CAR (X3) → ROA (Z)	0.433	$0.239 \times 0.175 =$ 0.0418	0.4748
GCG (Y) → ROA (Z)	0.175		0.175
LDR (X1) → GCG (Y)	-0.244		-0.244
NPL (X1) → GCG (Y)	-0.560		-0.560
CAR(X1) → GCG (Y)	0.239		0.239

Source: Data Process

Based on the above calculation Table 10, it can be concluded as follows:

1. Loan to Deposit Ratio has an indirect effect on Return On Assets, from the calculation results that the direct effect of -0.062 is smaller than the indirect effect - 0.0427(through GCG). Because LDR to ROA directly has no significant effect based on table 9. So it is better to influence LDR on ROA through GCG (intervening variable) than directly. This means that LDR in influencing ROA through GCG can be seen GCG as intervening variable and here plays a role in increasing ROA. This role is due to GCG improving loan management (LDR) and reducing the risk of bad credit (NPL) and capital management (CAR). So that the overall total LDR effect on ROA increases when managing GCG better.
2. Non-Performing Loans have an indirect effect on Return On Assets, from the results of calculations that the direct effect of -0.505 (lowers ROA).But indirect effect of 0.098 (through GCG). This path also shows that GCG acts as an intervening variable from NPL to ROA. Like the LDR to ROA path. NPL has an effect on increasing ROA through the application of GCG because the decrease in NPL in this period has an impact on improving GCG scores. An increased GCG score means better bank governance. Furthermore, it affects the increase in ROA. So once again here the role of GCG as an intervening variable between NPL and ROA is clearly seen because it increases ROA. The role of GCG has also been shown in the upper path between the influence of LDR on ROA through GCG. GCG here shows its role of reducing smaller ROA decreases due to an increase in NPL when there is GCG as an intervening variable.
3. Capital Adequacy Ratio has a direct effect on Return On Assets, from the calculation results that the direct effect of 0.433 , and this increase in ROA will increase if the bank applies GCG. The addition of ROA due to CAR (through GCG) is 0.0418. So that overall ROA increases higher than not applying GCG. Capital Adequacy Ratio is the ratio of bank performance to measure the adequacy of capital owned by banks to support assets that contain or generate risk. The increasing quality of CAR will be an influence on the increase in profits shown by ROA, this is very supportive for the continuity of business activities more adequately on capital, the tendency of an increase in profits generated on assets will also increase. So that this condition needs to be maintained by the Bank, or more enhanced its CAR because more CAR increases automatically raise the public's trust in the Bank that optimal management of CAR can increase the value of GCG.
4. The role of GCG can improve ROA. And that role can be seen by comparing the direct influence of each variable and indirectly through intervening. By intervening in good corporate governance, the effect of using GCG is higher than not using GCG. This shows that GCG has a role in increasing ROA due to changes in LDR, NPL and CAR variables. This means that if a bank wants to increase profits, not only loans, bad loans and capital should be considered, but the Good Corporate Government must also be maintained.

V. CONCLUSION

Based on the results of statistical tests obtained after data collection, data processing, hypothesis testing, and analysis and discussion related to the research hypothesis, the researcher draws the conclusions as follows:

1. Simultaneously the variable loan to deposit, non-performing loans, capital adequacy ratio have significant effect to good corporate governance.
2. Through intervening good corporate governance variables, simultaneously the non-performing loans, capital adequacy ratio, good corporate governance have a significant effect on return on assets. Partially,

non-performing loans, capital adequacy ratios, good corporate governance have an influence on asset returns, But the loan to deposit does not have a significant effect.

VI. RECOMMENDATION

Based on the results of research and discussion, there are several suggestions that can be given, including:

1. For the management of banking companies to be prudent in managing funds and liquidity in accordance with the principles of good corporate governance. Companies that manage policies in managing liquidity in accordance with applicable banking regulations and principles of good corporate governance (ALMA).
2. For the public, investors or potential investors, to be more careful in analyzing the factors that influence return on assets. In seeing the effect of variables on return on assets, it is better to include good corporate governance (GCG) as an intervening variable. Considering that GCG will increasingly look at the effect of each variable on ROA. Thus increasing the decision taken. This research has provided evidence.
3. For future researchers, it is better to add an analysis of the influence of other variables not used in this study for better results.

References

- Ari, Anjani Luh Putu ., Yadnya, I Putu . 2017. Pengaruh *Good Corporate Governance* terhadap profitabilitas pada perusahaan perbankan yang terdaftar di BEI. E-Jurnal Manajemen Universitas Udayana. Volume 5 Tahun 2017.
- Auliya, Rizka. 2014. Pengaruh *risk, Good Corporate governance, earning* dan *capital* terhadap profitabilitas pada bank umum swasta nasional devisa di Indonesia. STIE Perbanas Surabaya.
- Bernardin Deden Edwar Yokeu. 2016. Pengaruh *Capital Adequacy Ratio dan Loan to Deposit Ratio* terhadap *Return on assets*. E-Journal Ekonomi dan Bisnis Universitas Bina Sarana Informatika. Volume 4 Nomor 2 Tahun 2016.
- Budi, Ni Luh Putu., Wiagustini, dan Ida Bagus. 2017. Pengaruh kecukupan modal dan risiko kredit terhadap profitabilitas likuiditas sebagai pemediasi pada bank perkreditan rakyat di kabupaten badung. E-Jurnal Ekonomi dan Bisnis Universitas Udayana. Volume 6 Nomor 6 Tahun 2017.
- Dewi, Ni Kadek Venimas, Wayan Cipta, dan I Ketut Kirya. 2015. Pengaruh LDR, LAR, DER dan CR Terhadap ROA. E- Journal Bisma Universitas Pendidikan Ganesha Jurusan Manajemen. Volume 3 Tahun 2015.
- Frisca, Frisilia., Raisa Pratiwi. 2014. Pengaruh *Good corporate governance*, Likuiditas dan ukuran perusahaan terhadap profitabilitas pada Perusahaan BUMN yang termasuk dalam IICG dengan struktur modal sebagai variabel intervening. STIE Multi Data Palembang.
- Hevy, Komang. 2019. Pengaruh *Good Corporate Governance* terhadap Profitabilitas Perbankan dengan Risiko Kredit sebagai Variabel Intervening (Pada Perbankan yang Terdaftar di BEI Periode 2014 -2016). Universitas Mataram. (e-ISSN: 2477-1767:vol7.no1- Maret-2019).
- Ika Permatasari, Retno Novitasary. 2013. Pengaruh Implementasi *Good Corporate Governance* terhadap Permodalan dan Kinerja Perbankan di Indonesia Manajemen Risiko sebagai Variabel Intervening. Universitas Negeri Surabaya.
- Indah Dwi, Arief. 2015. Pengaruh Non Performing Loan (NPL) dan Capital Adequacy Ratio (CAR) terhadap profitabilitas. Universitas Negeri Semarang.
- Kisman, Z. Model for Overcoming Decline in Credit Growth (Case Study of Indonesia With Time Series Data 2012m1-2016m12). Journal of internet Banking and Commerce. Vol.22,2017.
- Kiswanto dan Asri Purwanti. 2016. Pengaruh Tingkat Kesehatan Bank menurut Risk Based Rating terhadap Kinerja Keuangan dengan *Good Corporate Governance* sebagai Variabel Intervening pada umum Syariah dan Unit Usaha Syariah di Indonesia. E-Jurnal Akuntansi Indonesia Universitas Unissula, Vol.5 No.1 2016.
- Permatasari Ayu Nur, Dadan Rahadian dan Irni Yunita. 2017. Pengaruh CAR, LDR, BOPO, NPL dan Ukuran Perusahaan terhadap Profitabilitas (Studi Kasus pada Bank Umum Swasta dan Bank Devisa di Indonesia periode 2012 -2015). E-Proceeding of Management Universitas Telkom: Vol.4 No.2 2017.
- Pedoman Umum Good Corporate Governance Indonesia 2006.*
- Peraturan Bank Indonesia Nomor : 13/1/PBI/2011 tentang Penilaian Tingkat Kesehatan Bank Umum.
- Peraturan BI No. 8/14/PBI/2006 tentang Pelaksanaan *Good Corporate Governance* bagi Bank Umum.
- Prinsip Dasar Pedoman *Good Corporate Governance* Perbankan Indonesia, diterbitkan oleh Komite Nasional Kebijakan Governance

- Restiyana. 2011. Analisis pengaruh CAR, NPL, BOPO, LDR, dan NIM terhadap Profitabilitas Perbankan. Universitas Diponegoro Semarang.
- Riski Agustiningrum. 2018. Pengaruh antara *Capital Adequacy Ratio* (CAR), *Non performing Loan* (NPL), *Loan to Deposits Ratio* (LDR). E-Jurnal Manajemen Universitas Udayana. Volume 2 Nomor 8 Tahun 2018.
- Sandra, Kurniawati, Zilal Hamzah, dan Tri Kunawangsih. (2018). Analisis Pengaruh CAR, LDR, DER, BI Rate dan Inflasi Terhadap ROA Pada 10 Bank Besar di Bursa Efek Indonesia. Seminar Nasional Cendekiawan 4 Tahun 2018.
- SE BI No. 13/24/DPND petunjuk pelaksanaan Peraturan BI No. 13/I/PBI.2011 25 Oktober 2011 Penilaian Tingkat kesehatan Bank Umum.
- Sri Wahyuni Rasyid. 2012. Analisis Pengaruh Loan to Deposit ratio (LDR) Net interest margin (NIM) dan efisiensi terhadap return on assets (ROA) Bank Umum Indonesia. Universitas Hasanuddin.
- Otoritas Jasa Keuangan, Booklet Perbankan Indonesia 2014. ISSN : 1858-4233 Departemen Perizinan dan Informasi Perbankan, , Edisi 1, Maret 2014.



Human Resources Management Practices and Total Quality Management (TQM) is the Precondition to Gain the Sustainable Competitive Advantage in the Bangladesh Ready-Made Garments Sector

Farhana Rashid¹, Che Azlan Taib², Rushami Zien Yusoff³, Mohd Akhir Hj. Ahmad⁴

¹ School of Technology Management and Logistics, Universiti Utara Malaysia, Malaysia United International University, Bangladesh. Email: farhana_rashid@oya.uum.edu.my

² School of Technology Management and Logistics, Universiti Utara Malaysia, Malaysia. Email: c.azlan@uum.edu.my

³ College of Business, Universiti Utara Malaysia, Malaysia. Email: rzy278@uum.edu.my

⁴ School of Technology Management and Logistics, Universiti Utara Malaysia, Malaysia. Email: makhir@uum.edu.my

Abstract

Bangladesh Garments manufacturing industry is expanding at a rate of 20% per year and around 76% of the export earnings are came from RMG sector (BEPB, 2018). Currently 4.2 million workers are working in this sector where 4490 manufacturing units are in operation (BGMEA, 2018). Bangladesh Ready-Made Garments (RMG) shows remarkable growth and significant contribution in the country's economic development though product and service qualities are yet a considerable problem to worry about. RMG companies in Bangladesh are not fully aware about the impacts and value of Total Quality Management (TQM) implementation. At the same time, Bangladesh garments industry fully labor intensive rather than technology oriented as Bangladesh is the cheapest labor country, the average labor cost per hour is only \$0.3. Researchers argue that effective implementation of HRM and TQM practices is a main criteria and predictor of gaining sustainability in business. As, it is notable to mention that in case of Bangladesh RMG sector most of the existing literature give more emphasis and discuss about the infrastructural and strategic matters whereas TQM and Human Resource Management (HRM) practices in an attempt to improve sustainable competitive advantage is still a debate both theoretically as well as empirically. In this research tried to point out that HRM practices and TQM are positively related to organizational sustainable competitive advantage. In this aspect, literatures proved that, HR practices didn't get much attention which need to be measured and analysis in the aspect of Bangladesh RMG sectors quality performance improvement as in RMG sector human resources is the main advantage for industrial growth and sustainable competitive advantage in business. So this study is required to lift up this expectation to fulfill this research gap So there is a huge gap for further research. Proposed research direction and conclusion are discussed in conclusion of this research.

Keywords: Total Quality Management, Sustainable Competitive Advantage, Human Resource Management practices, RM

INTRODUCTION

Cost of poor quality of Bangladesh ready-made garments amounted to 18 percent of the operating costs (BGMEA, 2018). The RMG industry has been Bangladesh's key export industry and a main source of foreign exchange for the last 25 years though poor quality of products and services are considerable factor for the development of this sector.

Meanwhile the apparel sector, all the Bangladeshi garment companies are producing at the low end of the market (Rahman and Masud, 2011). Basically they are performing cutting, making and trimming (CMT) activities (Abdullah and Yusuf, 2008; Johir, Saha, and Hassan, 2014). Therefore, this industry takes maximum lead time to process an order (Yunus and Yamagata, 2012). According to Rahman and Anwar (2011) in Bangladesh the lead time for apparel export varies between 90-120 days, whereas the time for Sri-Lanka is about 19-45 days, China 40-50 days and for India 50-70 days for similar products.

Cost of poor quality of Bangladesh ready-made garments amounted to 18 percent of the operating costs (BGMEA, 2015). In this regard, Sharmin Akhter (2014) stated that the theory of quality management is new in Bangladesh RMG sector and the state is in a limited understanding condition. In contrast of few organizations that have adopted quality management practices have experienced an overall improvement in corporate performance (Rahman, 2010). However, according to Mamun and Islam (2012) in nearly all cases, TQM organizations achieved better employee relations, higher productivity, better customer satisfaction, increased market share and improved profitability. According to Sharmin Akhter (2014) little research has been conducted in TQM practices area in Bangladesh Ready-Made Garments sector. According to Jha and Joshi (2010) in today's global competition and economic liberalization, quality has been considered as an important factor for achieving competitive advantage. In case of Bangladesh Ready-made Garments companies, rather than take the whole process, most local authorities narrowed down their quality approach to few operations in order to cut cost (Sawhel, 2012). TQM practices is always the most neglected field of research in case of Bangladesh RMG sector as very few research have been conducted in this area (Rahman and Masud, 2011; Ferdousi and Shabnam, 2013). So there is an unsolved and emerging research argument in the field of TQM practices in Bangladesh RMG sector is yet need to be answered. However, many garments companies in Bangladesh don't have full knowledge and awareness about the effective implementation of TQM practices whereas they only use and stressed on ISO 9000 which sometimes cause problems (Shareef, Vinod and Kumar 2008; Ariful, Nasima and Rashed, 2012). In this regard, according to Sohail and Teo (2003) the certification of ISO 9000 is the initial step of TQM implementation though survey shows that few researchers stressed only on total quality management practices exclusively. Heras et al. (2012) also verified the result of these studies. So their study concluded with the view that the application of ISO 9000 concept is primary initiative and TQM is contribute further towards the development and ensure organizational quality performance. As Bangladesh RMG sector is now only used ISO 9000 which need to transformed and transit to TQM implementation. So this research will help to explore this research gap.

On the other hand, according to Seddiqe and Basak (2014) Human Resource is the most important asset for Ready-made Garments industry in Bangladesh. Bangladesh RMG sector should focus on proper implementation of HR policies to emphasis quality performance (Absar and Mahmood, 2014). As each organizations success and quality goal accomplishment is largely depends upon the capabilities of human resources (Budhwar and Debrah, 2011). In this regard according to Rahman (2012) against technological scenery, a thorough analysis of human resource management practices on manufacturing industries especially on Bangladesh RMG sector is very much needed. HRM practices are immensely necessary for the achievement and ensuring quality performance in the organization. It is not secondary rather an crucial and major elements for the implementation of TQM practices (Abbas, 2012). TQM studies related to HR practices can be found in the operations management literature but paid little attention to human resources issues towards gaining sustainable competitive advantage (Shahi, Faisal and Aftab, 2014; Issac et al., 2014). According to Alsuhaيمي (2012) indirect effects (mediation) of HRM have been neglected in most empirical research specifically in quality management area. These issues are more significant in Bangladesh RMG sector as never tested the mediating role of HRM practices in the aspect of TQM and sustainable competitive advantage (Ferdousi and Shabnam, 2013). So there is a huge research gap in this area which needs to justify further.

However, Bangladesh has reached and gains a remarkable development especially in inexpensive workforce context of RMG sector still its development and continuity of growth is not assured (Adhikari and Weeratunge, 2007). In this respect, according to Fasil and Osada (2011) TQM practices are the precondition for the continuous development of business to cope up with the current competitive market and globalization. For identifying the need of TQM practices in Bangladesh RMG sector, it already focused and start working on using quality control issues but unfortunately due to structural difficulties and inflexible hierarchical difficulties quality goals not achieved (Sharmin Akhter, 2014). So, the defining role of TQM implementation in predicting to gain sustainable competitive advantage in Bangladesh RMG context is required (Lee, 2012). Hence, the purpose of this study is to generate research idea for investigation the potential link and association of TQM practices in Bangladesh RMG sector to gain sustainable competitive advantage mediated by Human Resource Management practices.

SIGNIFICANCE OF THE STUDY

To promote and facilitate TQM adaptation in RMG sector in Bangladesh, this research result will contribute significantly. The levels of service offered by ready-made garments companies in Bangladesh were not always acceptable to customers. However, this study is immensely significant for Bangladesh Ready-Made garments companies as for the growing competition, imposition of various new rules and regulations in global business context. The necessity of this research can be justified. One, almost every organization need to develop a quality environment to ensure the quality performance. Two, the purpose of the organizations are mainly to variegate the competitive market as well as boost up the export and revenue through quality performance. Three, to cope up with the changing market condition and ensuring quality performance, organizations need to involve every employee as well as gain commitment. Four, ensuring customer satisfaction is the precondition of business success and sustainability. Five, the importance of group work and an interdisciplinary research was firmly recommended. As well as the findings of this study will be useful to government and other organizations in Bangladesh that are currently implementing TQM practices, as well as those seeking to establish TQM practices within their systems with the aim of improving performance as well as gaining sustainable competitive advantage of their businesses (Chowdhury, Ahmed, & Yasmin, 2014). The current study offers significant values for practitioners since it has considerable managerial significance. At the same time, this research will be significant in Bangladesh garments sector by offering new insights into the various TQM as well as HRM functions. The results of the study will enable buyers as well as customers to buy products from Bangladesh without worrying about the quality standard of products and services. Clearly, theoretical contribution of this study is significant because the research model will form theoretical and practical variables to relate TQM, HRM practices and sustainable competitive advantage. These initiatives will cover the latest research gap on the implementation of TQM, HRM as well as gaining sustainability in the literature. Additionally, it is believed that this study can be replicated in other context such as other product and service industries in Bangladesh. Therefore, this study will assist and explore for future research prosperities and opportunities in TQM area of research. Another relevance of this study is to serve as a guide for researchers who focus on quality management to strategize and help maintain competitive advantage of a given government through implementation of TQM practices (Fahmida Khatun, 2015). Overall, this research can help to build up remarkable understanding of practicing TQM in Bangladesh RMG sector as well as contribute significantly in building the scientific knowledge in the subject of the research area.

LITERATURE REVIEW

Human Resource Management

Generally, Human resource management (HRM) is the governance of an organization's employees. Absar (2014) denoted that due to lack of proper HR policies and procedures, labour-intensive manufacturing firms are facing shortage of workers, and high job turnover in developing countries such as Bangladesh. Shahin and Basak (2014) stated that Human Resource is the most important asset for Ready-made Garments industry in Bangladesh for implementing TQM properly. In Bangladesh context very few researchers have been conducted though the importance of HRM practices are immensely important for organizational development, growth and sustainability (Ahamed, 2013). In this regard according to Hossan, Rahman and Rumana (2012) there is a rapid growth of industrialization in Bangladesh, yet, the realities for Bangladesh RMG sector is that their people remain

undervalued, under trained and underutilized. So the potential growth and prospect in Bangladesh RMG sector is huge. And for using this opportunities it should focused on proper implementation of HR policies to emphasis quality performance (Weeratunga, 2003; Absar & Mahmood, 2014).

Pfeffer (1994) introduced 16 HR practices which denote best practice. In context of Bangladesh ready- made garments industry and TQM implementation, in this research we consider the following four practices: recruitment and selection, job analysis, manpower planning, equal employment opportunity act (EEOA).

The main focus of recruitment and selection process is the choosing the right person for the right position. According to Mládková (2005), "workers must be able and willing to cooperate and communicate and accept the way of sharing their knowledge (skills, abilities and experience) based on reciprocity, reputation and altruism." Schuler (1987) give emphasised in his study on more general, implicit and less formalised selection criteria are proposed by some authors. In Bangladesh ready-made garments, they don't follow any defined recruitment and selection policies which largely affect employees' turnover and competitiveness (Ahamed, 2013). On the other hand, Geisler stated that, "manpower planning is the process – including forecasting, developing and controlling by which a firm ensures that it has- the right number of people, the right kind of people, at the right places, at the right time, doing work for which they are economically most useful." Manpower planning is associated with organizational optimum size of workforce, appropriate training design, compensation system design as well as the future vision of the workforce management which are highly recommended in case of TQM practices in Bangladesh RMG sector (Ahamed, 2013). According to Bansari (2010), "most garments factories in Bangladesh pay little attention to labour standards and labour rights, disallow trade union activities, unsafe working environment, and ineffective laws and discard fair labour practices, and compliance enforcement is limited and limited role of stakeholders." According to Ahamed, F. (2011), "there is a rising fear in Bangladesh that the readymade garments sector may face a decline in demand and social compliance in the RMG industry is a key requirement for most of the world's garments buyers which ensures labour rights, labour standards, fair labour practices and a Code of Conduct."

So for ensuring quality practices and gaining sustainability in RMG sector of Bangladesh much attention should be given to EEO approach to avoid labor unrest and lack of quality performance. Job analysis is required huge impact for starting to implement any HR practices in organization (Sharmin, 2014). According to Cascio (1991) for evaluating the organizational performance effectively job analysis also associated with performance management and compensation, recognition and reward. Therefore, according to Dobbins et al. (1991), individual skills and competencies are focused in job analysis which is needed for empowering employees which is essentially significant in case of TQM implementation. Lastly, According to Shahin and Basak (2014) measuring job fitness is also a part of job analysis process which includes change management, job classification, creativity, and job design and job rotation. In this research, job analysis requires more significant attention in context of Bangladesh ready-made garments industry to gain sustainable competitive advantage for implementing TQM.

Therefore, according to Absar (2014) HRM practices were not given proper acknowledgements and preferences in aspect of Bangladesh RMG sector. So based on literature it is easily understandable that HR practices didn't get much attention which need to be measured and analysis in the aspect of Bangladesh RMG sectors quality performance improvement as in RMG sector human resources is the main advantage for industrial growth and sustainability in business. So this study is required to lift up this expectation to fulfil this research gap.

Total Quality Management

For defining quality there is no unison. Various researchers define the concept of quality in various ways. Quality Gurus defined quality and total quality management in numerous ways, such as, Deming, Crosby, Juran, Garvin, Feigenbaum and Ishikawa etc. every one gave various types of definition. Garvins definition was very remarkable; he defined quality in respect of industry based, usage based, service and product based, theoretical based, customer based approaches. Eight attributes of measuring service and product quality is also mentioned by him (Garvin, 1987). According Juran quality is "fitness for use." Planning of quality, control of quality as well as quality

improvement is the quality trilogy which was also mentioned by Juran. According to Crosby, "quality is the conformance to requirements or specifications and requirements are based on customer needs."

Zero defect quality improvement plans to achieve performance improvement which consist 14 steps also mentioned by Crosby (Kruger, 2001). Deming defined, "quality is a predictable degree of uniformity and dependability, at low cost and suited to the market". To enhance and ensure the performance as well as productivity, Deming also mentioned 14 quality management principles. To improve organizational performance Ishikawa insist on the importance of total quality control. Ishikawa diagram (the fish bone diagram), the cause and effect diagram is also Ishikawa's contribution to identify quality issues and problems (Kruger, 2001). Feigenbaum denoted the ideas and views of organization wise total quality control. And most interestingly he was the initial user of the concept of total quality control in the literatures of quality aspect. According to Feigenbaum, "quality is the total composite product and service characteristics of marketing, engineering, manufacturing and maintenance through which the product and service in use will meet the expectations by the customer" (Kruger, 2001). The significant elements of these quality development concepts consists commitment of management, strategic quality system approach, measurement of quality, improvement of process, training and development and reducing the various symptoms and reasons of problematic incidents. TQM always give emphasis on customer satisfaction to ensure quality culture by using continuous improvement concept. According to Kanji and Wallace (2000), "this culture varies both from one country to another and between different industries, but has certain essential principles which can be implemented to secure greater market share, increased profits, and reduced costs."

Rao et. al (1996) illogically, TQM should be the set of practices that enable an organization to deliver quality products or services.

TQM defined as ...

- The way of managing organization to achieve excellence
- Total – everything
- Quality - degree of excellence
- Management – art, act of way of organizing, controlling, planning, directing to achieve certain goals

According to BS4778:1991, TQM is a management philosophy embracing all activities through which the needs and expectations of the CUSTOMER and COMMUNITY, and the objectives of the organization are satisfied in the most efficient and cost effective manner by maximising the potential of ALL employees in a continuing drive for improvement."

However, According to Zairi and Youssef (1995), "management awareness of the importance of total quality management, alongside business process reengineering and other continuous improvement techniques was stimulated by the benchmarking movement to seek study, implement and improve on best practices." Originally management commitment and continuous improvement was developed in aspect of using in manufacturing industries though later service sector also included in the usage categories, such as use teller transactions in case of bank's service, processing order in various catalog organizations, etc.). Therefore, to identify various critical factors for TQM, many researches were conducted as well as lots of identified by many researchers as well as academicians and organizations such as "Malcolm Baldrige Award, EFQM (European Foundation for Quality Management), and the Deming Prize Criteria". On the basis of these researches, a vast majority of managerial concepts, tools, methods, process and strategic system have been developed. For measuring the organizational performance Saraph et al. (1989) identified and mentioned 78 items that were categorized in to eight critical factors of TQM. These are: "Role of divisional top management and quality policy, role of the quality department, training, product and service design, supplier quality management, process management, quality data and reporting, and employee relations." Other researchers Flynn et al. (1994), suggested other tools to identify major critical factors of TQM. They mentioned seven factors of quality. These are "top management support, quality information, process management, product design, workforce management, supplier involvement, and customer involvement." It's mentionable that Saraph et al. and Flynn et al., their recommended elements are quite identical. Flynn et al.

identified the influence of TQM practices in aspect of performance of quality and gaining competitive advantages of the organizations. In this regard, other significant study, Anderson et al. (1994) mentioned the basic concepts of TQM practices on the basis of Deming's 14 principles. By using the Delph technique they could able to reduce the number of elements from 37 to only 7. The elements are: "visionary leadership, internal and external cooperation, learning, process management, continuous improvement, employee fulfillment, and customer satisfaction." On the basis of the Malcolm Balridge Award measurement tools, Black and Porter (1996) suggested critical factors for TQM. Actually they formulated 32 elements which were categorized into 10 different categories of critical factors which are: "corporate quality culture, strategic quality management, quality improvement measurement systems, people and customer management, operational quality planning, external interface management, supplier partnerships, teamwork structures, customer satisfaction orientation, and communication of improvement information."

On the basis of thorough investigation of literatures Ahire et al. (1996) also recommended 12 elements to measure critical factors of TQM of firms. The 12 factors are: "supplier quality management, supplier performance, customer focus, statistical process control usage, benchmarking, internal quality information usage, employee involvement, employee training, design quality management, employee empowerment, product quality, and top management commitment." Motwani (2001) denoted, "TQM as constructing a house." Firstly, he considers top management commitment as the base line concept. For a better house construction of base line or foundation is essential. After that "employee training and empowerment, quality measurement and benchmarking, process management, and customer involvement and satisfaction" should be assured and placed. All these elements are considered as the basic four concepts of constructing a house. When the four concepts or pillars are developed properly then time to give emphasis on product manufacturing and design as well as service quality which are the end step of ensuring TQM practices of organization. In this regard, generally many researchers have been mentioned that the center of effective implementation and execution of TQM practices is top management commitment and capability to work as a visionary leader to cope up with the continuous changing and competitive market (Absar & Mahmood, 2011). Literatures also showed the necessity of training for the effective implementation of TQM practices (Palo & Padhi, 2003; Quazi, Hong, & Meng, 2002). In this respect, Wali, Deshmukh and Gupta (2003) also work on selecting TQM elements for organizational success. Though, their research work focused on quality gurus works only. In Bangladesh few researchers (Rahman and Masud, 2011; Alsuhaيمي, 2012; Parul Akhter, 2015) work haven been found which was concentrated only on the TQM elements which were proposed by Ahire, Golhar and Waller (1996) as well as they tried to relate it with Bangladeshi context.

In their research they mentioned twelve TQM elements which are responsible for Bangladeshi organizational success (Rahman and Masud, 2011; Alsuhaيمي, 2012; Parul Akhter, 2015). The twelve factors are: Innovation and leadership, employer and employee relationship, rewards and recognition, culture of the organization, Information system, concentration on customer related factor, issues related with ethics, channel of organizational communication, work Team, mutual respect among employees, employee empowerment, continuous improvement.

However, the commonality of concepts of quality and TQM of various researchers are hard to find. Suppose many researchers give emphasis on the "technical and programmatic properties of TQM," whereas another group of researchers pointed out "the general management philosophy." Many other researchers mentioned, "the holistic picture when formulating constructs of TQM (Saraph et al., 1989; Anderson et al., 1994; Flynn et al., 1994; Ahire et al., 1996; Black and Porter 1996; Motwani, 2001; Sila and Ebrahimpour, 2005; Demirbag et al., 2006)". Therefore, on the basis of the above literatures, it is easily concluded that the ideas and opinions of various researchers are not identical rather complementary to each other. And in this research more focused will be given on leadership and top management commitment, focus of customer, process approach, training & development, system approach, continuous improvement, reward and recognition and supplier relationship.

Sustainable Competitive Advantage

Sustainable competitive advantages are company assets, attributes, or abilities that are difficult to duplicate or exceed and provide a superior or favorable long term position over competitors. According to Bohoris (1995)

many organizations have already realized that their only way of surviving in today's competitive global market is to become a successful total quality organization. At the same time, Corbett and Rastrick (2000) stated that there is significant association between TQM activities and organizational competitiveness. Several other researchers support the findings of this study (Shabbir et al, 2010). All these elements associated with sustainability which could achieve through successful quality implementation. According to Fasil and Osada (2011) Total Quality Management is a buzzword for the organizations to safeguard their growth and sustainability in today's strongly competitive and turbulent global scenario.

Currently garments sectors financial performance is satisfactory but to gain the long term sustainability and competitiveness need to focus on TQM practices (Rahman, 2011). According to Zineldin (2006) RMG sector needs to retain its customers by providing excellent quality services with minimum or no defects to gain sustainability. So, the defining role of TQM implementation in predicting to gain sustainable competitive advantage in Bangladesh RMG context is required (Akhter, 2015). According to Pinho (2008) in the global market, for gaining sustainability practices of TQM received proper attention and acknowledgement. Kanji (2001) stated that, "organizations need a framework that is comprehensive, flexible and easy to adopt and help to gain sustainability." According to Talib et al. (2010), "the reasons being only to help industries improved its efficiency and competitiveness through quality improvement." TQM practices enhance the whole organizational communication system which is highly required for quality performance in the current business world (Lee, 2012). Drew and Healy (2006) stated that, "TQM allows firms to obtain a high degree of differentiation, satisfying customer needs and strengthening the brand image, and also acts as a tool to reduce costs by preventing mistakes and time wastage, while it allows improvement in the corporation processes." Sila and Ebrahimpour (2003) also had given emphasis on conducting research on TQM elements in aspect of various countries as well as various industries. For sustainability cost reduction as well as product and service differentiation is required which can be achieved through TQM practices (Sharma & Kodali, 2008).

In this research organizational performance selected as the part of gaining sustainable competitive advantage in Bangladesh RMG sector. According to Li et al. (2006) organizational performance refers to how well an organization achieves its market-oriented goals as well as its financial goals. In this regard, Stock et al. (2010) mentioned that a number of prior studies have measured organizational performance using both financial and market criteria, including return on investment (ROI), market share, profit margin on sales, the growth of ROI, the growth of sales, and the growth of market share. In this research long term performance is focused which is related with organizational long-term sustainability. According to Terziovski (2006) TQM is the source of sustainable competitive advantage for business organizations. Teh et al. (2009) stated that TQM work as a source of enhancing organizational performance through continuous improvement in organization's activities. At the same time, much research had been conducted to define the relationship among TQM and innovation (Prajogo & Brown, 2004). The relation between TQM and innovation also need to be considered in aspect of gaining Bangladesh RMG sectors sustainable competitive advantage which is focused in this study.

The effect of TQM practices on gaining sustainable competitive advantage in context of Bangladesh ready-made garments industry should be select for further research which will done in this research as there is a huge research gap for it. In this Regard, according to Dean and Bowen (2014) the recognition of TQM as a competitive advantage is widespread around the world, especially in Western countries, and today very few companies especially manufacturing companies can afford to ignore the term TQM. Therefore, according to Issac et al. (2014) TQM has been widely considered as management tool for business stability, growth and prosperity as a tool to keep competitive advantage. In this regard, Dale and Plunkett (1995) stated that for last two decades, quality has been considered as one of important factor in manufacturing, service and purchasing to increase sales and profits. There is an inconsistency of research result of these studies and worthy to examine as research gap. According to Lewis et al. (2006) the relationship is not so clear when the TQM concept is divided into different dimensions and those dimensions are evaluated for their separate effect.

PROPOSED FRAMEWORK

According to Li et al. (2012) TQM practices enhance the whole organizational communication system which is highly required for quality performance in the current business world. Recent research proves that Bangladesh RMG sector faces some serious quality issues that have largely influenced the growth rate of this sector (Haque et al., 2011; Ariful, Nasima and Rashed, 2012). Over the last three decades, there has been a growing interest in Total Quality Management (TQM) as a strategy that is capable of offering organizations a competitive advantage (Reinhardt & Gurtner, 2014). Currently RMG's are facing immense global competition (Heras et al. (2012)). TQM is one of the most widely used operation management practices which most of the developed countries already adopted (Jung & Wang, 2006; Johir, Saha & Hassan, 2014). Whereas, According to BGMEA (2014) the quality of products and services of Bangladesh ready-made garments are a vital issue to concern. RMG can charge high prices as well as increase their profit if they can ensure about their quality operation of product and service delivery (Ariful, Nasima, & Rashed, 2012; Yunus & Yamagata, 2012).

Many organizations have already realized that their only way of surviving in today's competitive global market is to become a successful "total quality organization" (Alsuhami, 2012). Empirically, In the aspect of Bangladesh garments manufacturing industry a TQM approach unique to the needs and culture of the organization must be developed (Rahman & Masud, 2011; Johir, Saha & Hassan, 2014). At the same time, Absar and Mahmood (2012) stated that in the context of TQM, the extent to which HR departments undertake and support organizational sustainability competitive advantage have been examined and seriously questioned. In the current Bangladesh RMG context, HRM researchers paid much attention on TQM practices and implementation in case of organizational profitability (Absar & Mahmood 2012; Parul Akhter 2015. Literatures suggest that, several TQM practices help organization to gain sustainable competitive advantage, specially, developing country like Bangladesh ready-made garments industry(Bansari, N., 2010; Ahamed, F., 2011).Hence, the following framework is put forward (Figure: 1)

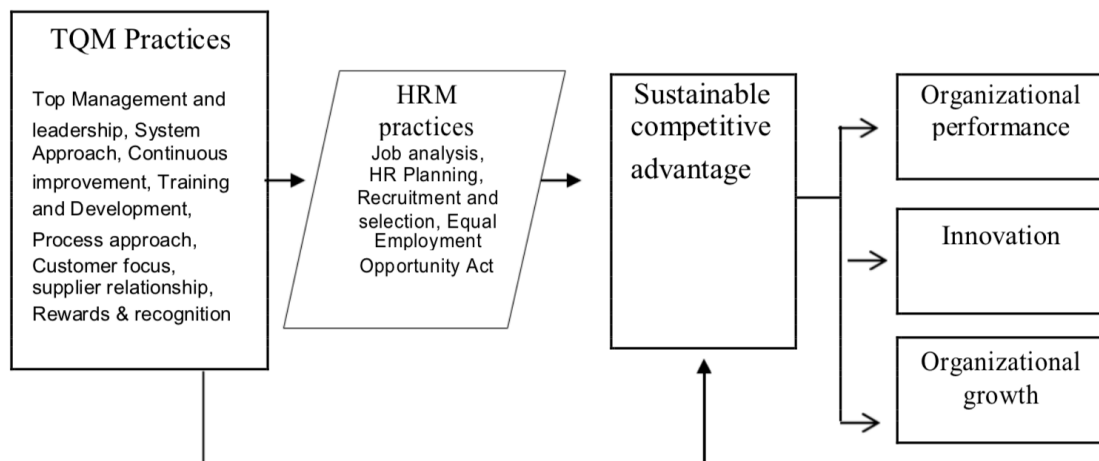

Figure 1: Proposed Research Framework

Based on the Figure 1, HRM practices will influence or alter the value of link among IV and DV. The IV (Independent Variable) is consists of eight TQM practices such as leadership and top management commitment, customer focus, process approach, system approach, training and development, continuous improvement, supplier relationship, reward and recognition. HRM practices work as mediator which consists four practices. The four functions are: Selection and recruitment, job analysis, manpower planning and equal employment opportunity (EEO) will help to build up the efficient workforce. And lastly, the DV (Dependent Variable) is the sustainable competitive advantage which consists of three criterions to measure, such as organizational performance, innovation and organizational growth in the context of Bangladesh Ready-made Garments industry. DV and IV relation or association will be influenced by the levels of mediator, either strong or weak. In few circumstances,

the relation will be either positive or negative depends on the level of mediator. So the impact of mediator will be considerable in aspect of defining the condition of IV and DV.

PROPOSITION TESTING

This part explains how the relationship among variables will be managed and how hypotheses developed and tested. Hypothesis tests, or tests for statistical significance, require a number of elements. Before going further, the proper terminologies such as null and alternative, distribution data, critical value, confidence level, two-tailed or one-tailed test and errors should need to be considered. From the purposed framework, null hypothesis can be generated. A null hypothesis is a claim made, a belief expressed, a statistic is held to be the norm. The proposed framework assigned Human Resources Practices as a mediator variable. Based on the literature reviewed in the previous section, therefore these hypotheses are formulated:

H1: Total Quality Management practices are positively associated with Human Resource Management practices.

H2: Total quality management practices are positively associated with sustainable competitive advantage.

H3: Total quality management practices are negatively associated with sustainable competitive advantage.

H4: Human Resources practices are positively associated with sustainable competitive advantage.

In order to achieve the objectives of the study, according to Creswell (2009), there are mainly three approaches used as the process to collect data and information for the purpose of investigation certain issue; quantitative, qualitative, and mixed method. There is no right or wrong what approach researcher may choose. The important is related with the research paradigm. The research approach selection is based on the research problem. Thus, the research approaches, designs, and the methods represent a perspective about research that presents information in a successive way from broad constructions of research to the narrow procedures of methods (Creswell, 2009).

CONCLUSION

The performance and growth rate of Bangladesh RMG is diminishing. Current research shows various problems associated with the quality issues. However, the performances of Bangladesh RMG sectors are largely influenced by the international quality standard and regulations. By integrating the HRM practices literature into the TQM and organizational sustainable competitive advantage literature, this study do able to scientifically prove the practitioners of RMG sectors that the introduction of TQM is a compulsory step to gain a sustainable competitive advantage. Organizations worldwide have been exploring ways to improve business practices to gain competitive edge. The aim of this study was to test the impact of TQM practices on sustainable competitive advantage at ready-made garments companies in Bangladesh. TQM practices have positive and significant effect toward organizational sustainable competitive advantage. The question whether this proposed framework or model is valid and reliable to be answered if further investigation has been carried out. Henceforth, the examinations of each hypothesis and the subsequent empirical investigations of this study are crucial to validate the proposed research framework. It is expected that the study will be beneficial to local manufacturing players, policy makers, government and relevant practitioners.

References

- Ahamed, F. (2012). Improving Social compliance in Bangladesh's Ready-made Garment Industry. *Journal of Labour and Management in Development*, Vol 13. Retrieved from: <http://www.nla.gov.au/openpublish/index.php/lmd/article/viewFile/2269/3148>
- Akhter, Sharmin. (2014). Deming Management Method in the Readymade Garments Industry of Bangladesh. *Journal of Management*, Vol. 9(1), 178-189.
- Alsuhaimi, M. R. (2012). The Implementation of Total Quality Management in King Saud University. *International Journal of Independent Research and Studies-IJIRS*, Vol. 1(2), 84-88. Ahamed, F.
- (2013). Could monitoring and surveillance be useful to establish social compliance in the ready-made garment (RMG) industry of Bangladesh? *International Journal of Management and Business Studies*, Vol. 3 (3), 088-100.

- Ariful M. I., & Anwarul Haque, A.F.M. (2012). Key aspects of TQM implementation in manufacturing organization- an empirical investigation. *International Journal of Research in Management & Technology (IJRMT)*, ISSN: 2249-9563, Vol. 2 No. 3.
- Alireza Anvari, Yusof Ismail & Seyed Mohammad Hossein Hojjati (2011). A Study on Total Quality Management and Lean Manufacturing: Through Lean Thinking Approach. *World Applied Sciences Journal*, 12 (9): 1585-1596.
- Bangladesh Bureau of Statistics. (2015). Statistical pocket book of Bangladesh. GOB. Dhaka. Government Printing Office.
- BKMEA. (2014). Export Performance of RMG of Bangladesh for 2011-12 and 2012-13. Annual Report of Bangladesh Knitwear Manufacturers and Export Association. Retrieved from <http://www.bkmea.com/facts-figures.html>
- Bangladesh Garment Manufacturers and Exporters Association. (2015). Annual Report of BGMEA. Retrieved from www.bgmea.com
- Calvo-Mora, Picón, A., Ruiz, C., & Cauzo, L. (2014). The Relationships between Soft-Hard TQM Factors and Key Business Results. *International Journal of Operations & Production Management*, Vol.34 (1), 115–143.
- Feng, M., Terziovski, M. & Samson, D. (2007). Relationship of ISO 9001: 2000 Quality System Certification with Operational and Business Performance: A Survey in Australia and New Zealand-based Manufacturing and Service Companies. *Journal of Manufacturing Technology Management*, Vol. 19 (1), 22–37.
- Fasil, T. & Osada, H. (2011). Multiple dimensions of TQM success in developing countries: an empirical study on Deming prize winners from India and Thailand. *International Journal of Innovation and Learning*, Vol. 9(2), 184-203.
- Gopal K Kanji, & Mike Asher (1996). 100 methods for TQM. Response Books, New Delhi. Hietschold, N., Reinhardt, R., & Gurtner, S. (2014). Measuring Critical Success Factors of TQM Implementation Successfully-a Systematic Literature Review. *International Journal of Production Research*. Retrieved from <http://dx.doi.org/10.1080/00207543.2014.918288>
- Harun, N. A., Rashid, A. A., & Alrazi, B. (2013). Measuring the Quality of Sustainability Disclosure among the Malaysian Commercial Banks. *World Applied Sciences Journal*, Vol. 28, 195–201. Ishikawa, K. (1985). *What is TQC. The Japanese way*. Englewood Cliffs, NJ: PrenticeHall.
- Islam, M.M., & Khan, A.M. (2013). Minimization of Reworks in Quality and Productivity Improvement in the Apparel Industry. *International Journal of Engineering and Applied Sciences*, 1(4), 147-165.
- Israfil Shahin Seddiq, & Avizit Basak. (2014). Importance of Human Resource Management and the Competitive Advantage: A Case Analysis on Basis of the Textile Industry of Bangladesh. *Global Journal of Management and Business Research: A Administration and Management*, Vol.14 (9), 93-115.
- Islam, Md. Ariful, & Haque, A.F.M. Anwarul. (2012). Pillars of TQM Implementation in Manufacturing Organization- An Empirical Study. *Journal of Research in International Business and Management*, Vol. 2(5), 128-141.
- Jahid, H. (2013). The Competitiveness of Ready Made Garments Industry of Bangladesh in Post MFA Era: How Does the Industry Behave to Face the Competitive Challenge. *British Journal of Economics, Management & Trade*, Vol. 3(3), 296-306.
- Juran, J.M. (1995). *A history of managing for quality: The evolution, trends and future direction of managing for quality*. Milwaukee, WI: ASQC Quality Press.
- Kim, D., Kumar, V., & Kumar, U. (2012). Relationship between quality management practices and innovation. *Journal of Operations Management*, Vol. 30, 295-315.
- Md. Ariful Islam, & Anwarul Haque, A.F.M. (2012). Key aspects of TQM implementation in manufacturing organization-an empirical investigation. *International Journal of Research in Management & Technology (IJRMT)*, Vol. 2(3), 268.
- Munim Joarder, Nurul Hossain, & M M Hakim. (2010). Post-MFA Performance of Bangladesh Apparel Sector. *International Review of Business Research Papers*, Volume 6(4), 134 – 144.
- Nurul Absar, & Monowar Mahmood (2011). New HRM Practices in the Public and Private Sector Industrial Enterprises of Bangladesh: A Comparative Assessment. *International Review of Business Research Papers*, Vol. 7(2), 118-136.
- Ooi, K. B. (2014). TQM Practices and Knowledge Management: A Multi-group Analysis of Constructs and Structural Invariance between the Manufacturing and Service Sectors. *Total Quality Management & Business Excellence*. doi:10.1080/14783363.2014.914642.
- Parul Akhter (2015). Key Factors of TQM Implementation in the Textile and RMG Industry: A Study of Some Textile and RMG Companies of Bangladesh. *IOSR Journal of Business and Management*, Volume 17(2), 26-37.

- Prajogo, D.I. (2005). The comparative analysis of TQM practices and quality performance between manufacturing and service firms. *International Journal of Service Industry Management*, Vol. 16(3), 217–228.
- Rahman, M. M., & Masud, A.K.M. (2011). Quality Improvement in Garments Industry Through TQM Approach. *International Conference on Mechanical Engineering (ICME2011) 18-20, Dhaka, Bangladesh*, pp.1 -2.
- Rahman, M. M., & Masud, A.K.M. (2011). Quality Improvement in Garments Industry Through TQM Approach. *Proceedings of the International Conference on Mechanical Engineering, ICME 11-RT- 044*.
- Rahman, M. M., & Masud, A. K. M. (2011). Quality Improvement in Garments Industry Through TQM Approaches. *Journal of Management*, Vol. 12(1), 111-119.
- Shah Johir Rayhan, Sajeeb Saha, & Mohammad Masudul Hassan (2014). Factors Affecting the Customer Buying Behavior in Relation to Readymade Garments in Bangladesh. *International Research Journal of Marketing*, Vol. 2(2), 36-42.
- Sila, I., & Ebrahimpour, M. (2003). Examination and Comparison of the Critical Factors of Total Quality Management (TQM) across Countries. *International Journal of Production Research*, Vol. 41 (2), 235–268.
- Sharif Ahmed, Syduzzaman, Mahbubor Rahman, Mazedul Islam, & Ahashan Habib (2014). Effect of Total Quality Management (TQM) on Employee Satisfaction in the Apparel Industries of Dhaka Division. *European Scientific Journal*, Vol. 22(7), 251-269.
- Shahid Mehmood, Faisal Qadeer, & Aftab Ahmad (2014). Relationship between TQM Dimensions and Organizational Performance. *Journal of Commerce and Social Sciences*, Vol. 8 (3), 662-679.
- Sila, I., & Ebrahimpour, M. (2005). Critical linkages among TQM factors and business results, *International Journal of Operations & Production Management*, Vol. 25 (11), 1123- 1155.
- Sadrul Huda, Nargis Akhtar, & Afsana Akhtar (2011). Employee's View on Job Satisfaction: A Study on Garments Industry in Bangladesh. *Indus Journal of Management & Social Sciences*, Vol. 5(1),1-9
- Sukhwinder, Singh. (2013). TQM: An Emerging Necessity for Small Scale Industry Sector. *Global Research analysis*, Vol. 2 (1), 136–137.
- Talib, F., Rahman, Z., & Qureshi, M. N. (2010). The Relationship Between total Quality Management and Quality Performance sin the Service Industry: A Theoretical Model. *International Journal of Business Management and Social Sciences*, Vol. 1(1), 113-128.
- Uddin, Md Abbas. (2012). Readymade Garments Industry of Bangladesh: How the Industry is Affect in Post MFA Period. Unpublished master's thesis, Curtin University of Technology, Perth, Australia.
- Yunus, M., & Yamagata, T. (2012). The Garment Industry in Bangladesh. Fukunishi (Ed.). *Dynamics of the Garment Industry in Low Income Countries: Experience of Asia and Africa (Interim Report)*. Chousaken Kyu, Huokokusho, IDE-JETRO



The Level of Adoption of the International Accounting Standard 34 (IAS 34.) : The Case of Bahrain Listed Companies

Dr. Abdulla A. Rahman Ali¹

¹ Assistant Professor, University of Bahrain, College of Business Administration, Department of Accounting, Kingdom of Bahrain. Email: Mohanad52@hotmail.com

Abstract

The purpose of this study to explore the level of adoption of the International Accounting Standard 34 (IAS 34) in the preparation of interim reports by listed companies on Bahrain Stock Exchange (BSE). The data used in this exploratory study were based largely on information already published in the interim financial reports that are available at Bahrain Stock Exchange and on the websites of the listed companies. Neither IAS 34, nor does the national accounting legislation in Bahrain require firms to prepare interim financial statements . However, as elsewhere around the globe, companies in Bahrain prepare interim financial reports in compliance with the IAS 34. Not least because it is required for a company to be listed on Bahrain Stock Exchange (BSE). In addition, in order to maintain investor confidence, listed companies often exert considerable effort to disclose all necessary information that shows their financial position and ability to continue as a going concern through preparing more timely, costly interim reports. The results of this exploration reveal that the listed companies actually comply with the requirements of IAS 34, regardless of the high cost involved.

Keywords: International Accounting Standard 34 (IAS, 34) Bahrain Stock Exchange (BSE), Interim Financial Report

Introduction

The function of accounting is to provide pertinent, reliable, and timely financial information for decision making by various users, including investors, creditors and government authorities. The information is often provided through annual financial statements (the balance sheet that shows the financial position of a firm at specific date (what it owns and what it owes), statement of income that shows the results of operation during a period, and statement of cash flows to provide information on cash position, which is difficult to obtain from the statement of financial position.

The financial statements are usually prepared on annual basis. However, in the current volatile and dynamic business environment, the demand for more frequent, up- to-date reporting has gained an increasing momentum. It is now widely claimed that annual reporting is not enough to assess the ever changing business environment. Indeed, in the US as early as 1933 -1934, the Securities and Exchange Commission (SEC), required listed

companies planning to issue securities on the stock exchange to provide up to date information for users both annual and interim. SEC requires that Form 10 Q, to be filed quarterly and form 10 K to be issued annually at year end. Equally Securities and Exchange Board of India (SEBI) issued guidelines on February 4, 2000, requiring the stock exchanges to amend their listing agreements requiring each company to furnish unaudited financial result on a quarterly basis. The SEBI further required each listed company to submit quarterly compliance report on corporate governance.

In effect, the need for frequent reporting has long been recognized, but only in June 1999, that IAS 34 was first issued, and amended in 2010, 2012, 2014.

An interim financial report is either complete or condensed set of financial statements that normally covers a period of less than a year, semiannual, quarter, or a month (IAS 34-4). According to (IAS 34.8 the statement has to be in a condensed form, which means that only headings and subtotals used in last annual financial statements are required (IAS 34.10), The statements often include statement of financial position, statement of comprehensive income, statement of cash flows, results of operations, statement of changes in equity, and selected explanatory notes. However, IAS 34 does not specify which entities must publish an interim financial report.

In Bahrain, the Commercial Companies Act (CCA- 1975), requires all limited liability companies to provide annual audited financial statements, (income statement, balance sheet, and Board of Directors' report on distribution of dividends). The CCA, 1975, does not require limited liabilities companies to follow a specific set of accounting standards. However, in 1993, the Ministry of Commerce and Agriculture advised the limited liabilities limited liabilities corporate companies to adopt IASs.

The Bahrain Stock Exchange (BSE), was established in 1987, but operations started only on 17 June 1989, with 28 listed companies. The Bahrain Stock Exchange (BSE), is an independent separate legal entity supervised by a Board of Directors, chaired by the Governor of the Central Bank of Bahrain. In 2010, the authorities issued a law to establish Bahrain Bourse (BHB) as a corporation under the 1975 Commercial Companies Act (CCA- 1975).m In 2017, the number of listed companies on the Bahrain Stock Exchange (Bahrain Bourse). Increased to 42. At present, there are 50 companies listed with a market capitalization of \$ 25.3 billion and 5 overseas listings. The Bahrain Bourse is currently a member of various regional and foreign organizations to enhance its operations, such as the Union of Arab Stock Exchanges, the Federation of Euro-Asian Stock Exchanges, the World Federation of Exchanges, the Africa & Middle East Depositories Association, and the Association of National Numbering Agencies.

As of 2015 foreigners are allowed to buy, own or sell bonds, units of mutual funds, and warrants of domestic joint-stock companies. Expatriates living in Bahrain are allowed to purchase, own, and/or trade up to 49% of a domestic joint-stock company's equities. However, an expatriate is not allowed to own more than 1% of a company's issued capital.

There are ten companies that are completely open to foreign investors: Arab Banking Corporation (ABC), Arab Insurance Group (ARIG), Ahli United Bank (AUB), Al Baraka Banking Group (BARKA), Bahrain Middle East Bank (BMB), Ithmaar Bank (ITHMR), Investcorp Bank (INVCORP), Bahrain Shamil Bank (SHAMIL), Al Salam Bank (SALAM), and TAIB Bank (TAIB).

Foreign security holders are legally entitled to reap all the benefits of the ownership of securities of domestic joint-stock companies. They have voting rights on all matters submitted for approval, and receive dividends and other distributions tax free. The sale and purchase of a security creates a binding contract on the part of the seller to deliver

Over the last two decades listed companies on Bahrain Stock Exchange almost doubled from 27 in 2,000 to 50 in 2018 with a market capitalization of more than \$ 53 billion and 5 overseas listings.

Literature Review

Literature survey reveals that very few number of studies were carried out on interim financial reporting in developing countries (Joshi and Bremser, 2003); Omar and Simon, 2011). This clearly indicates that interim financial reporting has not received the necessary attention in the developing world including Bahrain in the contrast to the enorous attention in Europe and the US.

Joshi and Bremser, (2003). suggest that the size of a company in the developing countries is a driving force to adopt IAS 34), and further claim that their findings could be generalized to other developing countries. Equally, other studies suggest that overall disclosure in interim reports is directly related to the size of the reporting firms (Rahman *et al.*, 2007; Schadewitz, 2010; Spasic and Dencic- Mihajlov, 2014). Further, Omar and Simon (2011) found that companies listed in Amman Stock Exchange (Jordan) age, and industry type, along with a few other variables, are factors determine disclosure in interim reports.

IFRS, however, does not require the preparation of interim financial statements. Paragraph 36 in IAS 1 Presentation of Financial Statements only requires that:

'An entity shall present a complete set of financial (including comparative information at least annually.'

Nonetheless, it must be stressed that interim reports are by no means designed to provide reasonable assurance or reliable financial information as compared to the annual reports. Not least because of the shortness of the time period, not audited financial information, and that interim financial reports are subject to management manipulation. Furthermore, the variation between seasons of some businesses, the allocations of cost and expenses among interim periods, may render the benefits of unaudited interim financial statements to be limited.

IAS 34 does not specify the entities that are required to publish interim financial statements, the frequency of interim reports, nor the length of time required to be released after each reporting date. However, the standard encourages, publicly-traded entities to provide interim financial reports

"at least as of the end of the first half of their financial year, no later than 60 days after the interim reporting date".

Accounting Standards (AS-25), on the other hand, assert that ‘

"Timely and reliable interim financial reporting improves the ability of investors, creditors and others to understand an enterprise's capacity, to generate earnings and cash flows, its financial condition and liquidity."

An interim financial report may contain either a complete or condensed set of financial statements for a period less than a year. IAS 34.8 defines condensed to include only headings and subtotals used in last annual financial statements are required (IAS 34.10).,According to IAS 34 the minimum content requirement for the interim financial report is a condensed balance sheet, condensed income statement, condensed cash flow statement, condensed statements showing changes in equity, and selected explanatory notes. IAS 34 also requires an enterprise to apply the same accounting policies in its interim financial report as are applied in its annual financial statements. The accounting policy changes subsequent to the date of the most recent annual financial statements that will be reflected only in the next annual financial statements. The frequency of an enterprise's reporting annual, semiannually, or quarterly should not affect the measurement of its annual results. To achieve that objective, measurements for interim reporting purposes are made on a year-to-date basis, w3hich poses a serious challenge for practitioners, in particular in dynamic economy.

FASB summarized the following objectives and uses for interim reporting to:

1. *estimate annual earnings.*
2. *make projections.*
3. *identify turning points.*
4. *evaluate management performance.*
5. *supplement the annual report.*

Nevertheless, despite its well-recognized advantages, interim reporting faces serious drawbacks.

1. Inventory Problems

For a commercial enterprise, inventory is a major current asset that directly affect working capital and generation of income. Interim reporting faces three different inventory problems, namely: quantity of inventory, valuation of inventories, and adjustments of valuation. Determination of inventory quantity depends largely on physical counts. However, physical counts are often taken on annual basis. Not least, because physical inventory counts are time consuming, daunting business. which hinders inventory count quarterly or monthly prohibitive Inventory valuation, on the other hand, depends on inventory flow assumption. Various inventory valuation methods are accepted by both GAAP and IFRS, namely FIFO, LIFO, average, and specific identification. However, each of these methods produces different inventory value, different cost of goods sold and consequently different income figure. Further, the use LIFO during inflationary periods often poses serious problems in particular in developing countries.

2. Matching Problem

There are two accounting bases, accrual and cash bases. Both GAAP and IFRS prefer the accrual basis of accounting rather than the cash basis. Under the accrual basis, cash receipts from customers do not necessarily occur in the same period in which a firm recognizes revenues. Equally, cash payments to employees, suppliers, and governments do not necessarily occur in the same period in which expenses are incurred. Because of this time lag between cost and revenues, matching of costs and revenues becomes a daunting task. Moreover , certain adjustments, such as accrued payroll, prepaid items, depreciation management bonuses or income taxes are often determined at the end of a fiscal year. Accordingly, such vital adjustments are often not performed in interim reports.

In general, it is important that in assessing firm's results of operations and financial position, the analyst has to take into consideration that interim reports are far less reliable than annual data. Also, interim financial reports are subject to management manipulation.

3. Disclosure Problem

According to both GAAP and IFRS, companies listed on the stock exchange are required to include full disclosures of all useful, relevant and reliable information in their annual financial statements. IFRS 8 requires an entity to:

“disclose information to enable users of its financial statements to evaluate the nature and financial effects of the business activities in which it engages and the economic environments in which it operates” (IFRS 8, para 1).

Interim reports, on the other hand, do not require mandatory interim disclosure. In effect, the interim reporting practices are likely to vary across companies. In addition, the question of determining materiality in order to decide the nature and amount of disclosure poses yet a serious problem. not least, because Measurements for interim reporting purposes should be made on a year-to-date basis, so that the frequency of the entity's reporting does not affect the measurement of its annual results. [IAS 34.28]. indeed, IAS 34.26, requires change in estimates during interim year the nature and amount of that change must be disclosed in the notes to the annual financial statements.

External Audit

In Bahrain, as elsewhere, the Commercial Companies Act (CCA) 1975, requires that annual reports must be audited by an external auditor to add credibility, verify reliability of the financial information and assess that appropriate accounting practices are in place. Interim reports, on the other hand, are based on internal verification, normally by internal auditors. In effect, they are not audited by an independent auditor, which render the value of information less reliable and less credible internal reports.

Further, IAS 34 does not specify which entities must publish an interim financial report. That is generally a matter for local laws and government regulations. The IAS 34, requires the interim report include condensed current period financial statements and comparative information for previous period, namely statement of financial position, statement of comprehensive income, statement of cash flows, statement of changes in equity, and selected explanatory notes.

In addition, IAS 34 requires companies to apply the same accounting policies in the interim report as used in in the annual report, and that full disclosures are required when there are changes in accounting policy. Assets and liabilities are reported and measured for interim reporting purposes on the basis of information available on a year-to-date basis. Although both annual and interim financial statements are based on reasonable estimates, however, the preparation of interim financial reports often requires a greater use of estimation methods than annual financial statements, which hinders their usefulness.

METHODOLOGY

The data used in this exploratory study was based largely on information published in interim financial reports that are available at Bahrain Stock Exchange and on the websites of the listed companies.

Analyses of Results

Financial statements provide a summary of all the financial activities of an entity during specific period. These statements are used to evaluate the results of operations of a business entity (income statement), the financial position (balance sheet) and the cash position. According to the Commercial Companies Act (CCA) 1975, all companies are required to prepare annual financial statements. However, due to the ever changing business environment following globalization, the demand for more timely, detailed interim financial information gained an increasing momentum.

Interim financial reporting involves frequent financial statements throughout the year (monthly, quarterly or semiannual). These statements are often used by external users, mainly creditors and investors or internally by business executives. These reports, although unaudited and often based on estimates, are a useful tool to predict future performance to facilitate more informed business decisions. In addition, interim reports may reveal significant information concerning changes affecting the business and seasonality effects, both of which annual reports could conceal. However, there are certain inherent limitations to interim reporting as a result of their condensed time period. Also interim reports cannot account for fluctuations in revenue, temporary market conditions, or limited disclosures.

This study was carried out to determine the extent of adoption of IAS 34, by listed Bahraini companies. The study reveal that in the first year of the implementation date, more than 75 % of the listed companies had adopted IAS 34. At present, there are 50 companies listed on Bahrain Stock Exchange all adopting IAS 34, and all unanimously prepare interim reports in compliance with requirements of IAS 34.1. All the companies that prepared interim reporting in the early years in Bahrain prepared income statements, balance sheets and cash flow statements, indicating a high degree of compliance to IAS 34. Moreover, all firms published their interim reports on their websites. Companies prepared interim reports for various reasons namely, for a management control, to maintain investor confidence and satisfy listing requirements. The majority of respondents stressed that interim reports are highly relevant for their firms. Further, it has been claimed that interim reports improved performance. A good example is possibly Investcorp (a leading global provider and manager of alternative investment products). On February 5, 2019, management of Investcorp asserted that.

“Despite the challenging macroeconomic environment, the Firm’s net income for the period was \$58 million, up 5% compared to \$55 million for the six months ended December 31, 2017 (H1 FY18). On a fully diluted basis, earnings per ordinary share were \$0.74 for H1 FY19, up 6% from \$0.70 for H1 FY18. Investcorp attributes its resilient performance to the Firm’s continued focus on delivering the strategic objectives”.

Further, consistent with the requirements of IAS 34.11, all companies listed on Bahrain Stock Exchange present basic and diluted earnings per share (EPS) for the interim period. However, the respondents were not on voice regarding the cost of compliance to IAS 34, expensive or not.

Summary and Conclusion

Regardless of its serious limitations outlined earlier, interim financial reports are now sweeping across all industries worldwide. At present, companies listed on the Bahrain Stock Exchange (BSE) unanimously prepare interim financial reports in compliance with IAS 34, regardless of cost. Not least because, compliance is required by the listing requirements, listed companies are often keen to boost investor confidence, and interim financial reports are often used as a management control tool. Nevertheless, the fact that these reports are reviewed rather than audited by an independent auditor, render their level of assurance moderate and reliability limited. Further, seasonal business variation affect their predictive ability, whole the possibility of management manipulation hinders their usefulness.

This study concludes that all companies listed on the Bahrain Stock Exchange (BSE) prepare interim reports in compliance with IAS 34. Moreover, they use the same accounting policies in the interim report as used in the annual report, and provide full disclosures whenever there are changes in the accounting policy. This is consistent with earlier studies. (Joshi and Bremser, 2003;) Omar and Simon, 2011; Bayoud *et al.*, 2012; Elzahar and Hussainey, 2012; Al-Hamadeen and Badran, 2014; Spasic and Dencic-Mihajlov, 2014).

References

- Abdel-Khalik, A. R., & Espejot, J. (1978). Expectations Data and the Predictive Value of Interim Reporting. *Journal of Accounting Research*. 16 (1). 1-13.
- Al-Hamadeen, R. & Badran, S. (2014), "Nature and Determinants of CSR Disclosure: Experience of the Jordanian Public Shareholding Companies," *European Journal of Business and Management*, 6 (13), 18-34.
- Alsharairi, M. & Al-Abdullah, R. (2008). *The Impact of Adopting International Accounting Standards on the Jordanian Environment: The Perspective of Accountants, Auditors and Academicians*. International Conference on Business Globalization: Challenges and Opportunities in the 21st Century.
- Bayoud, N. S., Kavanagh, M., & Slaughter, G. (2012), "Factors Influencing Levels of Corporate Social Responsibility Disclosure by Libyan Firms: A Mixed Study." *International Journal of Economics and Finance*, 4(4),
- Brown, L. D., & Rozeff, M. S. (1979). The Predictive Value of Interim Reports for Improving Forecasts of Future Quarterly Earnings. *The Accounting Review*. 54 (3). 585-591.
- Butler, M., Kraft, A., & Weiss, I. S. (2007). The Effect of Reporting Frequency on the Timeliness of Earnings: The Cases of Voluntary and Mandatory Interim Reports. *Journal of Accounting and Economics*. 43 (2-3). 181-217.
- Chua, W. F. (1986). Radical Developments in Accounting Thought. *The Accounting Review*. 61 (4). 601-632.
- Elzahar, H., & Hussainey, K. (2012). Determinants of Narrative Risk Disclosures in UK Interim Reports. *The Journal of Risk Finance*. 13 (2). 133 -
- Hossain, M., & Hammami, H. (2009). Voluntary Disclosure in the Annual Reports of an Emerging Country: The Case of Qatar. *Advances in Accounting, Incorporating International Advances in Accounting*, 25(2), 225-
- Juhmani, O. (2012). Ownership Structure and Corporate Voluntary Disclosure: Evidence from Bahrain. *International Journal of Accounting and Financial Reporting*, 3(2), 133-148.
- Juhmani, O. (2012). Ownership Structure and Corporate Voluntary Disclosure: Evidence from Bahrain. *International Journal of Accounting and Financial Reporting*, 3(2), 133-148.
- Joshi, P.L., Al-Mudhahki, J. (2013). Empirical Study of Compliance with International Accounting Standards (IAS-1) by Stock Exchange Listed Companies in Bahrain. *Journal of Financial Management and Analysis*, 26(2),
- Joshi, P.L., Ramadhan, S. (2002). The adoption of international accounting standards by small and closely held companies: evidence from Bahrain. *The International Journal of Accounting*, 37(4), 429-440.
- Joshi, P. L., & Bremser, W. G. (2003). Interim Reporting Practices by Companies in Bahrain: Preparation of Interim Accounts and Early Adoption of IAS 34. *Advances in International Accounting*. 16. 105-122.

- KPMG. (2014). Guide to Condensed Interim Financial Statements -Disclosure checklist. KPMG.
- Krippendorff, K. (2004). *Content Analysis: An Introduction to Its Methodology*. USA: Sage Publications.
- Malek Alsharairi, Radhi Al-Hamadeen, Frances Issa, Oday Kakish “Interim Financial Reporting and Compliance with IAS 34: The Case of the Jordanian Financial Sector” *International Journal of Business and Social Science Vol. 6, No. 11; November 2015*.
- Mangena, M. (2004). *On the Perceived Importance of Disclosure Items in UK Interim Financial Reports: Evidence from the Investment Analysts*. Working paper series, Bradford University, England.
- Mangena, M., Kinman, R., & Citron, D. (2007). Investment Analysts’ Perception of Disclosure in UK Interim, Financial Reports. *Journal of Applied Accounting Research*. 8 (3). 146-185. 20.
- Nieuwoudt, M. J. (1998). Interim Financial Reporting - Compliance to Local Statutory Requirements, Local Regulatory Requirements and Local and International Accounting Standards. *Meditari Accountancy Research*. 6. 241
- Omar, B., & Simon, J. (2011). Corporate Aggregate Disclosure Practices in Jordan. *Advances in Accounting*. 27 (1). 166-186.
- Opong, K. K. (1988). *The Information Content of Interim Financial Reports – U.K. Evidence*. University of Glasgow, Scotland.
- Rahman, A. R., Tay, T. M., Ong, B. T., & Cai, S. (2007). Quarterly Reporting in a Voluntary Disclosure Environment: Its Benefits, Drawbacks and Determinants. *The International Journal of Accounting*. 42 (4). 416-442.
- Ryan, B., Scapens, R., and Theobald, M. (2002), *Research Method & Methodology in Finance & Accounting*, Thomson, London.
- Schadewitz, (2010). *Financial and Nonfinancial Information in Interim Finland Determinants and Implications*. Aalto University School of Economics, Finland.
- Securities and Exchange Board of India (SEBI), [HTTP// SEBI.gov.in](http://SEBI.gov.in)

Appendix**Companies Listed on the BSE**

Sector	Number	Apply IAS 34
Commercial banks sector	7	Yes
Investment sector	14	Yes
Insurance sector	6	Yes
Services sector	8	Yes
Industrial sector	3	Yes
Hotels & tourism sector	6	Yes
Overseas companies	5	Yes

Commercial banks sector

Stock symbol	Company
AUB	Al-Ahli United Bank
AUB.PREF.A	AUB Class A Preference Share
SALAM	Al Salam Bank
BISB	Bahrain Islamic Bank
BBK	<u>Bank of Bahrain and Kuwait</u>
NBB	National Bank of Bahrain
BSB	The Bahraini Saudi Bank

Services sector

Stock symbol	Company
BASREC	Bahrain Ship Repairing & Engineering Company
CPARK	Bahrain Car Park Company
CINEMA	Bahrain Cinema Company
DUTYF	Bahrain Duty Free Shop Complex
BMMI	Bahrain Maritime & Mercantile International
BATELCO	Bahrain Telecommunications
TRAFCO	General Trading & Food Processing Company
Nass	Nass Corporation

Insurance sector

Stock symbol	Company
BKIC	Bahrain & Kuwait Insurance Company
AHLIA	Al-Ahlia Insurance Company
AIIC	Arab International Insurance Company
TAKAFUL	Takaful International Company
ARIG	Arab Insurance Group
BNH	Bahrain National Holding Company

Investment sector

Stock symbol	Company
BARKA	Al Baraka Banking Group
INOVEST	Inovent
ABC	Arab Banking Corporation
BCFC	Bahrain Commercial Facilities
BMB	Bahrain Middle East Bank
ESTERAD	Esterad Investment Company
GFH	Gulf Finance House
GMG	Gulf Monetary Group
INVCORP	Investcorp Bank
ITHMR	Ithmaar Bank
TAIB	TAIB Bank
UGB	United Gulf Bank
UGIC	United Gulf Industries Corporation
SICO-C	Securities and Investment Company

Industrial sector

Stock symbol	Company
ALBH	Aluminium Bahrain
BFM	Bahrain Flour Mills Company
POLTRY	Delmon Poultry Company

Hotels & tourism sector

Stock symbol	Company
FAMILY	Bahrain Family Leisure Company
BHOTEL	Bahrain Hotels Company
BTC	Bahrain <u>Tourism</u> Company
SEEF	Seef Properties B.S.C.
BANADER	Banader Hotels Company
NHOTEL	National Hotels Company

Overseas companies

Stock symbol	Company
BMUSC	Bank Muscat
GLOBAL	Global Investment House
SIIG	International Investment Group
SDTL	<u>Sudan Telecommunications Company</u>
UFC	United Finance Company



Emerging Technologies in Management Accounting

Bruce H. Geddes, Ph.D.¹

¹Keiser University, US. Email: drbrucegeddes@gmail.com

Abstract

This paper gives a broad overview of emerging technology fields and their effect on management accounting. The research involved reviewing, describing, analyzing, and summarizing some of the literature in the area. The first field examined was that of business intelligence (BI) and its necessary partnership with management accounting. Following the BI section is an examination of how software aids accounting analytics. Next up is the surging field of big data and how it is poised to revolutionize the accounting profession. Included in this area are the definitions of descriptive, predictive, and prescriptive analytics. The study found that many of the emerging technologies required more research at a rapid pace because of the importance that management accountants play in the success of organizations. An additional area impacted is accounting education because of the need for business schools to turn out graduates with the necessary skills to meet the needs of a changing accounting profession.

Keywords: Emerging Technologies, Management Accounting, Accounting

Accounting is the most vital part of the information system (Andrei et al., 2018). Managerial Accounting (MA) has evolved from the traditional costing information of providing relevant information for managers to newer guidelines of Activity Based Costing and the Balanced Scorecard approach creating added value (Hint et al., 2018). Managerial accounting is the first source of information, permitting corroborating decisions to accomplish stationary goals (Andrei et al., 2018). With the onset of globalization, managerial accounting has adapted to new circumstances by changing the role and expanding utility for management (Vultur, 2018).

Expanding Role of Managerial Accounting

Accounting is a social science because it meets the criteria of it having a terminology, a study object, methodology, and laws. And because managerial accounting can provide answers to questions about costs, the contribution amounts of goods and activity, it has won the informational conflict with financial accounting. Managerial accounting includes aspects necessary to provide information to managers about processes, operations of an organization, elements needed to make decisions and possible backlash of said decisions, and those elements required to administer control in a perennial and efficient manner (Andrei et al., 2018).

Traditional accounting systems have been replaced with forward-looking and forward-thinking advanced systems focusing on efficiency and effectiveness. Managerial accounting now has the role of driving, influencing decisions, and identifying new strategies. With such innovations as Life Cycle Costing and Strategic Managerial Accounting, the focus of MA is on creating measurable value (Hint et al., 2018). Using internal information to put forth business solutions makes managerial accounting a vital management tool regardless of the degree delegation of responsibilities (Andrei et al., 2018).

Increased competition has led to the revamping of organizations' internal processes and pointing to management accounting's essential place in producing better knowledge of costs, sales prices, forecasting, and the necessary tools for a company's success. Because of the continuous changes of economies, processes, the firm's activities, the production, and distribution of products requiring constant retooling and development of management techniques have led to continued research in management accounting (Nicoletta, 2019).

The role of the accountant has changed from a number cruncher to a trusted business partner and advisor. In every company, MA is an unequalled judge of past events, the crucial guide to the present, and the fundamental advisor for the future. In the current global economy, MA is an up to date path and a realistic choice for business leaders. MA allows business leaders to handle complex problems in a complex environment. And the management accountant's role is to know the costs and aid in shaping the managers' decisions by adapting to their tools and practices to meet the demands of the decision-makers (Nicoletta, 2019).

Kose & Agdeniz (2019) noted the function of MA is to provide upper management with vital information as a part of the accounting process. And the role of MA has changed to providing information for strategic decisions, solve complex problems, and the integration of methods used in decision making. Knowledge is a source of competitive advantage, and MA is at the center of defining, collecting, measuring, and analyzing data.

Kose & Agdeniz (2019) reported the institute of Management Accountant's revision of the MA Competency Framework. The definition of the competencies is:

Strategic Management: Leading the future of strategic planning, decision making, and performance monitoring.

Reporting and Control: Standardized measuring and reporting of performance.

Technology and analytics: Manage technology and analyze data.

Business acumen and operations: Contribution of a cross-functional business partner for company-wide operations.

Leadership: Inspirational team leadership to accomplish goals.

Professional ethics and values: Demonstration of ethics, professionalism, and legal compliance to sustain a business model.

In a global business economy, to be more effective in cost identification, increased productivity leading to more substantial profits, a firm must become familiar with MA tools (Kabir, 2019)

Business Intelligence

Business intelligence (BI) are technological tools used to gather, store, access, and analyze data to aid businesses to make informed decisions. Companies use BI to become more competitive by adapting quickly to customer demands and changes in their operating environment. Although many of the attributes of BI are intangible, a business should not discard its importance (Moreno et al., 2019).

The data revolution has caused a refinement and a change in the management accountant's careers and job descriptions. Accountants will be free from robotic tasks such as billing, management reports, and organizing financial data to evaluating, analyzing, and interpreting it. The leadership of an organization will expect to be more connected with the management accountant as they will have more time to analyze trends and create insight (Lawson, 2019).

Since business intelligence and analytics (BI&A) incorporate data collection for supporting decision making and management accounting is a decision-supporting activity, there is a clear link. Therefore, the integration of the two is necessary. There are four technological aspects BI&A (1) infrastructure, which is cloud-based (2) data management (internal and external data synchronization) (3) data analysis including artificial intelligence and statistical techniques (4) information delivery. There is an integration of these aspects because you can't have one without the other, referred to as the "technology stack" of BI&A. The foundational purpose of these is to gather, process, and analyze data to improve the manager's decision making (Rikhardsson & Yigitbasioglu, 2018).

BI can aid in today's global economy of needing real-time accounting data. Real-time accounting offers a multitude of benefits over traditional methods of reporting. Higher competition requires more current information allowing managers to make needed decisions in a fast-paced business environment. Recognized among several real-time reporting technologies, BI allows the creation and disseminating of more focused and relevant data to managers empowering long-term goal planning and optimization of the daily business process by the organization (Trigo et al., 2014).

There has been an elevation of interest in BI for accounting. Highly efficient BI systems are synonymous with the implementation of performance measurement system design. However, the usefulness of BI is only practical if the organization is laser-focused with concrete procedures and is not subject to improvisation. If managers make decisions not grounded in facts and data, but from spontaneous competencies, then BI is less effective (Peters et al., 2018).

Accounting Analytics

Business analytics (BA) is using computer software to garner insight from data to make a better business decision instead of leaving things up to a standardized process. BA applies a set of technologies and methods to use data to comprehend and analyze business data. The makeup of BA is (1) predictive analytics – what could happen now or later, is there a recognizable pattern? Predictive analytics consists of large-scale data usage to highlight analytical and predictive business model performance, (2) Prescriptive analytics – the approach of optimization in two areas, addressing the best outcome, and its achievement (Nielsen, 2018). (3) Descriptive analytics – answers the question of what happened; it is the most common analytics type used by firms today and contains descriptive statistics (Appelbaum et al., 2017).

Acito & Khatri (2014) pointed out BA addresses significant issues such as financial statement effect, stock prices, the cost of capital, and the precarious balance between management behavior and shareholder interest. A synthesis of knowledge gained from BA to apply to management accounting is (1) the focus of management accountants must be on a comprehensive view in an analysis culture (2) MA must be concerned with decision-based in facts having an impact on value (3) MA must be focused on predictions and forecast (4) MA must focus on visualized reporting and presenting the information in an understandable, exciting and useful way (5) management accountants must have the skillset for MA (Nielsen, 2018).

MA can use prescriptive analytics to reinforce decisions made about uncertainties. MA must infringe on the management accountants and non-accountants to solve problems unapologetically. MA has lengthened its traditional focus to include identifying financial performance drivers and new non-financial metrics. Trends occurring in MA now are (1) no longer focusing on customer profitability and product channel (2) MA explaining role in the organization (3) the shift of predictive accounting (4) BA entrenched in enterprise performance management (5) synchronized and improved MA methods (6) recognizing information technology and sharing of services is a business (7) improved MA skills (Appelbaum et al., 2017).

Big Data

Big data is in just about every element of organizations today. For example, a business may create, purchase, extract, administer, release, retrieve, and analyze millions of data elements from within or outside of the company (Appelbaum et al., 2017). The description of Big data is (1) volume – the total amount of data stored, (2) velocity – creation intensity for new data (3) variety – the assortment of data and its byproduct (Huttunen et al., 2019). Big data will bring extraordinary benefits and gains to individuals and companies by reducing data storage costs and making enormous volumes of data available in real-time, allowing organizations to make relevant and cost-conscious decisions (La Torre et al., 2018).

Big data has structured and unstructured data. Structured data has a pattern of well-defined information, and unstructured data is streaming free information. Obtaining value from big data, structured and unstructured data must be combined so that analysis can take place. The analytics of big data is advanced. The advanced processes

allow for large volumes of data to be processed. Utilizing advanced techniques of analysis includes text, audio, video, social media. The analysis leads to descriptive, diagnostic, or predictive analytics ((Huttunen et al., 2019).

The analysis of big data is quantitative, which entails testing training and scoring models. Several techniques are applied, such as data mining, semantic analysis, data visualization, data discovery, and geospatial analysis. Additionally, analyzed are email, tweets, and transaction analysis by text mining. Big data analysis involves software for data visualization such as Hadoop, NoSQL, and Tableau. The software empowers predictive analytics since it is the most popular form of analytics used (Dewu & Barghathi, 2019).

Discussion

Business Intelligence

Business Intelligence is in its infancy. There are still businesses that do not know what to do with it or how to use it. BI systems should not be embarked on merely because other companies are doing the same. However, firms must diligently analyze what their need is in terms of these systems and what benefits may lie ahead for them (Tamandeh, S. (2016).

BI is used to administer the flow and holdings of business information inside of a company. BI helps convert massive amounts of data into pure knowledge for the organization's managers. BI's main application is the assistance in firm decision making, therefore using the system's structural and non-structural data is the basis for BI (Tamandeh, S. (2016).

BI represents a shift in data analysis done by management accountants. Management accountants no longer must use the IT department for data analysis because of the ease of predictive analysis. Predictive analysis utilizes the BI power of big data, so basing the review on historical data is not used. Focusing on its four characteristics, (1) prediction (2) rapid analysis (3) relevant business analysis, and (4) user-friendly tools, BI takes on the need for real-time analysis head-on and links it to informed decision making (Brands, 2014).

Accounting Analytics

Management accountants can use data analytics to aid organizations to interpret data. Interpretation is made by:

- Determine the best metric to track - use data analysis to develop goals on the use of data.
- Ensure "clean" data – make sure the information received is accurate and relevant.
- Utilize the functionality of available tools – analyze the system thoroughly and use all elements completely.
- Don't let new terms like 'Big Data' scare you – data does not have to be analyzed and utilized by a data center (Amato, 2016).

Management accountants will need to learn an entirely new skill set in the area of analytics to be successful. They must be able to successfully excerpt and review the immense amount of data they are privy to while familiarizing themselves with the most modern methods of data governance, query, analytics, and visualization. Linking knowledge of technology with strategic and leadership skills will allow management accounting professionals to break-down and relay the story the data is telling (Lawson, 2019).

Using analytics directed at big data, accountants can widen their monitoring techniques to include unstructured data that may lead to the identification of improvement areas. Organizations will need to develop new procedures with the ability to continuously monitor, analyze, and decipher data. Accountants, because of their unique training and skills, can utilize these skills to examine the effect this has on performance measures and how it aligns with the firm's strategic objectives. Management accountants will see their roles grow within the organization because of their ability to interject their business knowledge into the mining of structured and unstructured data (Richins et al., 2017).

Big Data

The most meaningful thing about big data is there is now a more significant variety of data, including externally generated data from websites, email, and texts. However, expansion of service is nothing new to the modern-day accountant. Accountants have a history of responsibility expansion when it comes to organizational improvement (Janvrin & Weidenmier, 2017).

The management accountant's focus has changed because of big data. Businesses invest heavily in the ability to collect, process, prepare, and analyze data, and they expect their management accountants to possess a deep, clear understanding of the data. This data needs to be of high quality. High-quality data is complete, precise, valid, accurate, relevant, and timely. Most businesses view this data as an asset that impacts the firm's bottom line tremendously. If the data is of poor quality, it will harm the management accountant because it may cause errors in the forecasting. To be good at data analysis, the management accountant needs excellent data. (Appelbaum et al., 2017).

Big data contains massive data sets that traditional database management systems cannot analyze. The majority of big data, 90%, is unstructured and contains information considered soft data such as email, social media postings, phone calls, website visits, and streamed videos. Big data can aid as long as there is a conversion of storage units of big data into actionable information. This creates a specialization where a data analyst/scientist flourish. For management accountants to use big data, these specialists must comprehend, identify, convert, and analyze the data (Warren et al., 2015).

Because management accountants have access to more data and better ways to analyze this data, systems that incorporate this additional data can use descriptive, predictive and prescriptive analytics to answer the questions of what has happened, what will happen, and what is the best solution moving forward (Appelbaum et al., 2017). Big data may speed up the merging of U.S. GAAP and IFRS, developing a global system with accounting as the lynchpin. Big data is a technological advancement that is poised to change the processing of financial transactions and usher in new forms of documentation to support management accounting (Warren et al., 2015).

Future Impact

There is no doubt managerial accounting is changing in the next few years. Managerial accounting spotlights the future and what will happen (Ioana et al., 2019). Managerial accounting has evolved from traditional costing information to new guidelines (Hint et al., 2018). With the advent of big data and data analytics, management accounting will be the center of information for decision making in an organization. Management accounting key roles are strategic management, reporting, and control, operations, and leadership (Kose & Agdeniz, 2019).

In the future, with the onset of big data and with business analytics using several different ways to analyze information, data will pervade most accounting fields, including managerial accounting. Affected will be the decisions for product mix, make or buy, pricing, and profitability. Analytic data will become an intangible asset equal to personnel, machinery, and real estate. In this globalized business world, there is an overwhelming need to keep pace with rapid change. Successful businesses will be able to change in real-time with fluidity and ease. There will be a replacement and integration of simple modeling policies into models of advance statistical data allowing managers to make changes and test even small theories (Steen, 2018).

The traditional utilization of the general ledger continues to change by automation as managers continue to ask for more from their management accountants. Today's management accountants are challenged by explosive changes to forecasts and putting the rigor of the budgetary process on edge. More questions about the story behind the numbers remain, and the expectation is management accountants will have the answers. Management accountants are at the cusp of this evolution, analyzing metadata to create a strategic analysis for management, integrating these skills to not only divulge prospective strategy but also to anticipate trends for operational data. Tomorrow's management accountants should rise above the profession's historical competencies and stereotypes to become

real business colleagues and bridge the gap of what the business desires with the customer and the enterprise data accumulated by the organization (Eng, 2018).

Accounting Education

Accounting education holds a long history of identifying the needs of the industry and adapting the curriculum to meet those needs. Because data analytics may develop into a stand-alone major, business schools should teach it (Tschakert et al., 2017). Demand is continually increasing for graduates with data analytics in their educational background (Dzuranin et al., 2018).

Unlike the predictions of some researches on the demise of accounting as a profession (Frey & Osborne, 2013), academia is familiar with the specific skill set needed to be an accountant and the unique qualifications which an accountant brings to an organization. With the identification of accountants with data analysis as an identified need, the accounting curriculum has evolved. The expectation is that universities produce properly trained accountants, and because of this expectation, schools must evolve with the profession (Dewu & Barghathi, 2019).

Future Research

There are areas in management accounting with limited research conducted. This paper touched on some, for example, business intelligence. Torres & Sidorova (2019) remarked there are many unanswered questions on how business intelligence contributes to an organization. Research has failed to consider how BI plays a role in organizational spontaneity (Peters et al., 2018). Research is needed to see if SMEs take advantage of cloud-based business intelligence solutions (Trigo et al., 2014).

There is also some research to be done in analytics, as all the additional data bought on by big data needs to be analyzed. There is a lot of unknown information concerning the role of management accountants in company strategies supported by analytics (Rikhardsson & Yigitbasioglu, 2018). From an accounting analytics viewpoint, Nielsen (2018) recommended research to produce new and enticing solutions for accounting with a data-related and comprehensive view as the beginning point. In accounting education, research needs to be conducted that includes the opinions of professional bodies of accounting (Dewu & Barghathi, 2019). Lastly, an empirical study of the managerial accounting framework to use data analytics in the surroundings of an enterprise system is necessary before its application (Appelbaum et al., 2017).

Conclusion

This paper presented a broad overview of emerging technological fields in management accounting. It began with a look at the current state of management accounting and how the role of management accountants has expanded into the vital supplier of information for business decisions. The next section explored business intelligence and its essential contribution to managerial accounting. Accounting analysis, the main feeder for business intelligence, followed the section on BI. Big data rounded out the technological aspects of the article on emerging technologies; this section described big data and how it shapes management accounting moving forward. A discussion ensued on each of the emerging technologies, and this section also included future impacts on management accounting, the evolution of accounting education, as well as a look at recommendations for future research in the field of management accounting.

References

- Acito, F., & Khatri, V. (2014). Business analytics: Why now and what next? *Business Horizons*, 57(5), 565–570.
<https://doi-org.ezp.waldenulibrary.org/10.1016/j.bushor.2014.06.001>
- Amato, N. (2016). Why the power of data is in the analysis. *Journal of Accountancy*. 54(2), pp-68-69.
<https://www.journalofaccountancy.com>

- Andrei, G., Galmeanu R., & Radu, F. (2018). Managerial accounting - an essential component of the information system. *Valahian Journal of Economic Studies*, 9(2), 109–114. <https://doi-org.ezp.waldenulibrary.org/10.2478/vjes-2018-0022>
- Appelbaum, D., Kogan, A., Vasarhelyi, M., & Yan, Z. (2017). Impact of business analytics and enterprise systems on managerial accounting. *International Journal of Accounting Information Systems*, 25, 29–44. <https://doi-org.ezp.waldenulibrary.org/10.1016/j.accinf.2017.03.003>
- Brands, K. (2014). Big data and business intelligence for management accountants. *Strategic Finance*, 95(12), pp 64–65. <https://sfmagazine.com/editorial-guidelines-submissions/>
- Contrafatto, M., & Burns, J. (2014). Social and environmental accounting, organizational change and management accounting: A processual view. *Management Accounting Research*, 24(4), 349–365. <https://doi-org.ezp.waldenulibrary.org/10.1016/j.mar.2013.10.004>
- Dewu, K., & Barghathi, Y. (2019). The accounting curriculum and the emergence of Big Data. *Accounting & Management Information Systems / Contabilitate Si Informatica de Gestiuine*, 18(3), 417–442. <https://doi-org.ezp.waldenulibrary.org/10.24818/jamis.2019.03006>
- Dzurainin, A. C., Jones, J.R., and Olvera, R.M. (2018). Infusing data analytics into the accounting curriculum: A framework and insights from faculty. *Journal of Accounting Education*, 43, 24–39. doi: 10.1016/j.jaccedu.2018.03.004.
- Eng, A. C. (2018). Tomorrow's management accountants. *Strategic Finance*, 6. <https://sfmagazine.com/>
- Frey, C. B., & Osborne, M. A. (2017). The future of employment: How susceptible are jobs to computerisation? *Technological Forecasting & Social Change*, 114, 254–280. <https://doi-org.ezp.waldenulibrary.org/10.1016/j.techfore.2016.08.019>
- Hint, M., Popa, M.-A., Trif, M., & Bădescu, M. (2018). New dimensions of managerial accounting and its influences in an unstable environment. *Annals of the University of Oradea, Economic Science Series*, 27(1), 181–191. <https://doaj.org/>
- Huttunen, J., Jauhiainen, J., Lehti, L., Nylund, A., Martikainen, M., & Lehner, O. M. (2019). Big Data, Cloud Computing and Data Science Applications in Finance and Accounting. *ACRN Oxford Journal of Finance & Risk Perspectives*, 8, 16–30. <http://www.acrn-journals.eu/>
- Ioana, M. T., Ioana, A. F., Nicoleta, D. G., & Gabriela, M.T. (2019). Know-how present status of insurances domain from the perspective of managerial accounting. *Annals of the University of Oradea, Economic Science Series*, 28(1), 194–202. <https://doaj.org/>
- Janvrin, D. J., & Weidenmier, W. M. (2017). “Big Data”: A new twist to accounting. *Journal of Accounting Education*, 38, 3–8. <https://doi-org.ezp.waldenulibrary.org/10.1016/j.jaccedu.2016.12.009>
- Kabir, M. R. (2019). Management accounting dynamics in bangladesh: Areas and factors behind the changes. *Asia-Pacific Management Accounting Journal*, 14(2), 51–77. <https://apmaj.uitm.edu.my/>
- Kose, T., & Agdeniz, Ş. (2019). The role of management accounting in risk management. *Journal of Accounting & Finance*, 509–525. <https://doi-org.ezp.waldenulibrary.org/10.25095/mufad.607200>
- La Torre, M., Botes, V.L., Dumay, J., Rea, M.A. & Odendaal, E. (2018). The fall and rise of intellectual capital accounting: new prospects from the Big Data revolution. *Meditari Accountancy Research*, 26(3), 381–399. <https://doi-org.ezp.waldenulibrary.org/10.1108/MEDAR-05-2018-0344>
- Lawson, R. (2019). New Competencies for Management Accountants. *CPA Journal*, 18–21. <https://www.cpajournal.com/>
- Moreno, V., Vieira da Silva, F. E. L., Ferreira, R., & Filardi, F. (2019). Complementarity as a Driver of Value in Business Intelligence and Analytics Adoption Processes. *Revista Ibero-Americana de Estratégia (RIAE)*, 18(1), 57–70. <https://doi-org.ezp.waldenulibrary.org/10.5585/ijsm.v18i1.2678>
- Nicoletta, G. C. (2019). Management accounting: The boundary between traditional and modern. *Journal of Academic Research in Economics*, 11(2), 453–461. <https://www.jare-sh.com/>
- Nielsen, S. (2018). Reflections on the applicability of business analytics for management accounting – and future perspectives for the accountant. *Journal of Accounting & Organizational Change*, 14(2), 167–187. <https://doi-org.ezp.waldenulibrary.org/10.1108/JAOC-11-2014-0056>
- Peters, M. D., Wieder, B., & Sutton, S. G. (2018). Organizational improvisation and the reduced usefulness of performance measurement BI functionalities. *International Journal of Accounting Information Systems*, 29, 1–15. <https://doi-org.ezp.waldenulibrary.org/10.1016/j.accinf.2018.03.005>
- Richins, G., Stapleton, A., Stratopoulos, T. C., & Wong, C. (2017). Big Data Analytics: Opportunity or Threat for the Accounting Profession? *Journal of Information Systems*, 31(3), 63–79. <https://doi-org.ezp.waldenulibrary.org/10.2308/isys-51805>
- Rikhardsson, P., & Yigitbasioglu, O. (2018). Business intelligence & analytics in management accounting research: Status and future focus. *International Journal of Accounting Information Systems*, 29, 37–58. <https://doi-org.ezp.waldenulibrary.org/10.1016/j.accinf.2018.03.001>

- Steen N. (2018). Reflections on the applicability of business analytics for management accounting – and future perspectives for the accountant. *Journal of Accounting & Organizational Change*, 14(2), 167–187. <https://doi-org.ezp.waldenulibrary.org/10.1108/JAOC-11-2014-0056>
- Tamandeh, S. (2016). The effect of business intelligence on management accounting information system. *European Online Journal of Natural and Social Sciences*, 5(1), pp. 190-199. <http://european-science.com/eojnss>
- Torres, R., & Sidorova, A. (2019). Reconceptualizing information quality as effective use in the context of business intelligence and analytics. *International Journal of Information Management*, 49, 316–329. <https://doi-org.ezp.waldenulibrary.org/10.1016/j.ijinfomgt.2019.05.028>
- Trigo, A., Belfo, F., & Estébanez, R. P. (2014). Accounting Information Systems: The Challenge of the Real-time Reporting. *Procedia Technology*, 16, 118–127. <https://doi-org.ezp.waldenulibrary.org/10.1016/j.protcy.2014.10.075>
- Tschakert, N., Kokina, J., Kozłowski, S., & Vasarhelyi, M. (2017). How Business Schools Can Integrate Data Analytics into the Accounting Curriculum. *CPA Journal*, 87(9), 10–12. Retrieved from <https://search-ebshost-com.ezp.waldenulibrary.org/login.aspx?direct=true&db=bth&AN=124942824&site=eds-live&scope=site>
- Vultur, P. (2018). Study based on the importance of the information provided by management accounting on the managerial process in the joint stock companies in the north-east area of moldova. *USV Annals of Economics & Public Administration*, 18(1), 134–142. <http://www.seap.usv.ro/annals/ojs/index.php/annals>
- Warren, J., Moffitt, K. C., & Byrnes, P. (2015). How Big Data Will Change Accounting. *Accounting Horizons*, 29(2), 397–407. <https://doi-org.ezp.waldenulibrary.org/10.2308/acch-51069>



The Role of Well-being on the Impact of High Performance Work Systems on Physicians' Job Burnout

Thadeus Mkamwa¹

¹ St. Augustine University of Tanzania, Faculty of Business Administration.
Email: thadeus.mkamwa@gmail.com

Abstract

This is a theoretical paper which examines the role of physicians' wellbeing in the relationship between utilization of High Performance Work Systems (HPWS) and Physicians' job burnout. The research is aimed at recommending a new model which should be adopted when researchers are identifying gaps that exist in theory and methodology on the link between HPWS and employee outcomes. The paper adopts among other theories a Critical Theory perspective which calls for Axel Honneth's three spheres of relationships in the communication between employees and employers. The paper starts by mapping key concepts on HPWS, physicians' well-being and physicians' burnout. The paper also identifies types of evidence that link HPWS with physicians' well-being and physicians' burnout. It ends with synthesizing existing knowledge on reducing physicians' burnout and improving physicians' well-being. Overall, the study proposes that in order to improve employee wellbeing and get away with the 'pessimistic perspective' which claims that HR practices are harmful to the employees' well-being, employers are obligated to examine operations which are based on 'personal relationships' which are either contractual or non-contractual, but still legally binding. In this way, workplaces which are using HPWS will reduce physicians' burnout and improve their wellbeing. Discussion, recommendation for future research and conclusion are made.

Keywords: High Performance Work Systems, Physicians' Wellbeing, Physicians' Job Burnout

1. Introduction

Much as researchers claim that there is neither a commonly accepted definition nor a gold standard for measuring quality of life (Katschnig, 2006:139), however, in measuring people's well-being, there is a universal agreement that quality of life is a multi-dimensional construct integrating physical, emotional, and social well-being and functioning as perceived by the individual (Lutz et al., 2007). The definition by Lutz et al. (2007) derives from the World Health Organization Quality of Life Assessment (WHOQOL), which states that quality of life (QoL) is an individual's perception of their position in life in the context of the culture and value systems in which they live and in relation to their goals, expectations, standards and concerns.

The dilemma on employees' well-being and productivity at work has been discussed and studies made without conclusive remarks (Peutere, Saloniemi, Aho, Natti, & Nummi, 2018). According to the Europe 2020 Strategy

(European Commission, 2010), the future prosperity of European workers is not based on low wages but on the high quality of working life. This makes it clear that the issue of employees' well-being and quality of life is not only an organizational or academic issue but also a political issue. Thus, improving quality of work has a potential benefit in raising worker well-being and lowering the social costs of ill-health (Felstead, Gallie, Green & Henseke, 2019).

Physicians are employees whose well-being is an issue of importance for several reasons besides the political and academic grounds mentioned above. These include:

- a. That Medicine is a unique organizational environment in which the health of physicians may be a significant risk factor for inadequate patient safety and suboptimal care. Likewise, globally, physicians are reporting increasing levels of job burnout, especially among younger physicians in training (Montgomery, 2014).
- b. Studies suggest that quality of healthcare systems is also dependent on the physicians' well-being (Wallace, Lemaire & Ghali, 2009). In surgical literature links have been established between patients' safety, medical errors, quality of life and burnout (Shanafelt, Balch, Bechamps, Russell, et al., 2010).
- c. Ethically, constant changes in the workplace context make employees' concerns secondary and neglected which erode work-related well-being which may result into negative consequences to both employees and organizations (Guest, 2017; Beer, Boselie, & Brewster, 2015).

Besides views in Strategic HRM on the negativity of HRM practices on physicians' well-being, the current concern in HRM literature is that while globally physicians are at risk of leaving their jobs and engage in different specialties; in some countries, physicians have been leaving their countries to other countries to seek for better employment environment than their own. Notwithstanding, studies are conscious of unethical trend in workplaces which encourages HRM practices which promote productivity and performance at the expense of employee well-being (Guest, 2017).

Several studies suggest that HRM practices and the so-called High-Performance Work Systems (HPWS) are associated with higher performance and higher organizational commitment, however outcomes for employees' health-related well-being are less clear-cut with some indication that HRM practices can be associated with higher stress (Guest, 2017:24; see also Van de Voorde, Paauwe, & Veldhoven, 2012; Peccei, van de Voorde & van Veldhoven, 2013). There is relatively dearth of research which links HPWS with physicians' well-being. However, for the past three decades, the literature on Strategic Human Resource Management and performance shows that researchers have focused much on organizational and performance-related outcomes and less on the health of the employees per se (Montgomery, 2016). This has led some researchers to claim that if there is any positive outcome of HRM practices to the employee well-being, then the outcome is a 'by-product' and not the intended target (Appelbaum Bailey, Berg, & Kalleberg, 2000; Guest, 2017). Studies show that individual as well as organizational work characteristics such as job monitoring, job control, effort-reward balance, organizational justice, and support at work, have predicted health-related outcomes at work (i.e., sickness, absence, and minor psychiatric morbidity (North, Syme, Feeney Head, Shipley, & Marmot, 1993; Kivimaki, Elovainio, Vahtera, & Ferrie, 2003; and Head, Kivimaki, Siegrist, et al., 2007).

Burnout is an aspect of employee health at work which is concerned with his or her physiological and psychological well-being (Danna & Griffin, 1999). Burnout among physicians is a problem which must not be ignored by any country. Estimates show that burnout levels among physicians is between 25% and 60% and can reach as high as 75% (Goehring, Bouvier, Kunzi & Bovier, 2005; Goitein, Shanafelt, Wipf, Slatore & Back, 2005). Burnout has also been associated with performance among physicians where major findings include burnout and depression being main sources of major medical errors among surgeons (Shanafelt et al., 2010). In this regard, there is great likelihood that physicians' burnout is an aspect of employees' well-being which puts their work and life at risk. If not well studied, physicians' work conditions may lead into poor policy decisions. This study is set to examine how organizations can reduce physicians' burnout and improve physicians' well-being. In this regard, the study explores the role of well-being in the relationship between the use of HPWS and physicians' job burnout.

1.1. Study Outline

This study is organized in the following manner:

- i. Introduction which covers study outline, study objectives and research questions
- ii. Theoretical concepts and arguments related to the topic
- iii. Identifying gaps that exist in theory and methodology
- iv. Mapping key concepts on HPWS, physicians' well-being and physicians' burnout
- v. Identifying types of evidence that link HPWS with physicians' well-being and physicians' burnout
- vi. Synthesizing existing knowledge on reducing physicians' burnout and improving physicians' well-being
- vii. Recommendation on a new model for future research
- viii. Conclusion

1.2. Study Objectives

This research seeks:

- i. To identify factors which show that physicians well-being is at risk
- ii. Examine the extent to which utilization of HPWS is related to the burnout problem
- iii. Suggest alternative ways to resolve the problem that exists between utilization of HRM practices (HPWS) and physicians' well-being

1.3. Research Questions

- i. To what extent is physicians' well-being at risk?
- ii. How is utilization of HPWS related to physicians' burnout and well-being?
- iii. What model is recommended to resolve the so called 'dark side of HPWS' and physician's well-being agenda?

2. Literature Review

2.1. Theoretical Constructs and Arguments

Theoretically, this study is informed by several theoretical perspectives. It is informed by Critical Theory - not much on its critique to capitalism, but on the way Max Horkheimer (from the Frankfurt Institute for Social Research, 1930s) conceived the possibility of rational organization of society where there is progress in the human domination of nature and emancipation of individuals. Unlike other traditional forms of critical theory, this theory conceives of itself as part of a struggle for an "association of liberated human beings, in which everybody would have an equal chance of self-development" (Wellmer, 2014:706).

The study likewise adopts Axel Honneth's perspective of critical theory where he proposes three relational systems, i.e., the three 'spheres of action' in modern society, namely the sphere of personal relationships, the sphere of the market economy, and the sphere of the political public (Honneth, 2014:131). The 'sphere of personal relationships' explains and enriches our understanding of the potential mechanism behind the relationship between the employer and the employee. The understanding is based on the principles of legitimation such as 'social freedom' in this particular sphere of action (Wellmer, 2014). The theory also highlights the importance of examining contractual and non-contractual roles and obligations in relational systems since they are based on legal systems (Honneth, 2014).

Another perspective which is used in this study is the Job Demand Control Theory (Karasek 1979). This theory explains the mechanism behind potential negative relationship between HR practices, the so called HPWS and employee well-being, and thus increased physicians' burnout. The 'demand-control' model of stress, for example, predicts that jobs with higher demands combined with low employee discretion or control will create the most strain (Gallie, 2005; Karasek, 1979). This theory therefore, calls for increased job control and autonomy which

must lead employees to positive health effects since “malleable features of the work environment are associated with perceived effects of work on health” (Ettner & Crzywacz, 2001:101). Work pressure and increased job demands especially long working hours have been linked to ill-being, i.e., negative indicators in employee well-being (Gallie, 2008), and increased work-life conflict (Gallie & Russell, 2009). The rationale behind these findings is a common perception that there is an increase in work intensity due to increased international competition. On the other hand, some researchers claim that despite an increase in skills development, job pressure can also be increased by additional responsibilities at work and decision making pressure (Gallie & Russell, 2009). Organizations are constantly competing to improve their productivity and performance based on the need for speed innovation. This has necessitated organizations to adopt just in time management processes, speed information transmission and decentralized decision making as organizational design methods. The blend between new technologies and new HR practices has led to the so called ‘time-based competition’ (Askenazy, Thesmar, Thoening, 2006) which puts more decision making pressure on employees.

Lastly, the study adopts Christophe Dejours’ Psychodynamics Theory of Work (Dashtipour & Vidaillet, 2017) which highlights situations in which workers should be supported by organizations to work well. With this theory, Dejours suggests that in the experience of working, based on unconscious dynamics, an encounter of the subject with the ‘real of work’ there is an affect of suffering which can or cannot be overcome or sublimated depending on circumstances. In this way, work is viewed as a field of exploitation for instrumental reasons. The theory, however, calls for collective organizational action or cooperation to transforming such affect into pleasure or good health (Dashtipour & Vidaillet, 2017). In this regard, this research is informed by Dejours concern in the process of work as described below:

Dejours’ work is concerned with identifying the conditions that turn the experience of work either into one of pleasure, subjective expansion, and freedom or one of pathological suffering. ...work is central to subjectivity and health, to the relationship between men and women, to the community, and finally to the theory of knowledge (Dashtipour & Vidaillet, 2017:19).

These theories explain potential mechanism behind the suggestion that based on the nature of their profession, physicians’ well-being is at risk in their working environment. Traditionally, the Labor Process Theorists posit that there are different and fundamentally opposite interests between employers and employees. According to Godard (2004, 2010) the need for profit overrides employees’ well-being in organizations. In this regard, should one take the Labor Process Theory perspective, HRM practices are considered as means through which employees are exploited. The practices are conceived to be managerial tools of control and monitoring resulting into employee compliance and performance (Grant, Christianson & Price, 2007).

2.2. Research Gap (Theory and Methodology)

Literature on the linkage between work and health show inconsistencies in findings across studies which could be due to methodological differences or theoretical biases (Ettner & Crzywacz, 2001) or dataset employed and specification tested (Godard, 2010). Another aspect that might be related to inconsistent findings might be geographical or national differences of the study areas (Godard, 2010). Notwithstanding, for about three decades, studies have shown that implementation of HRM practices the so called HPWS lead into positive employee behavioral outcomes such as discretionary efforts and extra role behaviors in the workplace (Huselid, 1995; Berg, Kalleberg, & Appelbaum, 2003; Elorza, Harris, Aritzeta & Balluerka, 2016). These practices have also been termed HR enhancing practices in the sense of enhancing skills, motivation and empowerment among employees (Subramony, 2009; Rauch & Hatak, 2016). HPWS have also been associated with reduced employee turnover (Huselid, 1995; Fabi, Lacoursiere & Raymond, 2015; Sikora, Ferris, & van Iddekinge, 2015). However, studies have also shown mixed results to the same research questions. Bryson & Forth (2015) for example have shown that increases in workload (worker output per hour/employees working harder) alongside static wages, has reduced fairness and threatened well-being but no evidence of improved productivity.

Notwithstanding, we are observing a movement of physicians from one country to another. These movements of physicians suggest that our understanding of the work conditions among physicians or the relationship between

them as employees and their employers is still limited. This gap of knowledge necessitates further research on the factors behind this process or the reasons behind this phenomenon. Another gap is on the way research is carried out in this HRM practices-well-being relationship. Several studies have used HR officers to ask questions about employee well-being instead of asking employees themselves. This has led to having unrealistic research procedures (e.g., common method variance) and unreliable findings since employees themselves are the best knowledgeable people of their own work conditions and their psychological or physical well-being. It is good to cite here what Kinnie, Hutchinson, Purcell, Rayton & Swart (2005:11) highlighted on this point noting that, 'the fulcrum of the HRM-performance causal chain is the employees' reactions to HR practices as experienced by them.' In this regard, our proposition is that physicians' well-being must have a role in mediating the impact of HPWS and employee work-related outcomes (these outcomes can be attitudinal or behavioral).

2.3. Mapping key concepts of HPWS

There are different approaches to understanding HRM and in particular understanding the utilization of the 'progressive' or 'high-road' HRM practices the so called HPWS (Peccei et al., 2013:16). Concepts which have been used to connote HPWS (Huselid, 1995; Appelbaum et al., 2000) include High Involvement Practices (Batt, 2000; Guthrie et al., 2001), HR enhancing practices (Sabramony, 2009), and high commitment practices (Arthur, 1994; Pfeffer, 1998). These HRM practices are characterized by the relationship between employers and employees whereby employers provide to employees the following:

- a. Opportunities for worker involvement and participation
- b. Intensive training and development, and
- c. Incentives (Wood & de Menezes, 2011)
- d. Other provisions such as providing employees with skills, knowledge and abilities, motivation and opportunities to perform their primary role task (Appelbaum et al., 2000). These approaches are meant to elicit employees' discretionary behaviors and discretionary efforts (Berg, Kalleberg, & Appelbaum, 2003; Shin & Konrad, 2017).

Besides the 'high-road' or 'progressive' HR practices, HRM is also related to 'exploitative' or 'low-road' HRM practices in employer-employee relationships (Peccei et al. 2013; Ramsay, Scholaris & Harley, 2000). These exploitative practices are a source of concern to HRM researchers and practitioners since they contribute to the 'dark side of HRM-performance' linkages. As transactional HRM systems, they include practices such as low pay, long hours, tight monitoring, low discretion, and job insecurity (Peccei et al., 2013:17).

While many studies over the past three decades have shown that High Performance Work Systems (HPWS) may benefit employers since they increase organizational performance by eliciting employee discretionary behaviors and employees in turn exhibit discretionary efforts (e.g., Berg, Kalleberg, & Appelbaum, 2003; Takeuchi, Chen & Lepak, 2009; Zatzick & Iverson, 2011; Elorza, Harris, Aritzeta, & Balluerka, 2016; Shin & Konrad, 2017), there are claims that HPWS can also (adversely) work at the cost of employee outcomes. The rationale behind this suggestion is that by their very nature HPWS could push employees to work harder to raise productivity at the cost of their well-being (e.g., Ramsay, Scholaris & Harley, 2000; Wood & De Menezes, 2011; Jensen, Patel & Messersmith, 2013, Van De Voorde & Jensen, 2016; Misra, 2018). Another view which is based on the AMO Model (Appelbaum et al., 2000) suggests that when employees are encouraged to use their Abilities when given Opportunities to do so, and when they are Motivated, their performance outcome is not an end to their benefit, rather they are used for the benefit of the organization and not for their well-being (Boxall, Guthrie & Paauwe, 2016; Guest, 2017). In this regard, under this perspective, it is claimed that HPWS has failed to service the goal of employee well-being. Overall, these scholars present what has been called the 'dark side' of High-Performance Work Practices (Van De Voorde & Jensen, 2016; Misra, 2018).

2.4. Mapping Key Concepts of Employee Well-being

Grant, Christianson & Price (2007:52) define employee well-being as 'the overall quality of an employee's experience and functioning at work.' Literature shows that there are different aspects of employee well-being. These include mental or psychological well-being, work-related well-being such as job satisfaction, and "general"

well-being, like depression and anxiety. Well-being can also be "context-free well-being" or "domain-specific" (e.g., work-related) well-being (Warr, 2007; De Witte, Pienaar & De Cuyper, 2016). Psychologists and sociologists have also developed a well-being index which includes psychological, physical and social parameters in order to capture a person's general well-being (Diener & Seligman, 2004; Grant, Christianson & Price, 2007).

Research has demonstrated that employee well-being is an important concern for organizations. Studies indicate that employee well-being has a significant impact on the performance and survival of organizations by affecting costs which are related to illness and health care (Danna & Griffin, 1999). The changing work environment suggests that there is increased work demands, work overload, and pressures at work which negatively affect employee work-related well-being (Guest, 2017; Derks & Bakker, 2010). A study by Felstead et al. (2019), for example, found that in the UK, in low skilled jobs, average levels of autonomy have declined, and work demands have increased. In similar manner, job insecurity is another aspect which affects employee work-related well-being (De Witte et al., 2016).

2.5. Link between HPWS and Well-being

Traditionally, the mainstream HRM scholars argue that there is a positive relationship between perceptions of HRM and employee well-being (Peccei, 2004). However, several studies have attempted to link HPWS and employee outcomes such as job-related well-being with different results including negative correlations and mixed results findings (Ramsay, Scholarios, & Harley, 2000; Godard, 2004; Guest, 2017). The positive side of HPWS or also called the 'high-road approach to management' (Ramsay, Scholarios, & Harley, 2000) has been and is still demonstrated by studies which link HPWS with organizational and employee outcomes across different sectors and contexts. According to some of the studies, these HR practices are associated with higher levels of well-being (Alfes, Shantz & Truss, 2012) and lower levels of stress and emotional exhaustion (Kalmi & Kauhanen, 2008). On the other hand, the critical HRM research has focused on the negative aspects of HRM practices in the sense of viewing performance management practices as coercive or inequitable management device (De Witte, 2016). This is the so called 'exploitative' or 'low-road' HRM systems (Peccei et al., 2013; Batt, 2000). These two distinct approaches to the problem always call for further research on resolving the debate on whether HRM practices in particular the HPWS are positive to employees' well-being or not.

Table 1 below provides empirical studies which have examined the link between HRM practices and employee well-being.

Author(s)	Research Study/Country	Design, Sample & Response Rate	Findings
Boxall, P. & Macky, K. (2008)	High Involvement Management Processes (HIWPs), work intensification and employee well-being	Interviews of 1004 New Zealand employees through Computer Assisted Telephone Interviews (CATI). Response rate was 34.2%. Results are based on 775 permanent employees. 58.9% were working in the private sector, followed by government department 12.6%. The interviews collected self-report perceptual data plus factual data of a personal nature	Mixed results: a) HIWPs were associated with higher job satisfaction, a better work-life balance, lower work intensification and no increased stress or fatigue. b) With increased pressure to work long hours, work overload, and job demands; HIWPs were associated with job dissatisfaction, higher stress and fatigue, and greater work-life imbalance.
Bryson, A. & Forth, J. (2015)	Study on the impact of recession on productivity on British workplaces (2004-2011) with 5 or more employees in private sector. Focus on change in organizational characteristics & individual productivity	Data used is the 2011 Workplace Employment Relations Survey 2011 (WERS). Data was collected from managers, worker representatives and employees in 2,700 workplaces with 5+ employees	Mixed results: Increases in workload (worker output per hour/employees working harder) alongside static wages. This has reduced fairness and threatened well-being but no evidence of improved productivity.

De Witte, H., Pienaar, J. & De Cuyper, N. (2016).	Examination of normal causation on the consequences of job insecurity for health and well-being	Analysis of scientific and scholarly databases for articles on employee well-being and job insecurity between 1987 and 2015. Overall, 84 articles were identified, and 57 longitudinal studies were analyzed. Most studies came from the European Union (64.9%) and 26.3% from USA and Canada, and the rest from other countries, i.e., China, Japan, and South Korea.	From 57 longitudinal studies, the study found evidence that job insecurity influences employee (somatic) health and negatively impact on (psychological) well-being over time.
Felstead, A., Gallie, D., Green, F. & Henseke, G. (2019).	Examination of the links between intrinsic job quality, work pressure, work autonomy, and worker's well-being.	Longitudinal study, with panel data from responses made in 2012 and 2014. a). Original cross-sectional study included 2782 interviews with workers aged 20–65. b) 1108 of 2497 from 2012 were re-interviewed using around half of the questions they were asked in 2012 c) Response rate to the 2012 survey was 49%, and 71% in the follow-up survey d) The results are based on 908 respondents who were employees in both surveys	Mixed results: 1. High involvement management practices decreased required effort but increased discretionary effort and reported levels of work exhaustion fell. 2. Increase in the extent of workplace computerization increased work exhaustion rate, but also increased discretionary effort.
Ungureanu, P., Bertolotti, Pilatti, M. (2019).	Comparative study on conditions for perceived Well Being Initiatives (WBIs) and received WBIs between employees and employers in 3 global companies which employ between 1,500 to 80,000 people.	Design: Qualitative Study using Grounded theory approach. Methods: use of available information (reports & strategic documents, archival data, etc.), open ended interviews with Vice President HRs, semi-structured interviews to top management, founder, HR managers and other employees from different sections. Three sites were sampled from manufacturing (200 people), tertiary (64) and 130 from quaternary services i.e., (knowledge-intensive).	There is a need for alignment of employees' attributions and employers' intentions of WBIs in implementing strategic businesses. Shared strategic intentionality shaped employees' perceptions of the WBIs packages they were offered by the employers. Effective WBIs in organizations depend on alignment of employers' intentions and employees' attributions of the initiatives made.
Villajos, E., Tordera, N., Jose M. Peiro, J.M., & Van Veldhoven, M. (2018).	Assessment of the links between employee perceptions, organizational performance and job-related employee well-being	Study 1: Participants were contacted by postgraduate students who participated in the research. Sample was 554 employees who completed the survey Majority 60.3% from service sector. Study 2: 1647 employees from 41 Spanish organizations from different sectors. HR or Firm Manager participated - Questionnaire based. 81% from the service sector	Employee support bundle (HR practices supporting employees) is a strong predictor of life satisfaction and an indicator of employee well-being General life well-being is generally and strongly related to HR employee -support practices
Wood, S., Van Veldhoven, M., Croon, & De Menezes, L. (2012).	Assessing the extent enriched job design and HIM practices influence employee well-being by testing two aspects of well-being (job satisfaction and job-related anxiety-comfort)	UK's Workplace Employment Relations Survey 2004. <i>Workplace data</i> - data from managers - face to face interview with senior person - 2295 workplaces. Response rate was 64%. <i>Employee data</i> – survey of employees, self-completion questionnaire, 22,451 employees, response rate was 61%. Findings are based on the sample of 14,127 employees and 1177 workplaces.	Mixed results: High-involvement management practices were negatively associated with well-being but had a positive association with performance.

2.6. Mapping Key Concepts of Employee Burnout

Burnout is a work-related stress disorder which affects many people in working age which results from a combination of many factors both work-related and individual-related (Salminen, Andreou, Holma, Pekkonen, & Mäkikangas, 2017). The term burnout has been used to describe different realities of people's experiences at work from fatigue, stress, loss of idealism and passion for one's work to psychological syndrome as response to chronic stressors in the job (Maslach, Schaufeli & Leiter, 2001). Three dimensions of burnout have been identified; overwhelming exhaustion, feeling of detachment from one's job and lack of accomplishment (Maslach, Schaufeli & Leiter, 2001). Some of identified factors which contribute to burnout include; time demands, lack of control,

work planning, work organization, difficult job situations and interpersonal relations (Montgomery, 2014). In assessing employee well-being, burnout has been considered as an individual problem, however, literature shows an increase in the evidence of factors that link burnout to organizational problems which are related to working environment and organizational culture (Montgomery, Todorova, Baban & Panagopoulou, 2013). Burnout, for example, is associated with patients' mortality and morbidity (Montgomery, 2014).

2.7. The Link between HPWS and Employee Burnout

McMurray, Linzer, Konrad, Douglas, Shugerman & Nelson (2000) carried a Physician Work Life Study. It was a survey which contained 150 items assessing career satisfaction and gender differences among multiple aspects of work life. The study adopted a nationally representative random stratified sample of 5,704 physicians in primary and specialty nonsurgical care (N = 2,326 respondents; 32% female, adjusted response rate = 52%). Their findings included that women had 1.6 times the odds of reporting burnout compared with men ($P < .05$), with the odds of burnout by women increasing by 12% to 15% for each additional 5 hours worked per week over 40 hours ($P < .05$). Lack of workplace control predicted burnout in women but not in men. Likewise, female physicians were more likely to report satisfaction with their specialty and with patient and colleague relationships ($P < .05$), but less likely to be satisfied with autonomy, relationships with community, pay, and resources ($P < .05$).

Likewise, a study by Dekker & Schaufeli (1995) examined the relationship between psychological distress and burnout. The findings included that job insecurity and exhaustion increased job burnout. Shanafelt et al. (2010) carried out a study on self-assessment of major medical errors, and standardized assessments of burnout and quality of life. The study was a cross-sectional survey in June 2008 with a sample of 7905 surgeons who are members of American College of Surgeons. The results showed that major medical errors reported by surgeons are strongly related to a surgeon's degree of burnout and their mental quality of life. In short, burnout was major predictor of medical errors.

Vander Elst, Van den Broeck, De Cuyper & De Witte (2014) carried a study on the links between job insecurity, job control and mental exhaustion. The study findings showed evidence of causation of loss of job control, mental exhaustion and its effect on well-being through control. Likewise, Mäkikangas & Kinnunen (2003) studied the relationship between job satisfaction and mental distress. Their findings included that job insecurity was related to ratings of emotional exhaustion and mental distress overtime. However, the study showed no effects for physical symptoms.

3. Discussion and Recommendation of a New Model

The discussion in this paper is based on the following question: how can this existing body of knowledge on the field help researchers suggest new models to reducing physicians' burnout and improving physicians' well-being? There is a connection between work conditions and health of employees. However, "multiple features of employment arrangements and workers' health is not well understood" (Ettner & Grzywacz, 2001:101) and that is why it needs to be studied. Considerable research in Strategic HRM has addressed this problem of the link between HRM practices and employee outcomes. Overall, researchers tend to agree that the conduit through which this problem can be resolved is "people." Peccei et al. (2013) for example, highlight that employee psychological, attitudinal and behavioral outcomes at work, including employee well-being, are hypothesized to play a key role in understanding the impact of HR practices on organizational and employee outcomes. In this regard, it is important to examine the mediating role of employee well-being in the impact of HR practices (i.e., HPWS) on individual or employee outcomes. By doing so, such research will be contributing to the debate on understanding the 'black box' problem which needs a critical review and empirical evidence in the SHRM literature.

There is an 'optimistic perspective' which claims that utilization of HRM practices is beneficial to the employees and that generally it improves employee attitudes, behaviors and their well-being (Peccei, 2004; Peccei et al., 2013). The basis and rationale behind this optimistic perspective is the social exchange theory (Blau, 1964; Gouldner, 1960) which asserts that employees will pay back favorably to the employers if they are treated well. In this regard, these HR practices are expected to increase employees' discretionary behaviors such as

commitment, and combined with employee empowerment and rewarding work environment, employees get quality work life (Peccei et al., 2013). Despite this optimistic perspective, however, researchers are cautious of the misuse of this perspective since it amounts to Pollyanna Fallacy which claims that people will always be looking at the positive aspects of things and thus will be grateful to those who have been good to them. This assertion is based on the norm of reciprocity theory (Gouldner 1960), which makes two minimal demands that “(1) people should help those who have helped them, and (2) people should not injure those who have helped them” (Gouldner, 1960:171).

David Guest (2017) suggests a configuration of employee and employer terms in resolving the problem of unequal gains between employers who extensively and intensively utilize HR practices (HPWS) at the expense of employees who are considered to be subjects or losers in this tension. While this study acknowledges this great suggestion, this study goes further than Guest’s suggestion in proposing the Critical Theory perspective which has been adopted in this study. Honneth’s three spheres of relationships have a bearing in what employees as individuals have to say in order to maintain their social freedom and configure their contractual and non-contractual obligations to the employer (2014:131). It is important to note what Kinnie et al. (2005:11) highlighted on this point noting that, 'the fulcrum of the HRM-performance causal chain is the employees' reactions to HR practices as experienced by them.'

In this regard, a new model which this study proposes is based on the Social Critical Theory. This study proposes that in order to get away with the ‘pessimistic perspective’ which claims that HR practices are harmful to the employees’ well-being, employers are obligated to examine operations which are based on ‘personal relationships’ which are either contractual or non-contractual, but still legally binding. In this regard, at personal level relationships, employers have to consider employees’ individual needs and properties, and at the market level they have to consider employees’ particular interests and abilities, and at political public sphere, they have to consider employee individual aims and self-determination (Honneth, 2014:131). By doing so, employees will be involved fully and will be exercising their individual and social freedom in the workplace.

4. Conclusion

The mediating role of physicians’ well-being in analysing the relationship between HPWS and physicians’ burnout is based on lack of (divergence from) policy emphasis on improving work conditions which is likely to have major leverage in reducing even other work-related problems such as work family conflict (Gallie & Russell, 2009). In this regard, in order to reduce physicians’ burnout in a HPWS workplace, policies on improving physicians’ well-being have to be aligned with employee interests. It should be remembered that research on burnout has its roots in care-giving and service occupations where the core business was the relationship between the provider and the recipient rather than a stress response to an individual (Maslach, Schaufeli & Leiter, 2001). So, establishing interpersonal relationships in the workplace might be the right thing to do in order to mitigate other symptoms of burnout such as psychological and physical ailments including mental health.’

References

- Alfes, K., Shantz, A. and Truss, C. (2012). The link between perceived HRM practices, performance and well-being: the moderating effect of trust in the employer. *Human Resource Management Journal*, 22 (4), 409–427.
- Appelbaum, E., Bailey, T., Berg, P. & Kalleberg, A. (2000). *Manufacturing Advantage: Why High-Performance Work Systems Pay Off*. Ithaca, NY: ILR Press.
- Arthur, J. B. (1994). Effects of human resource systems on manufacturing performance and turnover. *Academy of Management Journal*, 37(3), 670-687.
- Askenazy, P., Thesmar, D., & Thoenig, M. (2006). On the Relation Between Organisational Practices and New Technologies: The Role of (Time Based) Competition. *The Economic Journal*, 116(508): 128–154. <https://doi.org/10.1111/j.1468-0297.2006.01050.x>
- Beer, M., Boselie, P. and Brewster, C. (2015). ‘Back to the future: implications for the field of HRM of the multistakeholder perspective proposed 30 years ago.’ *Human Resource Management*, 54 (3), 427–438.

- Berg, P., Kalleberg, A. L., & Appelbaum, E. (2003). Balancing work and family: The role of high-commitment environments. *Industrial Relations: A Journal of Economy & Society*, 42(2), 168-188. <http://dx.doi.org/10.1111/1468-232X.00286>
- Blau, P. (1964). *Exchange and Power in Social Life*. New York: John Wiley.
- Boxall, P. & Macky, K. (2008). High-involvement work processes, work intensification and employee well-being: A study of New Zealand worker experiences. *Asia Pacific Journal of Human Resources*, 46(1): 38–55. [1038-4111] DOI: 10.1177/1038411107086542
- Boxall, P., Guthrie, J. and Paauwe, J. (2016). 'Editorial introduction: progressing our understanding of the mediating variables linking HRM, employee well-being and organisational performance.' *Human Resource Management Journal*, 26(2), 103–111
- Bryson, A. & Forth, J. (2015). 'The UK's Productivity Puzzle.' IZA Discussion Paper No. 9097. Centre for Economic Performance.
- Danna, K., & Griffin, R. W. (1999). Health and well-being in the workplace: A review and synthesis of the literature. *Journal of Management*, 25(3), 357-384.
- Dashtipour, P. & Vidaillet, B. (2017). Work as affective experience: The contribution of Christophe Dejours' 'psychodynamics of work.' *Organization*, 24(1), 18–35. DOI: 10.1177/1350508416668191
- Derks, D. & Bakker, A. (2010). The impact of e-mail communication on organizational life. *Cyberpsychology*, 4(1), 1–14.
- De Witte, H., Pienaar, J. & De Cuyper, N. (2016). Review of 30 years of longitudinal studies on the association between job insecurity and health and well-being: is there causal evidence? *Australian Psychologist*, 51(1), 18–31.
- Diener, E., & Seligman, M. E. P. (2004). Beyond money. *Psychological Science in the Public Interest*, 5(1), 1–31.
- Elorza, U., Harris, C., Aritzeta, A., & Balluerka, N. (2016). The effect of management and employee perspectives of high-performance work systems on employees' discretionary behaviour. *Personnel Review*, 45(1), 121-141. <https://doi.org/10.1108/PR-07-2014-0167>
- Ettner, S. L., & Grzywacz, J. G. (2001). Workers' perceptions of how jobs affect health: A social ecological perspective. *Journal of Occupational Health Psychology*, 6(2), 101-113. <http://dx.doi.org/10.1037/1076-8998.6.2.101>
- European Commission (2010) Europe 2020. A strategy for smart, sustainable and inclusive growth. Communication from the Commission, COM (2010) 2020 final, 3 March 2010, Brussels.
- Fabi, B., Lacoursiere, R. & Raymond, L. (2015). Impact of high-performance work systems on job satisfaction, organizational commitment, and intention to quit in Canadian organizations, *International Journal of Manpower*, 36(5):772-790. DOI: 10.1108/IJM-01-2014-0005
- Felstead, A., Gallie, D., Green, F. & Henseke, G. (2019). The determinants of skills use and work pressure: A longitudinal analysis. *Economic and Industrial Democracy*, 40(3) 730–754.
- Gallie, D. (2005). Work Pressure in Europe 1996–2001: Trends and Determinants. *British Journal of Industrial Relations*, 43(3):351-375. <doi/epdf/10.1111/j.1467-8543.2005.00360.x>
- Gallie, D. & Russell, H. (2009). Work Family Conflict and Working Conditions in Western Europe. *Social Indicators Research*, 93(3):445-467. DOI: 10.1007/s11205-008-9435-0
- Godard, J. (2004). A critical assessment of the high performance paradigm. *British Journal of industrial Relations*, 42(2), 349-378.
- Godard, J. (2010). What Is Best for Workers? The Implications of Workplace and Human Resource Management Practices Revisited. *Industrial Relations*, 49(3), 466-488. <https://doi.org/10.1111/j.1468-232X.2010.00610.x>
- Goehring, C., Bouvier, G.M., Kunzi, B., Bovier, P. (2005). Psychosocial and professional characteristics of burnout in Swiss primary care practitioners: a cross-sectional survey. *Swiss Med Wkly.*, 135(7–8):101–108.
- Goitein, L., Shanafelt, T.D., Wipf, J.E., Slatore, C.G., Back, A.L. (2005). The effects of work-hour limitations on resident well-being, patient care, and education in an internal medicine residency program. *Arch Intern Med.*, 165(22):2601–2606.
- Gouldner, A. (1960). The norm of reciprocity. *American Sociological Review*, 25(2): 161-178.
- Grant, A., Christianson, M. & Price, R. (2007). Happiness, health, or relationships? Managerial practices and employee well-being tradeoffs? *Academy of Management Perspectives*, 21(3), 51-63.
- Guest, D. (2017). Human resource management and employee well-being: towards a new analytic framework. *Human Resource Management Journal*, 27(1), 22-38. <https://doi.org/10.1111/1748-8583.12139>
- Head, J., Kivimaki, M., Siegrist, J., et al. (2007). Effort-reward imbalance and relational injustice at work predict sickness absence: The Whitehall II study. *Journal of Psychosomatic Research*, 63(4):433–440.
- Honneth, A. (2014). *Freedom's Right: The Foundations of Democratic Life*. Polity Press, Cambridge, UK.
- Jensen, J. M., Patel, P. C., & Messersmith, J. G. (2013). High-performance work systems and job control: Consequences for anxiety, role overload, and turnover intentions. *Journal of Management*, 39(6), 1699-1724. <https://doi.org/10.1177/0149206311419663>

- Kalmi, P. & Kauhanen, A. (2008). Workplace innovations and employee outcomes: evidence from Finland. *Industrial Relations: A Journal of Economy and Society*, 47(3), 430–459.
- Karasek, R. (1979). Job demands, job decision latitude, and mental strain: implications for job redesign. *Administrative Science Quarterly*, 24(2), 285–308. doi:10.2307/2392498
- Kinnie, N., Hutchinson, S., Purcell, J., Rayton, B. & Swart, J. (2005). Satisfaction with HR practices and commitment to the organisation: why one size does not fit all. *Human Resource Management Journal*, 15(4): 9-29. <https://doi.org/10.1111/j.1748-8583.2005.tb00293.x>
- Kivimäki, M., Elovainio, M., Vahtera, J., Ferrie, J.E. (2003). Organisational justice and health of employees: prospective cohort study. *Occup Environ Med.*, 60(1):27–33.
- Maslach, C., Schaufeli, W., & Leiter, M. (2001). Job burnout. *Annual Review of Psychology*, 52, 397–422. doi:10.1146/annurev.psych.52.1.397.
- Mäkikangas, A., & Kinnunen, U. (2003). Psychosocial work stressors and well-being: self-esteem and optimism as moderators in a one-year longitudinal sample. *Personality and Individual Differences*, 35, 537–557. doi:10.1016/S0191-8869(02)00217-
- McMurray, J.E, Linzer, M., Konrad, T.R., Douglas, J., Shugerman, R. & Nelson, K. (2000). The Work Lives of Women Physicians. *Gen Intern Med.* 15:372–380.
- Misra, K. (2018). High-Performance Human Resource Practices and Team Job Satisfaction: Moderating Role of Team Citizenship Behaviors. *International Journal of Human Resource Studies*, ISSN 2162-3058, Vol.8, No. 3, pp.86-102: <https://doi.org/10.5296/ijhrs.v8i3.13010>
- Montgomery, A.J. (2016). The relationship between leadership and physician well-being: a scoping review. *Journal of Healthcare Leadership*, 8:71–80.
- Montgomery, A., Todorova, I., Baban, A., & Panagopoulou, E. (2013). Improving quality and safety in the hospital: the link between organizational culture, burnout, and quality of care. *British Journal of Health Psychology*, 18(3): 656–662.
- Montgomery, A.J. (2014). The inevitability of physician burnout: implications for interventions. *Burnout Research*, 1(1):50–56.
- North F, Syme SL, Feeney A, Head J, Shipley MJ, Marmot MG. (1993). Explaining socioeconomic differences in sickness absence: the Whitehall II study. *BMJ.* 306(6874):361–366.
- Peutere, L, Saloniemä, A., Aho, S., Natti, J. & Nummi, T. (2018). High-involvement management practices, job control, and employee well-being in the public and private sectors. Evidence from Finland. *Transfer*, 24(4): 467–486: DOI: 10.1177/1024258918807387
- Peccei, R. (2004). Human Resource Management and the Search for the Happy Workplace, Rotterdam: Inaugural Lecture, Erasmus University Institute of Management.
- Peccei, R., van de Voorde, K. & van Veldhoven, M. (2013). 'HRM, well-being and performance: a theoretical and empirical review,' in J. Paauwe, D. Guest & P. Wright (eds), *HRM and Performance: Achievements and Challenges*, Chichester: Wiley, pp. 15–45.
- Ramsay, H., Scholarios, D., & Harley, B. (2000). Employees and high-performance work systems: Testing inside the black box. *British Journal of industrial relations*, 38(4), 501-531. <https://doi.org/10.1111/1467-8543.00178>
- Rauch, A. & Hatak, I. (2016). A meta-analysis of different HR-enhancing practices and performance of small and medium sized firms, *Journal of Business Venturing*, 31(5):485-504. DOI: 10.1016/j.jbusvent.2016.05.005
- Shanafelt, T.D., Balch, C.M., & Bechamps, G., et al. (2010). Burnout and medical errors among American surgeons. *Annals of Surgery*, 251(6):995-1000, DOI: 10.1097/SLA.0b013e3181bfdab3
- Salminen, S., Andreou, E., Holma, J., Pekkonen, M., Mäkikangas, A. (2017). Narratives of burnout and recovery from an agency perspective: A two-year longitudinal study. *Burnout Research*, 7, 1–9.
- Shin, D., & Konrad, A. M. (2017). Causality between high-performance work systems and organizational performance. *Journal of Management*, 43(4), 973-997. <https://doi.org/10.1177/0149206314544746>
- Subramony, M. (2009). A meta-analytic investigation of the relationship between HRM bundles and firm performance. *Human Resource Management*, 48(5), 745-768. <https://doi.org/10.1002/hrm.20315>
- Takeuchi, R., Chen, G. & Lepak, D.P. (2009) Through the looking glass of a social system: Cross-level effects of high-performance work systems on employees' attitudes. *Personnel Psychology*, 62(1): 1–29.
- Van de Voorde, K., Paauwe, J. & van Veldhoven, M. (2012). 'Employee well-being and the HRM-performance relationship: a review of quantitative studies.' *International Journal of Management Reviews*, 14: 4, 391–407.
- Van De Voorde, K., & Jensen, J. M. (2016). "High Performance at the Expense of Employee Health? Reconciling the Dark Side of High-Performance Work Systems." In *Understanding the High-Performance Workplace* (pp. 81-102). Routledge.
- Wallace, J.E., Lemaire, J.B., & Ghali, W.A. (2009). Physician wellness: a missing quality indicator. *Lancet*. 374(9702):1714–1721.

- Zatzick, C.D. & Iverson, R.D. (2011). Putting employee involvement in context: a cross-level model examining job satisfaction and absenteeism in high involvement work systems. *The International Journal of Human Resource Management*, 22(17): 3462–3476.
- Ungureanu, P., Bertolotti, F., & Pilatti, M. (2019). What drives alignment between offered and perceived well-being initiatives in organizations? A cross-case analysis of employer -employee shared strategic intentionality, *European Management Journal*, <https://doi.org/10.1016/j.emj.2019.03.005> (in press).
- Vander Elst, T., Van den Broeck, A., De Cuyper, N., & De Witte, H. (2014). On the reciprocal relationship between job insecurity and employee well-being: mediation by perceived control? *Journal of Occupational and Organizational Psychology*, 87, 671–693. doi:10.1111/joop.12068
- Warr, P. (2007). *Work, Happiness, and Unhappiness*. London: Lawrence Erlbaum Associates.
- Wellmer, A. (2014). On critical theory. *Social Research: An International Quarterly*, 81(3), 705-733.
- Wood, S., & De Menezes, L. (2011). High involvement management, high-performance work systems and wellbeing. *International Journal of Human Resource Management*, 22(7): 1585–1608.
- Wood, S., Van Veldhoven, M., Croon, & De Menezes, L. (2012). Enriched job design, high involvement management and organizational performance: the mediating roles of job satisfaction and well-being. *Human Relations*, 65(4): 419–446.



Analysis of Capital Adequacy Ratio, Prime Lending Rate, and Third-Party Funds on Profitability of Commercial Banks in Indonesia, With Liquidity as Intervening Variable

Purwani Pujiati¹, Zainul Kisman¹, Aam Bastaman¹

¹Universitas Trilogi, Indonesia

Abstract

This study aims to determine the effect of Capital Adequacy Ratio, Prime Lending Rate, and Third-Party Funds on Profitability of Commercial Bank with Liquidity as an intervening variable. The sample of this research is the banks of the BUKU IV category listed in Bank of Indonesia and its financial statements published by the Indonesia Financial Services Authority (OJK) period 2009-2018, using a cluster sampling method. There are 5 banks of the BUKU IV category as the samples. Hypothesis testing using path analysis technique. The results of this research show that Capital has a positive and significant effect on Liquidity, Third-Party Funds (bank deposits) and Prime Lending Rate has a negative and significant effect on Liquidity. Thus Third-Party Funds has a positive effect on Profitability, then Capital and Liquidity have a negative effect on Profitability, meanwhile, Prime Lending Rate does not affect Profitability. The implication of this research that the liquidity policy is a determining variable acting as an important intermediary for linking Capital Policy, interest rates, and Third-Party Funds in order to increase bank profits.

Keywords: Capital Adequacy Ratio, Prime Lending Rate, The Third Party Funds, Loan to Deposit Ratio, and Return on Assets

I. INTRODUCTION

I.1. Introduction and research rationale

Since January 5, 2011, Bank Indonesia has made an instrument for assessing the soundness of banks, namely the regulation of bank soundness using the RGEC (Risk Profile, Good Corporate Governance, Earnings, and Capital) method. Through RGEC, Bank Indonesia wants banks to be able to identify problems early, by making appropriate and faster follow-up improvements, and to apply Good Corporate Governance (GCG) and better risk management so that banks are more resilient in facing crises (Bank Indonesia, 2011).

Lembaga Pengembangan Perbankan Indonesia (LPPI) (Yudistira & Dupla, 2017), noted a number of problems that occurred in Indonesian banking. Problems in the banking sector can be seen from several factors such as efficiency, profitability, capital, and problem loans.

Bank Indonesia (BI) must close national banks if the capital adequacy ratio (CAR) of banks is less than the BI regulation at 8% because this will only cause banks liquidity problems and cause problems. Reflecting on the Century Bank case, the banking regulator has changed the Bank Indonesia Regulation (PBI) which explains that the positive CAR has been able to receive the Short-Term Funding Facility (FPJP). Whereas in the previous PBI, only banks with a minimum CAR of two percent could only submit (Purwanto, 2016).

Chairman of the Board of Commissioners of the Indonesian Deposit Insurance Corporation (LPS) Halim Alamsyah expressed in a national seminar initiated by the Institute for Development of Economics and Finance (INDEF) in Jakarta in November 2017, that the level of bank profitability has continued to decline over the past five years due to the weak margins of lending, plus the high ratio of non-performing loans. For example, for a large asset bank or commercial bank Business Activity (BUKU) IV, the acquisition of ROA in December 2015 reached 4%, then decreased to the range of 2.5% to 3% in December 2016, and stagnated at around 3% in September 2017 (Baihaqi, 2017).

The same problem also befell banks with the category of Commercial Banks Business Activities (BUKU) III with a minimum capital of IDR 5 trillion to IDR 30 trillion, relatively stable from 1.84% in November 2017 to 1.82% in the same period in 2018. As a result, a number of BUKU III banks contacted by Kontan (Kontan.co.id) only set a stagnant ROA in 2019 (Sitanggang & Tendi, 2019).

Halim Alamsyah also highlighted slowing credit growth. In September 2017, loans grew by 7.9% or decreased compared to August 2017 which amounted to 8.4%. Another cause of bank profitability continues to decline, according to Halim, which is increasingly fierce banking competition, plus the entry of players in the financial services sector, such as the financial technology industry (fintech) (Rajagukguk, 2017).

Return on Assets (ROA) is a measure of bank profitability, which ratio is used to measure the performance and effectiveness of banks in obtaining profits by utilizing the assets they have. ROA calculation using the ratio between profit before tax to total assets owned.

In the annual Economic Report released by Bank Indonesia stated that aside from the aspect of profitability and financial ratios, banking performance can also be measured from the ability of banks to raise public funds (Third Party Funds) commonly referred to as DPK. The greater the funds owned by a bank, it is also accompanied by the large opportunities for the bank to carry out its activities in achieving its objectives (Nandadipa, 2010).

Several authors have conducted similar studies with research conducted by the author on the performance of this bank, including by (Parenrengi & Hendratni, 2018), (Pardede, 2016), (Haryoso & Kusdiasmo, 2016), (Yanti & Masdjojo, 2018), and (Widiarti, Siregar, & Andati, 2015), regarding the analysis of several variables, which influence different variables in each study of bank performance.

I.2. Research Objectives

This study aims to analyze how the direct influence of CAR, SBDK and DPK variables on LDR and ROA variables, as well as the LDR effect on ROA, and the indirect effect of CAR, SBDK, and DPK on ROA through LDR as intervening variable, on banks that were collected in the BUKU IV group 2009-2018.

II. LITERATURE REVIEW AND HYPOTHESIS FORMULATION

Theory, Empirical Evidence, and Hypothesis Formulation

Return On Assets (ROA)

According to Van Horne & Wachowicz (2005), ROA measures the overall effectiveness in generating profits through available assets; the power to generate profits from invested capital. Munawir (2010) gives an understanding of ROA is one form of profitability ratios aimed at measuring the ability of companies with all funds used for company operations to generate profits. Whereas Syamsudin (2011) defines ROA as a measurement of the ability of a company to produce overall profits by means of the overall available assets. So ROA is a ratio

that shows how much net income can be obtained from all the wealth owned by banks because that is what is used is the profit rate after tax and the average bank wealth.

According to Bank Indonesia (2011), ROA can be calculated with the following formula:

$$\text{ROA} = \frac{\text{Net Profit Before Taxes}}{\text{Total Assets}}$$

Table 1. ROA Component Rating

Ratio	Rating	Predicate
ROA > 1,5%	1	Very Good
1,25% < ROA ≤ 1,5%	2	Good
0,5% < ROA ≤ 1,25%	3	Sufficient
0% < ROA ≤ 0,5%	4	Not Good
ROA ≤ 0%	5	Very Unkind

Source: SE BI No. 13/24/ DPNP 2011

Capital Adequacy Ratio (CAR)

According to Bank Indonesia (SE BI No. 13/24/ DPNP 2011) CAR is the provision of minimum capital for banks based on active risk in the broadest sense, both assets listed in the balance sheet and administrative assets as reflected in obligations that are still contingent and/or committed provided by banks for third parties as well as market risk. It can be concluded that CAR is the bank's performance ratio to measure the capital adequacy of banks to support assets that contain or generate risk, such as loans given to customers.

Bank Indonesia sets the minimum standard on CAR, which is 8%. This regulation is written in PBI No. 10/15 / PBI / 2008 article 2 paragraph 1 (BI: 2017). Based on Bank Indonesia Circular No. 3/30 / DPNP 2001 (BI: 2017). The CAR formula is as follows:

$$\text{CAR} = \frac{\text{Bank Capital}}{\text{Total of ATMR}} \times 100\%$$

Risk-Weighted Assets (ATMR) according to Sudirman (2013) is the total risk balance of bank balance sheets and administrative accounts. Balance sheet assets and administrative assets have been weighted according to a predetermined risk weighting level. Each item in an asset is assigned a risk weighting, the amount of which is based on the level of risk contained in the asset itself or the class of customers or the nature of the collateral. Supervision regarding the provisions on ATMR is to ensure that the maximum ATMR is based on the weighting set by Bank Indonesia. Risk weight ranges from 0-100% depending on the level of liquidity, the more liquid the assets, the smaller the risk weighting. The purpose of ATMR is to control the growth of bank assets that provide high returns with low risk.

Table 2. CAR component rating

Ratio	Rating	Predicate
CAR ≥ 12%	1	Very Good
9% ≤ CAR < 12%	2	Good
8% ≤ CAR < 9%	3	Sufficient
6% < CAR ≤ 8%	4	Not Good
CAR ≤ 6%	5	Very Unkind

Source: SE BI No. 13/24/ DPNP 2011

Prime Landing Rate (SBDK)

Judisseno (2002) said that interest rates are income earned by people who give excess money or surplus spending units to be used temporarily by people who need and use the money to cover their deficits or deficit spending units. Interest rates are the price of using investment funds (loanable funds). The interest rate is one indicator in determining whether someone will invest or save (Boediono, 2014).

Third-Party Funds (DPK)

According to Undang–Undang RI No. 10 1998 concerning Banking, third party funds (deposits) are funds entrusted by the public to banks based on fund storage agreements in the form of demand deposits, deposits, certificates of deposit, savings and or other similar forms. The bank obtains these funds from three sources namely, first-party funds from owners and bank profits; second party funds obtained through the money market; and third party funds sourced from public deposits in the form of demand deposits, savings, time deposits, certificates of deposit, and guarantee deposits. Of the three bank funding sources, third party funds contributed the most. Third-party funds are the most important source of funds for bank operations. These funds can be used to be placed in posts that generate income, one of which is credit.

The source of bank funds according to Kasmir (2014) is the bank's efforts to raise funds from the public. The acquisition of these funds depends on the bank itself, whether from community deposits or from other institutions. This is in accordance with the function of the bank that the bank is a financial institution in which its daily activities are engaged in finance, so the sources of bank funds are also inseparable from the financial sector itself. To support the bank's activities as a seller or provide loans, banks must first buy money or raise funds so that the difference in the interest the bank gets a profit.

Loan to Deposit Ratio (LDR)

According to Darmawi (2011), liquidity is a term used to indicate a stock of cash and other assets that are easily converted into cash. The banking health assessment tool in terms of liquidity factor that is often used is the LDR ratio.

In theory, the greater the amount of credit given, the higher the LDR and the smaller the amount of credit disbursed, the lower the LDR. This shows that the amount of credit given from a high LDR value will increase the amount of profit received by banks from interest income (Hamidah, Goldan, & Mardiyati, 2014).

The ability of banks to repay withdrawals of funds made by relying on loans provided as a source of liquidity is measured using the LDR ratio. LDR ratio comparison will be inversely proportional to bank liquidity, the higher the ratio, the lower the bank liquidity, and vice versa if the lower the LDR ratio, the higher the bank liquidity. According to Sudirman (2013), the LDR ratio can be formulated as follows:

$$\text{LDR} = \frac{\text{Credit}}{\text{Third - Party Funds}} \times 100\%$$

Table 3. LDR Component Ranking Criteria

Ratio	Ranking	Criteria
$\text{LDR} \leq 75\%$	1	Very Good
$75\% < \text{LDR} \leq 85\%$	2	Good
$85\% < \text{LDR} \leq 100\%$	3	Sufficient
$100\% < \text{LDR} < 120\%$	4	Not Good
$\text{LDR} > 120\%$	5	Very Unkind

Source: SE BI No. 13/24/ DPNP 2011.

Relationship of Capital Adequacy Ratio (CAR) to Loan to Deposit Ratio (LDR)

According to Hersugondo & Tamtomo (2012), it was found that during the research period partially, the Capital Adequacy Ratio variable had a positive and significant effect on LDR. This is intended so that the banking companies in Indonesia can make an optimal liquidity policy strategy so that the banking companies can still exist for now and in the future.

The results of data analysis proving that there is a positive and significant influence of CAR variables on LDR are also supported by the research of Ratu Edo & Wiagustini (2014), the greater the minimum capital (CAR) to overcome problems arising from bank assets that contain risks, the liquidity of a bank will get higher

The provisional hypothesis of the study is as follows:

H1: Capital Adequacy Ratio (CAR) affects the Loan to Deposit Ratio (LDR)

Relationship of Prime Lending Rate (SBDK) to Loan to Deposit Ratio (LDR)

According to Kasmir (2014), LDR is the ratio used to measure the composition of the amount of credit given compared to the number of public funds and own capital used. The higher the interest rate on credit, the less public interest in taking credit and vice versa, the lower the interest rate on loans, the higher the demand for credit from the public.

In a previous study, Fahrana (2018) found that loan interest rates had a positive but not significant effect on loans.

Provisional hypothesis formulation of these variables is as follows:

H2: Prime Lending Rate (SBDK) affects Loan to Deposit Ratio (LDR)

Relationship of Third Party Funds (DPK) to Loan to Deposit Ratio (LDR)

An increase in third party funds will result in credit growth, therefore the growth of DPK has a positive effect on LDR (Nandadipa, 2010).

Delsy Setiawati Ratu Edo's research (2014) proves that there is a positive and significant influence of the variable Third Party Fund (DPK) on Loan to Deposit Ratio (LDR). This hypothesis is also supported by Sharvina (2017) which shows that Third Party Funds (DPK) has a positive and significant effect on Loan to Deposit Ratio (LDR).

Provisional hypothesis formulation of these variables is as follows:

H3: Third Party Funds (DPK) affects Loan to Deposit Ratio (LDR)

Relationship of Loan to Deposit Ratio (LDR) to Return on Assets (ROA)

According to Nusantara (2009) the higher the LDR shows the higher the funds disbursed and the lower the LDR shows the lack of effectiveness of banks in lending.

Research conducted by Kasbal (2011), Ramdany (2012), Agustiningrum (2013) shows that LDR has a positive effect on profitability. The same results with research according to Dewi, Herawati, & Sulindawati (2015) that the Loan to Deposit Ratio (LDR) affects profitability either partially or simultaneously.

Provisional hypothesis formulation of these variables is as follows:

H4: Loan to Deposit Ratio (LDR) affects Return on Assets (ROA)

Relationship of Capital Adequacy Ratio (CAR) to Return on Assets (ROA).

The higher the CAR, the better the bank's ability to bear the risk of any risky productive credit/assets. If the CAR value is high, the bank is able to finance operational activities and make a significant contribution to profitability (Dendawijaya, 2009).

The results of research conducted by Mawardi (2005), Nusantara (2009), Bilal (2013), Wityasari (2014), Sudiyanto & Suroso (2010) show that CAR has a positive effect on profitability (ROA).

Provisional hypothesis formulation of these variables is as follows:

H5: Capital Adequacy Ratio (CAR) affects the Return on Assets (ROA).

Relationship of Prime Lending Rate (SBDK) to Return on Assets (ROA).

Based on the results of Kurniawati's research (2012), lending and interest rates together with have a significant effect on profitability (ROA). The magnitude of the effect of lending and interest rates on profitability (ROA) is 19.9% in a positive direction, while the remaining 80.1% is influenced by other factors outside this study.

Provisional hypothesis formulation of these variables is as follows:

H6: Prime Lending Rate (SBDK) affects the Return on Assets (ROA).

Relationship of Third Party Funds (DPK) to Return on Assets (ROA).

Sudiyanto (2010) examined DPK using time series data on a sample of banks listing on the IDX and concluded that Third Party Funds had a significant effect on bank profitability. While Nasution (2011), Anggreni & Suardika (2014), and Permatasari (2017) who conducted research on state-owned banks in Indonesia also produced findings that Third Party Funds had a positive and significant effect on ROA.

Provisional hypothesis formulation of these variables is as follows:

H7: Third Party Funds (DPK) affect the Return on Assets (ROA).

Relationship of Capital Adequacy Ratio (CAR) to Return on Assets (ROA) through the mediation of Loan to Deposit Ratio (LDR).

According to the Indonesian economic report, the main source of profit of a bank is obtained from the distributed credit. The amount of credit extended will determine bank profits (Kasmir, 2014). Banks that have a high CAR will also have a lot of credit, so if CAR increases it will increase the LDR (Nandadipa, 2010).

The reverse results in the study of Wityasari & Pangestuti (2014) that from the mediation test with the Sobel test found that CAR does not have an indirect effect on ROA through LDR, in other words, LDR variables cannot mediate between the independent variable (CAR) and the dependent variable (ROA). Similar to the results of research conducted by the Pangestika (2018) shows that the variable Loan to Deposit Ratio (LDR) was not found to mediate the effect of Capital Adequacy Ratio (CAR) on Return On Assets (ROA).

So that the hypothesis can be drawn as follows:

H8: Capital Adequacy Ratio (CAR) has no effect on Return on Assets (ROA) through the mediation of the Loan to Deposit ratio (LDR).

Relationship of Prime Lending Rate (SBDK) to Return on Assets (ROA) mediated by the Loan to Deposit Ratio (LDR).

In the business world will certainly affect if interest rates rise, namely in sectors that rely on financing from loans (credit). When there is an increase in credit interest, the value of the customer's business is not proportional to the financing provided and the customer objects to a high-interest rate, hence the occurrence of bad credit that will affect the bank's profit. (Syaichu & Wibowo, 2013).

So the temporary hypothesis is as follows:

H9: Prime Lending Rate (SBDK) affects the Return on Assets (ROA) mediated by the Loan to Deposit Ratio (LDR).

Third-Party Funds (DPK) affect the Return on Assets (ROA) mediated by the Loan to Deposit Ratio (LDR).

An increase in third party funds will result in credit growth, therefore the growth of DPK has a positive effect on LDR (Nandadipa, 2010). Research conducted by Harmanta & Ekananda (2005), Meydianawati (2006), Pratista (2010) produced a positive and significant DPK influence on LDR. The lower LDR shows the lack of effectiveness of banks in lending so that banks lose the opportunity to make a profit (ROA) (Rusdiana, 2012).

So from the above studies, hypotheses can be built as follows:

H10: Third Party Funds (DPK) affect the Return on Assets (ROA) mediated by the Loan to Deposit Ratio (LDR)

III. RESEARCH METHODS

III.1 RESEARCH METHODS

The object of this study is the Banking Companies listed central bank of Indonesia (BI), which has published a financial report in financial service authority (OJK) Period 2009 - 2018. Types of data used in this study are secondary data, namely in the form of panel data for all related variables. The population in this study is banking with a total of 50 companies.

Based on sample selection, the total sample of BI listed that meets the criteria is 5 companies listed on OJK in 2009-2018.

III.2. POPULATION AND SAMPLE

The population in this study is conventional commercial banks whose existence is directly monitored by the OJK, especially those included in the Commercial Banks Business Activity (BUKU) IV group with a total of 5 banks, from 2009 to 2018. Sampling using the cluster sampling method based on bank groups as the following:

1. Conventional commercial banks that are included in the BUKU IV group are published in the OJK for the period of 2009 to 2018.
2. Conventional commercial banks that have financial statement data available during the study period from 2009 to 2018.

III.3 METHOD OF ANALYSIS

In this study, the analysis method is carried out by path analysis which is a development of the regression model. Through this path analysis, the regression equation involves independent and dependent variables by testing intervening variables. Path analysis can also measure the relationship between variables in the model both directly and indirectly.

III.4. DEFINITION ON OF OPERATIONAL VARIABLES

Dependent Variables

The definition of operational variables is very important in research. This is intended to avoid misunderstandings or differences in perceptions regarding the data to be collected. In this study Return On Assets are used as dependent variables.

Return On Assets is a ratio used to measure a company's ability to generate profits.

Independent Variables

Capital Adequacy Ratio (CAR)

Capital Adequacy Ratio is the ratio of the adequacy of capital owned by banks to support assets that contain or generate risk, for example, loans granted.

Prime Lending Rate (SBDK)

Prime Lending Rate (SBDK) is a price that must be paid by debtors to banks for loans that have been given. For banks, the loan interest rate is the selling price that will be charged to debtors.

Third-Party Funds (DPK)

Third-Party Funds (DPK) are funds obtained from the community, in the sense of the community as individuals, companies, governments, households, cooperatives, foundations, etc. both in rupiah and in foreign currencies.

Intervening Variable

Loan to Deposit Ratio (LDR) is the ratio between the total volume of credit extended by banks and the number of funds received from various sources. LDR is the company's financial ratio related to liquidity.

III.5. DATA ANALYSIS

The analysis technique used in this study is path analysis. Before the path analysis is carried out, the assumption of path analysis must first test. The test consists of normality, multicollinearity, and heteroscedasticity. The path analysis model is as follows:

Substructure Equation 1:

$$Z = \rho_{zx1} x_1 + \rho_{zx2} x_2 + \rho_{zx3} x_3 + \epsilon_1$$

Substructure Equation 2:

$$Y = \rho_{yx1}.X_1 + \rho_{yx2}.X_2 + \rho_{yx3}.X_3 + \rho_{yz}.Z + \epsilon_2$$

Based on the literature review and strengthened by previous research it is suspected that variables such as CAR, SBDK, and DPK directly influence LDR and LDR also directly influences ROA. It is also assumed that CAR, SBDK, and DPK indirectly influence ROA which is mediated by the LDR variable. Thus the writer can formulate the research framework as follows:

Figure 1: Framework for Research Models

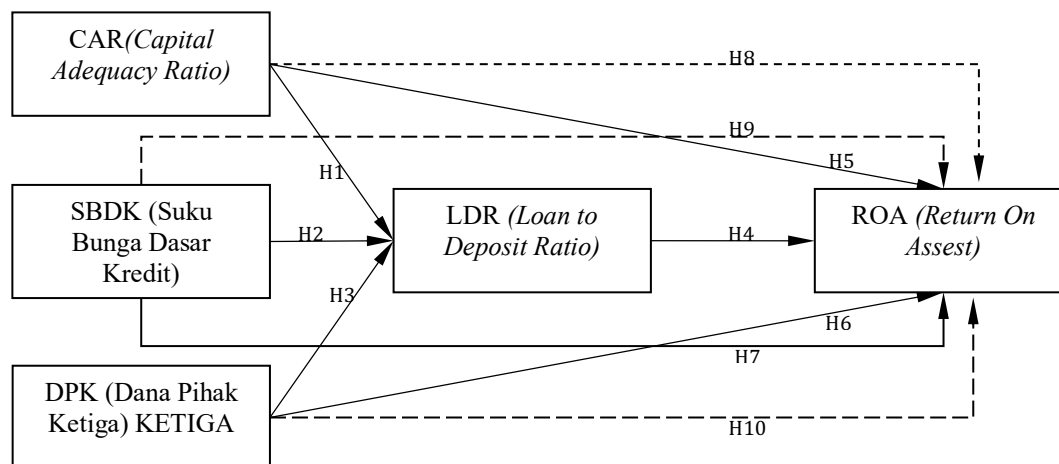

IV. RESULTS AND DISCUSSION

Before conducting statistical analysis, the data to be processed first must meet the regression analysis assumptions (Ghozali,2013).

TESTING OF THE REGRESSION ANALYSIS ASSUMPTION AND RESULT

Substructure Equation 1:

Before conducting statistical analysis, the data to be processed first must meet the regression analysis assumptions.

Table 4. One-Sample Kolmogorov-Smirnov Test

		Unstandardized Residual
N		50
Normal Parameters ^{a,b}	Mean	.0000000
	Std. Deviation	9.23691499
Most Extreme Differences	Absolute	.152
	Positive	.066
	Negative	-.152
Kolmogorov-Smirnov Z		1.075
Asymp. Sig. (2-tailed)		.198

a. Test distribution is Normal.

b. Calculated from data.

In table 4 above, the Asymp value is obtained. Sig (2- tailed) of 0.198 or can be written as a probability value (P-value) = 0.198 > 0.05 or Ho is accepted. Thus, residual data are normally distributed.

Table 5. Autocorrelation Test (Durbin- Watson) Model Summary

Model	R	R Square	Adjusted R Square	Std. Error of the Estimate	Durbin-Watson
1	,564 ^a	,318	,274	9,53336	,398

Source: data processed

From Table 5 above, the results of autocorrelation with Durbin - Watson are 0.398, which means that the autocorrelation category does not occur because the D-W number is between -2 to 2 (Singgih, 2013).

Table 6. Tolerance dan VIF (Multicollinearity Test)

Model	Collinearity Statistics	
	Tolerance	VIF
1 (Constant)		
CAR	.418	2,391
SBDK	.652	1,533
DPK	.465	2,149

Source: data processed

Based on the results of testing the tolerance value (see Table 6 above) also shows that there is no independent variable that has a tolerance value below or less than 0.10, which means that there is no correlation between the independent variables whose value is more than 95%. The results of the calculation of Variance Inflation Factor (VIF) also showed the same results, namely, there are no independent variables that have a VIF value >10. So it can be said and concluded that there is no multicollinearity between the independent variables in the regression model.

Figure 2: Scatterplot graph (Heteroscedasticity Test)

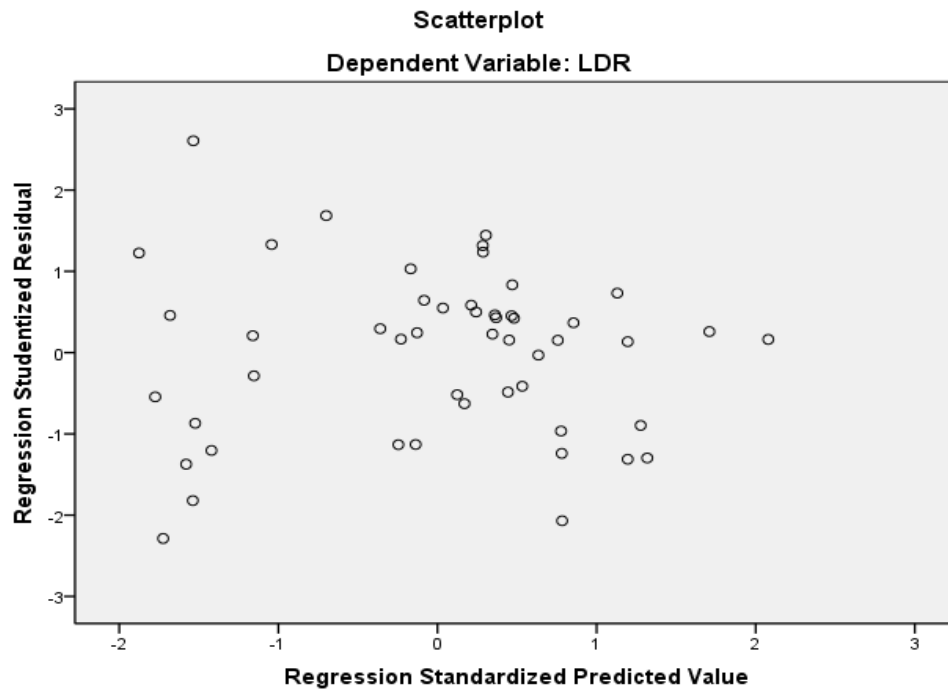

Based on Figure 2 above, there is a scatterplot graph that shows the points of diffuse and does not form certain clear patterns. So it can be concluded that there are no symptoms of heteroscedasticity.

Table 7. Summary of Results: Substructure Equation 1

Model	Standardized Coefficients	t-test Sig	Description	F-test and Sig.	R-Square
CAR → LDR	.339	.078	Significant	0,000	0,318
SBDK → LDR	-.493	.002	Significant		
DPK → LDR	-.386	.036	Significant		

Table 7 above is a summary table for substructural model equations 1. The data information contained in table 7 is derived from the processing of multiple regression analysis data. Table 7 will be used to assess whether the substructural 1 equation model is good enough (fit model) or not. Then the results in table 7 will be used to see the direct or non-direct effect on ROA in Figure 4.

Based on the table, the substructural 1 equation model is considered to be quite good (fit model) because all the independent variables (CAR, SBDK, and DPK) are significant. The R-squares are quite moderate. So overall the substructural 1 equation model and its coefficient information are valid and unbiased. Therefore we can draw conclusions using the data in table 7. Furthermore, the results can be used for the path analysis that is the basis of this research analysis (see Figure 4).

Substructure Equation 2:

Table 8. One-Sample Kolmogorov-Smirnov Test

		Unstandardized Residual
N		50
Normal Parameters ^{a,b}	Mean	.0000000
	Std. Deviation	.74739162
Most Extreme Differences	Absolute	.074
	Positive	.070
	Negative	-.074
Kolmogorov-Smirnov Z		.523
Asymp. Sig. (2-tailed)		.947

a. Test distribution is Normal.

b. Calculated from data.

In table 8 above, the Asymp value is obtained. Sig (2- tailed) of 0.947 or can be written as a probability value (P-value) = 0.947 > 0.05 or Ho is accepted. Thus, residual data are normally distributed.

Tabel 9. Autocorrelation Test (Durbin- Watson) Model Summary

Model	R	R Square	Adjusted R Square	Std. Error of the Estimate	Durbin-Watson
1	.660 ^a	.435	.385	.77990	.726

a. Predictors: (Constant), LDR, DPK, SBDK, CAR

b. Dependent Variable: ROA

From Table 9 above, it can be seen that the Durbin-Watson value is 0.726 in the autocorrelation free region because it is between -2 to +2. So the decision taken in the autocorrelation test is accepted Ho, reject H1. It means that this test does not contain an autocorrelation problem. Thus it can be concluded that the regression equation model is free from autocorrelation symptoms.

Tabel 10. Tolerance dan VIF (Multicollinearity Test)

Model	Collinearity Statistics	
	Tolerance	VIF
1 (Constant)		
CAR	.391	2,560
SBDK	.529	1,890
DPK	.422	2,367
LDR	.682	1,467

Source: data processed

Based on Table 10, the results of testing the tolerance value also shows that there is no independent variable that has a tolerance value below or less than 0.10, which means that there is no correlation between the independent variables whose value is more than 95%. The results of the calculation of Variance Inflation Factor (VIF) also showed the same results, namely, there are no independent variables that have a VIF value >10.

Figure 3: Scatterplot graph (Heteroscedasticity Test)

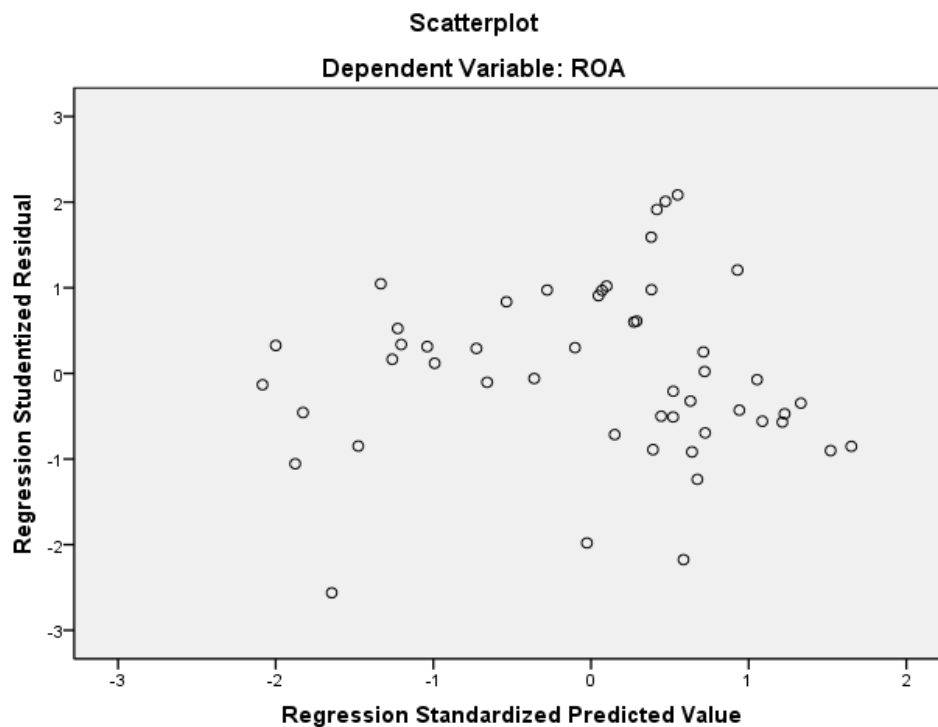

Based on Figure 3 above, there is a Scatterplot graph that shows the scattered points do not form a certain clear pattern. So it can be concluded that there are no symptoms of heteroscedasticity.

Table 11. Summary of Results: Substructure Equation 2

Model	Standardized Coefficients	t-test Sig	Description	F-test and Sig.	R-Square
CAR → ROA	-.458	.014	Significant	0,000	0,435
SBDK → ROA	-.166	.286	Not significant		
DPK → ROA	.732	.000	Significant		
LDR → ROA	-.337	.017	Significant		

Table 11 above is a summary table for substructural model equations 2. The data information contained in table 11 is derived from the processing of multiple regression analysis data. Table 11 will be used to assess whether the substructural 2 equation model is good enough (fit model) or not. Then the results in table 11 will be used to see the direct or non-direct effect on ROA in Figure 3.

Based on the table, the substructural 2 equation model is considered to be quite fit because all the independent variables (CAR, DPK, and LDR) except SBDK are significant. SBDK not significant because SBDK has no effect on ROA because banks included in BUKU IV are not under the influence of the lure of the interest rate. Facilities in the form of good service are an attraction of this bank group. The R-squares are quite moderate. So overall the substructural 2 equation model and its coefficient information are valid and unbiased. Therefore we can draw conclusions using the data in table 11. Furthermore, the results can be used for the path analysis that is the basis of this research analysis (see Figure 4).

Figure 4: Coefficient of Path Analysis

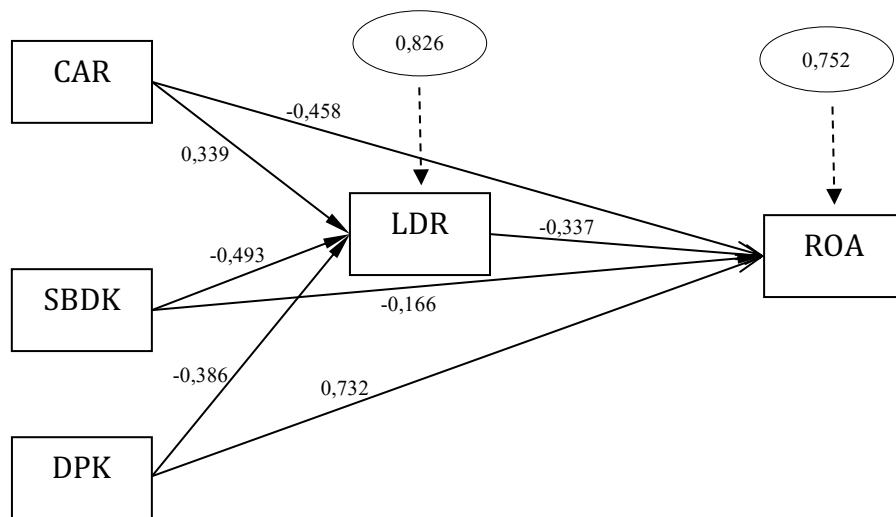

Source: data processed

The path coefficient interpretation is as follows:

- Effect of CAR on ROA :
 - Direct influence = -0,458
 - Indirect influence (through LDR) = $0,339 \times -0,337 = -0,114$
 - Total influence = $-0,458 + (-0,114) = -0,572$
- Effect of SBDK on ROA:
 - Direct influence = -0,166
 - Indirect influence (through LDR) = $-0,493 \times -0,337 = 0,166$
 - Total influence = $-0,166 + 0,166 = 0,000$
- Effect of DPK on ROA
 - Direct influence = 0,732
 - Indirect influence (through LDR) = $-0,386 \times -0,337 = 0,130$
 - Total influence = $0,732 + 0,130 = 0,862$
- The effect of LDR on ROA = -0,337

The above results are summarized in Table 12. Table 12 will be able to show the role of each variable influencing the ROA and the role of LDR as an intervening variable.

Table 12. Summary of the Value of Direct Effects, Indirect Effects and Total Effects Between Variables

Influence of Variables	Direct influence	Indirect influence (through LDR) : Intervening variable	Total influence
CAR (X1) → ROA (Y)	-0,458	$0,339 \times -0,337 = -0,114$	$-0,458 + -0,114 = -0,572$
SBDK (X2) → ROA (Y)	-0,166	$-0,493 \times -0,337 = 0,166$	$-0,166 + 0,166 = 0,000$
DPK (X3) → ROA (Y)	0,732	$-0,386 \times -0,337 = 0,130$	$0,732 + 0,130 = 0,862$
LDR (Z) → ROA (Y)	-0,337	-	-0,337
CAR (X1) → LDR (Z)	0,339	-	0,339
SBDK (X2) → LDR (Z)	-0,493	-	-0,493
DPK (X3) → LDR (Z)	-0,386	-	-0,386

Source: data processed

Based on the above calculation Table 12, it can be concluded as follows:

1. Capital Adequacy Ratio has an indirect effect on Return On Assets, from the calculation results that the direct effect of -0.458 is smaller than the indirect effect - 0.114 (through LDR). Because CAR to ROA directly has no significant effect based on table 8. So it is better to influence CAR on ROA through LDR (intervening variable) than directly. This means that CAR in influencing ROA through LDR can be seen LDR as an intervening variable and here plays a role in increasing ROA. This role is due to LDR policy improving capital management (CAR). So that the overall total CAR effect on ROA increases when managing LDR better.
2. Prime Lending Rate (SBDK=X2) has an indirect effect on Return On Assets, from the results of calculations that the direct effect of -0.166 (lowers ROA). But the indirect effect of 0.166 (through LDR). This path also shows that LDR acts as an intervening variable from SBDK to ROA. Like the CAR to ROA path. SBDK has an effect on increasing ROA through the policy of LDR. So here the role of LDR as an intervening variable between SBDK and ROA is clearly seen because it increases ROA. The role of LDR has also been shown in the upper path between the influence of CAR on ROA through LDR. LDR here shows its role in reducing smaller ROA decreases due to an increase in SBDK when there is LDR as an intervening variable.
3. Third-Party Funds (DPK) has a direct effect on Return On Assets, from the calculation results that the direct effect of 0.732, and this increase in ROA will increase if the bank applies LDR. The addition of ROA due to DPK (through LDR) is 0.130. So that overall ROA increases higher than not applying a good policy of LDR. In the conception of credit/financing management, third party funds (DPK) is the basis for decisions or policies in the Bank. If DPK in a stable condition, then this will provide a degree of certainty decision in granting credit. Because of the increase, DPK lending decisions will be even higher. DPK influential was positive towards Credit Distribution. When funds are collected from high society, then the decision to extend credit will be increasingly too high.
4. The role of LDR can improve ROA. And that role can be seen by comparing the direct influence of each variable and indirectly through intervening. By intervening in a good policy of LDR, the effect of through good policy of LDR is higher than aggressive LDR. This shows that LDR has a role in increasing ROA due to changes in CAR, SBDK, and DPK variables. This means that if a bank wants to increase profits, not only loans, bad loans and capital should be considered, but the Loan to Deposit Ratio must also be maintained.

V. CONCLUSION

Based on the results of statistical tests obtained after data collection, data processing, hypothesis testing, and analysis and discussion related to the research hypothesis, the researcher draws the conclusions as follows:

1. Partially the independent variables in this study affect the intervening variable (LDR).
2. Partially all the independent variables affect the dependent variable (ROA) except the SBDK variable which does not show influence.
3. Independent variables except DPK show an indirect effect on the dependent variable (ROA) through mediating the intervening variable (LDR).

VI. RECOMMENDATION

Based on the results of research and discussion, there are several suggestions that can be given, including:

1. For bank BUKU 4 (which is a sample), it must be prudent to manage its credit (LDR) because this variable is proven in this study as an intervening variable that mediates the influence of Capital (CAR), Third-Party Funds (bank deposits) and bank interest (Prime Lending Rate) on profit achievement (ROA) bank.
2. CIMB NIAGA as a new member in the BUKU IV bank group, as a "new child" has the smallest ratio numbers among other old BUKU IV members. Core capital is also at the threshold of entry requirements in the BUKU IV group, as well as the average annual profit being the smallest. For this reason, it is recommended that CIMB NIAGA be able to increase the ratio, profit, and core capital figures so that they do not "downgrade" from the BUKU IV bank group.
3. For the community as the owner of the funds, if they want to channel their funds to the bank in the form of investments or deposits in order to consider important variables that influence the bank where the investment

is to achieve optimal profits. And for people who need funds from banks to be wiser in making decisions to receive credit or loans from banks.

4. For future researchers, it is better to include other independent variables that contribute more to the bank's profitability variables, such as core capital variables (with regard to size), external factors (economic and political).

References

- Undang-undang Republik Indonesia No. 10 tahun 1998 tentang Perubahan atas Undang-undang no. 7 tahun 1992 tentang Perbankan. (1998). *Presiden Republik Indonesia*.
- Aji, T. W., Susyanti, J., & Slamet, A. R. (2017). Pengaruh Suku Bunga Kredit, Risiko Kredit dan Kecukupan Modal terhadap Profitabilitas. *e – Jurnal Riset Manajemen Prodi Manajemen, Fakultas Ekonomi Unisma*, website : www.fe.unisma.ac.id (email : e.jrm.feunisma@gmail.com).
- Anggreni, M. R., & Suardhika, I. S. (2014). Pengaruh Dana Pihak Ketiga, Kecukupan Modal, Risiko Kredit dan Suku Bunga Kredit pada. *ISSN: 2302-8556 E-Jurnal Akuntansi Universitas Udayana*. 9.1, 27-38 .
- Aryaningsih, N. (2008). Pengaruh suku bunga, inflasi, dan jumlah penghasilan terhadap permintaan kredit di PT. BPD Cabang Pembantu Kediri. *Lembaga Penelitian Undiksha : Jurnal penelitian dan pengembangan sains dan humaniora*.
- Baihaqi, B. (2017, Nopember 23). *Tingkat Profitabilitas Perbankan Terus Menurun*. Retrieved from *Harian Ekonomi Neraca*: <http://www.neraca.co.id/article/93427/tingkat-profitabilitas-perbankan-terus-menurun>
- Bank Indonesia, D. (2011). Penilaian Tingkat Kesehatan Bank Umum. *Surat Edaran Bank Indonesia (SE BI) No.13/ 24 /DPNP*. Jakarta, Indonesia: Bank Indonesia.
- Bank, I. (2013, Januari 15). Transparansi Informasi Suku Bunga Dasar Kredit. *Surat Edaran Bank Indonesia (SEBI) no. 14/1/DPNP*. Jakarta, Jakarta, Indonesia: Bank Indonesia.
- Boediono. (2014). *Seri Sinopsis Pengantar Ilmu Ekonomi no. 5 Ekonomi Makro*. Yogyakarta: BPFE.
- Brigham, & Houston. (2010). *Dasar-dasar Manajemen Keuangan, Buku I, Edisi II*. Jakarta: Salemba Empat.
- Budiawan. (2008). Analisis Faktor - Faktor yang Mempengaruhi Penyaluran Kredit pada Bank Perkreditan Rakyat (Studi Kasus pada BPR di Wilayah Kerja BI Banjarmasin). *Tesis Program Studi Magister Manajemen Universitas Diponegoro Semarang*.
- Christiano, M., Parengkuan, T., & Saerang, I. (2014). Analisis Terhadap Rasio-rasio Keuangan untuk mengukur Profitabilitas pada Bank-bank Swasta yang Go Public. *Jurnal EMBA Vol.2 No.4 Desember*, 817-830.
- Darmawi, H. (2011). *Manajemen Perbankan*. Jakarta: Bumi Aksara.
- Dendawijaya, L. (2009). *Manajemen Perbankan*. Jakarta: Ghalia Indonesia.
- Dewi, L. E., Herawati, N. T., & Sulindawati, E. L. (2015). Analisis Pengaruh NIM, BOPO, LDR, DAN NPL terhadap Profitabilitas (Studi Kasus Pada Bank Umum Swasta Nasional Yang Terdaftar Pada Bursa Efek Indonesia Periode 2009-2013). *e-Journal SI Ak. Universitas Pendidikan Ganesha Jurusan Akuntansi Program SI (Volume: 3 No. 1)*.
- Fahrana, H. (2018). Fkator-faktor yang Pengerahui Penyaluran Kredit pada Bank Umum Swasta Nasional Devisa di Indonesia. *Jurnal Ekonomi Daerah (JEDA) Vol 8, No 1 (2020)* .
- Ferdinand, A. (2014). *Metode Penelitian Manajemen*. Semarang: BP Universitas Diponegoro.
- Ghozali, I. (2013). *Aplikasi AnalisisMultivariate dengan Program IBM SPSS 21Update PLS Regresi*. Semarang: Badan Penerbit Universitas Diponegoro.
- Gubernur Bank Indonesia. (2012). Tentang Kegiatan Usaha dan Jaringan Kantor Berdasarkan MOdal Inti Bank. *Peraturan Bank Indonesia Nomor 14/26/PBI/2012*.
- Gudono. (2012). *Analisis Data Multivariate. Edisi 2*. Yogyakarta: BPFE.
- Hamidah, Goldan, S. M., & Mardiyati, U. (2014). Analisis Pengaruh LDR, NPL dan Operational Efficiency Ratioterhadap Return On Assets pada Bank Devisa di Indonesia periode 2010-2012. *Jurnal Riset Manajemen Sains Indonesia (JRMSI) | Vol. 5, No. 1*.
- Harjito, A., & Martono. (2010). *Manajemen Keuangan*. Yogyakarta: Ekonosia.
- Haryoso, P., & Kusdiasmo, B. (2016). Capital Adequacy Ratio (CAR) dan Dana Pihak Ketiga (DPK) terhadap Return On Asset (ROA) dengan Penyaluran Kredit sebagai Variabel Intervening. *Advance Vol.4 No.1 Edisi Maret 2016, ISSN 2337 - 5221*.
- Hasanudin, & Prihatiningsih, M. (2010). Analisis Pengaruh Dana Pihak Ketiga Tingkat Suku Bunga kredit Non Performing Loan (NPL) dan Tingkat Inflasi terhadap penyaluran Kredit Bank Perkreditan Rakyat (BPR) di Jawa Tengah. *Politektik Negeri Semarang, 5(1)*, 25-31.
- Hersugondo, & Tamtomo, H. S. (2012). Pengaruh CAR, NPL, DPK, dan ROA terhadap LDR Perbankan Indonesia. *Dharma Ekonomi. Vol.XIX, No.36, Oktober*.
- Idroes, F. (2008). *Manajemen Resiko Perbankan*. Jakarta: PT. Raja Grafindo Persada.

- Ismail. (2013). *Manajemen Perbankan. Edisi Pertama*. Jakarta: Kencana.
- Judisseno, R. K. (2002). *Sistem Moneter Dan Perbankan Di Indonesia*. Jakarta: PT Gramedia Pustaka Utama.
- Kasmir. (2014). *Bank dan Lembaga Keuangan Lainnya, Edisi Revisi*. Jakarta: Raja Grafindo Persada.
- Kieso, D. E., Jerry, J. W., & Terry, D. (2007). *Akuntansi Intermediete, Terjemahan Emil Salim, Jilid 1, Edisi Kesepuluh*. Jakarta: Erlangga.
- Kontan, H., & Adi, T. (2019, Maret 28). *Struktur dan kinerja perbankan Indonesia*. Retrieved from Kontan.co.id: <https://analisis.kontan.co.id/news/struktur-dan-kinerja-perbankan-indonesia>
- Kuncoro, M., & Suhardjono. (2011). *Manajemen Perbankan*. Yogyakarta: BPFE.
- Lokollo, N. G. (2018). Pengaruh Dana Pihak Ketiga (Dpk), Dan Non Performing Loan (Npl) Terhadap Loan To Deposit Ratio (Ldr) Dan Dampaknya Pada Profitabilitas (Studi Pada Bank Pertanian Di Asia Tenggara Dan Asia Timur). *Masters thesis, Universitas Pamulang, http://eprints.unpam.ac.id/id/eprint/7254*.
- Mishkin, F. S. (2008). *Ekonomi Uang, Perbankan, dan Pasar Keuangan, Edisi 8*. Jakarta: Salemba Empa.
- Munawir. (2007). *Analisis Laporan Keuangan*. Yogyakarta: Liberty.
- Munawir, S. (2010). *Analisa Laporan Keuangan*. Yogyakarta: Liberty.
- Nandadipa, S. (2010). Analisis Pengaruh CAR, NPL, Inflasi, Pertumbuhan DPK., *Skripsi*.
- Novianto, A. (2011). Analisis Pengaruh Nilai Tukar (Kurs) Dolar Amerika/Rupiah (Us\$/Rp), Tingkat Suku Bunga SBI, Inflasi, dan Jumlah Uang Beredar (M2) terhadap Indeks Harga Saham Gabungan (IHSG) di Bursa Efek Indonesia (BEI) periode 1999.1–2010.6. *Undergraduate thesis*.
- Nugraha, R. E. (2014). Analisis Pengaruh CAR, NPL, BOPO, ROA, dan NIM terhadap LDR (Studi Empiris Pada Perbankan Syariah Di Indonesia Periode 2010-2012). *Naskah Publikas Universitas Muhammadiyah Surakarta*.
- Otoritas Jasa Keuangan. (2017). Retrieved from www.ojk.go.id: <https://www.ojk.go.id/id/kanal/perbankan/Pages/Bank-Umum.aspx>
- Otoritas Jasa Keuangan Republik Indonesia. (2016). Tentang Kegiatan Usaha dan jaringan Kantor Berdasarkan Modal Inti Bank. *Peraturan Otoritas jasa Keuangan Nomor 6/POJK.03/2016*.
- Pardede, D. N. (2016). Analisis Pengaruh CAR, Dana Pihak Ketiga (DPK), NIM, DAN LDR terhadap Profitabilitas Perbankan dengan LDR sebagai Variabel Intervening (Studi Pada Bank Umum Go Public di Indonesia Periode 2010-2014). *Skripsi*.
- Parenrengi, S., & Hendratni, T. W. (2018). PPengaruh dana pihak ketiga, kecukupan modal dan penyaluran kredit terhadap profitabilitas bank. *Jurnal Manajemen Strategi dan Aplikasi Bisnis, Vol 1, No.1, 9 – 18*.
- Prasanjaya, A., & Ramantha, I. (2013). Analisis Pengaruh Rasio CAR, BOPO, LDR dan Ukuran Perusahaan terhadap Profitabilitas Bank yang terdaftar di BEI. *E-Jurnal Akuntansi Universitas Udayana 4.1, ISSN: 2302-8556, 230-245*.
- Prayudi, A. (2012). Pengaruh Capital Adequacy Ratio (CAR), Non-Performing Loan (NPL), BOPO, Return On Asset (ROA) dan Net Interest Margin (NIM) terhadap Loan to Deposit Ratio (LDR). *Gunadarma University E-Paper. http://papers.gunadarma.ac.id/*.
- Purwanto, D. (2016, Januari 4). *CAR Perbankan Kurang dari 8% Harus Ditutup*. Retrieved from Oke Finance: <https://economy.okezone.com/read/2010/01/04/320/290796/car-perbankan-kurang-dari-8-harus-ditutup>
- Puspitasari, D. (2009). Analisis Pengaruh CAR, NPL, NIM, BOPO, LDR, dan Suku BUnga BI terhadap ROA. *Tesis Prodi Magister Manajemen Universitas Diponegoro*.
- Putra, A. P., & Anggoro. (2017). Pengaruh Suku Bunga SBI, CAR, LDR, ROA, dan NPL terhadap Penyaluran Kredit Modal Kerja (Studi Pada Perusahaan Perbankan Yang Terdaftar Di BEI Periode 2005 – 2010) . *Other thesis, UPN "VETERAN" YOGYAKARTA http://eprints.upnyk.ac.id/id/eprint/11093*.
- Rajagukguk, R. (2017, Nopember 2017). *LPS: Profitabilitas Perbankan Turun, Rasio Kredit Bermasalah Tinggi*. Retrieved from iNews.id - Finance: <https://www.inews.id/finance/bisnis/lps-profitabilitas-perbankan-turun-rasio-kredit-bermasalah-tinggi>
- Ratu Edo, D. S., & Wiagustini, N. P. (2014). Pengaruh Dana Pihak Ketiga, Non Performing Loan, dan Capital Adequacy Ratio terhadap Loan to Deposit Ratio dan Return On Asset pada sektor Perbankan di Bursa Efek Indonesia. *ISSN : 2337-3067 E-Jurnal Ekonomi dan Bisnis Universitas Udayana 3.11, 650-673* .
- Retherford, R. D. (1993). *Statistical Models For Causal Analysis. Program on Population*. Honolulu, Hawaii: East-West Center.
- Retnadi, D. (2006). Perilaku Penyaluran Kredit Bank. *Jurnal Kajian Ekonomi*.
- Romadhoni, E. N. (2014). Analisis Pengaruh Capital Adequacy Ratio (CAR), Non Performing Loan (NPL), Biaya Operasional Pendapatan Operasional (BOPO), Return On Asset (ROA) dan Net Interest Margin (NIM) terhadap Loan to Deposit ratio (LDR). *Universitas Muhammadiyah Surakarta*.
- Sarwono, J. (2006). *Metode Penelitian Kuantitatif dan Kualitatif*. Yogyakarta: Graha Ilmu.
- Sharvina, A. (2017). Pengaruh Dana Pihak Ketiga (Dpk) Dan Capital Adequacy Ratio (Car) Terhadap Loan To Deposit Ratio (Ldr) Pada Pt. Bank Negara Indonesia (Persero)Tbk. <http://repository.ekuitas.ac.id/handle/123456789/456>.
- Siamat, D. (2005). *Manajemen Lembaga Keuangan. "Kebijakan Moneter dan Perbankan" edisi kesatu*. Jakarta: Fakultas Ekonomi Universitas Indonesia.

- Sinungan, M. (2000). *Manajemen Dana Bank*. Jakarta: Bumi Aksara.
- Sipahutar, M. A. (2007). *Persoalan-persoalan Perbankan Indonesia*. Jakarta Pusat: Gorga Media.
- Sitanggang, L. M., & Tendi. (2019, Pebruari 5). *Return on asset (ROA) dari bank BUKU III menyusut di tahun 2018 lalu*. Retrieved from Kontan.co.id: <https://keuangan.kontan.co.id/news/return-on-asset-roa-dari-bank-buku-iii-menyusut-di-tahun-2018-lalu>
- Sitorus, R. (2017, Desember 12). *Profitabilitas Perbankan Diproyeksikan Kian Tergerus*. Retrieved from Bisnis.com: <https://finansial.bisnis.com/read/20171212/90/717780/profitabilitas-perbankan-diproyeksikan-kian-tergerus>
- Sudirman, W. (2013). *Manajemen Perbankan – Menuju Bankir Konvensional yang Profesional*. Jakarta: Kencana Prenada Media Grup.
- Sugiyono. (2007). *Statistik Untuk Penelitian*. Bandung: CV. Alfabeta.
- Sunariyah. (2013). *Pengantar Pengetahuan Pasar Modal, Edisi 6*. Yogyakarta: UPP STIM YKPN.
- Syaichu, M., & Wibowo, S. E. (2013). Analisis Pengaruh Suku Bunga, Inflasi, CAR, BOPO, NPF. *Diponegoro Journal of Management Volume 2, Nomor 2, ISSN (Online): 2337-3792*, 01-10.
- Syamsudin, L. (2011). *Manajemen Keuangan Perusahaan*. Jakarta: Rajawali Pers.
- Van horne, J. C., & wachowicz, J. J. (2005). *Fundamental of Financial Management/Prinsip-prinsip Manajemen Keuangan (Edisi Kedua belas)*. Jakarta: Salemba Empat.
- Widiarti, A. W., Siregar, H., & Andati, T. (2015). The Determinants of Bank's Efficiency in Indonesia. *Bulletin of Monetary, Economics and Banking, Volume 18, Number 2*.
- Wityasari, M., & Pangestuti, I. R. (2014). Analisis Pengaruh CAR, DANA PIHAK KETIGA (DPK), NPL, dan LDR terhadap Profitabilitas Perbankan dengan LDR sebagai Variabel Intervening. *Diponegoro Journal of Manajemen*, 01-14.
- Yanti, S. T., & Masdjojo, G. N. (2018). Pengaruh Capital Adequacy Ratio, Loan to Deposit Ratio, Net Interest Margin, dan Non Performing Loan terhadap Profitabilitas pada Bank Umum Swasta Nasional Devisa periode 2013-2017 . *Dinamika Akuntansi, Keuangan dan Perbankan, Vol. 7, No. 2*, 173 - 185 .
- Yudistira, G., & Dupla, K. (2017). *LPPI ungkap persoalan di perbankan Indonesia*. Retrieved from Kontan.co.id: <https://keuangan.kontan.co.id/news/lppi-ungkap-persoalan-di-perbankan-indonesia>
- Yudistira, G., & Kartika, H. (2018, Agustus 27). *Ini penyebab rasio profitabilitas bank swasta lebih rendah dari bank BUMN*. Retrieved from Kontan.co.id: <https://keuangan.kontan.co.id/news/ini-penyebab-rasio-profitabilitas-bank-swasta-lebih-rendah-dari-bank-bumn>
- Yuliani. (2017). Hubungan Efisiensi Operasional dengan Kinerja Profitabilitas pada Sektor Perbankan yang Go Publik di Bursa Efek Jakarta. *Jurnal Manajemen & Bisnis Sriwijaya Vol. 5 No. 10*.
- Zain, D. (2018). Riset Bisnis. <https://slideplayer.info/slide/12270081/>, (pp. 01-101).



Crime Treasure Islands: Tax Havens, Tax Evasion and Money Laundering

Michele Sabatino¹

¹ Assistant Professor, Department of Economics and Law Kore University of Enna, V.le delle Olimpiadi, Cittadella Universitaria, 94100 Enna, e-mail: michele.sabatino@unikore.it

Abstract

Globalization has encouraged the introduction of economic crime at the international level. Organized crime easily entered in legitimate activities through money laundering operations. In this context "tax havens" play an essential role in the globalization of financial crime. In these places, in fact, crime launders money coming from illegal activities and reinvests it in new activities. This paper intends to examine in depth the "chain" of illegal money with reference to "tax havens," starting from their definition, and detecting the existing network between tax evasion, money laundering and reinvestment in lawful activities.

Keywords: Tax Haven, Tax Evasion, Laundering, Off-shore company

JEL: F38, H26, K14

1. Introduction

The increasing expansion of criminal phenomena within legal economic activities has enforced the awareness that an efficient policy against organized crime cannot be exclusively a matter of criminal law measures implementation, but new strategies have to be carried out, starting from the relationship between tax crimes and criminal organizations in its multiple angles.

In this regard, indeed, it should be pointed out that the relationship between the achievement of the wealth through criminal activities and the taxation of the earnings that come about from these activities, mainly, has been examined through a tax policy focused on the research of tax revenue and the repression of the phenomenon of evasion. The struggle against tax evasion is conceived as a way to "make revenue" and to reduce tax pressure on legal activities and citizens.

In a fast-changing world and in the perspective of finding new law enforcement strategies against the presence of criminal organizations in legal markets, it is useful to analyze, on one hand, the connection between money laundering and tax evasion, and, on the other, it is necessary to make efforts and use resources, at different levels, national and international, in order to battle the so called "tax havens."

The world economic scenario, although constantly evolving, is, in fact, characterized by already integrated and highly competitive financial systems, with the presence of a widespread diffusion of banking and para-banking services aiming to offer on market appropriate operational instruments for several needs. This is the result both of the globalization of the economy and the extensive process of monetary liberalization with the consequent large fluctuation of assets at both national and transnational level, as well as with the advent of the internet. Moreover, in the intermediary sector, the international competition has solicited wide-ranging financial initiatives, at times ambitious and sophisticated, simultaneously concurrent cause and consequence of the interdependence of markets of different economies.

In this context, the organized crime easily entered in the legal market taking on the typical models of a company: the connection between the illegal and legal activities is exactly represented by money laundering, often put into practice through financial operations which generate evasion phenomena and tax elusion, both national and international. It is not by chance that the connection between money laundering and tax evasion has repeatedly been the focus of particular attention by the European Union, the OECD and the G20 countries, even if the action against money laundering and tax havens has not always been connected to the repression of crime organization, but rather to prevent the financing of terrorist organizations.

Several researches and investigations have, in fact, allowed to observe that "tax havens," carry out an essential function in the globalization of the activities related to financial crime because they ensure to their client's tax reliefs, banking secrecy and judicial immunity. Those criminal activities generate important profits, that subsequently can destabilize economic, industrial and financial sectors, in other words impeding both national and international policies. Criminal organizations take advantage and abuse of the discrepancies of the legislative, regulatory, legal and judicial systems. In this way they can prosper without being regulated by common laws to which legal activities must comply.

This paper, therefore, aims to analyze matters such as money laundering, tax evasion and elusion which through "tax havens" find the best way to avoid inspections and taxation of national States. These "sacred places," often represent the opportunity for crime to launder money that comes from illicit activities and reinvest it on legal ones. A proper "bleaching operation" of the assets with the advantage to be extremely confidential and devoid of any taxation. Therefore, while it is true, that tax havens are where it occurs one of the most form of inequality between wealth, citizens, taxed companies and wealth without any tax impositions, eluding the role of the national State as an equalization instrument, also, these places are where criminal organizations are strengthened (and nowadays we can even talk about terroristic organizations) becoming transnational and able to reinvest the huge and illicit assets in legal companies.

2. Definition and business

According to the most common definition "tax havens" are those Countries or territories with lower taxation or where, as it often happens in many cases, it is not applied any taxation¹. The aim of these tax havens is to attract non residents companies or natural persons, in order to let them start commercial activities or move their assets, avoiding or bypassing the regulations of their Countries where they actually carry out their activities. The expression "haven or off-shore financial center" is related to islands such as Cayman or Bahamas, and the states of the hinterland such as Switzerland (Tab 1). Actually we are referring to offshore activities when a subject resident in a country – more or less falsely - holds assets or domiciles the business in another Country in order to benefit of tax breaks. One of the peculiarity of many tax havens is the secrecy or opacity that guarantees the anonymity of the subjects that own financial activities and commercial companies.

¹ There are several definitions of "tax haven." According to the OECD, in the strict sense, they are those countries with no or only nominal income tax, which do not exchange information on tax matters with other countries, which are characterized by substantial financial opacity and do not require, for the purposes of residence, the requirement for the exercise of the effective activity on the national territory. Many countries with no or only nominal taxation, but which declare tax cooperation with other states, are therefore not included in the tax havens list in the strict sense. Below a broader concept of tax haven will be used, as in the aforementioned text of Zucman. For defining and methodological aspects, see: M. CARBONE, M. BOSCO, L. PETESE, The geography of tax havens, IPSOA Manuals, Wolters Kluwer, Milan, 2015. See also: M. GARA, P. DE FRANCESCIS, Tax havens: operational characteristics, empirical evidence and financial anomalies, Bank of Italy, Financial Information Unit for Italy, anti-Money Laundering notebooks, n. 3, 2015.

The way these territories or states work is relatively simple, although each of them is regulated by a specific legislation. Many banks receive money coming from all over the world – without any preclusion related to the identity of the owners often requesting moderate bank charges compared to those applied by others credit institutions. In this way they can let money "work" legally on international financial markets, and clients cannot have the obligation to justify the origin of their capitals. The protection of the anonymity is guaranteed. Therefore these places are far from being little faraway lands, rather the off-shore areas are represented by a geography that closely corresponds to the main centers of the economic activity: United States, Europe, Asia.

Table n. 1 – The main tax havens

Tax havens	Under the administration of:	Offered services
City of London	Great Britain	<ul style="list-style-type: none"> • On the tax front, rates of 5% and 1% and numerous legal loopholes • Administrative facilities in corporate management • Taxes on natural persons are very favorable and often insignificant, with the acquisition of the status of “resident not domiciled” it is possible to benefit of the taxation of incomes produced only in the United Kingdom.
Jersey, Guernsey, Isle of Mann, Cayman Islands, British Virgin Islands, Turk Islands, Caicos, Bermuda, Bahamas, Anguilla, Antigua and Barbuda, Belize	Great Britain	They refer to the tax system of Great Britain
Delaware	United States of America	<ul style="list-style-type: none"> • Among the best off-shore state in the world for secrecy and low taxation • Under the tax profile, very low taxation on companies incomes and profits
Switzerland	Switzerland	<ul style="list-style-type: none"> • Absence of obstacles to international capital transfers • Fiscally it is a state with a strong competitive regime • Banking secret is protected by the art. 28 c.c swiss, art. 27 federal banking law and art. 23-ter federal banking law
The Principality of Liechtenstein	Switzerland	Banking secrecy is guaranteed by strict rules
The Grand Duchy of Luxembourg	Luxembourg	<ul style="list-style-type: none"> • Extremely favorable tax laws with a net cut of 80% of taxable income • absence of withholding tax • banking secrecy
Netherlands and Netherlands Antilles	Netherlands	<ul style="list-style-type: none"> • Tax exemption on income flows to other jurisdictions in exchange for very low charges
The Principality of Monaco	The Principality of Monaco	<ul style="list-style-type: none"> • Tax system based on indirect withdrawals • no taxation for those who acquire the status of a Monegasque citizen

Singapore	Great Britain	<ul style="list-style-type: none"> • Bureaucracy is next to nothing for entrepreneurs • common law is the legal system
Other European Tax havens		Ireland, Cyprus, Malta, Principality of Andorra, Gibraltar, Vatican, San Marino
Other tax havens of the United States of America		Nevada, Wyoming, Panama, Marshall Islands, US Virgin Islands
Oceania Tax Havens		Narau, Niue, Samoa, Tonga, Vanuatu, Cook Islands
Asia tax havens		Malaysia, the Philippines, Brunei, Dubai, Saudi Arabia, Qatar, Kazakhstan, United Arab Emirates, Kuwait, Hong Kong.
African Tax havens		Lebanon, Seychelles, Liberia, Kenya, Mauritius, Ghana, Morocco, Tunisia, Somalia, Angola, Djibouti.

Source: our elaboration on the OECD (The Organization for Economic Co-operation and Development) data

According to the International Monetary Fund (FMI), seeing as the phenomenon of money laundering is between 2 and 5% of the global gross domestic product (GDP) and that half of international capital flows pass through or is kept in those territories, it is assumable that the money in circulation is between 600 and 1500 billions of Euro. In addition the financial wealth of families and companies is kept in these tax havens. Gabriel Zucman economist of Berkeley University of California, through a transparent methodology, has estimated, that 8% of financial capital of families is kept in these tax havens. The financial asset is the wealth kept by natural persons in bank accounts, in the shape of shares and obligations in mutual funds and insurance contracts, after deducing the debts. In 2014, this capital amounted, at the global level, 87.000 billions of Euro; 6.900 of this amount should be kept in open accounts in tax havens. Thirty percent 30% of off-shore assets, 2.100 billions are located in Switzerland. The rest is scattered among Singapore, Hong Kong, Bahamas, Cayman Islands, Luxembourg, and other tax havens that offer banking and financial services to Billionaires of all over the world. Where does the wealth kept in these tax havens come from? The main part of 2400 billions of euro comes from Europe, 1050 billions from United States and 1200 from Asia. The remaining part from other nations. In Europe, 10% of families financial assets is kept offshore, in the United States 4%. The percentages are higher in the emerging and developing Countries. In Africa, the wealth kept abroad is around 30%. In Russia and middle east oil-producing Countries is more than 50%.

Beyond the fact that companies or individuals that keep their assets in tax havens, are not obliged to pay taxes, or just a small part, these privileged areas carry out a remarkable role in the economy of developed countries. Not all tax havens offer the same level of advantages: some do not apply any taxation; others mainly agreed a tax exemption for the companies which keep their assets on their territories; others, instead, agreed to do not tax residents. Corporations take advantage from this situation, that seems, sometimes, to be deliberately studied for them. Whereas the tax evasion is one of the segments of the market of the offshore centers, these areas easily attract those who wish to avoid to pay taxes for their assets and incomes. The holders of large private assets, such as companies and corporations, are considered as privileged clients for these marketplaces. The money flow of these marketplaces has a central role in the system of global finance.

Because of their legal vacuum and the tolerance of large States, tax and financial havens accept many other activities. The money coming from corruption seeks refuge in tax havens, through a two ways system: it becomes possible to bring out illicitly, the money used for the corruption, and make the money resulting from corruption get back. Some security companies, larger providers of contractors and weapons for any local conflict, can seek refuge here in total discretion. In the end, for some time now, but recently with a strongly increasing, these countries give to merchant fleets a nationality called "of convenience," in other words "a shadow flag" in order to take advantage, in low tax conditions, of ships whose safety is extremely dubious.

In short, tax havens represent, therefore, a requisite increasingly significant for the global economy, especially with an impact on developing countries on the basis of four main modalities:

- the research from private and companies to find a way to considerably elude or reduce the payment of the taxes due to contribute to public finances;
- in fiscal terms transnational corporations have a relevant competitive advantage compared to national companies because they are more able than national ones to structure trade exchanges and investments through fictitious subsidiaries in territories with privileged taxation. The competition between them is unequal, no matter if local companies are technically more efficient or innovative than transnational competitors. Basically, big companies will be favored to the detriment of small ones, as well as those international compared to those national. Whereas in the developing countries most of the companies are smaller and more recent and focused on their inner dimension compared to those of developed countries, this tax system partiality will illegitimately favor transnational companies of industrialized countries to the detriment of internal competitor companies of developing countries;
- the opportunity of a safe coverage to launder the proceeds coming from political corruption, fraud, scam, illegal arms trade, drug trade, through bank secrecy and trust services provided by globalized off-shore financial institutions. The lack of transparency of international financial markets contributes, in this way, to increase globalized crime, terrorism, corruption, as well as the embezzlement of resources from political and business elite;
- the instability of financial markets, mainly to the disadvantage of poor countries. Indeed, off-shore financial centers are used as a channel for rapid transfers of assets inside and outside national economies, destabilizing financial markets.

Trust, offshore companies, triangulation and creations of "international business companies" are some of the main tools provided for the potential clients of tax havens. Tricks and artifices are also related to accounting: normally, in case of evasion, clients keep an illegal accounting in an offshore server (a remote accounting that leaves no traces in the computer of the client). Sometimes it can be helpful the conventional regulation: a company that deals with trade of digital products on the web, for example, although it operates on a specific market, the server will be localized in a different country, with a privileged tax system, where this integrates stable organization, with a consequent attraction to a smaller imposition of incomes produced.

In this context, organized crime finds new fields to operate, assuming by now, the same specific peculiarities of a multinational enterprise, such as a significant liquidity, becoming in this way able both to compromise the economic system as a whole and to taint the business activities themselves (Becchi, Rey, 1994). Indeed tax and financial havens have a central role in the universe of illicit finance (assets that come from criminal and illicit activities), because they are "money laundering laboratories." These welcoming territories that launder and monetize dirty money of crime and corruption are the transparent prism through which the opacity of the illicit economy can be analyzed.

3. Tax evasion and elusion practices

The overview of tax havens is, therefore, quite complex and cannot immediately be identified because it is constantly evolving. The phenomenon, actually, seems to be increasing. In the last decade, during the financial crisis of 2007-2008, there was an increase of the so called "capital flight" towards tax havens. There are many people and several companies that try to hide their wealth completely or in part and mainly from public authorities (tax, financial, judicial, police). Usually it concerns incomes legally gained, but with the deliberate aim to escape from tax and social legislation: pay less taxes and hide profits. But on the other hand, it is about illicit incomes, came from arms trade, supply of mercenaries, drugs, prostitution, theft, racketeering, blackmail, smuggling and abuse of corporate assets.

Usually, within each national territory, these tax evasion and elusion practices occurred, taking the cue from legislative, administrative and judicial inadequacies. However these inadequacies have increasingly developed at the international level, also because of the lack of international organisms able to regulate, administrate and control, or rather exploiting the differences among national legislations. In a broad mobility condition of assets, disparities have turned into considerable advantages or disadvantages.

Tax elusion for multinationals occurs because of the gaps in the Law. In order to have an idea of its entity, we may consider that, in the United States, in 2013, companies made 650 billion of dollars of profits abroad. Half profits come from nations of a low or void tax imposition: Bermuda, the Netherlands, Luxembourg, Ireland, Singapore and Switzerland. The taxes evaded and eluded by corporations have been estimated, only for the United States, in 130 billions of dollars per year. Regarding 6900 billions of Euro of the assets that families keep in tax havens, according to Zucman, only 20% has been declared. The remaining 5.500 billions would escape, therefore, to taxation. The global loss of tax revenue amounts to 170 billion of euros, 30 for the United States and Asian countries, and 13 billion of euro for Africa.

Firstly this phenomenon is possible, through the suppression of currency controls and the free capital movements as well as the willingness of each State to attract mobile capital through articulated forms of *tax social and environmental dumping*. Moreover, this condition, takes advantage from recent technological developments: dematerialization of financial transactions; use of new means of communication; electronic currency transfers out of any control. In the end, the same evolution of the capitalism is the main cause of this trend: the creation of a single money market at the global level that let finance dominate all others economic sectors and to impose its influence on all human activities. The interconnections between bank systems and national financial markets have, therefore generated a global financial field. At the same time, national public authorities (Police, Justice, Revenue, Customs) actually remained, despite of many agreements and international conventions, confined within their respective national borders.

The developing of fraud and tax evasion is also the consequence, direct or indirect, of some political choices at the European level. Since 1992, governments of the European Union approved the total freedom of the circulation of assets without rapidly start a balancing process of tax systems and capitals and income taxation. This lack of balance, naturally pushed the owners of these assets to move them towards those European Union States which guarantee a low taxation. Recently this trend has crossed UE borders (even if some European Union States are real tax havens) involving other national entities that are specialized in these kinds of activities. The concern to attract mobile assets has brought about some States to adopt *tax dumping* policies. In order to finance national public expenditure, the tax burden on labour and income have been increased, extremely less mobile, causing an increase of internal social inequalities.

In the end, legal economy globalization has been followed by the globalization of criminal economy. Several criminal activities have been internationalized and their networks of relations have adopted a transnational logic. In the context of general economy, globalization through deregulation has facilitated also the integration of legal economy together with the criminal one causing serious social and economic consequences.

4. Money laundering

As already mentioned, criminal organizations easily break into the market assuming the characteristics of business activities where the connection between illicit and legal activities has been represented by money laundering, often through financial transactions connected to tax evasion and elusion. The tax evasion phenomenon and the money laundering coincide on the fact that they both locate illicit assets in tax havens. The interrelation between the legislation against money laundering and the one that aims at reducing the phenomenon of tax evasion it can be identified in the legislation of many OECD countries, which are progressively adapting their legislations to the measures identified by the FATF (International Financial Action Group) in the 49 recommendations, as well as the standards developed by the Global Forum on the subject of transparency and exchange of information on tax matters.

FATF has developed a model of laundering phenomenon, called “triphasic” because is composed by three phases:

- the first phase is represented by the *placement* of illicit assets, and it occurs through the introduction of these illicit capitals inside the financial system. The easiest and more common transaction consists to fractionate a significant amount of cash to obtain many little amounts, in order to make them less

- suspicious and more difficult to be identified when they are deposited on bank accounts;
- the second phase is the *layering* that consists, instead, in the subsequent movement of assets through a set of transactions (transfers, bank transfers, loans, payments) in order to hide the connection between the money and its illicit source. Practically it concerns to transfer these amounts on bank accounts of other marketplaces, particularly in those countries that do not collaborate with anti-money laundering inspections. These interbank transfers, therefore, start from the many bank accounts came about from the fractionated deposits and that are direct to a main collector account in an off-shore center. It is clear that uncontrolled electronic transfers facilitate these transactions;
 - in the last phase, in the end, called *integration*, financial resources are introduced in the legal economic cycle through investments in properties, luxury goods, companies or other. The introduction of funds in legal economic activities occurs through shell companies constituted in tax havens countries: real estate acquisitions; companies takeovers through stakes; purchases of companies, clinics, restaurant chains etc.. During the money laundering procedure can be involved: lawyers specialized in company law, accountants, notaries, real estate agents, insurance agents, trust companies, banks, financial institutions. It is estimated that a bank which operates in the field of money laundering, for instance, gains a source of income between 10% to 40% of the amounts paid for this purpose.

Different money laundering techniques are mainly applied through a double typology of transactions: on one side, those having a fictitious economic purpose that aim to dissimulate the illicit origin of the money; on the other, those transactions that aim to hide the real owners of the assets through figureheads. The first kind of transactions, for example, uses fake invoices to justify money transfers through fictitious imports, that can provide a justification regarding funds transfers to suppliers located abroad. The second type of transactions is, instead, carried out through a simulated negotiation with the purpose to hide the real owner of the wealth.

In both cases it is possible to detect similar techniques and patterns used for tax evasion: indeed, both the use of fake invoices and the fictitious use of intermediaries constitute an extremely diffused phenomenon in the field of evasion conducts. Therefore, criminal phenomena (and *firstly* the money laundering) and tax evasion are extremely connected.

Also for this, in the new community directive regarding anti money laundering is now expressively provided the reference to tax crime related to direct and indirect taxes. New anti-money laundering regulations, approved by the European Commission, jointly to the regulation regarding informative data of transfers of funds, in order to guarantee the "traceability," clarify, in fact, that anti-money laundering and evasion are more and more two sides of a coin. In fact, the Commission underlines that the inclusion of tax crimes linked to direct and indirect taxes is the result of the indications of the FATF (Financial Action Task Force).

Definitely, money laundering is useful and profitable for financial and economic crime and it is an important aspect in order to accelerate and expand global crime in the economy and finance. Moreover the complexity of this phenomenon has caused economic and social consequences: it contributed to accelerate the instability of international capital movements and currency prices and could destabilize the bank system. In the end money laundering put entire sectors under the control and the influence of organized crime altering the competition: companies can easily cut prices or even "producing at a loss," by virtue of the fact that their real financing comes from other sources. Actually, money laundering can put entire countries under the control of the organized crime.

5. International instruments against tax havens

The OECD struggle against the illegal use of tax havens officially started in 1998 with the publication of the Report named "*Harmful Tax competition- an Emerging Global Issue*," drafted following the request proposed by the Ministers of the member States to develop specific measures against the distorted effects of harmful tax competition on investments and financing decisions as well as on national tax bases. The first issue examined by the Report concerned the identification of the criteria in order to distinguish legal tax practices from harmful ones. The second one concerned the elaboration of a list of countermeasures summarized in nineteen recommendations that member states were invited to adopt in order to impede the diffusion of the phenomenon in question efficiently.

In particular, those recommendations aimed to increase the efficiency of the internal measures already adopted by the member states, avoiding the application of the international conventions that could favor harmful tax competition phenomena and eventually intensifying the international cooperation. The first recommendation concerns the introduction of an internal disposition regarding the CFC – Controlled Foreign Companies. Precisely, the Organization invited member states without any regulation regarding this issue to adopt the CFC rules or equivalent regulations as a possible solution for the harmful tax competition. Countries which are already provided by this regulation were instead invited to extend the implementation to all tax practices that could be considered harmful by the virtue of the criteria mentioned in the Report. The Report of 1998 ended with the commitment of the member States to avoid any measure that could be harmful as well as to remove, within 5 years from the date of the approval of the guidelines by the Council (within April 2003), all the harmful aspects present in their tax regimes.

On the basis of the previous indications, in June 2000, the OECD published a new Report named “*Towards Global Tax Co-operation*,” in which 47 tax regimes considered potentially harmful have been identified. In this mentioned Report was also published the first blacklist which includes 35 states or territories labeled as tax havens where the deadline for the removal was more urgent compared to the potentially harmful tax regimes. In particular, States were invited to send by 31 July 2001 an *advance commitment letter* that is a letter with which they committed to eliminating the harmful tax practice adopting new measures, and avoiding the introduction of new others, and ensuring an appropriate information exchange with foreign financial administrations. Moreover, the OECD requested a detailed plan where it was indicated the timing and the conditions through which the tax haven would have eliminated the harmful practice.

A determining change of direction occurred with the publication of the report “*The OECD’s Project On Harmful Tax Practice*” where the lack of a proper exchange of information became according to the OECD the main criterion to identify tax havens. According to the organization, in a now global economic context, each single government could not longer rely solely on information from internal sources to guarantee the fulfillment of the tax obligations by their taxpayers. Therefore, the exponential increase of transnational transactions made by these taxpayers requested a close collaboration of the different foreign tax administrations.

In the following Reports, remarkable progresses reached by the organization against the harmful tax practices were put into light. Following the publication of the first black list in 2000, in fact, States included in this list have promptly shown their willingness to remove any harmful tax practices in their tax systems. In particular in 2002 only seven of the thirty five Countries were again considered tax havens, subsequently reduced to five in 2003. As regards to potential harmful tax systems, instead, the Report of 2006 underlined that 18 of the 47 harmful tax systems initially identified were abolished, 14 modified and 13 considered more harmful after more accurate analysis.

After the publication of the Report “*Addressing Base Erosion and Profit Shifting*” in February 2013, OECD initiated a new international project to obstruct tax base erosion phenomenon through the fictitious transfer of incomes in tax havens. Unlike the previous reports, this project do not focus on the identification of the peculiarities of harmful tax practices, but rather, on what let corporations practice tax strategies particularly aggressive. In other terms, the attention of the Organization moved from the requisites that let a Country to attract foreign investments in its territory to the detriment of third countries, to the ways used by States to erode the tax base of their resident country through the fictitious transfer of incomes in tax havens.

The requirement to adopt a new action plan came about from the awareness that international tax regulations contained in each single legal system were not more adequate to regulate an economic system where interactions between different tax systems became more and more frequent. Up to then, therefore, member States planned their own tax system without taking into consideration the effects caused by the tax regulations of other foreign countries, because, in a closed economic context, cross- border transactions were rather marginal because of the insufficient mobility of the capital. Globalization process and the subsequent increasing of international exchanges have meant that existent *mismatches* between the different national legal systems caused numerous cases of double non-taxation, punctually used by multinational companies to reduce their tax burden. Recent studies in this matter

have in fact shown how tax plan schedules adopted by societies became by the time particularly aggressive because they were focused to transfer the produced wealth to locations with a particularly low level of taxation. Therefore, these strategies have caused a mismatch between the State where the incomes were produced and the State where these were effectively taxed. The project aimed to bring back the taxation of the profits in the Countries where the activities took place and where the added value was actually produced, so as to render ineffective those planning strategies that exploiting the obsolete rules and the scarce coordination between the different national tax systems, reducing the tax revenue of the single States. For this purpose, in July 2013, the organization published an international Action Plan composed generally by 15 actions that member states should have implemented within two years from the date of publication.

The 29th October 2014, in Berlin, G20 Countries and small off-shore tax havens, signed an historic agreement with regard to combating international tax frauds. All this, thanks to the commitment of the OECD. More than 90 Countries signed an agreement to pass to the automatic exchange of tax data about taxpayers around the world, including information such as for example having a bank account abroad, the collection of income or interest, the purchase of company shares. In 58 Countries it started from 2017, while in others 34 from 2018. Only Panama, Bahrein, Cook islands, Nauru and Vanuatu confirmed their refusal to conform themselves to this agreement. It was important, because among the signatories there were states or territories that up to then, were based on the policy of bank secrecy, such as Luxembourg, Austria, or off-shore centers often labelled for their lack of transparency, such as Cayman or Bermuda. It does not concern to a symbolic agreement, because it has obliged tax administrations to transmit data according to the OECD regulations regularly. This exchange mode would have improved the procedure, which was based on request of data only following administration or judicial investigations on subjects suspected of fraud.

In accordance with the developing of the OECD, also European Commission has recently reinforced the struggle against aggressive tax plan. On the 28th January 2016 the Commission, in fact, published a new anti-evasion package of measures with both legislative and non-legislative initiatives in order to impede aggressive tax plan and increase tax transparency to create in the European Community a more fair context for companies. Particularly remarkable is the Council Directive that contains regulations against tax evasion practices that directly have an impact on the internal market² (so called “*Anti Tax Avoidance Directive*” or ATAD), adopted by the Council on the 12th July 2016. The objective of the provision is to facilitate the implementation of the recommendations disposed by the OECD in the European Community. In particular the Directive introduced specific disposals in matter of:

- deductibility of the interest expenses (art.4). This regulation aims to prevent the fictitious transfer of intra group debts in Countries where more favorable deductibility regulations are applied;
- outbound tax (art. 5). The purpose of this provision is to discourage the transfer of the tax residency of tax payers and/or their assets in low taxation countries solely in order to reduce the due tax burden;
- general anti abuse clause (art. 6). This provision is intended to fill any possible gap in the anti-abuse regulations in force;
- foreign subsidiary companies (art. 7 and 8). The regulation aims to prevent the affected transfer of profits to low taxation jurisdictions, exclusively to obtain a remarkable tax saving and divert the taxation of the country of residence;
- Hybrid mismatches (art. 8). This provision is meant to avoid those practices that through the mismatch of national tax systems they obtain situations of double non-taxation.

With regards to the implementation, member States must apply the Directive by 31 December 2018.

As previously mentioned, among the regulations contained in the recent Directive, also those regulations related to CFC are included. In particular, the measures contained in articles 7 and 8 of the mentioned provision can be applied to tax payers which, alone or jointly to subsidiary companies, hold in the foreign company a shareholding able to guarantee them the majority of the voting rights, to the capital namely to the profits. Therefore, the

² Directive n.2016/1164 EU on the 12th July 2016.

forementioned provision, includes, in the subjective context of the implementation of the regulation, both the cases of control of law and those cases related to economic control, in accordance with OECD recommendations.

6. Conclusions and open issues

In the light of this, we can affirm that the most dangerous issue of tax havens is represented by the real risk that large amounts of money made through business activities and transferred to tax havens in order to evade taxes once they reached bank vaults of these countries, these amounts can be confused with other available funds obtained by illicit activities (more criminal compared to tax evasion), creating new money laundering forms and other criminal practices, until the traces and the origin of financial transactions go lost. The development of the tax havens issue has been described from some recent events that involved global economy in the last years. For instance, the case "*Panama Papers*," although it has not been defined, it seems to show how recurring to tax havens has been not only a way to pay less taxes but also an instrument to hide remarkable accounting and financial statement fraud. Recent events that have involved important and consolidated industrial and financial corporations have pointed out how national control tools can be insufficient to prevent and fight against criminal phenomena perpetrated on international financial markets.

The advent of Internet and the e-commerce, in this context, has promoted new opportunities but also generated complexity. It has been noted how these instruments can be, on one side, a real and not "virtual" help to money laundering, and, on the other, an additional and dangerous obstacle for competent national authorities to control and fight against these activities. Moreover, considering the problematic peculiarities connected to the e-commerce, if this activity is managed by a company located in an off-shore center we could talk about "haven within haven," where the guarantees for the launderers are integrated and strengthened, creating an invincible juridical stronghold.

During the year, governments, being aware of this situation, have started to promote coordinated international activities to fight against money laundering through combined and common measures. Conventions have been stipulated with States included in the so-called *black list* in order to trade according to correct parameters and to demonstrate a greater sense of responsibility from financial institutions. However, up to now, some bank and financial off-shore systems continue to practice secrecy and confidentiality policies.

Several initiatives have been carried on at the international level, in order to obtain some successes regarding information exchanges, impeding that loyalty policy practiced by banks during the transfer of assets toward tax havens. The European Union established the principle of automatic exchange of information through Saving Tax Directive, and it has indicated a global model for the cooperation in tax matter. Also the OECD, independently, focused on procedure and systems of information exchange between national tax authorities. The outcome is unequivocal, there is the necessity of an international tax organization that mainly can ensure minimum standards of transparency and cooperation among states, in order to limit negative global implications came about from internal tax system, such as those of tax havens. In this regards many proposals have been carried out by experts and international organizations. Among these we can essentially mention three:

- i. the creation of "*a global register of financial assets that registers the owners of all outstanding shares and bonds.*" This would be a register, accessible to all tax authorities of the countries, indicating who owns the financial securities, shares, bonds and shares of mutual investment funds in the world. The International Monetary Fund could be the Authority able to have the technical skills to make it work in the medium term;
- ii. the provision of "*sanctions proportionate to the cost that tax havens impose on other countries,*" possibly imposing customs duties on those countries with privileged taxation that do not assume cooperative behaviors;
- iii. "*the review of corporate taxation*" based on consolidated profits around the world and not on profits Country by country.

Ultimately the fight against the phenomena just mentioned and, therefore, against crime encounters many obstacles. It is relatively easy to demonstrate how numerous proposals and concrete solutions exist but that the open questions remain mostly devolved to the governments and the national and international *decision-makers*.

As extensively demonstrated, financial globalization has favored the interweaving of licit and illicit economies, especially in those places outside the law that are financial havens. The rights of nations and people have not longer say in the matter, in these territories, because the most powerful states were those who have tolerated or favored their development. The most effective solutions can, therefore, be found only by carefully considering the fact that the issue of crime and tax havens is a purely "political" issue.

References

- Ardizzi G., Petraglia C., Piacenza M., Turati G. (2012), Measuring the underground economy with the currency demand approach: a reinterpretation of the methodology, with an application to Italy (Working papers), Banca d'Italia, N. 864 - April;
- Becchi A. – Rey G.M. (1994), *The criminal economy*, Laterza, Rome – Bari;
- Caramognoli G. (2011), *Main Outlines of law enforcement action*, in Black list and tax havens, Rimini, MAGGIOLI Editore, p. 13.
- Carbone M., Bosco M., Petese L. (2015), *Tax havens geography*, IPSOA Manuali, Wolters Kluwer, Milan;
- Catalano I. (2011), Dossier on *Organized Crime and tax evasion, the fight against tax evasion as an instrument against organized crime and to the diffusion of activities formally legal*. *Instruments Res*, Year III, N. 4, October;
- Daniele V. (2017), *Tax havens and globalization. Notes on the hidden wealth of Nations. Tax havens inspection*, by G. Zucman, Ed. ORDINES, ISSN 2421-0730N. 1 – June;
- European Union Directive n. 2016/1164 UE of the 12th July 2016 containing regulations against tax elusion practices that directly have an impact on internal market;
- Gara M., De Franceschis P. (2015), *Tax havens: operative peculiarities, empirical evidence and financial anomalies*, Banca d'Italia, Financial Information Unit for Italy, Anti Money Laundering Notebooks, n. 3;
- Gourguechon G. et al. (2001), *Tax havens, Outlaw finance*, curated by ATTAC France, ASTERIO Ed., April;
- GUARDIA DI FINANZA (ITALIAN FINANCE POLICE) – Scuola di Polizia Tributaria (Italian Tax Police Academy) (2008), *Economic, financial and criminal profiles in the international context: analysis of some countries in the area of Central and South America*, curated by Officials of the 35° Advanced Course of Italian tax Police Academy, 2007 – 2008;
- ISTAT (2017), *Report on the unobserved economy and on tax and social security evasion, Year 2017* (art. 10-bis.1 c. 3 Law 31st December 2009, n.196), ISTAT (Italian National Statistics Institute);
- Leo M. (2006), *Income tax in the Consolidate Law*, Giuffrè, Milan, p. 2100;
- OECD (Organization for Economic Cooperation and Development) (1998), Report “*Harmful Tax competition- An Emerging Global Issue*”. Available at: <https://www.oecd.org/tax/transparency/44430243.pdf>;
- OECD (2001), Report “*The OECD’s project on harmful tax practices: the 2001 Progress Report*”. Available at: <https://www.oecd.org/ctp/harmful/2664450.pdf>;
- OECD (2006), Report “*The OECD’s project on harmful tax practices: 2006 update on progress in member countries*”. Available at: <https://www.oecd.org/ctp/harmful/37446434.pdf>;
- OCSE (2015), Report “*Designing Effective Controlled Foreign Company Rules*” in ACTION 3: 2015 Final Report. Available at: <http://www.oecd.org/ctp/designing-effective-controlled-foreign-company-rules-action-3-2015-final-report-9789264241152-en.htm>;
- Parisi A. (2004), *Markets, companies and banks – Structure and functioning*, Giuffrè Editore, Milan;
- Razzante R., Palumbo G. (2014), *Organized Crime, money laundering and tax evasion: from Al Capone to Sciascia, up to “redditometro” (method of assessing income)* Cap. I, Vol. *The new frontiers of financial crime. Tax evasion, frauds and money laundering*, Filodiritto Editore, Bologna, March;
- European Parliament Resolution of 11 June 2013 regarding organized crime, corruption and money laundering: recommendations regarding actions and initiatives to be taken (interim report) (2012/2117(INI)) (2016/C 065/03), GUCE C 65/16;
- Shaxson N. (2014), *Treasure islands: A journey to tax havens where globalization treasure is hidden*, Feltrinelli;
- Zucman G. (2017), *The hidden wealth of the Nations. Tax havens investigation*, add editore, Torino, 2015 (con prefazione di T. Piketty). N.1.



Building Acceleration of Economic Growth Model Through Education and Health Budget Allocation: Cases in Indonesia

Hasyim¹, Rina Anindita², Baharudin³, Gunawan⁴

^{1,2}Esa Unggul University , Jakarta, Indonesia. Email: Rina.anindita@esaunggul.ac.id

^{3,4}STIE AMKOP, Makassar, Indonesia

Abstract

The Role of Capital Expenditure on Education, Health Expenditure, on the effort to reduce poverty level is an interesting study because the allocation of expenditure to several countries including Indonesia is quite large, so it is necessary to review the effectiveness of the budget allocation to reduce poverty and increase human economic growth (Psacharopoulos, 1972) in Todaro, 2000). The level of public welfare can no longer be measured from monetary values such as income per capita, but should include non-economic measures (Connolly and Munro (1999); Perkins (2001); Todaro and Smith (2002); and Van Den Berg 2005), and more focus on human development which can be measured from the high government commitment in allocating budget for education, health and other factors which are strongly related to the development of human resources. The objectives of this research are to analyze and assess on how: (i) the impact of the allocation of education capital expenditure and the allocation of health expenditure on the Human Development Index; (2) the influence of human development index on economic growth; (3) the effect of economic growth on the level of poverty; and (4) the interpretation of the economic growth acceleration model. The research was conducted by taking samples in 23 regencies/municipalities in South Sulawesi Province which is one of the provinces with the highest economic growth rate in Indonesia. The data used is Panel data with period 2004 - 2016, then processed by using regression analysis method. The Result of the Research from the first model., it shows that from the t test, it is found that the variables contained in the data which give significant effect to the Human Development Index is the allocation of Education fund, at the real level of 5%. The value of R2 generated in this model is 0.637 which means that 63.7% of the human development index in 23 urban districts for 10 years is explained by the variables in the model, the allocation of education and health funds, the rest by other variables in the model. The variables in the allocation of education funds have a negative influence on the human development index. The value of regression coefficient of this variable is 0.72 with p-value of 0.003. meaning that any 1% increase in health allocation funds will reduce the human development index by 0.72. For the panel data analysis with this random effect model there are individual and time effects that show differences in human development indexes between districts and municipalities and between years. So the value of constants to be obtained will be different for each district/municipality and different for each time. The determinant coefficient value generated in model 1 shows the figure of 0.637 means that 63.7% of the human development index is explained by the variables in the model, i.e. the allocation of education and health funds. In model 2 it was found that the value of determinant coefficient is 0.0854, which means that only 8.5% of the diversity of economic growth in the twenty three districts/municipalities in South Sulawesi in the period 2007-2016 explained by the variables on the human development index.

Keywords: Education Budget Allocation, Human Development Index, Economic Growth, Developing Countries

INTRODUCTION

The problem of poverty in Indonesia has always been the main concern, as the government has realized that failure to overcome the problem of poverty will lead to the emergence of various social, economic, and political issues within the community. Over the last few decades Indonesia's economic growth has experienced ups and downs in accordance with world economic conditions, where the national income which is the benchmark of economic growth shows fluctuating growth

According to Mankiew (2008), human resource development can be done through improving the quality of human capital. Human capital that refers to education and health is a fundamental development objective in a region, namely education is essential to achieve a decent life, while health is the core of prosperity. Improving the quality of human capital depends on the availability of infrastructure to support investments in human resources, such as housing and transportation, which are public goods provided by the government in order to meet the needs of the community.

The allocation of local government expenditures reflected in the Regional Budget (APBD) will have a positive impact on human development as well as economic growth, primarily the allocation of direct spending on education, health and infrastructure. These three direct expenditure allocations will be outlined in personnel expenditure, goods and services expenditures, and capital expenditures, indicating that personnel expenditures and goods and services expenditure are incapable of contributing to human development and economic growth, and only capital expenditures is capable of responding to human development and economic growth.

Connolly and Munro (1999); Perkins (2001); Todaro and Smith (2002); and Van Den Berg (2005), similarly offer a measurement of the achievement of economic development objectives on more abstract matters relating to the social, cultural and economic aspects of society which focus more on the level of human development progress.

In the essence that development is human development, so it needs to be prioritized that the allocation of spending for this purpose lies in the preparation of budget (Adi, 2009). Human development can be observed through the size of the Human Development Index (HDI), where HDI is one way to measure the level of physical and non-physical qualities of the population. Physical quality is reflected in life expectancy, while non-physical (intellectual) quality through the average of school attendance and literacy rate, as well as the economic capacity of the community as reflected in the purchasing power value of parity index.

Based on these perspectives, there is a need for in-depth and systematic study on the performance of regional development policies through the implementation of local expenditure allocations to reduce poverty levels through HDI and economic growth. Conceptually the development approach puts development policy in a strategic and important position in development acceleration. This can be spelled out in more effective and efficient regional fiscal policies that can directly address the basic needs and requirements of the community through the allocation of local spending for public services and the construction of basic community infrastructure.

Empirically, there have not been many studies that specifically verified and estimated capital spending capabilities of education, health, and infrastructure in APBD in reducing poverty through economic growth in response to human development, and Social Overhead Capital (SOC) especially the regencies/municipalities in South Sulawesi. Thus, local development policy makers do not have sufficient scientific references in allocating their APBD expenditures appropriately to reduce poverty, aimed at increasing the acceleration of economic growth.

The objectives of this research are (i) to analyze and examine the effect of allocation of education capital expenditure and health expenditure allocation to Human Development Index in South Sulawesi Province; (2) analyze and test the effect of HDI on economic growth in South Sulawesi Province; (3) analyze and examine the effect of economic growth on poverty level in South Sulawesi Province; and (4) interpretation of the economic growth acceleration model.

LITERATURE REVIEW

Education and Health Expenditure with Development Index

The allocation of spending on education and health is an instrument for improving the quality of human resources, which in turn impacts on poverty alleviation. As Sepulveda, 2010 states that pro-poor government spending is the allocation of basic health spending and basic education. This is because good education and health enable the poor to increase the value of their assets because their most important asset is their labor (Lanjouw, Pradhan, Saadah, Sayed, and Sparrow, 2001).

According to Todaro (2006), education and health are the fundamental development goals, to form broader human capacities that are at the heart of the meaning of development. On the other hand, poor communities who generally have no resources except energy capital, health becomes the most essential need. Health and education can be seen as a vital component of growth and development and an input of an aggregate production function. Its double role as input and output causes health and education very important in economic development.

Improvements in education and health will affect human development outcomes. Considering that indicators in the human development index (HDI) by UNDP put education and health as the main indicators in addition to economic indicators. Psacharopoulos (1972) in Todaro (2000) proves that education does have a positive influence on the development of economic growth. Improving health, education and nutrition is not only able to increase the capability, but also an important means in improving "human capital" in the future.

Human Development (IPM) Against Economic Growth

Human capital is one important factor in the process of economic growth. It can be believed that the economic performance will be better if human capital is qualified, in this case shown in the level of education, health, or other indicators as can be seen in various human development reports published by the United Nations Agency for Human Development (UNDP).

Thus, economic development should be considered in order to spur economic growth, including in the context of regional economies. This is important because development policies that do not encourage human quality improvement will only make the area concerned lag behind other regions, including in terms of its economic performance. Furthermore, improving the quality of human capital is also expected to provide benefits in reducing imbalances between regions, especially countries that have a wide area and a high level of socio-economic diversity.

High human development will be achieved as a result of stable economic growth conditions, through which economic growth will create health and education services, and open employment opportunities for the population. Conversely, high achievement of human development will encourage stable economic growth, which human development will create a qualified workforce, the birth of technological innovations, and trusted management.

Economic Growth and Poverty Rate

The Neo Classics pioneered by Solow who initiated the early model of economic growth (Solow Growth Model) argue that how savings, population growth and technological advances affect the level of economic output and growth over time. The Solow model is based on a production function that relies on capital and labor stocks, then assumed to have a constant scale return, so as not to affect the relationship between output workers and working capital, if the size of the economy is measured by the number of workers. Furthermore, (Lin, 2003; Bourguignon, 2004; Ravallion, 2005; and Warr, 2000, 2006) argue that high economic growth will enlarge economic capacity (Gross Domestic Product). High GDP is expected to create trickle down effect so that the welfare of society will increase, and will ultimately reduce the level of poverty, or better known as pro-poverty economic growth.

The concept of pro-poverty growth was first introduced in the 1950s and later confirmed by Chenery in 1974. (Kakwani and Pernia, 2000). Furthermore, it is implicitly described in the World Development Report 1990 (World Bank, 1990). Furthermore Bigsten and Levin (2000) argue that successful countries in growth are likely to succeed in reducing poverty, especially if there is appropriate policy support and institutional environment. Dollar and Kraay (2002) say that growth will provide far greater benefits for the poor if growth is accompanied by policies such as law enforcement, fiscal discipline, openness in international trade, and poverty alleviation strategies.

RESEARCH METHODS

Data

The data in this study are collected from 23 regencies/municipalities in South Sulawesi Province covering 20 districts and 3 cities, during the period of 2004-2014. This study uses pooled data by combining 23 districts/municipalities cross-section data and 11-year time-series data. Because the relationship between variables in this study is time-lag, the observation period for exogenous variables (predictors), which in this case the allocation of capital expenditure (education, health, and infrastructure) in APBD earlier in the year (t-1), both on the initial and final period of observation, while human development, social overhead capital, and economic growth, which is the endogenous variable (intervening), and the poverty level which is the endogenous variable (dependent) is the actual year period (t). Year 2004 was chosen as the initial observation for exogenous variables, and 2014 as the final year of observation for endogenous variables.

Data Analysis Method

Methods of data analysis using panel data regression, with several models built. In the first model the factors that determine the Human Development Index, with the variables of educational expenditure and health expenditure. The first model built is as follows

$$Y_{it} = \alpha + \beta_1 x_{1it} + \beta_2 x_{2it} + \mu_i + \gamma_t + v_{it}$$

With

- i : 1, 2, ..., 23, shows number of districts/municipalities in South Sulawesi
- t : 1, 2, ..., 10. time period under study *2007- 2016
- α : Interception coefficient
- β_1, β_2 : Slope Coefficient
- μ : The specific influence of the individual no.-
- γ : Effect of time t
- v_{it} : Effect of error on the i-th district/municipality and time t
- Y_{it} : Dependent variables (Human Development Index) for i-district and time-t
- x_{1it}, x_{2it} : The independent variable (Education and Health fund) for the i-th district and the time t

Second model is the factor that determines the rate of economic growth, with the variable is determined as Human Development Index.

The second model is

$$Y_{1it} = \alpha + \beta_3 Y_{it} + \mu_i + \gamma_t + v_{it}$$

- Y_{1it} : Dependent variable (Economic Growth) for district i and time t
- Y_{it} : The independent variable (Development Index) for the i-th district and the t-th time

The third model is the factor that determines the level of poverty, with the variables are the level of economic growth and Human Development Index.

The Third Model is

$$Z_{it} = \alpha + \beta_4 Y_{1it} + \beta_5 Y_{it} + \mu_i + \gamma_t + v_{it}$$

Z_{it} : Dependent variable (Poverty Rate) for district i and time t
 Y_{it}, Y_{1it} : Independent variable (Human Development Index and Economic Growth) for the district i and time t

After the model is made, then we proceed with the appropriate model specification for the three models, with the following stages:

1. Chow test, to test whether there is influence between individual and time. Chow test is done twice, the first to test whether there is an individual influence on the model used, with the following hypothesis:

$$H_0: \mu_1 = \mu_2 = \dots = \mu_{N-1} = 0$$

$$H_1: \text{at least there is one } i \text{ so } \mu_k \neq 0$$

The second is to test whether or not there is a time influence on the model used, the hypothesis test is as follows:

$$H_0: \gamma_1 = \gamma_2 = \dots = \gamma_{N-1} = 0$$

$$H_1: \text{there is at least one } t \text{ so } \gamma_k \neq 0$$

If from the second hypothesis testing it is obtained that H_0 is not rejected, then the appropriate model has no influence of time and individual from the model, as follows:

$$Y_{it} = \alpha + \beta_1 x_{1it} + \beta_2 x_{2it} + v_{it}$$

If in the first hypothesis H_0 is rejected, and in the second hypothesis H_0 is not rejected, then there is an individual influence on the model:

$$Y_{it} = \alpha + \beta_1 x_{1it} + \beta_2 x_{2it} + \mu_i + v_{it}$$

If the first hypothesis H_0 is not rejected and the second hypothesis H_0 is rejected, then there is a time influence on the model:

$$Y_{it} = \alpha + \beta_1 x_{1it} + \beta_2 x_{2it} + \gamma_t + v_{it}$$

If in the first hypothesis H_0 is rejected and in the second hypothesis H_0 is rejected, then there is the influence of both individual and time on the model, so that the model is formed as follows::

$$Y_{it} = \alpha + \beta_1 x_{1it} + \beta_2 x_{2it} + \mu_i + \gamma_t + v_{it}$$

2. Testing violations of assumptions, lack of correlation using Durbin Watson test, normality by looking at the standard leftover graph, and non-multicollinearity by looking at the value of Variance Inflation Factor
3. Model evaluation and Interpretation of coefficients

RESULT AND DISCUSSION

Result of Model Testing 1

The first model, with dependent variable is the human development index, the independent variables of education and health funds. The first model specification, for the first stage of the CHOW test, is performed to select the appropriate model, between the combined model, the individual fixed influence model or the fixed influence model of time. Chow test uses statistics F. In the first Chow test is a hypothesis to test whether there is influence of individuals on the model used. The result obtained is the -p value of the statistic F less than 0.05, so H_0 is rejected, which means that in this model there is an individual influence. Continued on the second hypothesis for the Chow test, the p-value obtained from the static F test is also less than 0.05 so that the second hypothesis is rejected, meaning in the model there is the effect of time. These results can not be determined whether the right model is the model of individual fixed influence (Fixed Effect) or the model which is influenced by time (random effect). The model specification is proposed by using Hausman Test to determine whether the appropriate model is a model with Fixed Effect or model with Random Effect.

Hausman Test, using the following hypothesis:

H_0 : there is at least one t so $\gamma_k \neq 0$ (Random Effect)

H_1 : at least there is one i so $\mu_k \neq 0$ (Fixed Effect)

The Hausman test uses the statistical value of F Test. The result of the test for this model, the obtained value of p from the statistic F is 0.8306 or greater than 0.05 so that H_0 is not rejected, it means that the correct model for the first model is Random Effect. It estimates that the data on panels may be interconnected between time and between individuals. In the random effect model, interdependent differences are accommodated by the error terms of each district/municipality. By seeing that in the first proper model is the random effect, the built equations do not need to test the heteroscedasticity, since the advantage of the random effect model has eliminated the problem of heteroscedasticity and auto correlation.

After going through various stages of testing, it has been obtained that the appropriate model is the model of random influence, as follows:

$$Y_{it}(\text{Human Development Index}) = \alpha + \beta_1 x_{1it} + \beta_2 x_{2it} + \mu_i + \gamma_t + v_{it}$$

$$Y_{it}(\text{Human Development Index}) = (\mu_i + \gamma_t) - 90.228 - 0.196 \ln X_1 - 0.72 \ln X_2 + v_{it}$$

The model illustrates the effect of variables in 23 districts/municipalities in South Sulawesi from 2007 to 2016. Based on the F test it has been achieved that p -value for F statistics is 0.000. This shows at the real level of 5% that there is at least one independent variables in the model that significantly influence the Human Development Index.

As for the t test, it is found that the variables contained in the data which give significant influence to the Human Development Index is the allocation of Education fund, at the real level of 5%. The value of R^2 generated in this model is 0.637 means that 63.7% of the human development index in 23 districts/municipalities for 10 years which is explained by the variables in the model, i.e. the allocation of education and health funds, as much as any other variables in the model. The variables in the allocation of education funds have a negative influence on the human development index. The value of regression coefficient of this variable is 0.72 with p -value of 0.003 meaning that any 1% increase in health allocation funds will reduce the human development index by 0.72. For the panel data analysis with this random effect model there are individual and time effects that show differences in human development indexes between districts and municipalities and between years. So the value of constant to be obtained will be different for each district/municipality and the value is different for each time.

Model 2 Test Results

Second model, with economic growth rate as dependent variable, independent variable of human development index. The first model specification, for the first stage of the Chow test is performed to select the appropriate model, between the combined model, the individual fixed influence model or the fixed influence model of time. Chow test uses statistics F. In the first Chow test there is a hypothesis to test whether there is influence of individuals on the model used. The result obtained is the p value of the statistic F is less than 0.05, so H_0 is rejected, which means that in this model there is an individual influence. Continued on the second hypothesis for the Chow test, the value obtained p is 0.007 from the static test of F which is also less than 0.05 so that the second hypothesis is rejected, meaning that the model is the effect of time. These results can not be determined whether the right model is the model of individual fixed influence (Fixed Effect) or the model is influenced by time (random effect). For that we do not need a model specification by using Hausman Test.

The second model is Fixed Effect. This model assumes that individual differences, in this study means each district/municipality, can be accommodated from different interceptions. Nevertheless the slope is the same for the inter district/municipality. But with the Fixed Effect model must pass Autocorrelation test. Autocorrelation test uses Wooldridge test for panel data, the result is the value of p for F test of 0.43 or above 0.05 means that this data is independent from autocorrelation problem.

After going through various stages of testing, it was found that the appropriate model is the model of random influence, as follows:

$$Y_{1it} = \alpha + \beta_3 Y_{it} + \mu_i + v_{it}$$

$$Y_{1it}(\text{Economic Growth}) = \mu_i - 20.878 - 0.199Y_{it} + v_{it}$$

The model illustrates the effect of independent variables for 23 districts/municipalities in South Sulawesi on Economic Growth in the period of 2007-2016. From t test it is found that the human development index variables give p-value of 0.000 at 5% real level. Thus, the human development index is a variable affecting the rate of economic growth. The value of R2 is 0.0854, which means that only 8.5% of the diversity of economic growth in the twenty-three districts/municipalities in South Sulawesi in the period 2007-2016 can be explained by the independent variable of the human development index, while the rest is explained by other variables outside the model. The human development index has a negative influence on economic growth. The coefficient value of this variable is -0.199 with a p-value of 0.000, meaning that any increase in 1 index of human development will decrease economic growth by 0.199%.

For the analysis of panel data with this fixed effect there are individual effects showing different economic growth between districts/municipalities based on the model specifications used, the constant values held by each district/municipality remain at all times observed and the value is different for each district/municipality.

Discussion

In general, the economic growth of the regencies/municipalities of South Sulawesi Province in the last five years (2009-2013), shows that the economic growth is quite high, even exceeding the national economic growth, which grows on average 7.32 percent per year and grows by 1.5 percent during the period of 2009-2013, where in 2009 the economic growth of South Sulawesi experienced 6.43 percent increase to 7.93 percent in 2013. The problem is the allocation of education funds and the allocation of health funds based on the results of statistical calculations using panel data, shows that the variable is negatively correlated. With the index of human resource development, in other words, the change of education fund allocation and health funding is inversely proportional to the development of human resources

The cause of this is probably due to unfulfilled macro assumptions in the implementation of allocated funds. According to Mankiw (2008) human resource development can be done through the improvement of the quality human capital that refers to education and health as a fundamental development objective in a region, namely education is essential to achieve a decent life, while health is the core of prosperity. Barro and Sala-i-Martin (2004) introduced an endogenous model that emphasized the importance of fiscal policy to foster economic growth that ultimately leads to poverty. The neoclassical model, in general, emphasizes the supply of labor, capital stock and technological change in the process of economic growth, which later developed into a human capital model in economic growth

Research Findings

The results showed that in model 1, there was a negative correlation between the variables of the allocation of education funds and the allocation of health funds to the human development index variables. This means that the increase in the allocation of education and health funds actually saw a decrease in the human resource development index, this finding is contrary to the theory used which states that supplementary allocations of education and health funds should encourage an increase in human development index.

Similarly in model 2 there is a negative effect between human development index variables on the rate of economic growth in South Sulawesi Province. This means that in the event of a decline in the human development index on the other hand there is economic growth. This condition indicates a paradox on factors that should run linearly between indices of human development and economic growth. A further hypothesis of this paradox is that there are assumptions that are not included in the calculations such as the assumption that an increase in the human

development index leads to an increase in the level of consumption ultimately prompting the Demand Pull Inflation.

CLOSING

Conclusion

In model 1 the allocation of education funds and the allocation of health funds are negatively correlated with human development index. In Model 2 human development index is also negatively correlated with economic growth. Thus it is concluded that the findings of this study need to be followed up by incorporating new assumptions such as budget allocation control factors to maintain effectiveness at budget allocations.

The results show that the right model to see the effect of education and health fund allocation on human development index is random effect model and to see the effect on economic growth and poverty rate we can use fixed effect. Further results indicate that the allocation of education funds has an impact on the human development index. The human development index affects economic growth and high economic growth will reduce poverty levels.

Suggestion

The allocation of education funds and health funds as an effort to improve and develop human resources should be done through the improvement of the supervision of allocation of funds in order to target the right, then the importance of fiscal policy to encourage economic growth which ultimately leads to the level of poverty. Assumptions that need to be considered are the provision of labor, capital stock and technological changes in the process of economic growth, which later developed into a human capital model in economic growth. In further research it is necessary to consider other variables that lie outside the scope of this study, such as the effect of huge infrastructure spending.

References

- Adams, Richard H. Jr, 2003. Economic Growth, Inequality, and Poverty: Finding from a New Data Set, Policy Research Working Paper #2972, World Bank, February.
- Ahluwalia, Montek S, dan Hollis B. Chenery, 1979. Growth and Poverty in Development Countries, *Journal of Development Economics*, Volume 16 September 1979, pp. 298-323.
- Anand, S. and Sen, A. 2000. Human Development and Economic Sustainability, *World Development* 28 (12): 2029-2049
- Balisacan, A. and Pernia, E. 2002. Probing Beneath Cross-national Averages: Poverty, Inequality, and Growth in the Philippines
- Balisacan, A., E.M. Perina, dan A. Asra, 2003. Revisiting Growth and Poverty in Indonesia: What do Subnational Data Show? *Bulletin of Indonesia Economic Studies*, Volume 39, Issue 3, December 2003.
- Barro, R.J., 1990. Government Spending in A Simple Models of Endogenous Growth. *Journal of Political Economy*.
- Barro and Sala-i-Martin 1990, "Public Finance in Models of Economic Growth" WP No 3362, NBER
- Barro, R.J., and Sala-i-Martin, 2004. *Economic Growth* 2nd Edition. London. England. The MIT Press Cambridge, Massachusetts.
- Bigsten, A., & Levin, J. 2001. Growth, income distribution, and poverty: A review. World Institute for Development Research Discussion Paper No. 2001/129
- Boex, Jameson, dkk, 2006, Fighting Poverty Through Fiscal Decentralization
- Cheyne Christine, O'Brien Mike and Belgrave Michael, 1998. Book Review: *Social Policy in Aotearoa/New Zealand: A Critical Introduction*. Article January 1998.
- Christy, Rhino Andrea & Adi, Priyo Hari. 2009. Hubungan Antara Dana Alokasi Umum, Belanja Modal, dan Kualitas Pembangunan Manusia. The 3rd National Conference UKWMS page 14. 10 Oktober 2009: Surabaya
- Connolly, Sara and Alistair Munro. 1999. *Economics of The Public Sector*. New York: Prentice Hall

- Danielson, Anders, 2002. Poverty, Inequality, and Growth in Jamaica, 1988-1998, and Beyond, Paper was presented at the IIIrd CEISEL conference, Amsterdam, July 3-7, 2002.
- Demombynes, Gabriel and Johannes G. Hoogeveen, 2004. Growth, Inequality and Simulated Poverty Paths for Tanzania, 1992-2002, The World Bank, Policy Research Working Paper #3432, October.
- Devarajan, S., Saroop, V., and Heng-fu Zou, 1996. The Composition of Public Expenditure and Economic Growth. *Journal of Monetary Economics* 37:313-344.
- Dollar, David and Aart Kraay, 2002. Growth is Good for the Poor, *Journal of Economic Growth* 7(3): 195-225.
- Gupta, and Mitra, 2004, Economic Growth, Health and Poverty: An Exploratory Study For India, *Development Policy Review*, 2004.
- Hayek F 1945, "The Road to Serfdom" The Institute of Economic Affairs
- Jafarov, Etibar dan Gunnarsson, Victoria. 2008. Government Spending on Health Care and Education in Croatia: Efficiency and Reform Option. IMF Working Paper
- Jhingan, M.L, 1999. *Ekonomi Perencanaan dan Pembangunan*. Jakarta : Raja Grafindo Persada.
- Kaldor, N. 1970, The Case for Regional Policies, *Scottish Journal of Political Economy*, Vol. 18 pp. 337-348. Reprinted in *Scottish journal of Political Economy*
- Klasen, Stephen. 2005. Measuring Poverty And Deprivation In South Africa. *Review of Income and Wealth* Volume 46, Issue 1, pages 33-58, March 2000
- Knowles, Stephen and Owen, P. Dorian. Education and Health in an Effect-Labour Empirical Growth Model. *The Economic Record* Vol. 73. No. 223. 1997.
- Kodoatie, R.J. 2003. *Manajemen dan Rekayasa Infrastruktur*. Pustaka Pelajar, Yogyakarta.
- Koopmans TC 1963, "On the Concept of Optimal Economic Growth" Discussion Paper no 163, Cowles Foundation, Yale University
- Koutsoyiannis A 1982. "Modern Microeconomics, second edition" The Macmillan Press, London
- Kuznets, Simon, 1955, *Modern Economic Growth : Structure and Spread*. London : Yale University Press
- Lanjouw, P, M Pradhan, F Saadah, H Sayed. R Sparrow, 2001 *Poverty, Education and Health in Indonesia: Who Benefits from Public Spending?* World Bank Working Paper No 2739 Washington D C.: World Bank
- Lee, Jong-Wha. 2005. "Economic Growth and Human Development in The" www.hdr.undp.org/docs/publications/occasionalpapers/oc24aa. Pebruari, 6, 2006.
- Lewis, Arthur W., 1954, *Economic Development with Unlimited Supplies Labour*, Manchester : Manchester School Press.
- Li, Hongyi and Liang, Huang, 2010, Health, Education, and Economic Growth in East Asia, *Journal of Chinese and Foreign Trade Studies*, vol. 3 No. 2, 2010.
- Lokshin, Michael & Yemtsov, Ruslan, 2003. "Evaluating the impact of infrastructure rehabilitation projects on household welfare in rural Georgia," Policy Research Working Paper Series 3155, The World Bank
- Majdi, Mekdem, 2012, Study of the Relation Between Health and Economic Growth, *Interdisciplinary Journal of Contemporary Research in Business*, May 2012 vol. 4 No. 1.
- Mankiw, Romer dan Weil 1992, "A Contribution to the Empirics of Economic Growth" *The Quarterly Journal of Economics*, Vol. 107, No. 2, pp. 407-437, JSTOR.
- Mankiw, N.Gregory. 2000. *Teori Makro Ekonomi Ed.4*, Jakarta: Penerbit Airlangga.
- Mankiw, N.Gregory. 2003. *Macroeconomics. Fifth Editions*. New York. Worth Publishers. 41 Madison Avenue.
- Mardiasmo, 2004. *Otonomi dan Manajemen Keuangan Daerah*, Penerbit, Andi Offset, Yogyakarta.
- Martinez-Vazquez, J., and R. McNab, 1997. Fiscal Decentralization, Economic Growth, and Demographic Governance. International Studies Program, Working Paper 97-7, Atlanta, Georgia State University.
- McGee Rosemary and Brock Karen 2001, "From poverty Assessment To Policy Change: Processes, Actors And Data" Working Paper 133, Institutes Of Development Studies, Brighton Sussex England..
- Meier, G. M. dan J. E. Rauch. 2000. *Leading Issues in Economic Development (seventh edition)*. New York-Oxford: Oxford University Press
- Miles, D., G. Myles, dan I. Preston, 2003. *The Economics of Public Spending*. New York, Oxford University Press.
- Mills dan Pernia. 1993. Korelasi Pertumbuhan Ekonomi dan Tingkat Kemiskinan di Indonesia. <https://yusniarisanti0795.wordpress.com>
- Mundle, S 1998, "Financing Human Development: Some Lessons from Advanced Asian Countries", *World Development* 26 (4):659-672
- Musgrave, Richard S., and Peggy B. Musgrave. 1989. *Public Finance in Theory and Practice*. New York: McGraw-Hill Book Company
- Myrdal, G. 1957. *Economic Theory and Underdeveloped Region*, Chapter 3: The Drift Towards Economic Inequalities In A Country
- Oluwatobi, Stephen, O. And Ogunrinola, I. Oluranti, 2011, Government Expenditure on Human Capital Development: Implications for Economic Growth in Nigeria; *Journal of Sustainable Development*, Departement of Economics and Development Studies, Covenant University Nigeria, 2011.

- Onuorah, A.C., and Akujuobi, L.E., 2012. Empirical Analysis of Public Expenditure and Economic Growth in Nigeria. *Arabian Journal of Business and Management Review*. Vol. 1. No. 11. 2012.
- Owen, Robert G. 1987. *Organization Behaviour in Education*. New Jersey: Englewood Clift)
- Parikesit, D., H. Purwoto and O. Z. Tamin. 2000. Economic Impact and Indirect Benefit of the Road Sector Budget. WP04: Technical Report. A Report prepared for SEPM Project Team, Jakarta
- Perkons, D.H., S. Radelet, D.R. Snodgrass, M. Gillis, 2001. *Economics of Development*, Fifth Edition, New York, WW. Norton & Company.
- Pigou, A.C M.A., 1960. *The Economic of Welfare*. Fourth Edition,. London; Mac Millan & CO LTD.
- Poli,WIM, 2010. *Tonggak-tonggak Sejarah Pemikiran Ekonomi*, Brilliant Internasional Cetakan Pertama.
- Pradhan, Rudra Prakash, 2010, Transport Infrastructure, Energy Consumption and Economic Growth Triangle in India: Contigration and Causality Analysis, *Journal of Sustainable Development*, Vinod Gupta School of Management, India Institute of Technology Kharagpur, India, 2010.
- Premchand, Arigapudi. 1999. Public Financial accountability, governance, corruption, and public financial management, by salvatore schiavencampo, ADB. November, Manila: 145-192
- Presber, Julian, J.H., 2011. The Chines Financial System and Its Impact On Economic Growth In China. *The ISM Journal of International Business*, 2011.
- Qiao, Martinez-Vazquez, dan Xu 2008. Expenditure Assignments in China
- Qureshi, Muhammad Azeem, 2009. Human development, public expenditure and economic growth: a system dynamics approach. System Dynamics Group, School of Social Sciences, University of Bergen, Bergen, Norway and Institute of Management Sciences, Bahauddin Zakariya University, Multan, Pakistan
- Ramirez, A., Raniz, G., and Stewart, F. 1998. Economic Growth and Human Capital, *World Development* 28 (2): 197-219.
- Raniz, G., and Stewart, F. Strategy for Success in Human Development.
<http://hdr.undp.or./docs/training/oxford/reading/Ranis%20and%20stewart.pdf> 15 Pebruari 2005.
- Ranis G and Stewart 2002, "Economic growth and human development in Latin America" *Cepal Review* 78
- Ravallion, Martin, 1995. Growth and Poverty: Evidence for Developing Countries in the 1980s, *Economics Letters* 48: 411-417.
- Ravallion, M. and G. Datt., 2000. When Growth is Pro-Poor? Evidence from the Diverse Experience of Indian States, The World Bank, Policy Research Working Paper #2263.
- Richardson, W, Harry, 1978. *Regional and Urban Economics*. Penguin Books. Great Britain : The Chausess Press Ltd.
- Rosen, H.S., and T. Gayer, 2008. *Public Finance*, Eighth Edition. Singapore and New York, McGraw-Hill International Edition.
- Safdari, Mehri, and Elahi, 2011. Impact of Human Capital on Economic Growth in Iran. *European Journal of Economics, Finance and Administrative Sciences*. ISSN 1450-2275 Issue 41 (2011). © EuroJournals, Inc. 2011. <http://www.eurojournals.com>
- Sen, A., 1999. *Employment, Tachonology, and Development*, Indian ed. Oxford University Press, New Delhi.
- Sepulveda, Cristian F., 2010, *The Consequences of Fiscal Decentralization on Poverty and Inequality*, George State University.
- Shelly, Gary L., and Wright, David B., 2008. Incremental State Higher Education Expenditures. *International Atlantic Economic Society*, 2008.
- Solow, R.M., 2000. *Growth Theory: An Exposition*. New York, Oxfodr University Press.
- Son HH and Kakwani N 2004, "Economic Growth And Poverty Reduction: Initial Conditions Matter", Working Paper No 2 International Poverty Centre, UNDP,
- Soubbotina, T.P. 2004. *Beyond Economic Growth (An Introduction to Sustaianable Development)*. The World Bank : Washington, D.C
- Sumner, Andy, 2012, *The Evolving Composition of Poverty in Middle-Income Countires: The Case of Indonesia 1991-2007*, IDS Working Paper, Volume 2012 No. 409.
- Tachiwou, Aboudou Maman, 2011. Infrastructure Development and Economic Growth in Togo. *International Journal of Economics and Finance*, Vol. 3. No. 3. 2011.
- Tang, Chor Foon and Lai, Yew Wah The Causal Relationship between ealth and Education Expenditures in Malaysia. *Theoretical and Applied Economics Volume XVIII (2011)*, No. 8(561), pp. 61-74
- Todaro, Michael, P., dan Smith, SC. 2003. *Economic Development*. Eighth Edition. Pearson Education.
- Todaro , Michael, P., 2004. *Pembangunan Ekonomi di Dunia Ketiga*. Penerbit Erlangga Edisi Kedelapan, 2004.
- Tresch, R.W., 2008. *Public Sector Economics*. New York, Palgrave Macmillan.
- Tri, Maryani, 2011. *Analisis Indeks Pembangunan Manusia di Provinsi Jawa Tengah*, Tesis, UPN Veteran, Yogyakarta.
- UNDP, 2006. *Beyond Scarcity: Power, Poverty and The Global Water Crisis*. Human Development Report 2006. New York, UNDP.

- Van Den Berg, H. 2005. *Economic Growth and Development: An Analysis of Our Economic Achievements and Our Most Exciting Challenges*. Singapore and New York, McGraw-Hill International Edition, Economic Series.
- Vanegas, Manuel 2014. *The triangle of poverty, economic growth, and inequality in Central America: does tourism matter?* Department of Applied Economics, University of Minnesota, Falcon Heights, Minnesota, USA
- Wodon, Quentin T., 1999. *Growth, Poverty, and Inequality: A Regional Panel for Bangladesh*, The World Bank, Policy Research Working Paper #2070, March.
- World Bank. 1994. *World Development Report: Infrastructure for Development*. Oxford University Press, New York.
- World Bank, 2007c. *Analisis Pengeluaran Publik Papua: Sebuah Tinjauan Umum Keuangan Daerah dan Pelayanan Publik Pada Wilayah Tertinggal DI Indonesia*. Pemda Papua, Support Office For Eastern Indonesia (SofEI), The World Bank.
- Yao, Guevera Assamoi, 2007, *Fiscal Decentralization and Poverty Reduction Outcomes: Theory and Evidence*, George State University.
- Xie, D., Zou, H. and Davoodi, H. 1999. "Fiscal decentralization and economic growth in the United States", *Journal of Urban Economics*, 45(2), , 228–39.
- Zaman, Miethy, 2012. *Human Capital and Economic Growth: An empirical investigation using panel data*, (MSc Student, Economics, University of Nottingham, United Kingdom). *IOSR Journal Of Humanities And Social Science (JHSS)*. ISSN: 2279-0837, ISBN: 2279-0845. Volume 4, Issue 6 (Nov. - Dec. 2012), PP 43-56 www.Iosrjournals.Org.



The Moderating Role of the Legal Environment on the Relationship between TMT Characteristics and Organizational Performance in a Regulatory Setting in Kenya

Joseph O. Oketch¹, James M. Kilika², Godfrey M. Kinyua³

¹ Department of Business Administration, School of Business, Kenyatta University, Nairobi, Kenya. Email: jseph.oketch@gmail.com

² Department of Business Administration, School of Business, Kenyatta University, Nairobi, Kenya. Email: jmkilika@gmail.com

³ Department of Business Administration, School of Business, Kenyatta University, Nairobi, Kenya. Email: jefkinyua@gmail.com

Abstract

The legal environments of regulatory agencies are key predictors of their organizational performance as they influence how the regulatory agencies are created, their mandates, sources of funding and reporting frameworks. Reporting frameworks include the nature of the relationships between the regulatory agencies and the policy makers, political actors, the legislature, the executive, judicial processes, regulated entities and the public. The specific objective of the study was to establish the moderating effect of the legal environment on the relationship between top management team characteristics and organizational performance of the independent regulatory agencies in Kenya. To achieve this objective, the study adopted descriptive cross-sectional research design. The target population of the study was all the twenty-three state regulatory agencies currently existing in Kenya. Due to the uniqueness of each independent regulatory agency and the distinct roles played by each top management team member in their organization, the study adopted a census survey of all the top management team members in all the twenty three state regulatory agencies in order to capture the required information. Primary data was gathered using structured questionnaire administered through drop and pick later method. Descriptive statistics was then used to summarize the survey data into percentages, frequencies, means and standard deviations. Whisman and McClelland model was used to test for the moderation. The findings of the study showed that legal environment has significant moderating effect on the relationship between top management team characteristics and performance of the independent regulatory agencies in Kenya. The study recommends that the independent regulatory agencies should have stable funding mechanism so as not to rely on the parent ministries or exchequer support for them to be financially independent in executing their mandates. Lastly the study recommends for judicial system to recognize and support the work of the independent regulatory agencies in enforcement of the laws and regulations for their sectors or sub-sectors.

Keywords: Top Management Team Characteristics, Legal Environment, Independent Regulatory Agencies, Organizational Performance

1.0. Introduction

The external environment influences organizations as they make and execute strategic decisions aimed at propelling them to superior organizational performance regardless of the industry of their businesses (Hitt, Ireland, Sirmon & Trahms, 2011). According to Mkalama (2014), organizations today face external environments that are very dynamic and all the times filled with uncertainty. Several previous strategic management scholars have thus argued that to competently deal with the uncertainties presented by their external environments and to remain strategically focused so as to exhibit exemplary performance, organizations must always scan their external environments and fully understand the situations presented. Organizations must therefore build capabilities and core competences in order to counter the negative effects presented by their external environment while taking advantage of all the opportunities available (Njoroge, Ongeti, Kinuu & Kasomi, 2016). For the independent regulatory agencies, the legal environment gives them their mandates, defines their institutional structures and funding sources, and outlines their relationships to the sectors they regulate. The legal environment, therefore, sets the foundations for all their activities and beacons for evaluating their performance. It has been observed by previous strategic management scholars that the legal environments in all countries are becoming very volatile as governments try to enact legislations to match the ever changing expectations of their citizens and business landscapes due to globalization (Kikoyo, 2014).

The laws passed by governments and international laws adapted by a country for business operations form the legal environment of organizations in that country. The legal environment thus includes all the laws, regulations and government policies or directives that provide the relational systems between political power and any business. All countries or governments desire to regulate business activities within their borders. The legal environment therefore decides the limits for business operations. According to governments, the legal environment is meant to ensure a climate of political and legal stability, which should encourage desired businesses while discouraging the un-desired businesses and help in avoiding risks to either the citizens or the business entities (Voiculet, Belu, Parpandel & Rizea, 2010). The legal environments of regulatory agencies are mostly influenced by how the regulatory agencies are created, their mandates, sources of funding and reporting frameworks. Reporting frameworks include the nature of the relationships between the regulatory agencies' and the policy makers, political actors, the legislature, the executive, judicial processes, regulated entities and the public (OECD, 2013). Kikoyo (2014) conceptualized legal environment of regulatory agencies from three main dimensions namely; government policies for the sectors being regulated, laws in the country that form the regulatory agencies and the regulations that operationalizes the laws, and lastly the judicial systems in the country that deal with enforcement of laws. According to Christensen (2004), the greatest legal environmental challenge faced by regulatory agencies result from weak foundations of regulatory reforms and the intricate trade-off between political control and independence of the regulatory agencies.

Top management team characteristics refer to unique personal traits ascribed to members of the TMT that are either inborn or acquired, noticeable or perceptive. They are predictors of the worth of the TMT members in carrying out their tasks and managing their organizations (Mkalama, 2014). Previous scholars have grouped top management team characteristics into three categories namely, demographic characteristics, cognitive characteristics and psychological characteristics (Kasomi, 2015). Demographic characteristics are the observable or readily detectable features such as age, gender, education level, functional backgrounds and tenure. Psychological characteristics refer to subjective attributes such as personality traits and personal attitudes and beliefs such as self-esteem, self-efficacy, locus of control, emotional stability, task specific self-efficacy, optimism and resilience. Cognitive characteristics are associated with the ability of the TMT member to learn, remember, problem-solve and pay attention as they carry out their tasks (Kinuu, 2014).

Superior organizational performance is the most sought after outcome by all organizations be they public, private, national or multi-national, profit or non-profit organizations. However the definition of organizational performance remains to be a prickly subject among strategic management circles with various scholars and practitioners defining organizational performance differently (Kasomi, 2015). Javier (2002) while contributing to the subject, defined organizational performance in terms of economic, efficient and effective utilization of organizational resources in its activities. This is closer to what Daft (2000), suggested by postulating organizational

performance to be the capacity of the organization to realize its objectives and attain its goals through utilizing its assets in a proficient and appropriate way. Ricardo and Wade (2001), in their argument viewed organizational performance as the capability of an organization to maximize on its strengths while overcoming its weakness and to neutralize its threats while taking advantage of opportunities in order to achieve its objectives and goals.

Independent regulatory agencies in Kenya are a special category of state corporations with oversight role over their sectors or sub-sectors. They license operators, set prices where necessary, protect consumers, enforce compliance to licence conditions and market rules, enforce standards as well as codes of practice for the industry. They are meant to spur growth and improve services to consumers or end-users of the services in their particular industries. Currently there are twenty three (23) independent regulatory agencies in Kenya although there are plans to merge some of them so as to make them more efficient and effective. The management of the independent regulatory agencies in Kenya is bestowed on their board of directors and top management teams. Selection and identification of the top management teams with the requisite characteristics for each regulatory agency has been identified as an aspect that affects their performance (PTRP, 2013). Previous studies on performance of state corporations in Kenya have identified that some top management teams are deficient of appropriate talents that can enable implementation of suitable strategic management practices that could positively influence the performance of their organizations. Some of the top management teams have also been associated with failure of their organizations to align themselves to their ever changing and demanding business environments (Mkalama, 2014). The variation in the performance of the independent regulatory agencies have also been attributed to several other factors like; utilization of resources, poor identification of stakeholders and their needs, lack of sufficient resources, in appropriate organization structures and weak corporate governance structures (Ongeti, 2014).

2.0. Statement of the Problem

The Legal environment of state regulatory agencies are mostly influenced by how the regulatory agencies are created, their mandates, funding sources and institutional frameworks. The legal environment also defines the kind of association between the regulatory agencies and the various arms of government like the policy makers, the legislature, the executive and the judiciary as well as the regulated entities and the general public (OECD, 2013). Lack of clarity of roles, mandates and resources to the independent regulatory agencies are some of the factors that negatively affect their organizational performance (Stern, 2010). It has been argued that the institutional frameworks of the independent regulatory agencies have unclear or duplicate reporting lines that lead to ambiguity on the roles that the agencies ought to play in their various sectors or sub-sectors. On paper, the state regulatory agencies are meant to be independent and to have oversight roles over the regulated entities in their sectors or sub-sectors while the government ministries deal with policy. This has not been the case as the government still has strong control over the independent regulatory agencies as well as some of the regulated entities (GoK, 2013). This study therefore opted to investigate the moderating role of the legal environment on the relationship between TMT characteristics and performance in a regulatory setting in Kenya.

3.0. Literature Review

3.1. Theoretical Review

The advocates of open systems theory have argued that firms are influenced by what goes on in their external environments as they conduct their businesses. This is premised on the postulation of Ansoff & McDonell (1990) that organizations are environment serving and dependent. It is therefore necessary that organizations adapt or create a strategic fit with their environment if they are to sustain superior organizational performance (Njoroge, 2015). External environment has been considered by previous strategic management scholars to consist of interlinked sets of situations that play crucial roles in shaping the prospects, risks and limitations that organizations face and that impinge on their activities hence affecting their organizational performance. The external environment consists of situations originating beyond the organization's operating sphere and can be broadly categorized into legal, economic, political, social and technological forces. These factors are commonly designated as macro- environment (Pearce and Robinson, 2007). The other elements of the external environment are the situations influencing immediate operating sphere of the organization also denoted as micro-environment or industry forces. The micro-environment comprise of the labour markets, customers, suppliers, creditors, and trade

unions. They either encourage or limit the accomplishment of set organizational goals and impinge on the internal operations of the organization thus affecting its objectives and strategies (Gupta, 2009).

The legal environment influences organizations as they make and execute strategic decisions aimed at propelling them to superior organizational performance regardless of the industry in which the organizations operate in (Hitt, Ireland, Sirmon & Trahms, 2011). According to Mkalama (2014), organizations today face external environments that are very dynamic and all the times filled with uncertainty. Organizations must always therefore fully comprehend the different situations presented by their external environment to competently deal with the uncertainties presented in order to remain strategically focused and to thrive. Organizations must hence build capabilities and core competences to assist them in countering the negative effects presented by their external environments while taking advantage of all the opportunities available (Njoroge, Ongeti, Kinuu & Kasomi, 2016). The study of the moderating role of the legal environment on the relationship between TMT characteristics and performance in a regulatory setting in Kenya was therefore anchored on the open systems theory.

3.2. Conceptual and Empirical Review

Previous strategic management researchers have argued that it is crucial for organizations to synchronize themselves to the changing environmental conditions in order to thrive. They have asserted that organizations must continuously scan their environments to identify opportunities to exploit and threats to mitigate against so that they gain or maintain sustained competitive advantage. Thus the structure and characteristics of the environments where organizations operate have been identified to be vital for their organizational performance (Kirkbesoglu, 2012). The legal environment has been argued to provide a model for organizational life as it constructs important roles for organizational actors and impacts positively or negatively to their operations by establishing norms that penetrates into the organizational life. Thus, organizations must conform to their legal environment for them to remain relevant and to be allowed to remain in business. The structures and processes of organizations are therefore shaped in such a way as to comply with the dictates of their legal environments (Kikoyo, 2014). Although the component of environment has been scrutinized ostentatiously in several studies on different spheres, studies on the relationships between organizations and their legal environments remain to be limited.

According to Wheelen and Hunger (2009), strategic management process in organizations can be divided into four inter linked phases namely, environmental scanning, strategy formulation, strategy execution, and strategy evaluation and control. Environmental scanning is meant to assist the organizations identify openings and risks that are likely to affect the organizations' activities negatively or positively in the short term and long term. The external environment of organizations has been conceptualized by previous strategic management researchers to include political, legal, economic, social and technological factors that impinge on operations of the organizations. These scholars have viewed external environment as a provider of resources and information that are vital for the survival of organizations (Marcus, 2011).

According to Nogal-Meger (2018), one aspect of the legal environment is the regulatory enforcement framework. The study operationalized regulatory enforcement framework in terms of how objectively and meritoriously regulations are instigated and administered. The researchers argued that regulations set legal and organizational structures within the particular industries being regulated by governments. They therefore asserted that the regulatory enforcement framework aspect of the legal environment sets how government regulations are effectively applied and their influence on the regulated entities and the economy in general.

The study further highlighted that regulatory proceedings must be promptly conducted to ensure there are no arbitrary delays and that due process must be followed in the regulatory proceedings. According to the researchers, the second aspect of the legal environment is the concept of the rule of law that protects against manifestations of arbitrariness and sets standards of accountability for the entities involve in applying the regulations. The focus of the current study therefore was to investigate the influence of the legal environment on organizational performance of state regulatory agencies in Kenya. This is because the legal environment of the independent regulatory agencies gives them their mandates, defines their institutional structures as well as their relationships with the sectors or sub-sectors they regulate.

The greatest legal environmental challenge faced by regulatory agencies result from weak foundations of regulatory reforms and the intricate trade-off between political control and independence of the regulatory agencies. The current study therefore conceptualized the legal environment in terms of sector policies, Acts of parliaments or presidential directives and sector or sub-sector regulations (Christensen, 2004). The study categorized TMT characteristics into three sub-variables namely, TMT demographics, TMT psychological and TMT cognitive characteristics. The study hence operationalized TMT demographic characteristics in terms of age, education, functional background, tenure (Carpenter, 2002) and gender representation (Dezso & Ross, 2012). Likewise the study operationalized TMT psychological characteristics in terms of self-esteem, general self-efficacy, optimism, emotional stability, task specific self-efficacy, resilience and locus of control (Kinuu, 2014). TMT cognitive characteristics was operationalized terms of problem solving, attention, memory and learning (Bouquet, Morrison & Birkinshaw, 2003). Lastly the study operationalized organizational performance in terms of effectiveness, efficiency, relevance and financial viability (Muraga (2015).

The study thus conceptualized a relationship as revealed by reviewed literature on the effect of legal environment on the relationship between TMT characteristics and organizational performance. In the conceptual model below, TMT characteristics is the independent variable while organizational performance of the independent regulatory agencies is the dependent variable, while the legal environment is the moderating variable. These relationships are captured in the schematic model in Figure 2.

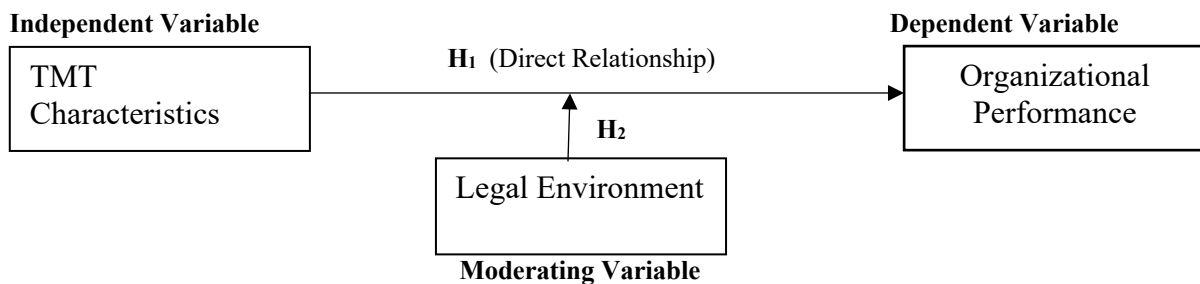

Figure 2: Conceptual Framework

Based on the logic presented in the conceptual framework, the authors proposed that the legal environment would moderate the effect of TMT characteristics on organizational performance of the independent regulatory agencies in Kenya. Specifically, the study proposed that;

Hypothesis H₁: TMT characteristics has a significant effect on organizational performance.

Hypothesis H₂: The Legal environment has a significant moderation effect on the relationship between Top management team characteristics and organizational performance of the independent regulatory agencies in Kenya.

4.0. Research Methodology

The study adopted positivist research philosophy since it delved to look at what causes the particular relationships and what the effects of these relationship are. Positivism philosophy favours quantitative methods where considerable amount of data is gathered for analysis (Muchemi, 2013). Positivist philosophy was also considered appropriate for the study as the researchers were independent of the phenomena being investigated and the properties of the occurrences under study were objectively measured (Mugenda & Mugenda, 2003). The study used a cross-sectional survey design because cross-sectional surveys enable collection of data across a large number of organizations at one point in time for analysis. In a cross-sectional survey research design, the desired data for each variable in the study can be collected from the entire population or a section of it to help test the research hypotheses (Njoroge, 2015). Other researchers like Mkalama (2014), Muchemi (2013), Ongeti (2014) and Kasomi (2015) while trying to test hypotheses and draw conclusions in similar studies have also used cross-sectional survey design successfully.

The study context was the independent regulatory agencies in Kenya. According to the presidential task force on parastatal reforms (PTPR) of 2013, Kenya had a total of one hundred and seventy-eight (178) state corporations spread across eighteen (18) government ministries as at 30th June 2013, out of which twenty three (23) were the independent regulatory agencies (GoK, 2013). The unit of analysis for this study was the twenty three (23) state regulatory agencies while the unit of observation was two hundred and thirty two (232) TMTs spread across the twenty three (23) independent regulatory agencies in Kenya. The researchers used a census of all the 232 TMTs from all the state regulatory agency as each was considered to have unique information relating to how the characteristics of the TMTs affected performance of their independent regulatory agencies. Primary data was collected using a structured questionnaire comprising of closed ended questions. The questionnaire was developed in line with the objectives and hypotheses of the study and guided by the literature review as well as theories underpinning the various study variables. Data on the variables were measured using a five point Likert scale ranging from "not at all" (1) to (5) "to a very large extent." The positive responses were validated, edited for completeness and consistency upon receipt in order to prepare them for statistical analysis. Descriptive and inferential statistics were then used to analyze the prepared data. Diagnostic tests of normality, multi-collinearity and homoscedasticity were carried out on the study data. The results confirmed that there were no violation of the assumptions of linear regression analysis that could result in biased estimates, over or under confident estimates of the precision of regression coefficients and untrustworthy confidence levels and significance tests (Chatterjee & Hadi, 2012). The test for the moderation effect adopted the 2 steps approach postulated by Whisman and McClelland (2005).

Step 1: The influence of TMT characteristics on Organizational Performance

The first model in the moderation was deployed to investigate the combined effect of the TMT characteristics on organizational performance.

$$\text{Organizational Performance} = \beta_{10} + \beta_{11} \text{ TMT Characteristics} + \varepsilon \dots\dots\dots 1$$

Step 2: Effect of TMT characteristics on Strategy Execution

The second step involved regression analysis of organizational performance on TMT characteristics, legal environment, and the interaction term between TMT characteristics and legal environment.

$$\text{Organizational Performance} = \beta_{70} + \beta_{71} \text{ TMT Characteristics} + \beta_{72} \text{ Legal Environment} + \beta_{73} \text{ TMT Characteristics} * \text{ Legal Environment} + \varepsilon \dots\dots\dots 2$$

Where; β_{ii} = Beta coefficient
 ε = Error term

The inferential statistics included regression model summary, ANOVA and regression coefficients of the independent variables. The hypotheses were tested at 0.05 level ($\alpha=0.05$), hence where the calculated p value was less than 0.05, the model was established to be statistically significant and the study failed to reject the null hypothesis but where the calculated p value was greater than 0.05, the model was established to be statistically insignificant and the study rejected the null hypothesis.

5.0. Research Findings

5.1. Respondents Characteristics

The researchers distributed 232 questionnaires, out of which 166 were responded to positively. This represented an overall response rate of 71.6%. The respondents were from 19 state regulatory agencies out of the targeted 23, representing 82.6% involvement of the state regulatory agencies in Kenya. Similar previous studies conducted in the Kenyan context by Muchemi (2013) and Muraga (2015) had comparable response rates of 72.5% and 72.1% respectively. According to Mugenda and Mugenda (2003), 50% response rate is considered adequate, 60% good and above 70% very good. Very good response rates yield results that can be better inferred to a population

(Awino, 2011). Therefore, the study response rate was adjudged to be very good and appropriate. The respondent's characteristics are as shown in table 1.

Table 1: Respondents' Characteristics

Category	Number	Percentage
Designation		
CEO	10	6.0
Director/GM	45	27.1
Head of Department	84	50.6
Deputy Head of Department	1	0.6
Head of Section	24	14.5
Others	2	1.2
Total	166	100
Gender		
Male	115	69.2
Female	51	30.8
Total	116	100
Age		
30 and Below	1	0.6
31 - 35	5	3.0
36 - 40	9	5.4
41 - 45	47	28.3
46 - 50	65	39.2
51 - 55	34	20.5
Above 55	5	3.0
Total	116	100
Education		
Bachelors	19	11.4
Masters	131	79.0
PhD	16	9.6
Total	166	100
Tenure		
0 - 5	82	49.4
6 - 10	66	39.8
11 - 15	14	8.4
16 - 20	1	0.6
Over 20	3	1.8
Total	166	100
Functional Area		
Support	101	60.8
Technical	65	39.2
Total	166	100.0

The statistics in table 1 show that majority of the respondents were heads of departments at 50.6% (84) followed by directors/general managers at 27.1% (45), heads of sections at 14.5% (24), CEOs at 6.0% (10), others at 1.2% (2) and lastly deputy heads of departments at 0.6% (1). The findings in table 1 therefore demonstrated that all of the respondents were CEOs and those directly reporting to them as the top management team was conceptualized in the study. The summarized statistics presented in table 1 further show that the respondents were not fairly distributed across gender. There were more male respondents at 69.2% (115) than female respondents at 30.8% (51). For age distribution of the respondents, majority were in the age bracket 46-50 at 39.2% (65) followed by 41-45 at 28.3% (47), 51-55 at 20.5% (34), 36-40 at 5.4% (9), a tie of 31-35 and above 55 at 3% (5), and lastly 30

and below at 0.6% (1). Concerning the highest level of education, majority of the respondents had master's degrees at 79% (131), followed by bachelor's degrees at 11.4% (19) and Ph.D. at 9.6% (16). On the functional area of the respondents, support functions which had many departments had majority of the respondents at 60.8% (101) while technical departments which had few departments had 39.2% (65).

5.2. The Variable Characteristics

The descriptive statistics of the study variables comprising of the number of items used to measure the variables, Cronbach's alpha (α), aggregate mean score and aggregate standard deviation are as shown in table 2.

Table 2: Descriptive Characteristics

Variable	No. of Items	(α) Score	Aggregate Mean	Aggregate Std Dev.
TMT Demographic Characteristics	16	0.859	3.684	0.867
TMT Cognitive Characteristics	9	0.944	4.175	0.745
TMT Psychological Characteristics	24	0.867	4.570	0.430
Legal Environment	12	0.831	4.090	0.868
Organizational Performance	28	0.949	4.190	0.787

The descriptive statistics presented in table 2 show that the Cronbach's alpha was 0.859 for demographic characteristics, 0.867 for psychological characteristics, 0.944 for cognitive characteristics, 0.831 for legal environment and 0.949 for organizational performance that were all greater than the threshold Cronbach's alpha value of 0.7 adopted by the study, thus the research instrument passed internally consistency test. The overall aggregate mean score for demographic characteristics was 3.684 that indicates that the respondents on average agreed to a moderate extent that the attributes of the demographic characteristics applied to their independent regulatory agencies while the standard deviation of 0.867 indicates that there were considerable variations within and among the state regulatory agencies. The overall aggregate mean score for psychological characteristics was 4.175 with a standard deviation of 0.745 that indicates that on average the respondents agreed to a large extent with the attributes under psychological characteristics as pertains to their job performance in their current roles while the standard deviation indicates that the responses for psychological characteristics were more clustered around the mean scores than were the scores for demographic characteristics. The overall aggregate mean score for cognitive characteristics was 4.57 with a standard deviation of 0.430 that indicates that on average the respondents agreed to a large extent with the attributes under cognitive characteristics as pertains to their job performance in their current roles while the standard deviation indicates that the responses for cognitive characteristics were more clustered around the mean scores than were the scores for both demographic characteristics and psychological characteristics. The overall aggregate mean score for the legal environment was 4.090 that indicates that the respondents on average agreed to a large extent that the attributes of the legal environment applied to their independent regulatory agencies while the standard deviation of 0.868 indicates that there were considerable variations within and among the state regulatory agencies. Lastly, the overall aggregate mean score for organizational performance was 4.190 that indicates that the respondents agreed to a large extent that the attributes of organizational performance applied to their independent regulatory agencies while the standard deviation of 0.787 indicates that there were considerable variations within and among the independent regulatory agencies.

5.3. Test of Hypotheses

The test of the research hypotheses was conducted was on stages. First, the study tested the direct effect of TMT characteristics on organizational performance of the state regulatory agencies. In order to test the hypotheses, a composite index of the various components of TMT characteristics was computed using the formula proposed by Kilika (2012) based on the harmonic mean.

5.3.1. Test of Hypothesis One

This hypothesis sought to understand whether there is any statistically significant effect of the combined effect of TMT characteristics on the performance of the independent regulatory agencies in Kenya. The regression analysis output is summarized in in table 3.

Table 3: Regression of Organizational Performance on TMT Characteristics

Model Summary						
Model	R	R Square	Adjusted R Square	Std. Error of the Estimate	Durbin-Watson	
1	.556 ^a	.309	.305	.37618	2.049	
ANOVA						
Model		Sum of Squares	df	Mean Square	F	Sig.
1	Regression	10.378	1	10.378	73.335	.000 ^b
	Residual	23.208	164	.142		
	Total	33.586	165			
Coefficients						
Model		Unstandardized Coefficients		Standardized Coefficients	t	Sig.
		B	Std. Error	Beta		
1	(Constant)	1.030	.361		2.853	.005
	Combined TMT Characteristics	.763	.089	.556	8.564	.000

The results indicate that TMT characteristics explain 30.5% of the variation in organizational performance of the independent regulatory agencies in Kenya. The other 69.5% of the variation is attributed to other factors not included in the empirical model. The F statistic of 73.335 with a p-value of 0.000 indicates that the regression model is significant in predicting this relationship. The summarized statistics in table 3 further show that the beta coefficient for the constant (β_0) is 1.030 with a t statistics of 2.853 and a p value of 0.005 while the standardized beta coefficient for the combined TMT characteristics (β_1) is 0.556 with t statistics of 8.564 and p-value of 0.000. Since the p-value is less than the significance level of 0.05, combined TMT characteristics was found to be a significant predictor of organizational performance. The β_0 of 1.030 implies that with the combined TMT characteristics held constant, organizational performance will be at 1.030 while β_1 of 0.556 indicates that if all other factors are constant, a unit change in the Top management characteristics would result to 0.556 change in organizational performance. Hypothesis one is therefore supported and the study concluded that TMT characteristics has a significant statistical effect on organizational performance of the independent regulatory agencies in Kenya.

5.3.2. Test of Hypothesis Two

This hypothesis sought to understand whether there is any statistically significant moderating effect of the legal environment on the relationship between TMT characteristics and organizational performance of the independent regulatory agencies in Kenya. To evaluate the moderation effect of legal environment on the relationship between TMT characteristics and organizational performance. Two steps regression analysis was conducted in accordance with the moderation model proposed by Whisman and McClelland (2005). The results from the four steps are summarized in table 4.

Table 4: Summary of Regression Results for the Moderating Effect

Parameter	Step 1	p-Value	Step 2	p-Value	Change	Decision
R ²	0.309	-----	0.533	-----	0.224	Legal environment has moderating effect on the relationship between TMT characteristics and organizational performance.
Adjusted R ²	0.305	-----	0.527	-----	0.222	
F Statistics	73.335	0.000	85.471	0.000	12.1336	
β Constant	1.030	0.005	1.889	0.000	0.859	
β TMT characteristics	β ₆₁ =0.556	0.000	β ₇₁ = 0.505	0.000	-0.051	
β Legal environment	-----	-----	β ₇₂ = 0.446	0.000	-----	
β Interaction Term	-----	-----	β ₇₃ = 0.589	0.000	-----	
<u>Necessary Condition for Moderation</u>						
β ₆₁ = 0.556, P = 0.000 hence Significant						
β ₇₂ = 0.446, P = 0.000 hence Significant						
β ₇₃ = 0.589, P = 0.000 hence Significant						

From the above summary of findings in table 4, the beta coefficient of TMT characteristics reduced from 0.556 in step 1 to 0.505 in step 2 implying a reduction of 0.051 units. The model was fit at $F = 85.471$, $p = 0.000$. For step 1, the adjusted R² was 0.309 while for step 2 the adjusted R² was 0.527, implying an overall increase of adjusted R² by 0.222 units. The results thus implies that the percentage of the dependent variable explained by variables in the regression model increased by 22.2% in step 2. According to McClelland and Whisman (2005), a tested moderator is said to be an explanatory variable if the coefficient changes from significance to non-significance. However, the tested moderator is said to have moderating effect if the interaction term coefficients remains significant. The decision on the hypothesis was made using the criteria recommended by Fairland and MacKinnon (2009) that states that if the regression coefficient of the interaction term is statistically different from zero, there is evidence of significant moderation of the relationship between independent variable and the dependent variable. Since $\beta_3 = 0.589$ at $t = 9.859$ and $p\text{-Value} = 0.000$, it is statistically different from zero and significant. Therefore the study rejected the null hypothesis and concluded that legal environment has significant moderating effect on the relationship between top management team characteristics and performance of independent regulatory agencies in Kenya.

6.0. Discussion of Findings

The conclusion of this study can be explained by the descriptive statistics, results from previous researchers and the open systems theory. From descriptive statistics, the three sub-variables under legal environment of sector policies, Acts of parliament/presidential directives and regulations had aggregate mean scores of 3.92, 4.18 and 4.10 respectively with the overall aggregate mean score for the aspects of the legal environment investigated at 4.09 with a standard deviation of 0.868. This means that the respondents to a large extent agreed with the attributes that were measured under the legal environment. In dealing with the legal environment, the context of the study is key as businesses may be in the same kind of legal environment but get affected differently. Like commercial businesses and state corporations, although operating in the same legal environment, will feel the effects differently, this is also true for independent regulatory agencies.

The findings support the postulates of the open systems theory that external environments affects organizations as they conduct their businesses, or in other words, organizations are environment serving and dependent. Top management teams in organizations are responsible for carrying out the business activities of their organizations in order to achieve desirable performance but in carrying out the activities, TMTs must identify opportunities and threats in their environments. They must thus possess attributes to enable them sense and to take actions necessary either to exploit the opportunities or neutralize the threats. For independent regulatory agencies, the legal environment defines their powers and functions that their TMTs use to achieve their objectives and goals.

The findings of the current study are consistent with the observation made by Mkalama (2014), that laws that create and define the mandates of the state corporations and other laws of the land are considered important to the decisions taken and consequently performance of the state corporations. The findings are also consistent with the observation by Njoroge (2015) that external environment moderated on the relationship between strategy implementation and performance of state corporations in Kenya.

7.0. Contribution of the Study

The findings of the current study thus fill the gap identified in the empirical literature review that in investigating the influence of TMT characteristics on organizational performance, it is important to include other variables that affect the relationship. Because TMTs work within legal and institutional frameworks in pursuit of their organizations' mandates, missions and visions in order to achieve the desired organizational outcomes, legal environment is therefore one such variable that affects the relationship between TMT characteristics and organizational performance. The established moderating relationship therefore adds knowledge to strategic management research and practice.

8.0. Conclusions and Recommendations

From the findings of the study reported, the research makes three conclusions. First, that the respondents on average agreed to large extent that the attributes of legal environment applied to their independent regulatory agencies, Second, that the finding could be explained by the fact that the sector policies or presidential directors and Acts of parliament gives the independent regulatory agencies their mandates, funding mechanisms and their institutional arrangements, while regulations gives the independent regulatory agencies their oversight role over the regulated entities and the sectors. The study likewise makes two recommendations. First, that the independent regulatory agencies should have clear institutional frameworks with clearly defined relationships with the government and their regulated entities and industry. Second, that for judicial system to recognize and support the work of the independent regulatory agencies in enforcement of the laws and regulations for their sectors or sub-sectors.

References

- Ansoff, H. I. & Mc Donnell, E.J. (1990). *Implanting Strategic Management*, 2nd Ed., NY: Prentice Hall.
- Awino, Z.B. (2011). *Strategic Management: An Empirical Investigation of Selected Strategy Variables on Firm Performance: A Study of Supply Chain Management in Large Private Manufacturing Firms in Kenya. Prime Journals, 1(1): 9-18.*
- Christensen, T. (2004). *Regulatory Agencies: The Challenges of Balancing Agency Autonomy and Political Control. Stein Rokkan Centre for Social Studies; Working Paper No. 18.*
- Daft, R.L. (2000). *Organization Theory and Design, (7th Ed.)* South-Western College Publishing, Thomson Learning, U.S.A.
- Government of Kenya, (2013). *Sector Plan for Public Sector Reforms 2013 – 2017*
- Gupta, A. (2009). *Organization external environment. Retrieved from <http://www.practical-management.com>.*
- Hitt, M.A., Ireland, R.D., Sirmon, D. G. & Trahms, C. A. (2011). *Strategic Entrepreneurship: Creating Value for Individuals, Organizations and Society. The academy of management perspectives, 25(2): 57-76.*
- Javier (2002). *A review paper on Organizational Culture and Organizational Performance. International. Journal of Business and Social Science, 1(3): 52-76.*
- Kasomi. F. M., (2015). *Diversity in Top Management Teams, Strategic Choice, Top Manager's Compensation Schemes and Performance of Kenyan State Corporations. (Ph.D. Thesis), University of Nairobi, Department of Business Administration, School of Business, Nairobi.*
- Kikoyo, O. I. (2014). *The Impact of Legal Framework on Regulatory Authorities in Tanzania: A Case Study of the Surface and Marine Transport Regulatory Authority (SUMATRA). (PhD Thesis). The Open University of Tanzania.*
- Kilika, J. M. (2012). *Institutional context, collaboration, human resource development infrastructure and performance of universities in Kenya. (Ph. D Thesis), School of Business, University of Nairobi.*
- Kinuu, D. (2014). *Top Management Team Psychological Characteristics, Institutional Environment, Team Processes and Performance of Companies listed in Nairobi Securities Exchange. (PhD Thesis), University of Nairobi, Department of Business Administration, School of Business, Nairobi.*

- Kirkbesoglu, E. (2012). Strategic Reactions of Organizations to Legal Environment: A Typology for Industries in the Process of Institutionalization. *International Journal of Business, Humanities and Technology*, 2(3).
- Marcus A. A. (2011). *Management Strategy: Achieving Sustained Competitive Advantage*, McGraw-Hill Company, America.
- Mkalama, R. N., (2014): Top Management Team Demographics, Strategic Decisions, Macro-Environment and Performance of Kenyan State Corporations. (*PhD Thesis*), University of Nairobi, Department of Business Administration, School of Business, Nairobi.
- Muchemi, W.A., (2013). Top Management Team Diversity and Performance of Commercial Banks in Kenya. (*PhD Thesis*), University of Nairobi, Department of Business Administration, School of Business, Nairobi.
- Mugenda, O.M. & Mugenda, A.G. (2003). *Research Methods: Quantitative and Qualitative Approaches*. Nairobi: ACTS Press.
- Muraga, D. K. (2015). *Strategic Human Resource Management Practices and Performance of Parastatals in Kenya*. (*Ph. D Thesis*), Kenyatta University
- Njoronge, J. K., (2015). Strategy Implementation, Performance Contracting, External Environment and Performance of Kenyan State Corporations. (*PhD Thesis*), University of Nairobi, Department of Business Administration, School of Business, Nairobi.
- Njoroge, J. K., Ongeti, W. T., Kinuu, D. & Kasomi, F. M. (2016). Does External Environment Influence Organizational Performance? The Case of Kenyan State Corporations. *Management and Organization Studies* 3(3). Retrieved from <http://mos.scieducpress.com>.
- Nogal-Meger, P. (2018). The Quality of Business Legal Environment and Its Relation with Business Freedom. *International Journal of Contemporary Management*, 17(2): 111–136. doi:10.4467/24498939IJCM.18.021.8545.
- OECD. (2013). *Principles for the Governance of Regulators*. OECD Publishing, Paris. Retrieved from <http://Regulators.comment@oecd.org>.
- Ongeti, W. J., (2014). Organizational Resources, Corporate Governance Structures and Performance of Kenyan State Corporations. (*PhD Thesis*), University of Nairobi, Department of Business Administration, School of Business, Nairobi.
- PTPR, (2013). *Report of the Presidential Taskforce on Parastatal Reforms*. Retrieved at www.apsea.or.ke/.../76-report-of-presidential-taskforce-on-parastatal-reforms.
- Ricardo, R. and Wade, D. (2001). *Corporate Performance Management: How to Build a Better Organization through Measurement driven Strategies alignment*. Butterworth, Heinemann.
- Stern, J. (2010). The Evaluation of Regulatory Agencies. *Centre for Competition and Regulatory Policy (CCRP)*, City University London. Working Paper No 16.
- Voiculet, A., Belu, N., Parpandel, D. E. & Rizea, I.C. (2010). *The Impact of External Environment on Organizational Development Strategy*. Munich Personal RePEc Archive.
- Wheelen, L. T. & Hunger, J. D. (2009). *Strategic Management and Business Policy Concepts and Cases* Eleventh Edition, Prentice-Hall International, USA.
- Whisman, M. A. & McClelland, G. H. (2005). Designing, Testing, and Interpreting Interactions and Moderator Effects in Family Research. *Journal of Family Psychology* 19(1): 111-120.



Prioritization of Storm Water Drain Construction for an Urban Area in the Chittagong Hill Tracts Region of Bangladesh

Md. Mohirul Islam Mohir¹, Shaolin Shawon²

¹Master of Science in Water Resources Development, BUET, Dhaka, Bangladesh.

E-mail: mohirbuet@gmail.com

²Master of Science Research Student, Department of Physics, BUET, Dhaka, Bangladesh.

E-mail: mss.buet@gmail.com

Abstract

Developing the urban drainage system is now a common issue in most developing countries like Bangladesh. Due to rapid urbanization, drainage related problems are identified as high priority by Municipal residents. Therefore, Municipal Drainage System needs to be developed in such a way that it functions in the long term resulting optimization of the used resources. Storm water flood hazard due to inadequate drain is a major concern in the Municipalities in the Chittagong Hill Tracts (CHT) Regions of Bangladesh. To address the issue, drainage master plans have been prepared for the three Municipalities in the CHT under the Urban Governance and Infrastructure Improvement Project (UGIIP) of Local Government Engineering Department (LGED) funded by Asian Development Bank (ADB). Under this master plan, 78 independent drains are proposed that would be implemented over a period of 10 years. The problem of the master plan implementation is that the available fund for drain construction in each year is a fraction of the total requirement. Considering the situation, the aim of the study is to develop a priority ranking schedule for drain construction. Development of the Multi-Criteria framework for prioritization of storm drain works is the methodology for this research. The outcome of the research is the year-wise implementation schedule of drain construction over the planning period based on available funds for a particular year.

Keywords: Multi-Criteria Analysis, Drain Deficiency, Social Vulnerability, Priority Ranking

1. Introduction

Stormwater flood hazard is a growing concern in urban areas of the Chittagong Hill Tracts (CHT) of Bangladesh. The flood damage is increasing with the change in land use due to the expansion of urban areas. Because of hill topography, flooding occurs in a very short time, and the hazard is quite severe due to flash floods. The existing drains are inadequate to drain the storm runoff. With the financial assistance of ADB, drainage master plans have been prepared for three Municipalities in the CHT under the UGIIP project LGED. One of those is the Drainage Master Plan for Bandarban Municipality (LGED, 2006a). The storm runoff of Bandarban Municipality is discharged to the Sangu river that flows through the town (Figure 1). There is 26.9 km of storm drains in the Municipality Area. A total of 17.8 km of new drains has been proposed in the Master Plan (LGED, 2006a).

Geographically, Bandarban Municipality is a high land area and the town experiences flash floods of different extent almost every year. The magnitude of flood hazard depends on multiple factors such as hydrological, topographical, land use, socio-economic and environmental characteristics of the catchment. Therefore, the Multi-Criteria approach is essential for decision making regarding prioritization of storm drain works. Multi-criteria decision making in water management planning has been emphasized in the National Water Policy (Ministry of Water Resources, 1999). Development of the Multi-Criteria framework for prioritization of storm drain works is the ultimate goal under this study.

2. Materials and Methods

A questionnaire survey has been carried out to assess public response to stormwater flood hazards. The survey has covered 190 households which were obtained on the basis of statistical sampling formula. The distribution of 190 households among 9 Wards is in the proportion to Ward population. The purpose of the survey is to assess the flood situation and its consequences. The respondents identified the location of the flood-affected area, causes of the stormwater flood and public life disruption due to storm waterflood.

Area-elevation relationship has been developed based on the contour map of the study area. The volume-elevation relationship has been derived from the area-elevation relation. A rainfall depth of 123 mm has been used to estimate runoff volume. Based on runoff volume, the flooded area has been identified using volume-elevation and area-elevation relationships. Besides flooding, runoff ways along hill slope areas make disruption to the public and private properties. The runoff ways along hill slope areas have been identified based on the contour map.

A total of 78 independent drains with a length of 17.8 km have been proposed in the Master Plan for Bandarban Municipality. Five criteria have been selected to represent storm flood hazards that would serve as the basis for prioritization of drain construction. These criteria are drain deficiency, flood magnitude, population suffering, damage characteristics, and social vulnerability. The magnitude of five criteria has been calculated for every drain. The standardized value of each criterion is added for a drain to get a total score for the drain with the help of the Linear Additive Model. The scores of 78 drains are ranked in order of decreasing magnitude, and the rank represents priority order. The series of 78 ranks is to be divided into 10 segments to set the year-wise implementation schedule of 78 drains over 10 years. The segments are to be such that the total drains in a segment can be implemented using the budget for that year.

3. Objectives of the Study

The objectives of the study are as follows :

- i) to predict inundation area and consequent damage due to stormwater flooding in the selected urban area in the CHT, and
- ii) to develop indicators for multi-criteria assessment of storm flood hazard for the prioritization of storm drain construction over the planning period in the study area.

4. Chittagong Hill Tracts

Chittagong Hill Tracts (CHT) is the main hill area in Bangladesh and it is covered by tertiary hills. It is located in the southeast part of the country (Figure 1), comprised of Rangamati, Khagrachari and Bandarban hill districts and consists of 25 upazilas of Bangladesh. The population of CHT is 13,42,740 (BBS, 2001). It has an area of 13,180 sq.km, making up approximately 10% of the total area of Bangladesh. Although the population density in this region is as low as 102 persons/sq.km, the ratio of cultivable land per person in CHT region is only 1.04 hectare as most part of the region is covered with numerous hills, ravines, cliffs and dense vegetation (LGED, 2006b). The soils are characterized by low fertility. Tasing-Dong, the highest peak of Bangladesh is located in the Bandarban district.

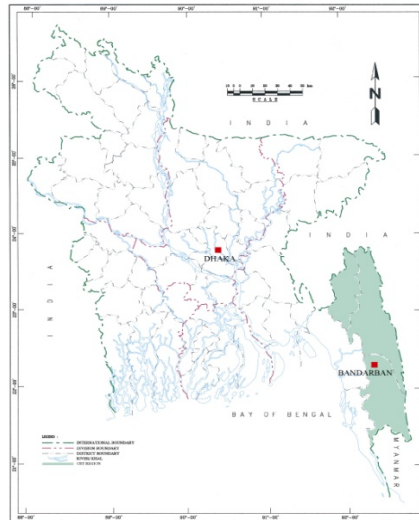

Figure 1 : Chittagong Hill Tracts Regions of Bangladesh

The tribal people who differ culturally from the majority population of Bangladesh are predominantly Buddhists, with small numbers of Hindus. They differ linguistically and in their social organization, marriage customs, birth and death rites, food, agriculture techniques and other social and cultural customs from the people of the rest of the country. According to numbers, the Chakma remains the dominant followed by Marma, Tripura, Tanchangya, Mro, Bawm, Khyang, Pankhu, Khumi, Lushai, Chak and others.

5. Study Area

Bandarban, Khagrachari, and Rangamati were originally a sub-division of Chittagong Hill Tracts District. Bandarban sub-division emerged as a district on the 4th April 1981 and Bandarban Municipality was established in May 1984. Drainage master plans have been prepared for Bandarban, Rangamati and Khagrachari Municipalities in the CHT under the Urban Governance and Infrastructure Improvement Project (UGIIP) of Local Government Engineering Department (LGED). Considering the availability of secondary data and maps, Bandarban Municipality has been selected as the study area.

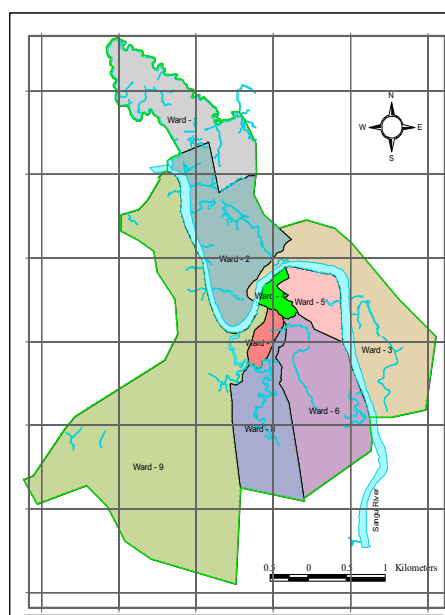

Figure 2 : Bandarban Municipality of Bangladesh

6. Existing Storm Drains

To drain the storm runoff from urban catchments, some drains have been constructed. There is 26.89 km of storm drains in the Bandarban Municipality area. The drain system in Bandarban Municipality is not network type. There is no branching. Every drain is a single branch drain and discharges stormwater individually from a particular catchment directly to khal / river. Major portion of the drains have been constructed with the Government contribution to development program. Also during recent years, drains have been implemented under the Municipal Service Project (MSP) of LGED. The distributions of existing drains among different wards are presented in Table 1.

Table 1 : Distribution of existing storm drains of Bandarban Municipality

Ward No	Existing Drains		Proposed Drains	
	No of drains	Total Length (m)	No of drains	Total Length (m)
1	5	1535	20	4400
2	7	3794	03	535
3	6	2051	10	1699
4	20	1367	05	614
5	16	2681	14	3475
6	17	7380	08	3316
7	9	3724	05	1407
8	4	1603	05	1067
9	5	2750	08	1280
Total	89	26885	78	17793

Source : LGED, 2006a

7. Introduction to Multi-Criteria Analysis

Multi-Criteria Analysis (MCA) is a decision-making tool developed for complex multi-criteria problems that include qualitative and quantitative aspects of the problem in the decision-making process (Mendoza and Macoun, 1999). It is the formal technique recommended for evaluating strategies and ranking them according to multiple decision criteria. MCA is a comprehensive and effective means of structuring a decision problem by providing a transparent method of determining objectives and criteria. It serves as an ideal platform for participatory planning, involving stakeholders, technical experts and analysts. Another important advantage of MCA is that it does not require all effects to be translated into a common unit of value or significance. This allows the analyst to work with different kinds of indicators and units of measurement. National Water Policy of Bangladesh (Ministry of Water Resources, 1999) has emphasized multi-criteria decision making in water management.

8. Steps of Multi-Criteria Analysis

The following steps are generally followed for conducting a Multi-Criteria Analysis:

- a) Determination of the scores with respect to the criteria
- b) Determination of the standardized scores
- c) Determination of the weights for criteria
- d) Ranking based on the total score

In Multi-Criteria Analysis, the score of each criterion is multiplied by the weight of that criterion and then all those weighted scores are added together to get overall value.

9. Scale of Criteria Measurement

Five criteria have been selected to assess extent of storm flood hazard. List of criteria and their indicators is given in Table 2. A scale of 0 to 20 has been adopted for every criteria so that the range of total score based on five

criteria becomes 0 to 100. The values of the criteria have been standardized to express their magnitude in the range of 0 to 1. Then the standardized value has been multiplied by 20 to bring in the scale of 0 to 20. Logic behind the criteria selection and the procedure followed to estimate their magnitude are discussed in the following section.

9.1 Drain Deficiency Criterion

Absence of drain is the main cause of storm waterflood. The shortage of drain in a Ward is the indicator of drain deficiency. The Ward with a greater shortage is likely to be more prone to storm floods. Therefore the Ward with less drain facility should get higher priority in drain construction.

This criterion has been calculated by the following equation.

$$DD_k = [1 - (E_k / T_k)] * 20 \quad \dots \dots \dots \rightarrow (1)$$

Where, DD_k = Drain Deficiency in the k-th Ward

E_k = Length of existing drain in meter in the k-th Ward

P_k = Length of proposed drain in meter in the k-th Ward

T_k = Length of total requirement of drain in meter in the k-th Ward
 $= E_k + P_k$

9.2 Flood Magnitude Criterion

Flood hazard is also dependent on flood magnitude which is reflected by flooded area and depth of flood. The intensity of hazard increases with the increase of flood depth. It has been known from the consultation meeting with local people that no damage has been occurred for less than 0.3m flood depth. A minimum flood depth of 0.3m has been considered as a threshold value for flood hazard. The magnitude of this criterion has been standardized by dividing by the largest value among all drain catchments. This criterion has been calculated by the following equation.

$$FM_i = (A_i / A_{max}) * 20 \quad \dots \dots \dots \rightarrow (2)$$

Where, FM_i = Value of flood magnitude criterion for the catchment of i-th drain.

A_i = Area in hector in the catchment of i-th drain subject to flood depth of at least 0.3m or runoff way in hills

A_{max} = Maximum value of A_i among all drain catchment.

9.3 Population Suffering Criterion

People living in the area subject to storm flood suffer directly by the flood. This type of suffering is a major concern. The number of people in the flooded area of the catchment of drain has been considered as an indicator of this criterion. But it is a difficult task to measure the actual number of people in the flooded part of a catchment of a proposed drain. To overcome the problem, the population density of a Municipality's Ward as per Community Series of Bangladesh Bureau of Statistics (BBS, 2001) has been used to estimate the number of people in the flooded area. The area subject to flood is multiplied by population density of a Ward to get the number of the population exposed to flood. The magnitude of these criteria has been standardized by dividing by the largest value among all drain catchments.

This criterion has been calculated by the following equation.

$$PS_i = (NP_i / NP_{max}) * 20 \quad \dots \dots \dots \rightarrow (3)$$

Where, PS_i = Value of population suffering criterion for the catchment of i-th drain.

NP_i = Number of population exposed to flooding or runoff way in hills in the catchment of i-th drain.

NP_{max} = Maximum value of NP_i among all drain catchments.

9.4 Damage Characteristics Criterion

Flood damage depends on the land use distribution in the flooded area. So the land use distribution in the flooded area has been taken as the indicator of flood damage characteristics. Land use has been grouped into three categories: commercial, residential and agricultural/forest. Storm flood damage data is not available for Bandarban Municipality. Weighting factors for different land use categories have been estimated based on observed damage cost per unit land area for land use categories in Dhaka City (JICA, 1991). The estimated weighting coefficients are 0.60, 0.33 and 0.07 for commercial, residential and agricultural / forestry land use respectively. The magnitude of the damage characteristic criterion has been standardized by dividing by the largest value among all drain catchments. This criterion has been calculated by the following equation.

$$DC_i = (DM_i / DM_{max}) * 20 \quad \dots\dots\dots \rightarrow (4a)$$

$$DM_i = A_{c-i} * 0.60 + A_{r-i} * 0.33 + A_{a-i} * 0.07 \quad \dots\dots\dots \rightarrow (4b)$$

Where,

DC_i = Value of damage characteristics criterion in the catchment of the i-th drain.

DM_i = Value of damage for flooding in the catchment of i-th drain.

A_{c-i} = Area in hectare of the Commercial Land in the flooded catchment or runoff way in hills of the i-th drain.

A_{r-i} = Area in hectare of the Residential Land in the flooded catchment or runoff way in hills of the i-th drain.

A_{a-i} = Area in hectare of the Agricultural / Forest Land in the flooded catchment or runoff way in hills of the i-th drain.

DM_{max} = Maximum value of DM_i among all drain catchments.

9.5 Social Vulnerability Criteria

The poor people, particularly the slum dwellers, are most vulnerable to flood hazards. It takes quite a long time for them to recover from the disruption due to flood hazards. The equity principle emphasizes attention to vulnerable sections of the society because of their inability to withstand the adverse impacts of hazards. So the slum area needs special attention in flood hazard management. The Poverty Reduction Strategy Paper (Planning Commission, 2005) also emphasized access to physical infrastructure facilities for poor women, slum-dwellers and poor neighborhoods.

The total population of slum areas in Bandarban Municipality is 2,380 and the total number of households is 567 as discussed in section 2.3.3. There are 29 slums in Bandarban Municipality which are characterized by a severe lack of basic amenities like roads, drainage, street light, dustbins, water supply, tubewell, sanitary latrines and others (LGED, 2005a). The slum dwellers suffer from different types of diseases. To improve the environment of the slum area, storm drainage facilities need to be implemented on a priority basis. The number of slum households in the catchment of a drain has been collected from Poverty Reduction Action Plan (LGED, 2005a).

Social vulnerability criterion has been calculated along with standardization by the following equation.

$$SV_i = (NS_i / NS_{max}) * 20 \quad \dots\dots\dots \rightarrow (5)$$

Where, SV_i = Value of the social vulnerability criterion for the catchment of the i-th drain.

NS_i = Number of slum households in the catchment of i-th drain.

NS_{max} = Maximum value of NS_i among all drain catchments.

Table 2 : Criteria and Indicators for Flood Hazard Assessment

Criteria	Indicator
Drain Deficiency	Shortage of drain in percent of total requirement
Flood Magnitude	(a) Area subject to runoff way in hill slope area
	(b) Area subject to at least 0.3m of flood depth
Population Suffering	(a) Number of population in the runoff way in hill slope area
	(b) Number of population in the flooded area
Damage Characteristics	(a) Landuse distribution in the runoff way in hill slope area
	(b) Landuse distribution in the flooded area.
Social Vulnerability	Number of slum household in the catchment of proposed drain.

10. Procedure of Multi-Criteria Prioritization of Drain Works

The storm drain network in Bandarban Municipality consists of individual drain system. There is no branching in the network. Every individual drain discharges directly to the canal or river. Every proposed drain ranked separately based on the following equation.

$$S_i = DD_k + FM_i + PS_i + DC_i + SV_i \quad \dots \dots \dots \rightarrow (6)$$

Where S_i is the score of the i -th drain. Values of the five indicators in the right hand side of the equation have been calculated based on equation (1) to (5). Values of DD_k are equal for all drains in the k -th Ward. The scale of S_i is 0 to 100.

11. Priority Ranking of Drain Construction

The steps of calculation are shown shortly in Figure 3.

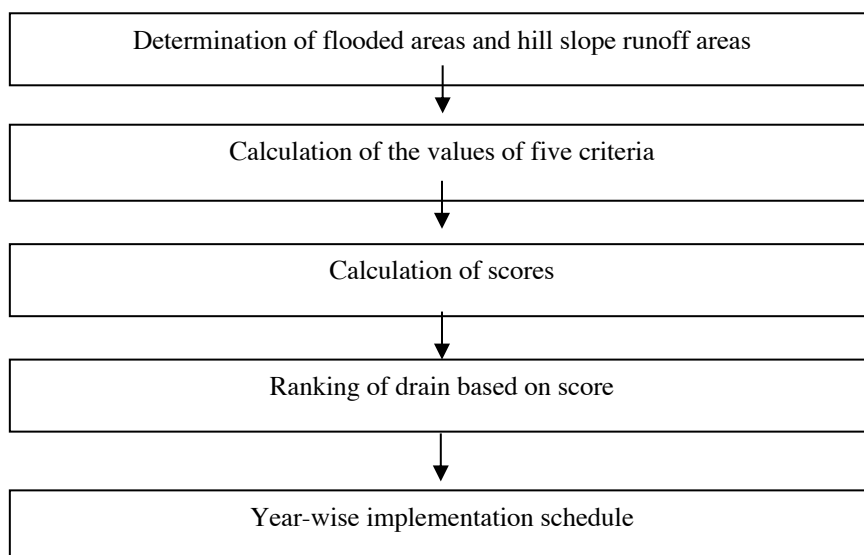

Figure 3 : Main Steps of Multi Criteria Prioritization

12. Year-wise Implementation Schedule

How many drains can be constructed in a year is dependent on the available budget for that year. So the year-wise implementation schedule of drain construction over the planning period is to be determined based on year-wise budget. The ranked series of drains are to be divided into segments, and the number of segment is equal to the

number of year in the planning period. The segmentation is to be made such that the total drain length in a segment can be implemented using the budget available for the year.

Table 3 : Storm Drain Implementation Schedule

Implementation Year	Drain to be constructed in different Wards									
	W-1	W-2	W-3	W-4	W-5	W-6	W-7	W-8	W-9	Total Length (m)
1 st						60				2.70
2 nd	17		25		50, 44	54	64			1.93
3 rd	1				49	55		66	75, 72	1.62
4 th	3		24		43, 41, 51, 40					1.71
5 th	20, 12, 18		26, 29, 27		45, 42			67, 68		1.90
6 th	14, 10, 16, 19, 15, 8	21			52		65		78, 77, 73	1.78
7 th	11, 7, 9				39		61, 63	69		1.52
8 th	2, 4, 6		32, 31	35, 36			62		71	1.72
9 th	13, 5	22	33, 30, 28		46, 47, 48	58, 57		70		1.75
10 th		23		38, 37, 34		53, 56, 59			78, 74	1.16
Total Length (m)	4.40	0.54	1.70	0.61	3.48	3.31	1.40	1.07	1.28	17.79

13. Conclusion

Storm water flood hazard during monsoon is a major concern in Bandarban Municipality. Responses received from 190 households during a questionnaire survey, reveal that 33 out of 67 paras get flooded during monsoon. The main causes of floods are the absence of drain and lack of proper operation and maintenance of drain. The major consequences are an inconvenience to movement, damage due to intrusion of floodwater into home/market and environmental sufferings.

To overcome the problem of the non-availability of the data on flooded areas, the prediction of the flooded area has been made based on the contour map. Prediction for a rainfall of 123 mm shows that 5.32% areas of the topographic zones get flooded. Major portion of non-flooded area is hill area. The high slope areas also suffer from damage because of heavy runoff flow.

Main outcome of this study is the development of a multi-criteria decision aid to determine the priority order of the storm drain to be constructed in the future. Five criteria have been selected to represent storm flood hazards that serve as the basis for prioritization. The criteria are drain deficiency, flood magnitude, population suffering, damage characteristics, and social vulnerability. The 78 new drains that are to be constructed over 10 years in Bandarban Municipality, has been ranked in priority order by applying the method. The ranked series is to be divided into 10 segments such that the total length of drains in a segment can be implemented using the budget available for the year corresponding to that segment.

References

- BBS (2001), Bangladesh Bureau of Statistics, Community Series, Bandarban District.
- Chaw, V.T., Maidment, D.R., and Mays, L.W. (1988), Applied Hydrology, McGraw Hill Pub Co. New York.
- JICA (1991), Master Plan for Greater Dhaka Protection Project (Study in Dhaka Metropolitan Area), FAP 8A, Main Report and Supporting Reports I & II, FPCO, Dhaka.
- LGED (2005a), Socio-Economic Survey for Bandarban Municipality, ADB Assisted Urban Governance and Infrastructure Improvement Project, LGED, Dhaka.
- LGED (2006a), Drainage Master Plan for Bandarban Municipality, ADB Assisted Urban Governance and Infrastructure Improvement Project, LGED, Dhaka.
- LGED (2006b), Chittagong Hill Tracts Census Indicators 2001 & Trends (1981-2001), Geographical Information System (GIS) Unit, LGED, Dhaka.
- Ministry of Water Resources (1999), National Water Policy, Government of the People's Republic of Bangladesh.
- Mendoza, G. A. and Macoun, P. (1999), Guidelines for Applying Multi Criteria Analysis to the Assessment of Criteria and Indicators, the Criteria & Indicators Toolbox Series, Published by Center for International Forestry Research (CIFOR), Jakarta Indonesia.
- Planning Commission (2005), Unlocking the potential, National Strategy for Accelerated Poverty Reduction, Planning Commission, Government of the People's Republic of Bangladesh.



Risk Management: Comparative Study between Islamic Banks and Conventional Banks

Zainul Kisman¹

¹Universitas Trilogi. Email: zainulkisman@trilogi.ac.id

Abstract

In the future the role of Islamic Banking / Sharia should be developed as an alternative source of corporate financing in addition to conventional bank financing. The role of this institution is increasing because based on survey Islamic Development Bank for certain types of risks attached to Islamic Bank is relatively easier to manage it compared with conventional banks. Easier risk management results in lower financing risks, making it easy to compete because it is profitable for banks, corporations and the economy. The survey results show that in Islamic Bank: Capital is quite good, Capital and Liquidity risk is low. Credit, market and operating risk moderate. More concerned about credit and liquidity risk. The most commonly used risk management techniques are Credit rating.

Keywords: Risk Management, Islamic Bank, Conventional Bank

I. Introduction

Banks in accordance with Islamic law have long been present as alternatives to conventional financial institutions. The presence of this institution is, among others, providing services relating to investment or financing based on Sharia (Dahlan, 2005; Dendawidjaya, 2000)). The increasingly globalized and increasing world trade results in increasingly large competition and risks faced by the business world. Increased risk results in banks, both conventional and sharia being demanded to be able to compete in serving the business world so that the transaction risks they face can be minimized (IDB, 2001). In order to provide financial services (financial services) with low costs, conventional and Islamic banks are required to be able to issue contracts and instruments that can minimize financial risk.

The extent to which Sharia Banks can compete compared to its competitors in the future depends on how the institution manages its operational and other inherent risks.

The purpose of this paper is as follows:

- In the first part, it is a preliminary background that explains how important the role of Islamic banks is in supporting business world financing as an alternative to financial institutions conventional.
- The second part discusses the unique characteristics of the risk of Islamic banks compared to conventional banks.

- In the third part, explain the results of a research survey from the Islamic Development Bank on the risk management practices of the Islamic Bank.

II. Unique Characteristics of Sharia Bank Risk.

In its activities, banks face risks that have the potential to cause losses. According to Kisman and Shintabelle (2015) along with Kisman (2016), there are risks that can be avoided or minimized (unsystematic risk) and some that cannot be avoided (systematic risk). For this unavoidable risk, banks are required to be able to manage it without reducing the expected return. In order to achieve this goal, bank management is required to understand risk and how to manage it.

According to the Islamic Development Bank (2001), Olsson (2002), Jorion (2002) and William et al (2009) risk is the probability of an event occurring that can cause a loss. When an undesirable event occurs, it will cause a loss if not anticipated and managed properly.

For banks, these risks are events or events that can be either anticipated or not, which can harm the bank both for its income and its capital today or for the future or for the future. In overcoming this problem banks must continuously observe developments in both their internal and external conditions (Robock et al, 1983).

Not only conventional banks face this risk problem but also Sharia banks are also demanded to be able to manage risk, starting from identifying it, measuring it up to controlling it.

Viewed from the environment that affects banks, the risk is divided into two:

- (1) Systematic Risk, which is the risk that comes from macro situations: political situation, government economic policy, changes in market conditions, recession.
- (2) Unsystematic Risk, namely risks originating from within the company itself, micro risk and this type of risk can be minimized by diversification.

Judging from the bank's business activities, the risks in this bank can be grouped as follows:

- (1) Credit Risk (Financing Risk or Financing risk in Sharia banks)
- (2) Market Risk
- (3) Liquidity Risk
- (4) Operational Risk
- (5) Legal Risk
- (6) Reputation Risk
- (7) Strategic Risk
- (8) Compliance Risk

(1) Credit Risk

Risk, which is a loss experienced by banks because the debtor is unable to pay the loan principal or interest on the loan. The risk of default is due to banks being too aggressive so that they ignore the prudential banking principle. And aggressiveness occurs because of the possibility of banks experiencing overvalued conditions so that they are overshadowed by fears of rising cost of loanable funds.

Credit risk also arises due to conditions in the real sector that are sluggish or not conducive. The features decreased and the cash flow was not sufficient to pay the interest and principal of the loan. Rising interest rates that result in increased lending rates or base lending rates also contribute to non-performing loans. Credit risk is increasing for banks because the collateral is inadequate and even worse the legal status is unclear. All these problems will make it difficult for the bank when it is going to restructure credit or when it is carried out.

Conventional banks that most of their income comes from loan interest income, conventional banks are required to pay considerable attention to this credit problem and its distribution. An increase in bad loans means that banks

must increase their capital. If the owner is unable to make additions, the bank's permission will be revoked. So credit risk here raises capital risk.

For a Sharia bank, this credit risk (or it is called in a Sharia Bank as Financing Risk) is a specific problem. For example:

- (a) The bank has delivered the goods but the payment was not made according to the agreement. (Murabahah)
- (b) The bank failed to provide goods according to the agreement (both time, quality and specifications).
- (c) Banks run the risk of damage to goods rented/leased (Ijarah).

(2) Market Risk

Losses experienced by bank portfolios due to changes in market variables such as interest rates, inflation, and exchange rates.

(3) Liquidity Risk

Liquidity shows the ability of banks to meet their obligations which will soon mature in the short term. The bank is liquid if it can meet its funding needs immediately to meet the needs of its depositors. The not liquid bank will cause a decrease in bank credibility which will ultimately cause the bank to be rushed and bankrupt.

In Indonesia, this liquidity risk problem for conventional banks is easier to overcome compared to Islamic banks. Because conventional banks can easily overcome it by entering the interbank call money market. As with Islamic banks, although there are sharia interbank money market but participants is still limited as well as its volume.

(4) Operational Risk

These risks include human errors, system failures, and inadequate procedures and controls that will affect bank operations. Included in this risk are errors in information systems, internal controls, human errors, system failures, and inadequate procedures and controls.

(5) Legal Risk

The loss of a bank due to bank for lawsuits, weaknesses in legal or juridical aspects. Lack of regulations, legislation and weak contracts.

(6) Reputation Risk

Risk due to the bank's declining reputation or the existence of negative publications or wrong perceptions about banks.

(7) Strategic Risk

Risk experienced by banks because the bank fails to implement its strategy. For example, it failed in achieving the target set. The failure occurred due to a lack of sensitivity of banks to changes that occur in their environment.

(8) Compliance Risk

Risk of losses that occur because banks do not comply with the provisions or regulations in force. Both internal provisions (from company management) and external (central banks).

Based on Bank Indonesia Report, Islamic banking is unique risks, for example:

- Potential for investment risk (income risk/equity investment risk)
- Specific liquidity risks associated with differences in return (rate of return risk)
- Specific market risks from changes in inventory prices
- Specific legal risks associated with transactions using sharia principles
- Reputational risk is also associated with compliance with sharia principles in bank operations.

III. PROFILE OF RISK MANAGEMENT BANK SYARIAH:**Interpretation of Survey Results of Islamic Development Bank.**

This section will explain the results of a survey of several Islamic banks (28 countries). This survey wants to see the practice of risk management in these financial institutions. The results are as follows:

Table 3.1: Basic Balance Sheet Data

	Number of Observation	Average
Assets (Million \$)	15	494.2
Capital (Million \$)	15	73.4
Cap./Asset ratio (%)	15	32.5
Maturity of Assets		
<1 Years	12	68.8%
1 - 3 Years	12	9.8
> 3 Years	12	21.4

Source: Islamic Development Bank (IDB, 2001).

From table 3.1 above it can be seen that the average of the 15 institutions observed is the average total assets of \$ 494.2 Million with an average Capital of \$ 73.4 Million. The amount of Capital / Asset ratio is 32.5%. This figure for bank size is quite large. This shows that Islamic banks viewed from the capital are quite safe.

At the bottom, it is seen that the structure of Islamic bank assets is dominated by assets with a short-term lifespan of 68.8%. This shows the high liquidity of Islamic banks. High liquidity will usually have an impact on the low profitability of banks.

Table 3.2: Risk Perception - Overall Risk Faced by Islamic Financial Institution

	Average Rank
Credit risk	2.71
Liquidity risk	2.81
Market risk	2.50
Operational risk	2.92

Source: IDB (2001); 1 = not serious 5 = Critically serious

From table 3.2 above it can be seen that in the sharia banks, the highest risk is found in operational risk and lowest in market risk. The high operational risk is due to the fact that banks that have studied the system and procedures are incomplete, so this operational risk often arises. Low market risk indicates the low sensitivity of Islamic banks to changes in the market. Liquidity risk is included in the high category indicating less aggressive Islamic banks in lending.

Table 3.3: Maintaining an Appropriate Risk Measuring, Mitigating, and Monitoring Process Risk Report

Capital at Risk Report	64.7%
Credit Risk Report	70.6
Market Risk Report	29.4
Interest rate Risk Report	23.5
Liquidity Risk Report	76.5
Foreign Exchange Rate Risk Report	41.2
Operational Risk Report	17.6
Country Risk Report	35.3

Source: IDB (2001)

From table 3.3 above, it can be seen that the sharia banks that were studied mostly reported or monitored Liquidity risk and Credit risk. The lowest operational risk is only 17.6%.

Table 3.4: Maintaining an Appropriate Risk Measuring, Mitigating, and Monitoring Process Measuring and Management Techniques

	Percentage of Total
The credit rating of Prospective Investors	76.5%
Gap Analysis	29.4
Duration Analysis	47.1
Maturity Matching Analysis	58.8
Earning at Risk	41.2
Value at Risk	41.2
Simulation Techniques	29.4
Estimates of worst-case scenarios	52.9
Risk-Adjusted Rate of Return on Capital	47.1

Source: IDB (2001)

From table 3.4 it appears that Islamic banks in managing their risks more often use Credit rating in assessing debtors and the second technique in minimizing the risks. do Maturity Matching Analysis. While Gap Analysis and Simulation Techniques are rarely used.

IV. Conclusion

Based on the discussion above, it can be concluded as follows:

1. In the future, the role of Islamic banks needs to be developed as an alternative source of corporate financing besides conventional bank financing.
2. For certain types of risks inherent in Islamic banks, it is relatively easier to manage compared to conventional banks. The low risk of financing has made this bank easy to compete.
3. The survey results show that in Islamic banks:
 - Capital is quite good: Capital risk is low.
 - Low liquidity risk resulting in a low profitability rate.
 - Credit, Liquidity, Market and Operational risk are neither high nor too low (moderate).
 - Of the several types of risk, more concerned with Credit and Liquidity risk.
 - The risk management technique that is often used is Credit Rating.

References

- Siamat, Dahlan; Financial Institution Management, Issue 5, Publisher Institute, FEUI, Jakarta, 2005.
- Dendawijaya, Lukman; Banking Management , Ghalia, Jakarta, 2000.
- Islamic Development Bank; Risk Management, Jeddah, 2001.
- Williams, Smith, and Young (1998). Risk Management and Insurance. 8th Ed. Mcgraw-Hill.
- Olsson, Carl (2002). Risk Management in Emerging Markets. Prentice-Hall.
- Jorion, Philippe (2002). Value at Risk. Mc. Graw-Hill.
- Robock, Stefan H. & Kenneth Simond. (1983). International Business and Multinational Enterprises. 3rd Ed. Irwin



The Cointegration Relationship and Causal Link of Internet Penetration and Broadband Subscription on Economic Growth: Evidence from ASEAN Countries

Aileen L. Camba¹, Abraham C. Camba, Jr.¹

¹ Department of Economics, College of Social Sciences and Development, Polytechnic University of the Philippines, Sta. Mesa, Manila, Philippines

Correspondence: Abraham C. Camba, Jr., 512 Unit Villa Alicia III, P. Tuazon Avenue, Bgry. Kaunlaran, Quezon City, Metro Manila, Philippines, 1111. Tel: (632)9175408300. E-mail: accamba@pup.edu.ph

Abstract

This study explores the cointegration relationship and causal link of internet penetration and broadband subscription to economic growth from the 10 countries of ASEAN for the period 2000-2016. A pooled multiple regression model with GDP growth as a function of internet penetration and broadband subscription was developed. The Johansen-Fisher panel cointegration was applied to determine the presence of a long-run equilibrium relationship among the three variables and the direction of causality was identified by estimating the panel-based vector error correction model (VECM). Results from cointegration test indicate a long run equilibrium relationship between internet penetration, broadband subscription and economic growth. The causality test reveals there is long run causality running from internet penetration and broadband subscription to economic growth. In the short-run, broadband subscription causes economic growth in the ASEAN countries. However, internet penetration has no causal link with economic growth in the short-run during the period 2000-2016. The findings are supportive of the claim that internet penetration and broadband connections are engine of economic growth and are rapidly transforming ASEAN economies. Based on these findings, this study recommends that ASEAN governments should be supportive on policies that promotes better internet and broadband infrastructure to achieved short and long-run economic growth.

Keywords: ASEAN, Broadband Subscription, Causality, Economic Growth, Internet Penetration, Panel Cointegration

1. Introduction

Modern theories of endogenous growth acknowledge that adoption of new technologies (i.e., digital technologies) enhance the innovative capacities of the economy through knowledge spillover, development of new products and processes, and business models to promote growth. Thus, the dramatic expansion of digital technologies has facilitated searching, matching, and sharing of information and contributed to greater organization and collaboration among economic agents—influencing how firms operate, people seek opportunities, and citizens

interact with their governments (Benhabib & Spiegel, 2005; World Bank, 2016; Kelly, Liaplina, Tan, & Winkler, 2017).

In particular, internet penetration and broadband subscription have vast potential for inclusive growth and socio-economic development because they increase productivity and contribute to the overall economic growth by connecting remote areas to markets, promoting access to social services, expanding educational opportunities, establishing platforms for innovation and enabling people's access to government services (Choi & Yi, 2009; Elgin, 2013; Zhang, 2013). During the 2000-2016 period, ASEAN countries have adopted policies that have led to the massive growth of the use of the internet in their countries. Governments of ASEAN have recognized the significant growth potential of the internet along with other ICT infrastructure (i.e., broadband) to their economies. Given the diversity of economic growth around ASEAN, perhaps it is not surprising that internet penetration and broadband subscription isn't evenly distributed across the region (see Figure 1).

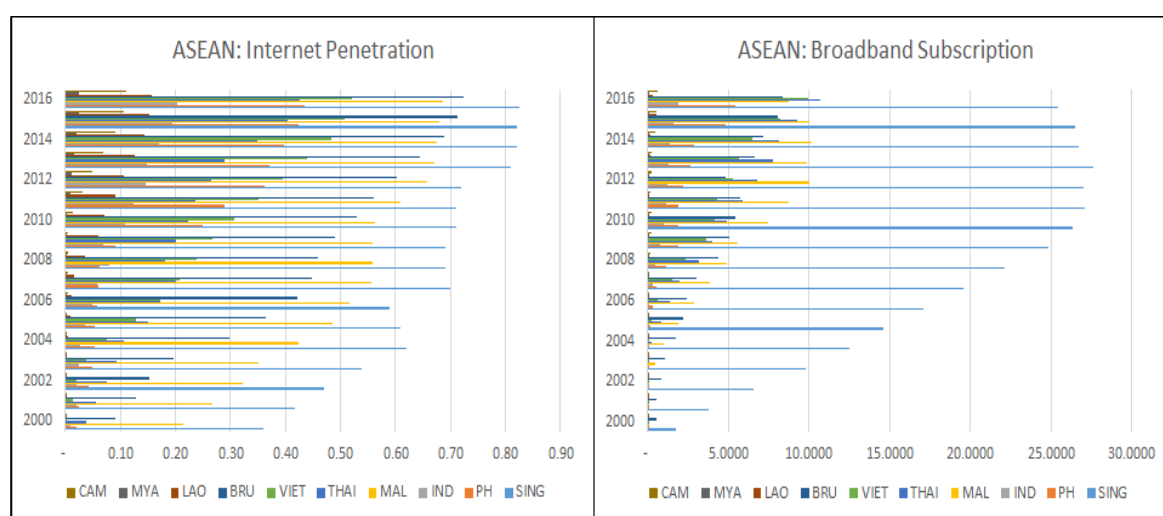

Figure 1. Digital Divide within ASEAN

ASEAN has to work harder to erase the digital divide and raise its game across the board to enhance intra-regional connectivity. The risk of a widening digital divide within ASEAN can undermine plans to turn the digital economy into an engine of growth. Thus, this study explores the cointegration relationship and causal link of internet penetration and broadband subscription to economic growth from the 10 countries of ASEAN for the period 2000-2016.

2. Method

This study used dataset of 10 ASEAN member countries for the period 2000 to 2016. The core variables used in the study were real GDP growth rate (%), internet penetration (% of population) and fixed broadband subscription (per 100 people). Data for these variables were obtained from the World Development Indicators (WDI) by the World Bank.

2.1. Panel Pooled Multiple Regression Model

A pooled multiple regression model with GDP growth (GDPGRW) as a function of internet penetration (IPEN) and fixed broadband subscription (BROAD) was developed. Thus, the economic growth equation in functional form is:

$$\text{GDPGRW} = f(\text{IPEN}, \text{BROAD}) \quad (1)$$

where:

GDPGRW = real GDP growth rate (%)

IPEN = internet penetration (% of population)

BROAD = fixed broadband subscription (per 100 people)

Intuitively, the above functional model means that economic growth is driven by internet penetration (IPEN) and broadband subscription (BROAD). Internet penetration and broadband subscription allows the generation and distribution of decentralized information and ideas in markets increasingly relying in information as an input. In light of this, economic growth is accelerated by facilitating the development and adoption of innovation processes. Internet and broadband subscription may accelerate the distribution of ideas and information and foster competition for and development of new products, processes, and business models, thereby further promoting long-run economic growth. In its stochastic form, it can be mathematically expressed as follows:

$$GDPGRW_{it} = \alpha_0 + \alpha_1 IPEN_{it} + \alpha_2 BROAD_{it} + \varepsilon_{it} \quad (2)$$

where:

α_0 , α_1 , and α_2 = parameter estimates

ε_{it} = error term

The subscripts i and t represent ASEAN country ($i = 1...10$) and time period (2000-2016), respectively. The standard procedures required us to conduct panel unit root test, panel cointegration test, panel vector error correction model and Wald test.

2.2. Unit Root Test

This study uses the more reliable and well-behaved panel unit root tests such as those developed by Levin, Lin & Chu (2002) and Im, Pesaran & Shin (2003). An alternative approach to panel unit root tests applied in this study are the ADF (augmented Dickey-Fuller)-Fisher and ADF-PP (Phillips-Perron) to ensure comparison and validation of results with a view to further create consistency (Demetriades & Fielding, 2012).

2.3. Johansen-Fisher Panel Cointegration

Where the unit root test gives variables that are of order one integration I(1), then cointegration analysis was applied to determine the presence of a long-run equilibrium relationship among the three variables (real GDP growth rate, internet penetration and fixed broadband subscription). Madalla and Wu (1999) relied on the Johansen (1988) test for cointegration to consider the suggestion of Fisher (1932) to combine trace test and max-eigen statistics to test for cointegration in full panel by combining individual cross-sections for cointegration. Johansen-Fisher cointegration test type aggregates p-values of individual Johansen maximum likelihood cointegration test statistics. Unlike Pedroni (2004) and Kao (1999) whose cointegration tests are residual based, the Johansen-Fisher cointegration test is system based cointegration for the whole panel (Madalla & Kim, 1998).

2.4. Panel Causality

The direction of causality was identified by estimating the panel-based vector error correction model (VECM) and used to conduct the causality of internet penetration and fixed broadband subscription on real GDP growth rate. The empirical model is represented by the following equations:

$$\Delta GDPGRW_{it} = \lambda_{1j} + \sum_{k=1}^m \varphi_{11ik} \Delta GDPGRW_{it-k} + \sum_{k=1}^m \varphi_{12ik} \Delta IPEN_{it-k} + \sum_{k=1}^m \varphi_{13ik} \Delta BROAD_{it-k} + \psi_{1i} \varepsilon_{it-1} + \mu_{1it} \quad (3)$$

$$\Delta IPEN_{it} = \lambda_{2j} + \sum_{k=1}^m \varphi_{21ik} \Delta IPEN_{it-k} + \sum_{k=1}^m \varphi_{22ik} \Delta GDPGRW_{it-k} + \sum_{k=1}^m \varphi_{23ik} \Delta BROAD_{it-k} + \psi_{2i} \varepsilon_{it-1} + \mu_{2it} \quad (4)$$

$$\Delta BROAD_{it} = \lambda_{3j} + \sum_{k=1}^m \varphi_{31ik} \Delta BROAD_{it-k} + \sum_{k=1}^m \varphi_{32ik} \Delta GDPGRW_{it-k} + \sum_{k=1}^m \varphi_{33ik} \Delta BROAD_{it-k} + \psi_{3i} \varepsilon_{it-1} + \mu_{3it} \quad (5)$$

where Δ = denotes first differences and k = the optimal lag length. Equations 3 to 5 allows to test the short-run and long-run causality which is determined by investigating the significance using the probability value on the coefficient, ψ , of the error correction term, ε_{it-1} , in the equations.

3. Results and Discussion

3.1 Pooled Multiple Regression Model

The results of the regression in Table 1 shows that internet penetration (IPEN) has a significant and negative effect on GDP growth (GDPGRW) as indicated by the coefficient value of -9.1690 and t-statistic = 3.5327 in absolute term with probability = 0.0005. This means that a 1 percentage point increase in internet penetration lowers economic growth by 9.1690 percentage points. This negative effect can be attributed to the presence of a digital divide in ASEAN countries due to high income inequality (Noh and Yoo, 2008). The rapid expansion of internet usage has resulted in the creation of social inequality- popularly known as digital divide - a phenomenon that have the potential to weaken growth and productivity (Doong & Ho, 2012; Bowles, 2012; Shahiduzzaman & Alam, 2013).

Table 1. Pooled Least Squares Regression Results

Variable	Coefficient	Std. Error	t-statistics	Prob.
C	7.2943	0.5828	12.5148	0.0000
IPEN	-9.1690	2.5955	-3.5327	0.0005
BROAD	0.1683	0.0983	1.7127	0.0888
AR(1)	0.4768	0.0686	6.9461	0.0000
R-squared = 0.4182		F-statistic = 37.3737	DW = 2.1428	
Adjusted R-squared = 0.4069		Prob. (F-statistic) = 0.0000		

As for broadband subscription, its positively and statistically influence GDPGRW at 10 percent level of significance. A 1-unit increase in the number of broadband subscription prompted an increase in economic growth by 0.1683 percentage points. The widespread adoption of broadband (i.e. a form of high speed internet) has been linked with economic growth and social wellbeing (Dwivedi, Alsudairi, & Irani, 2009; Holt & Jamison, 2009). The availability of high speed broadband for business and households is a well understood and significant factor to encourage rapid economic growth (Bowles & Wilson, 2010).

The computed adjusted coefficient of determination (Adj. R-squared = 0.4069) shows that 40.69 percent of the total variation in the dependent variable are accounted for by the variation in the explanatory variables while 59.31 percent of the total variation in the GDPGRW is attributable to the influence of other factors not included in the regression equation. The F-statistic = 37.3737 is significant at 1 percent level. This implies that internet penetration and broadband subscription collectively influenced economic growth overtime. These findings are supportive of the claim that internet penetration and broadband connections are an engine of economic growth and rapidly transforming ASEAN economies. The computed DW statistic = 2.1428 indicates the absence of both positive and negative autocorrelations.

Figure 2 exemplifies the effect of internet penetration and broadband subscription on GDP growth of the 10 ASEAN countries. Based on the figure, the 17-year pooled least squares regression model appear to fit the actual behavior of the data. Moreover, the residuals of the series are stationary since the fluctuations are more or less on zero, indicating constancy of error variances.

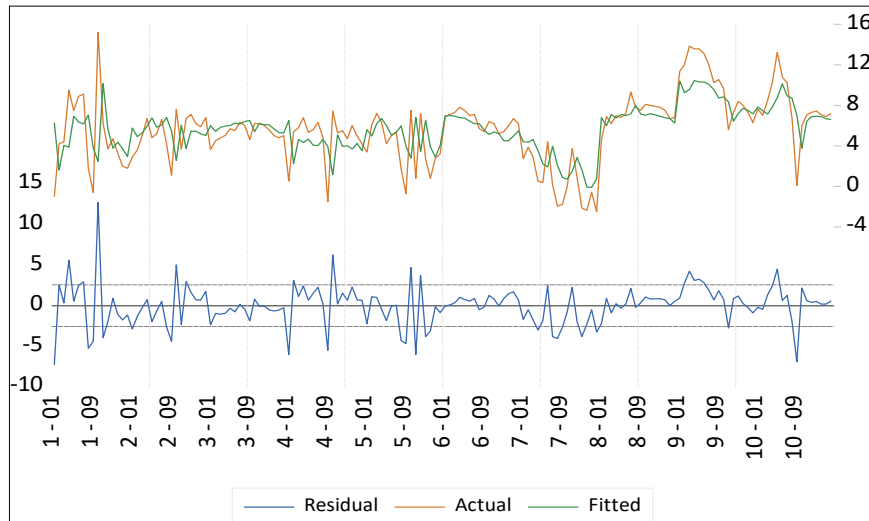

Figure 2. Plot of the Actual, Fitted and Residual for Pooled Regression

3.2 Unit Root Test

We first tested if the relevant variables were stationary as well as determining their order of integration. By looking at Figure 3 one can guess the stationarity or nonstationarity of a series. The nonstationary series GDPGRW, IPEN and BROAD were compared to their stationary series D(GDPGRW), D(IPEN) and D(BROAD). The graph of the series GDPGRW, IPEN and BROAD exhibits a trend suggesting nonstationarity. On the other hand, the graphs of D(GDPGRW), D(IPEN) and D(BROAD) shows pattern with no discernible upward nor downward trend, suggesting stationarity.

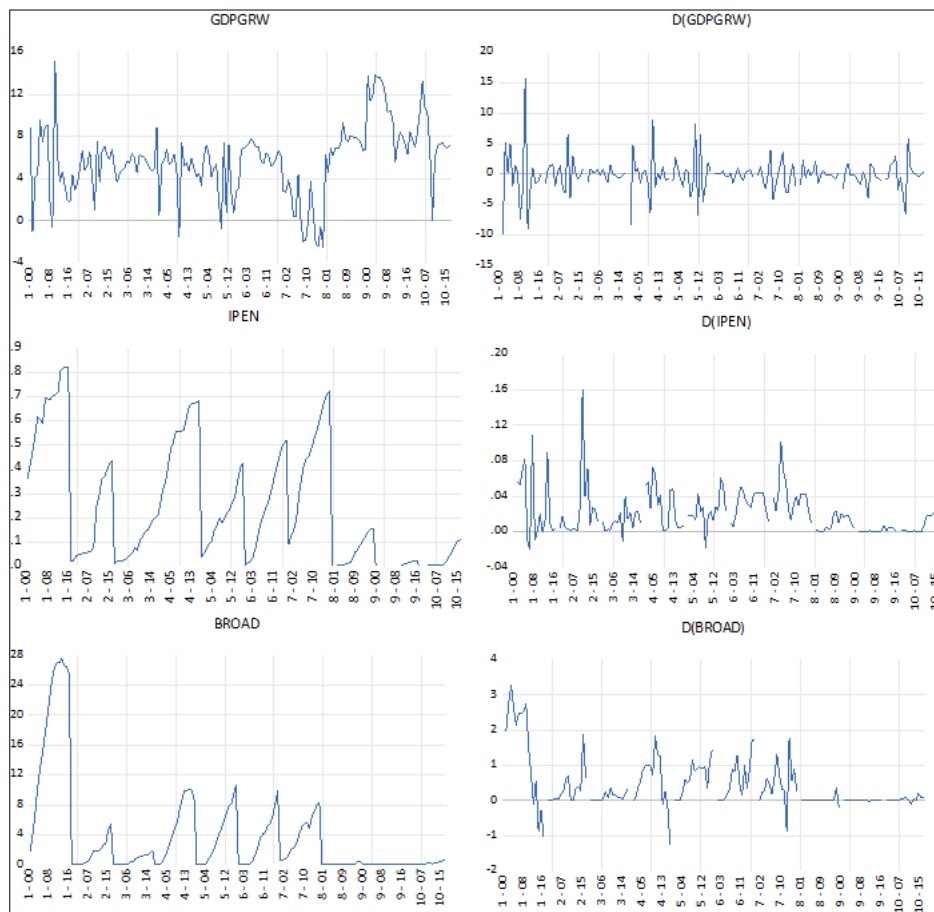

Figure 3. Nonstationary and Stationary Series Plot

The summary of the panel unit test results is presented in Table 2. The results are significant for GDPGRW at levels I(0) signifying the absence of unit root. In the case of IPEN and BROAD are non-stationary at I(0) and must be tested at first difference I(1). All the tests, show that the relevant variables are stationary in first differences, mostly at the 1% level of significance. That is, at I(1) all variables (i.e., D(GDPRW), D(IPEN) and D(BROAD)) are stationary for all the approaches employed signifying absence of unit root at order 1 and meeting the conditions for testing for long-run cointegration tests.

Table 2. Panel Unit Root Results

	Levin, Lin & Chu		Im, Pesaran & Shin		ADF-Fisher		PP-Fisher	
	Stat.	Prob.	Stat.	Prob.	Stat.	Prob.	Stat.	Prob.
At Levels I(0)								
GDPGRW	-5.93	0.00	-4.56	0.00	58.58	0.00	58.81	0.00
IPEN	-0.76	0.99	3.09	0.99	17.47	0.62	18.40	0.56
BROAD	4.03	1.00	7.90	1.00	8.59	0.98	7.52	0.99
At First Difference I(1)								
D(GDPGRW)	-15.09	0.00	-12.18	0.00	138.86	0.00	162.88	0.00
D(IPEN)	-5.12	0.00	-4.56	0.00	56.21	0.00	47.54	0.00
D(BROAD)	-3.16	0.00	-3.27	0.00	51.37	0.00	40.78	0.00

Note: the tests for panel unit roots were specified with individual effects only.

3.3 Johansen-Fisher Panel Cointegration

Table 3 below presents Johansen-Fisher panel cointegration test for potential cointegrating relationships among the variables in level form and first difference. As can be readily seen, both the trace and max-eigen tests suggests that there is a strong cointegrating relationship among these variables. Thus, at least 2 cointegrated relationships can be detected. The null hypothesis of no cointegration is rejected at the 1 percent and 5 percent levels of significance. The findings indicate that there is a cointegration relationship between economic growth and each of the independent variables, internet penetration and broadband subscription, in ASEAN countries. When a cointegration relationship is present, it means that economic growth (GDPGRW), internet penetration (IPEN) and broadband subscription (BROAD) share a common trend and long run equilibrium relationship.

Table 3. Johansen-Fisher Panel Cointegration Results

Hypothesized No. of CE(s)	Trace Test		Max-Eigen Test	
	Stat.	Prob.	Stat.	Prob.
At Levels I(0)				
None	107.80	0.00	80.16	0.00
At most 1	52.95	0.00	39.65	0.00
At most 2	44.66	0.00	44.66	0.00
At First Difference I(1)				
None	104.20	0.00	85.18	0.00
At most 1	43.64	0.00	38.47	0.01
At most 2	31.46	0.05	31.46	0.05

3.4 Panel Causality

From Table 4, the coefficient of ECM (1) is negative 0.219000 and its t-statistic is 3.848640 in absolute term with p-value = 0.0001 which is significant 0.01 level of significance. A negative and significant coefficient of the ECM indicates that any short term fluctuations between the independent variables (i.e., IPEN, BROAD) and the dependent variable GDPGRW will give rise to a stable long-run relationship between the variables. Moreover, we can also say that when C(1) is negative and significant this implies long-run causality running from internet penetration and broadband subscription to economic growth. The speed of adjustment is 0.2190, means that the

whole system is going back to long run equilibrium at the speed 21.90 percent annually. This implies that there has been some disequilibrium in previous years that is now been corrected at the speed of adjustment stated.

Table 4. Vector Error Correction Estimates

	Coefficient	Std. Error	t-statistic	Prob.
C(1)	-0.219000	0.056903	-3.848640	0.0001
C(2)	-0.373024	0.084560	-4.411376	0.000
C(3)	-0.250394	0.075331	-3.323941	0.0010
C(4)	-10.42205	8.874030	-1.174443	0.2409
C(5)	-4.917418	8.706510	-0.564798	0.5725
C(6)	0.083445	0.458752	0.181895	0.8558
C(7)	1.071901	0.490627	2.184760	0.0295
C(8)	-0.306351	0.303335	-1.009942	0.3131
Determinant residual covariance		0.000500		
Equation: $D(\text{GDPGRW}) = C(1)*(\text{GDPGRW}(-1)) + 6.57120030813*\text{IPEN}(-1) + 0.395384523504*\text{BROAD}(-1) - 9.07691329997) + C(2)*D(\text{GDPGRW}(-1)) + C(3)*D(\text{GDPGRW}(-2)) + C(4)*D(\text{IPEN}(-1)) + C(5)*D(\text{IPEN}(-2)) + C(6)*D(\text{BROAD}(-1)) + C(7)*D(\text{BROAD}(-2)) + C(8)$				

3.5 Wald Short-run Causality

Table 5 reports the Wald short run causality results. It shows that broadband subscription causes economic growth in the ASEAN countries. That is, there is short-run causality running from BROAD to GDPGRW. However, internet penetration has no causal link with economic growth in the short-run.

Table 5. Wald Short-run Causality

	Chi-square		
	Value	df	Prob.
IPEN → GDPGRW	2.4464	2	0.2943
BROAD → GDPGRW	11.1492	2	0.0038

4. Conclusion

This paper explored the cointegration relationship and causal link of internet penetration and broadband subscription to economic growth from the 10 countries of ASEAN for the period 2000-2016. A pooled multiple regression model with GDP growth as a function of internet penetration and broadband subscription was developed. The Johansen-Fisher panel cointegration was applied to determine the presence of a long-run equilibrium relationship among the three variables and the direction of causality was identified by estimating the panel-based vector error correction model (VECM). Internet penetration and broadband subscription collectively influenced the economic growth of the ASEAN countries during the period 2000-2016. The findings indicate that there is a long-run equilibrium relationship between economic growth and each of the independent variables, internet penetration and broadband subscription, in ASEAN countries. Moreover, we can also say that there is long run causality running from internet penetration and broadband subscription to economic growth. In the short-run, broadband subscription causes economic growth in the ASEAN countries. However, internet penetration has no causal link with economic growth in the short-run during the period 2000-2016. Based on these findings, this study recommends that ASEAN governments should be supportive on policies that promotes better Internet and broadband infrastructure to further boost economic growth. Likewise, ASEAN governments need to work closely with industry leaders to find ways to proactively promote the growth of internet interconnectivity of the region.

References

- Benhabib, J. & Spiegel, M. (2005). Human Capital and Technology Diffusion. In: Handbook of Economic Growth, Volume 1A, P. Aghion and S.N. Durlauf (eds.), 935-966. Amsterdam: Elsevier. <https://EconPapers.repec.org/RePEc:eee:grochp:1-13>
- Bowles, M. (2012). Digital Economy and Regional Futures: ICT Future Foresight. Innovation and Business Skills Australia: Melbourne.
- Bowles, M. & Wilson P. (2010). The Impact of the Digital Economy and the NBN on skills. Innovation and Business Skills Australia: Melbourne.
- Choi, C. & Yi, M.H. (2009). The effect of the Internet on economic growth: Evidence from cross-country panel data. *Economics Letters*, 105(1), 39-41. <https://doi.org/10.1016/j.econlet.2009.03.028>
- Demetriades, P. & Fielding, D. (2012). Information, institutions, and banking sector development in West Africa. *Economic Inquiry*, 50(3), 739-753. <https://dx.doi.org/10.1111/j.1465-7295.2011.00376.x>.
- Doong, S. & Ho, S. (2012). The impact of ICT development on the global digital divide. *Electronic Commerce Research Applications*, 11(5), 518-533. <http://doi:10.1016/j.elerap.2012.02.002>
- Dwivedi, Y.K., Alsudairi, M.A., & Irani, Z. (2010). Explaining factors influencing the consumer adoption of broadband. *International Journal of Business Information Systems*, 5(4), 393-417. <https://ideas.repec.org/a/ids/ijbisy/v5y2010i4p393-417.html>
- Elgin, C. (2013). Internet Usage and the shadow economy: Evidence from panel data. *Economic Systems*, 37(1), 111-121. <http://doi:10.1016/j.ecosys.2012.08.005>
- Holt, L. & Jamison, M. (2009). Broadband and contributions to economic growth: Lessons from the US experience. *Telecommunications Policy*, 33, 575-581. <http://www.sciencedirect.com/science/article/pii/S0308596109000962>
- Im, K.S., Pesaran, M.H. & Shin, Y. (2003). Testing for unit roots in heterogeneous panels. *Journal of econometrics*, 115(1), 53-74. [http://www.sciencedirect.com/science/article/pii/S03044076\(03\)00092-7](http://www.sciencedirect.com/science/article/pii/S03044076(03)00092-7)
- Johansen, S. (1988). Statistical analysis of cointegration vectors. *Journal of economic dynamics and control*, 12(2-3), 231-254. [http://www.sciencedirect.com/science/article/pii/0165-1889\(88\)90041-3](http://www.sciencedirect.com/science/article/pii/0165-1889(88)90041-3)
- Kao, C. (1999). Spurious regression and residual-based tests for cointegration in panel data. *Journal of econometrics*, 90(1), 1-44. [https://doi.org/10.1016/S0304-4076\(98\)00023-2](https://doi.org/10.1016/S0304-4076(98)00023-2)
- Kelly, T., Liaplina, A., Tan, S., & Winkler, H. (2017). *Reaping Digital Dividends: Leveraging the Internet for Development in Europe and Central Asia*. <https://doi.org/10.1596/978-1-4648-1025-1>
- Levin, A., Lin, C-F., & Chu, C-S. (2002). Unit root tests in panel data: asymptotic and finite-sample properties. *Journal of econometrics*, 108(1), 1-24. <https://ideas.repec.org/a/eee/econom/v108y2002i1p1-24.html>
- Maddala, G.S. & Kim, I.-M. (1998). Unit roots, cointegration, and structural change. Cambridge: Cambridge University Press.
- Maddala, G.S. & Wu, S. (1999). A comparative study of unit root tests with panel data and a new simple test. *Oxford Bulletin of Economics and statistics*, 61(S1), 631-652. <http://dx.doi.org/10.1111/1468-0084.61.s1.13>
- Noh, Y. H. & Yoo, K. (2008). Internet, inequality and growth. *Journal of Policy Modeling*, 30(6), 1005-1016. [http://www.sciencedirect.com/science/article/pii/S0161-8938\(07\)00094-4](http://www.sciencedirect.com/science/article/pii/S0161-8938(07)00094-4)
- Pedroni, P. (2004). Panel cointegration: asymptotic and finite sample properties of pooled time series tests with an application to the PPP hypothesis. *Econometric theory*, 20(3), 597-625. <https://web.williams.edu/Economics/wp/pedronipanelcointegration.pdf>
- Shahiduzzaman, Md. & Alam, K. (2013). Information technology and its changing roles to economic growth and productivity in Australia. *Telecommunications Policy*, 38(2), 125-135. <http://dx.doi.org/10.1016/j.telpol.2013.07.003>
- World Bank (2016). *World Development Report 2016: Digital Dividends*. <https://openknowledge.worldbank.org/bitstream/handle/10986/23347/9781464806711.pdf>
- Zhang, T. (2013). Income disparity and digital divide: The Internet Consumption Model and cross-country empirical research. *Telecommunications Policy*, 37(6), 515-529. <http://doi:10.1016/j.telpol.2012.12.011>



Evaluation Study on the Barriers to Success of Technology Business Incubation Programme in Nigeria – The Moderating Role of Government Policy

Nkem O. Obaji¹, Dele Olaolu²

¹Faculty of Management Sciences, National Open University of Nigeria, Abuja, Nigeria

²Faculty of Management and Social Sciences, Baze University, Abuja, Nigeria

Correspondence: Nkem Obaji, Faculty of Management Sciences, National Open University of Nigeria, Abuja, Nigeria, Tel: +2348169119771 -. E-mail: amazonsng@yahoo.com

Abstract

The business incubation model has been embraced by numerous countries of the world since the concept was first conceived and developed in the USA. It has now received much attention among policymakers and academics particularly within the field of entrepreneurship and small business research. Even though the popularity of the programme, so many tenant firms are still closing shops before and after their exit from the incubator. The aim of this study was to explore how government policy moderates the relationship between the individual critical success factors (CSF) and incubator performance. The study adopted the evaluative qualitative case study design. The population of the study consisted of ten surveying stakeholders who were purposively chosen between the stakeholders. The study found the evidence of the moderating role of government policy on the relationship between barriers to success and incubator performance. The study recommended that government should develop a user friendly framework that will ease the difficulties incubators usually encounter in the course of providing resources to the incubatees.

Keywords: Technology Business Incubation, Government Policy, Nigeria

1. Introduction

In the entrepreneurship space, the part played by small businesses has been highlighted in several entrepreneurship studies (e.g., Higgs & Hill 2019; Agwu & Emeti 2013; Alese 2017). In line with this, small and medium enterprises (SMEs) form the driving force of industrial growth and development in the country. The prominence of SMEs in any country is such that it cannot be ignored by the government of that country, particularly in Nigeria. As a result, it has been established that the growth of SMEs presents as one of the bases of economic development in the country. The positive part of SMEs have been discussed in several SMEs studies, however, the challenges confronting SMEs are numerous. Some of the challenges include funding, business support, infrastructure, and government policy.

Business incubation initiative comes in handy to ameliorate the hitches threatening the small businesses. Entrepreneurial speaking, business incubation assists in the establishment of early-stage enterprises as a strategy to also promote systems of economic development (Al-Mubarak, Al-Karaghoul, & Busler, 2010). Business Incubation is defined by the NBIA as "a business support process that accelerates the successful development of start-up and fledgling companies by providing entrepreneurs with an array of targeted resources and services. These services are usually developed or orchestrated by incubator management and offered both in the business incubator and through its network of contacts". The primary aim of business incubator is to assist new businesses succeed and thereby generate wealth and employment opportunities (NBIA; Pena, 2002).

1.1 Problem Statement

The popularity of business incubation initiative is on the increase now especially as most nations globally have seen it as an instrument for economic development. Despite, the rising interest, misperception about the exact attributes of incubator performance still exists. That is, whether business incubators are indeed attaining their purposes and the precise impact it has on enterprises living in incubator facilities. Despite the popularity of the programme, so many tenant firms are still closing shops before and after their exit from the incubator. Therefore, the intention of this study is to qualitatively evaluate and explore how government policy moderates the relationship between the individual critical success factors and incubator performance.

1.2 Objective of the Study

To explore how government policy moderates the relationship between the individual critical success factors (CSF) and incubator performance

2. Literature Review

The business incubation programme is intended to foster nascent enterprises within one to three years in some sort of secluded place. While in this moderated setting, all the much needed sustenance (e.g., training and mentoring) that are needed for the fledgling enterprises to stay alive are given to them so as to make them to thrive. Theodorakopoulos, Kakabadse, and McGowan (2014) remarked that the tangible components of business incubators' assets had been employed to measure performance, conversely, over time, the focus has been geared towards intangible elements and social aspects of business incubation. Similarly, resources can be tangible as well as intangible (Pergelova & Angulo-Ruiz 2014). The strategic emphasis is positioned on the intangible skills and resources of the firm as they are considered to be non-tradable, more difficult to imitate and take time to build internally (Amit & Schoemaker, 1993). The argument for intangible resources such as business support as part of the CSFs may perhaps be that business incubator being service programmes rather than buildings can assist in growing firms, offer mentoring as well as handholding and support to a fledgling business in meeting its objectives; rather than the idea of approaching the business incubator because of physical building.

Secondly, Financial Resources is the next in line for this study. Entrepreneurially speaking, the part played by financial resources cannot be overemphasised. Levitsky (1996) stated that inadequate access to finance or loan had been one of the most prevalent impediments faced by SMEs in both advanced and evolving countries. In view of this, Abdullahi, Tahir, Aliyu, and Abubakar (2015) noted that inadequate funding indicates the key challenges which can considerably exhibit a direct influence on the capability of a business to grow, upgrade its technology, expand its market, promote its management skills, increase productivity. In the Nigerian context, Olutunla (2005) opined that poor financial resources had been found as the principal inhibitors to SMEs development in Nigeria. In the context of business incubation attainment, several authors have mentioned the role of finance in business incubator performance (Pergelova & Angulo-Ruiz, 2014; Somsuk & Laosirihongthong, 2014).

Furthermore, infrastructure is another factor that authors seem to pick as one of the elements related to the incubation process that spur entrepreneurs to come to the business incubator. It perhaps may be one of the key reasons for a number of entrepreneurs to relocate to the incubator. In entrepreneurship development generally, inadequate infrastructural facilities have posed a challenging difficulty to SMEs processes (Ojo, 2006). Abdullahi et al. (2015) mention the hindrance to infrastructure to include inadequate transportation systems, water supply shortage, poor telecommunication systems, and lack of electricity and solid waste management. Similarly,

Osamwonyi and Tafamel (2010) noted that the obstacles to the SMEs performance in Nigeria businesses have made business owners look for an alternative source of infrastructure; which increases the cost of running the fledgling business. In the business incubation study, Chan and Lau (2005) indicated that infrastructure is in essence a very significant element to the firms residing in the incubator. Kumar and Ravindran (2012) also score a high point to infrastructure as an element of effective incubation programme.

Finally, the distinctiveness of government role in virtually all aspects of a national economy is consequent on the fact that government is always a pacesetter in any national activities. Government policy is a well-established element that wields a substantial sway on a range of activities. (e.g. Ashford, 1993; Asiedu, 2006; Guan, Xie, & Zhou, 2015; Ha & Kang, 2015; Yang, 2014). However, Ojo (2006) noted that Government policies and programmes regarding SMEs had been recognised to be inappropriate, inadequate or inconsistent, and this has since prevented the SMEs growth and development. Furthermore, (Onugu, 2005) also expressed that the SMEs sector in Nigeria has not generally been flourishing for the reason of poor execution of some government policies and policy inconsistencies.

In developing countries, evidence abounds that business incubation programme funding basically depends on government (Akcomak, 2009). Therefore, the effect of government policies still overrules its inconsistencies as well as lack of implementation for the reason that, it still sponsor and fund the scheme. On the contrary, a study has shown that government policy inconsistency does not have significant influence on the performance of small and medium manufacturing firms (Bagshaw, 2014). However, there is considerable evidence in incubator performance literature that opine that lack of government policy makes business incubation practice to be ineffective. The reason being that without government effort through policies, the other resources may not be in place.

In sum, CSF associated with government policy may impact on incubator performance in the course of gaining competitive advantage. Business incubation has helped in no small measure in fostering fledgling businesses through the offering of resources. In this study, an evaluation will be made of the role of government policy in the performance of an incubator initiative programme in Nigeria. This will be done in relation to a related inquiry into the critical success factors of the incubation programme in the particular Nigerian context.

3. Research Methods

3.1 Case Study

Case study research has become more popular in scholarly works related to management. Dul and Hak (2008) defined a case study as "a study in which one case (single case study) or a small number of cases (comparative case study) are selected in their real-world context, and scores obtained from these cases are analysed in a qualitative manner." It is a technique prevalently applied in clinical research where every patient represents a unique case study. Its key goal is to collect all-encompassing, organised, and in-depth information about each case of interest (Patton, 2002). Case studies combine data collection methods such as archives, interviews, questionnaire and observation (Eisenhardt, 1989). Accordingly, the evidence may be qualitative, quantitative or both. As this research strived to find out the challenges concerning SME development through the incubator, the case study method was appropriate.

Furthermore, Yin (2012) suggested that the case study approach be adopted in this kind of research because it is recognised as among the many ways of conducting social science investigation. Dana and Dana (2005) opined that some other methods are historical analysis, surveys, experiments, observation, and the analysis of archival documents. Yin (2009), postulate that each of this technique has its unique advantages, bearing in mind three conditions: (a) the kind of research question, (b) the control the researcher has over real behavioural activity, (c) the focus on present instead of historical event.

3.2 Sample Composition

The ten participants met the selection criteria and willingly agreed to participate in the study. The interviews were all conducted at a time and place convenient to the respondents. The longest interview lasted for 55 minutes while

the shortest interview lasted for 38 minutes. The average time for the interviews was one hour and three minutes. Table 4.1 below gives a depiction of the respondents' details. The youngest respondent was 38 years old, and the oldest was 53 years old. The average age of the respondents was 44.7.

Table 3.1: Participants demographics

No	Code	Gender	Position	Year of Experience	Qualification	Age
1.	IM1	Female	Incubator Manager	13	Ph.D.	48
2.	IM2	Male	Incubator Manager	8	Masters	43
3.	IM3	Male	Incubator Manager	10	Masters	44
4.	IM4	Female	Incubator Manager	7	Masters	43
5.	IM5	Male	Incubator Manager	5	Masters	37
6.	IT1	Male	Incubator Tenant	2	Vocational Training	42
7.	IT2	Male	Incubator Tenant	2	Diploma	49
8.	IT3	Female	Incubator Tenant	1	Vocational Training	38
9.	IT4	Male	Incubator Tenant	3	Vocational Training	39
10.	IT5	Male	Incubator Tenant	2	Diploma	36

3.2 Interview Analysis

This study's qualitative data was analysed employing inductive analysis as well as a particular method from the constant comparison technique were also utilised in performing the analysis (Yin, 2009) of the involvement of technology incubation managers and tenant business owners. Krathwohl (1998) posits that the constant comparative method encompasses the researcher in carrying out data analysis from the interview commencement. Yin (2012) added that initial data is coded to show the concept or dimension it represents, and the researcher connects concepts together into a theory, or explanation of the phenomenon studied. Qualitative data analyses entail comprehending the extent of making text and images meaningful in order to allow researcher to form responses to his research questions.

Creswell (2012) mentioned the six steps used in analyzing and interpreting the qualitative data. These steps are not always taken in sequence, but they represent preparing and organising the data for analysis; engaging in an initial exploration of the data through the process of coding it; using the codes to develop a more general picture of the data - descriptions and themes; representing the findings through narratives and visuals, making an interpretative meanings of the results and connecting the findings to the literature with the aim of validating the research findings. However, qualitative research is an iterative phase-like, meaning that you cycle back and forth between data collection and analysis by going back to your respondents to collect more information to fill in gaps in their stories as your analysis proceeds. Also it involves reading through the data several times and conducting an analysis each time. Each time you read your database you develop a deeper understanding about the information supplied by your respondents. Creswell (2012) indicated that several approaches are available to analysing qualitative data, although several guidelines exist for this process (see Miles & Huberman, 1994; Miles, Huberman, & Saldaña, 2014).

3.3 Manual Analysis

Despite the fact that the utilization of computer software for different goals is in recent past exceptionally well known, scholars still have an alternative to make about whether to do data analysis manually or employ software (Creswell, 2012; Miles & Huberman, 1994; Tesch, 1990). The employment of manual qualitative data analysis implies that researchers read the data, mark it by hand, and partition into parts. Generally, text data analysis includes utilizing colour coding to check parts of the text or cutting and pasting text sentences onto cards (Creswell, 2012). Evidence has shown that many researchers are comfortable with the manual approach to qualitative data analysis (Ajagbe, 2014; Ajagbe & Ismail, 2014). After the researcher has arranged and transcribed the data and made a decision on whether to analyse the data manually. This study finally settled for manual data analysis in view of the reasons expressed by past authors which were relied upon as a justification for manual analysis (Creswell, 2012; Miles & Huberman, 1994; Tesch, 1990).

3.4 The Interview

For the reason that the data collected take the form of recorded interviews, hence it was only possible to analyse them in its transcribed form. Thus all recorded interviews were transcribed by the researcher. After data collection, the researcher was faced with a huge amount of data. For the sake of organising the data, the literature was further reviewed and the data was summarised as suggested by Yang (2008). The transcribed interviews data, were coded. The coding which loosely adopted the Strauss and Corbin (1990) recommendation, detached segments of data on the basis of responses to related questions. As the open ended questions probed during the interview procedure were generally alike for all respondents, answers were similar enough in many cases to draw comparisons based on the responses generated by the respondents. The research did not take a look at word level analysis, as one of the predominant assumptions of the study has been the acceptance of answers. The study assumed that participants answered in an honest and realistic fashion. Through the process of constantly comparing data as well as categorization, during and after the data collection period; themes of major concern emerged from the data. Themes build upon each other to create a better understanding of the challenges faced by technology incubation programme in Nigeria from the perspective of incubation managers and tenants.

Table 4.1 shows the taxonomy of the barriers of technology incubation programme in Nigeria as grounded in the interview transcript.

Table 4.1: Taxonomy of the Barriers of TBI in Nigeria

Research Question	Main Themes	Sub-Themes
How do the barriers to success of Technology Business Incubation affect its performance in Nigeria?	Inadequate Funding	Low entrepreneurship development
	Inadequate Infrastructure	Low job creation
	Inadequate Business Support	Programme failure
		Business collapse
		Inconsistent polices
	Inconsistent Government Policy	Production reduction
		Inadequate infrastructural capability from the incubator management

4. Effect of the barriers to Technology Incubation Programme in Nigeria

4.1 Discussion of Themes

a) Inconsistent government Policy

The archetypal idea of the technology business incubation programme in Nigeria was to cause the transformation of research and development (R&D) results into products and services in the Nigerian economy. This has since been disrupted due to the shortage of research amenities in Nigeria and discrepancies in the way government

executes its policies. There are many laudable government policies from different regimes however, the application and uniformity towards the implementation of the initiative have been the despair of national industrialisation. Government each time puts forward one policy document or the other from time to time with different nomenclature but with the same intents and purposes as well as diverse procedures. The consequence of this is that so many initiatives that have laudable plans to be thrown away just for its successor to be doing the same thing with a different name and with different workforce. This has not indeed assisted the country in accomplishing the anticipated success in all these programmes comprising SMEs generally and technology incubation to be specific, as a result of changes and inconsistencies in the workforce as well as different objectives and perspectives of the plan.

The qualitative result shows that government policy can make or mar business incubation programme in Nigeria. Therefore, government policy has high importance attached to it. In line with this, if government want to move a particular sector of the economy forward, what it needs to do, is just to roll out policy document to that effect. Its role in business incubation is outstanding. Thus the study on government policy is consistent with (Greene, 2012; Mason & Brown, 2011; Minniti, 2008).

Furthermore, as policies make available strategic direction for any given programme of the government, unsuitable policy direction has been the weak spot for the technology incubation programme in Nigeria; it plans a course for the tactical and operational delivery of the initiative. Wrong policy direction has been a major obstacle affecting the effective provision of the technology incubation programme in Nigeria. This is deep-rooted by the absence of a national plan on the technology incubation programme. There is little or no reference of the technology incubation programme on the National Development Plan even in the existing Vision 20-20-20.

For the reason that a visible insight of the origin and crux of the programme will decide the policy direction and the modus operandi; whereas, a poor understanding will constantly cause an incongruity and misunderstanding with its associated consequence on application. However, all these can only be achieved through clear policy direction and complete manifestation of the technology business incubation programme. It is indeed high time the Technology Business Incubation in Nigeria is understood, practiced and implemented in the right fashion for the benefit of the Nigerian Economy and this can only be achieved through a sound policy direction.

Government policy is a very important aspect of entrepreneurship development and as such, can determine the success or failure of entrepreneurship development generally and business incubation programme to be specific. However, the success still depends on which side of the divides government leans

Funding

For the attainment of technology business incubation scheme, there should be a funding pattern by which the initiative will be constantly funded. The programme should be funded based on the policy document establishing the TI concept. The TBI funding stream should as a matter of urgency be multifaceted in operation. The Federal government that established the scheme should define the role played by each stakeholder in the scheme.

The basis for beginning technology incubation centres is to encourage the development of new businesses and greenhorn enterprises that have sufficient technology input and output. Therefore, it is necessitated to provide financial resources to the incubator in such a way as to make funding accessible to the entrepreneurs; unfortunately, incubators cannot on their own provide funds for the tenants. The reason is that the incubators are not making money on their own; they still depend on government subvention for their sustainability and as such cannot provide any financial assistance directly to the incubator tenants. This has made activities at the technology incubation centres very challenging to the point that the incubator management cannot render the rudimentary function put on the incubator. As the incubator cannot help the tenant firms directly, the incubator management usually attracts the other sources of funding for the tenants, for instance banks, venture capitalist, angel organization.

With regards to commercial banks, the entrepreneurs are discouraged by the stiff collateral imposed by banks which makes it difficult for them to be offered a loan facility. Concerning the venture capitalists, the TI programme lacks the venture capitalists that would ordinarily come in to help out; unfortunately, they seldom exist and if they

do exist, the venture capitalists would seldom invest in the newly-formed business enterprises. Also, angel organisations that are private high net-worth individuals would be skeptical about taking up some equity investment in the newly formed businesses.

Funding is almost like the backbone of any organisation, be it social organisation or business organisation. The impact of financial in any of these organisations is overwhelming. Finance play a very big role in entrepreneurship generally and TBI in particular. The reason being that without funds, the much needed facilities would not be available.

Business Support

The construct BS, the management assistance services used by the incubator management to provide the needs of the incubatees were investigated. By so doing, the study participants were requested to share their view points of how the barriers to the challenges incubation programme face affect the performance of the programme in Nigeria. The question investigates the attached to business support in contributing to the overall incubation performance. All the respondents acknowledged that BS is so important to the overall performance of the programme, while its absence or lack will portend doom for the programme. Majority of the respondents in the tenant firm category affirmed that the business incubator in which they operate are not really given them the much needed management assistance.

It has been noted that the reason associated with small business failure is because of the inadequate training or mentoring. Most small businesses at the beginning of their entrepreneurial life, more often than not lack the basic knowledge of business development, and other business support. Against this backdrop, business incubators usually make available all these cited business support services. It is assumed that business support is an important element for the attainment for small firms. The bottom line of business enterprises approaching the incubator is to acquire a number of those resources that enterprises cannot come up with. Consequently the coming of new start-ups to the incubators is to have access to these resources. Prior scholarly works have admitted the rationale for business support by incubators owing to the fact that a most of fledgling businesses do not have the required resources or critical capabilities for business success (Scarborough & Zimmerer, 2000; Shepherd & Shanley, 1998)

Similarly Business support or management assistance service is deemed an essential part of the incubation programme without which the fledgling businesses will not be nurtured. Without the nurturing of greenhorn businesses, there would not be the establishment of business incubators for the reason that the small inexperienced firms are the direct beneficiary of the programme.

Infrastructure

In the business incubation programme, the role of infrastructure is very significant due to the fact that most of the entrepreneurs who later came to the incubators did so for motive of the facilities which they cannot afford in their former place of work. Adequate infrastructure stemming from the sizable incubation unit, available ready-made alternative source of electric power vis-à-vis transformers as well as generators, water reticulation incubation unit, telecom facilities as well as road network within the incubation unit. On the converse, dearth of these infrastructures obviously impinges on the performance of the incubatees themselves who obviously rely on these facilities to be able to nurture their small businesses which are actually kept in incubation centre to be housed in an environment where they source infrastructure at low or no cost. When these infrastructures are not available, the incubatees will resort to the same little facilities they came to source in the first place. In a situation whereby there is inadequate or absence of infrastructures, incubation programme is often rendered redundant; thus entrepreneurship development will be affected. In view of this, a centre manager reiterated the need for adequate infrastructure across the incubation centres in the country.

5. Discussion on Findings

The findings of this evaluative qualitative study gives high importance to the role of government policy in harmonizing other elements of business incubation programme. As noted in the literature review that government is always in the lead of all entrepreneurship development and support. Despite the salient role of government

policy, respondents still take a swipe at the inconsistency of government policies. But overall, the importance of government policy cannot be overemphasised. Furthermore, consistent with the view that government policy is an important intangible resource that can enhance entrepreneurship by making a favourable environment for assisting the entrepreneurs in the incubators. It also strengthens the influence of business support and incubator performance relationship. In particular, there was a stronger relationship between business support and incubator performance with high government policy as opposed to low government policy. It can be concluded that favourable government policy is an essential condition for the performance of TBI programme. An entrepreneurial focused government policy will cause the sustenance and thriving of business incubation performance. This research suggests that government policy acted as a booster between business support and incubator performance, such that where there is high government policy or favourable government policy, there is likelihood for the performance of the incubator to increase. In other words, this finding suggests that when there is entrepreneurial friendly policy, there is likelihood of entrepreneurship through business incubator to get superior performance. The results provide support for the view that government policy moderates the relationship between business support and incubator performance. These findings are not surprising because they are consistent with Mohd Shariff, Peou and Ali. (2010). In addition, the study found government policy to moderate the relationship between financial resources and infrastructure respectively and incubator performance.

6. Conclusion and Recommendation

In conclusion, this study has shown that favourable government policy is an essential condition for the performance of Technology Business Incubation programme in Nigeria. Both the literature review and the empirical findings have shown how important government policy means to the development and performance of incubation programme.

On the basis of the findings of the empirical study, the researcher made several recommendations to guide business incubator managers and incubatees as well as government to enhance the creation of incubation programmes in Nigeria. The results of this study show that government policy influences the operations and practice of technology incubation programme. Government should as a matter of urgency develop a user friendly framework that will ease the difficulties incubators usually encounter in the course of providing resources to the incubatees. Government should begin to work towards developing incubation strategies that will contribute to the improvement of the programme, which will in turn will positively influence the performance of incubators.

References

- Abdullahi, M. S., Tahir, I. M., Aliyu, R. L., & Abubakar, A. (2015). Strengthening Small and Medium Scale Enterprises (SMEs) For Poverty Alleviation in Nigeria. *IOSR Journal of Humanities and Social Science (IOSR-JHSS)*, Volume 20 (6), 101-110.
- Agwu, M. O., & Emeti, C. I. (2014). Issues, challenges and prospects of small and medium scale enterprises (SMEs) in Port-Harcourt city. *European Journal of Sustainable Development*, 3(1), 101-114.
- Ajagbe, A. M. (2014). Funding Criteria in Technology Based Firms. *Universiti Teknologi Malaysia*.
- Ajagbe, M. A., & Ismail, K. (2014). Factors influencing venture capital assessment of high growth companies in Malaysia. *International Journal of Entrepreneurship and Small Business*, 21(4), 457-494.
- Akcomak, I. (2009). Incubators as Tools for Entrepreneurship Promotion in Developing Countries. Research paper No. 2009/52 in UNU-WIDER.
- Alese, O. J. (2017). Strategic management and the development of small and medium enterprises in south-west, Nigeria. An unpublished PhD Thesis of Olabisi Onabanjo University, Ogun state, Nigeria.
- Al-Mubarak, H., Al-Karaghoul, W., & Busler, M. (2010). The Creation of Business Incubators in Supporting Economic Developments. Paper presented at the European, Mediterranean & Middle Eastern Conference on Information Systems 2010 (EMCIS2010).
- Amit, R., & Schoemaker, P. J. (1993). Strategic assets and organizational rent. *Strategic Management Journal*, 14(1), 33-46.
- Ashford, N. A. (1993). Understanding technological responses of industrial firms to environmental problems: Implications for government policy. Paper presented at the Environmental strategies for industry: International perspectives on research needs and policy implications.

- Asiedu, E. (2006). Foreign direct investment in Africa: The role of natural resources, market size, government policy, institutions and political instability. *The World Economy*, 29(1), 63-77.
- Bagshaw, K. B. (2014). Power Supply Infrastructure and Government Policy Inconsistency on The Performance of Small and Medium Scale Manufacturing Firms In Nigeria: An Empirical Assessment. *AIJCSR*, 1(2).
- Chan, K., & Lau, T. (2005). Assessing technology incubator programs in the science park: the good, the bad and the ugly. *Technovation*, 25(10), 1215-1228.
- Creswell, J. W. (2012). *Educational research: Planning, conducting, and evaluating quantitative and qualitative research* (4 ed.). London: Pearson.
- Dana, L. P., & Dana, T. E. (2005). Expanding the scope of methodologies used in entrepreneurship research. *International Journal of Entrepreneurship and Small Business*, 2(1), 79-88.
- Dul, J., & Hak, T. (2008). *Case study methodology in business research*: Routledge.
- Eisenhardt, K. M. (1989). Building theories from case study research. *Academy of management review*, 14(4), 532-550.
- Greene, F. (2012). Should the focus of publicly provided small business assistance be on start-ups or growth businesses? (No. 12/2). Ministry of Economic Development, New Zealand.
- Guan, Q., Xie, X., & Zhou, J. (2015). The Influence of Government Policy on University Technology Transfer in China LISS 2013 (pp. 439-443): Springer.
- Ha, E., & Kang, M.-k. (2015). Government Policy Responses to Financial Crises: Identifying Patterns and Policy Origins in Developing Countries. *World Development*, 68, 264-281.
- Higgs, C. J., & Hill, T. (2019). The role that small and medium-sized enterprises play in sustainable development and the green economy in the waste sector, South Africa. *Business Strategy & Development*, 2(1), 25-31.
- Krathwohl, D. R. (1998). *Methods of educational and social science research: An integrated approach*: Longman/Addison Wesley Longman.
- Kumar, K. S., & Ravindran, D. S. R. (2012). A Study on Elements of Key Success Factors Determining the Performance of Incubators. *European Journal of Social Sciences*, 28(1), 13-23.
- Levitsky, J. (1996). *Support systems for SMEs in developing countries Small and Medium Enterprises Programme Vienna*: United Nations Industrial Development Organization.
- Mason, C., & Brown, R. (2011). Creating good public policy to support high-growth firms. *Small Business Economics*, 40(2), 211-225.
- Miles, M. B., & Huberman, A. M. (1994). *Qualitative data analysis: An expanded sourcebook* (2nd ed.). London: Sage Publications.
- Miles, M. B., Huberman, A. M., & Saldaña, J. (2014). *Qualitative data analysis: A methods sourcebook*: SAGE Publications, Incorporated.
- Minniti, M. (2008). The role of government policy on entrepreneurial activity: productive, unproductive, or destructive? *Entrepreneurship Theory and Practice*, 32(5), 779-790.
- Mohd Shariff, M. N., Peou, C. and Ali, J. (2010). Moderating effect of government policy on entrepreneurship and growth performance of small-medium enterprises in Cambodia. *International Journal of Business and Management*, 3(1), 57.
- NBIA. NBIA Publications Retrieved from <http://www.nbia.org>.
- Ojo, A. T. (2006). Using SMEs to Achieve Millennium Development Goals: Challenges and Prospects. *Covenant Journal of Business and Social Sciences*, 1(1), 20-35.
- Olutunla, G. T. (2005, July 7, 2008). Implementation of the small and medium industries equity investment scheme in Nigeria. Retrieved from <http://www.sbaer.uca.edu/research/icsb/2005/153.pdf>
- Onugu, B. A. N. (2005). *Small and medium enterprises (SMEs) in Nigeria: Problems and prospects*. St. Clements University, Nigeria (Unpublished Dissertation for a Doctor of Philosophy in Management Award).
- Osamwonyi, I. O., & Tafamel, A. E. (2010). Options for sustaining small and medium scale enterprises in Nigeria: Emphasis on Edo state. *African Research Review*, 4(3b).
- Patton, M. (2002). *Qualitative research & evaluation methods* (3rd Ed.). CA: Thousand Oaks, Sage.
- Pena, I. (2002). Intellectual capital and business start-up success. *Journal of intellectual capital*, 3(2), 180-198.
- Pergelova, A., & Angulo-Ruiz, F. (2014). The impact of government financial support on the performance of new firms: the role of competitive advantage as an intermediate outcome. *Entrepreneurship & Regional Development* (ahead-of-print), 1-43.
- Scarborough, N., & Zimmerer, T. (2000). *Effective Small Business Management: An Entrepreneurial Approach* (Vol. sixth). Upper Saddle River, New Jersey: Prentice-Hall.
- Shepherd, D. A., & Shanley, M. (1998). *New venture strategy: Timing, environmental uncertainty and performance*: SAGE Publications, Incorporated.
- Somsuk, N., & Laosirihongthong, T. (2014). A fuzzy AHP to prioritize enabling factors for strategic management of university business incubators: resource-based view. *Technological Forecasting and Social Change*, 85, 198-210.

- Strauss, A., & Corbin, J. M. (1990). *Basics of qualitative research: Grounded theory procedures and techniques*. Newbury Park: Sage Publications, Inc.
- Tesch, R. (1990). *Qualitative research: Analysis types and software tools*. Bristol, PA: Falmer Press.
- Theodorakopoulos, N., K. Kakabadse, N., & McGowan, C. (2014). What matters in business incubation? A literature review and a suggestion for situated theorising. *Journal of Small Business and Enterprise Development*, 21(4), 602-622.
- Yang, C. (2014). Government policy change and evolution of regional innovation systems in China: evidence from strategic emerging industries in Shenzhen. *Environment and Planning C: Government and Policy*, 32, 000-000.
- Yang, K. (2008). *Voice of the customer capture and analysis*. New York: McGraw Hill.
- Yin, R. K. (2009). *Case study research: Design and methods* (4th ed.). California: Sage publications.
- Yin, R. K. (2012). *Applications of case study research*: Sage Publication.



Empirical Testing of the Five-Factor Model of Fama and French in Indonesia as an Emerging Capital Market

Mustaruddin Saleh¹

¹Department of Management, Faculty of Economics and Business, Tanjungpura University, PONTIANAK.
Email: mustaruddin@gmail.com

Abstract

This study was conducted to empirically examine the five-factor model of Fama and French in respect to stock returns of companies listed in the finance sector with 170 observations over the period 2012-2016. As a comparative analysis, this study is also conducted to examine CAPM and the three-factor model of Fama and French. The findings of the study revealed that the market return has a positive and partially significant impact on the stock return for CAPM. Specifically, both variables, small minus big (SMB) and high minus low (HML) have a positive and significant impact on stock returns in the three-factor model and five-factor model of Fama and French. In contrast to the research of Fama and French the explanation power of the five-factor model is lower than that of the three-factor model in this research.

Keywords: CAPM, Three-Factor Model, Five-Factor Model, Stock Returns

JEL Classifications: G3, G11

1. Introduction

In an effort to minimize the investment risk faced by investors for each investment portfolio, various theoretical models have been developed to explain the relationship between risk and return. The first model introduced was the capital asset pricing model (CAPM). This model is based on the portfolio theory proposed by Markowitz, where each investor is assumed to diversify their portfolio and choose the optimal portfolio on the basis of their preference for the level of profit and risk. The CAPM was first introduced by Sharpa (1964), Litner (1965), and Mossin (1966) in the mid-1960s; the model was very popular, and many empirical studies were carried out. The results of many empirical studies support the CAPM. Some empirical results include the studies of Black, Jensen, and Scholes (1972), and Fama and MacBeth (1973). Black et al. (1972), who tested the CAPM using time series data and cross-sectional data, found a positive relationship between beta and excess return. Fama and MacBeth (1973) provided support for the previous study by confirming that there is a positive and significant relationship between beta and excess return.

However, other empirical tests revealed that investment risk cannot be determined by a single factor (beta). As the research conducted by Fama and French (1992), Asgharian and Hansson (1998), Hodhosima et al. (2004), and Sandoval and Saens (2004) stated that there is no significant effect between beta stocks and stock returns, this researcher concluded that other variables are needed as additional variables to explain the relationship between

risk and return. Thus, anomalies occur from the results of empirical testing of the CAPM. This is confirmed by the results of empirical studies that found that there is special volatility (Ang, Hodrick, Xing, and Zhang, 2006), liquidity risk (Pastor and Stambaugh, 2003), and momentum. As the results of the empirical studies above found that market beta is not able to explain the relationship between the rate of return and the risk of a securities portfolio, a multi-factor model was developed. This model, called the arbitrage pricing theory (APT) (Ross, 1976), stated that the return expectation of stocks might be influenced by several other sources of risk. This model is more efficient than the CAPM, and has been used extensively (Sudiyatno and Irsad (2011)). The research of Fama and French (1996) revealed that the book-to-market ratio, firm size, and market return affect stock returns. This model became known as the three-factor model of Fama and French. Furthermore, empirical testing using three factors has been widely used in capital markets in developed countries as well as developing countries. In 2000, Davis, Fama and French (2000) re-tested the three-factor model, and found that beta, size, and book-to-market ratio had a significant influence on stock returns (Bodie et al., 2005). Other empirical studies that also used this model, found varied results, with not all factors being able to consistently explain stock returns; for example, beta had no significant effect, and firm-size and book-to-market ratio had a significant effect in China (Drew et al., (2003)). Naughton and Veeraraghnavan's research found that only beta influenced and significantly affected stock returns in the three countries tested; namely, Indonesia, Taiwan, and Singapore (2005), while Charitou and Constantinidis (2007) found that the three variables, namely beta, firm size and book-to-market ratio had a significant effect on stock returns in the Japanese market.

The latest development is that Fama and French (2015) proposed two additional variables to their previous model; namely, the profitability variable and the investment patterns variable. Hence, the new model is called the five-factor model of Fama and French. This model tries to explain the relationship between these new variables with the stock returns expected using the discounted dividend model perspective and valuation theory. Empirical testing of this five-factor model has been tried by Nguyen et al. (2015) in the capital market in Vietnam. The results of their study showed that there were quite high anomalies compared to the traditional asset valuation models; namely, CAPM and the three-factor model of Fama and French (1993). Nguyen et al. found that entering variable profitability and investment factors, showed superior results compared to the CAPM and three-factor model of Fama and French. This study conducts an empirical study of the five-factor model of Fama and French (2015) on Indonesia's Stock Exchange, where, to the author's knowledge, there has been limited empirical testing. This is understandable because the five-factor model was only recently published by the researchers. This research is deemed necessary as a contribution to the empirical testing of asset valuation models using the five-factor model of Fama and French.

Based on the background described, the formulation of the problem in this study is as follows: (1). Can the variation in the rate of return of shares on Indonesia's Stock Exchange be explained by CAPM? (2). Can the variation in returns on shares on Indonesia's Stock Exchange be explained using the three-factor model of Fama and French? (3). Can the variation in the rate of return of shares on Indonesia's Stock Exchange be explained using the five-factor model of Fama and French?

2. Literature Review

The investment goal for every investor is to maximize returns, without forgetting the investment risk factors that must be faced. Return is one of the factors that motivates investors to invest and is also a reward for the courage of investors to bear the risk of the investment made. According to Eilly and Brown (2004: 4) investors invest funds from their savings and delay consumption to get a return on their investment. Investors will choose stocks that produce high returns with a high level of risk, and vice versa, stocks with low returns will have a lower risk.

1.1. Single Index Model

The single index model was developed by William Sharpe (1964), Lintner (1965), and Mossin (1966). According to Hartono (2014: 407) "a single index model is based on the observation that the price of a security fluctuates in the direction of the market price index." Stock prices tend to increase when the market price index increases, and vice versa. This shows that the profit level of a stock has a correlation with market changes (Husnan, 2001: 103).

The single index model uses beta in measuring the sensitivity of the level of profit of a security against the level of profit from the market (Hartono, 2014: 409). The bigger the beta of a stock, the greater the market risk.

The capital asset pricing model (CAPM) is a model that shows the relationship between the expected profit and the risk of a stock or portfolio as measured by beta. The advantage expected by investors is based on two things; namely, compensation from the time value of money and risk premiums (Breadley et al., 2007). So, the expected level of profit from a security in the CAPM model is the return of risk-free assets as compensation for the time value of money plus risk premiums or additional implied profits based on the systematic risk of a security. The CAPM is based on the portfolio theory built by Markowitz, which is based on the assumption that each investor will diversify their portfolio and choose the optimal portfolio according to their preference for return and risk.

1.2. Three-Factor Model of Fama and French

The findings from the results of empirical studies reveal that there are contradictory results from the CAPM. The results of the study question the accuracy of the CAPM, which considers that beta is the only variable that explains the expected stock return. The previous studies found that deviations from risk, as measured by beta with stock returns, were also influenced by other variables. These variables are firm size (Banz, 1981), company profits (Basu, 1997 and 1983), leverage (Bhandari, 1988), and the book value to market value ratio (B/M) (Stattman, 1980, Rosenberg et al., 1985; Chan et al., 1991). The results of the studies proved that there is a positive relationship between earnings, cash flow, and B/M ratio with stock returns, and a negative relationship between company size and stock returns.

The research of Fama and French (1992, 1993) showed that company size and the B/M ratio have an important role in explaining the difference in the expected rate of return on cross-sectional non-financial companies. Furthermore, Barber and Lyon (1997) found that the relationship between size, B/M ratio, and rate of return is the same for financial and non-financial companies. They recommended an alternative model. The evidence suggests that the proxy size of the company and the B/M ratio for the sensitivity of risk factors in the rate of return is consistent with rational-pricing for the role of company size in the average rate of return. The size of the company can be a proxy for the risk of negligence and B/M can be an indicator of the relative prospects of the company (Pasaribu, 2009). Cochrane (1996 and 2001) stated that the asset pricing models that use portfolio returns as a factor may be able to explain asset return rates adequately; however, they have only been able to explain these factors partially because this model still leaves unanswered questions regarding returns based on factors (Pasaribu, 2009). Company size and B/M ratio are variables outside the CAPM, and research uses them as additional variables to clarify the relationship between risk and return in the CAPM. The results of the study conducted by Fama and French (1992) revealed that the B/M ratio and company size have a strong influence on the average return on shares. So, by entering the variable company size and B/M ratio into the model, the model is known as the three-factor model of Fama and French (1996).

1.3. Five-Factor Model of Fama and French

Criticism of the CAPM through the use of strict assumptions has led to this model being rejected and difficulty in applying it in real conditions. However, without ignoring the large contribution of the model in financial research, several other models have been developed to strengthen the explanation between risk and the rate of return on securities. Among them are the introduction of the many factor model from Ross (1976), which is popular with the term arbitrage pricing theory (APT). However, the weakness of APT is that it cannot provide guidance concerning what factors are relevant in influencing the returns on a stock. Then a three-factor model was developed by Fama and French (1992), which added to the CAPM model by including the variable size of the company and the B/M ratio, thereby becoming a model of three factors – market returns, company size, and B/M ratio. Furthermore, Carhart (1997) further examined the Fama and French three-factor model by including the variable impact of stock performance in the past on stock performance in the future, which became known as the four-factor model. Carhart's model (1997) includes four variables in the model, market risk premium factors, firm size, B/M and momentum ratio, and winner minus loser (WML). His research findings stated that the four-factor model

can explain variations in portfolio returns based on past rates of return, and is consistent with the market model with four risk factors.

Multi-factor studies continue to be carried out by financial researchers, and the latest Fama and French (2015) research added two new variables to the three-factor model; namely, profitability and investment patterns. The two variables included were based on the results of various empirical studies that found that these two factors contributed to and affected asset returns (Hou, Xue, and Zhang, 2014; Novy-Max, 2013; and Titman et al., 2004). This model is known as the five-factor model of Fama and French. The results of the study by Fama and French (2015a and 2015b) showed that the ratio variable B/M places more emphasis on the explanation of the stock returns in the five-factor model. However, when testing on the international market, Fama and French (2015b) found that the five-factor model was more suitable for the North American and European markets and for large stock shares. Their findings also stated that there is a weak relationship for the rate of return of shares in the Japanese market. An empirical study with a five-factor model in emerging markets has been carried out by Nguyen et al. (2015) in the Vietnamese capital market. Their study found that the Fama and French five-factor model was better at explaining stock returns compared to the traditional CAPM model and the three-factor model. To the author's knowledge, no one has used the five-factor model of Fama and French for empirical studies in the Indonesian capital market. For this reason, this research is conducted to find empirical evidence to determine whether the new model provides a better explanation than the previous models.

2. Research Method

The population in this study is public companies listed in the Financial Sector of Indonesia's Stock Exchange for a period of 5 years from 2012 to 2016. The research samples were taken by purposive sampling. In the estimation method the regression model using panel data can be done through three tests; to compare the performance of the CAPM with the three-factor model of Fama and French, and the five-factor model from Fama and French. This method can use the ordinary least squares (OLS) approach or the least squares technique to estimate the panel data model. The regression equation can be written as follows:

$$\text{Single Index Model: } R_{i,t} = \alpha + \beta_i R_{m,t} + e_{i,t} \quad (1)$$

$$\text{Three-Factor Model: } R_{i,t} = \alpha + \beta_i R_{m,t} + \beta_i \text{SMB}_t + \beta_i \text{HML}_t + e_{i,t} \quad (2)$$

$$\text{Five-Factor Model: } R_{i,t} = \alpha + \beta_i R_{m,t} + \beta_i \text{SMB}_t + \beta_i \text{HML}_t + \beta_i \text{PF}_{i,t} + \beta_i \text{INVESTI}_{i,t} + e_{i,t} \quad (3)$$

Where:

$R_{i,t}$ = portfolio return in period t

$R_{m,t}$ = market return, shows the JCI return, calculated from the stock price index with (IHSG) period t , minus IHSG $t-1$ return.

$\text{SMB}_{i,t}$ = return on the factor "small minus big (SMB) in period t

$\text{HML}_{i,t}$ = return on high minus low, book to market period t .

$\text{PF}_{i,t}$ = return on the profitability factor, that is, by dividing net income after tax with the book value of shareholders in period t .

$\text{INVEST}_{i,t}$ = return on investment factor, which is calculated from the stock capitalization value circulating, and dividing investors into two groups; namely, the conservative investor group and the aggressive group of investors.

The regression coefficient here is very decisive as a basis for analysis, considering that this research is a fundamental method. This means that if the coefficient β is positive (+), then it can be said that there is a direct influence between the independent variable and the dependent variable. Each increase in the value of the independent variable will result in an increase in the dependent variable. Likewise, vice versa, if the coefficient of the value of β is negative (-), this indicates a negative influence where the increase in the value of the independent variable will result in a decrease in the value of the dependent variable.

This study uses panel data regression analysis, so the selection of estimation models can be done through three approaches: (1) common effect model using the ordinary least squares (OLS) approach or the least-squares technique to estimate the panel data model. (2) the fixed-effect model, which assumes that differences between individuals can be accommodated from the difference in intercepts. This estimation model is often called the least

squares dummy variable (LSDV) technique. (3) The random effect model which estimates panel data where interference variables may be interconnected between time and between individuals. The tests conducted to determine the right model can used a test tool, such as the (1) Lagrange multiplier test to find out whether the random effect model is better than the common effect method. (2) The Chow test or likelihood test for selection between the fixed effect models and common effects. Or (3) the Hausman test to choose whether the fixed effect model or random effect is the most appropriate to use.

3. Results and Discussion

3.1. Descriptive Statistics Analysis

Table 1 shows that the smallest value of the stock return rate, R_i , is 0.0001, while the highest value of R_i , is 0.5301. The average value of R_i is 0.0727, which means that the value that represents the R_i data is 7.27%. The standard deviation of R_i is 9.91%, which indicates that the average deviation of the data from the data on average stock returns is 9,91%. The highest monthly average return rate of 4.64% occurred in 2012. This proves that the economic situation at that time was in a good and stable condition, and, hence, the community could increase consumption and investment, which continued to increase the company's performance. The lowest rate of return of 0.89% occurred in 2013. The low monthly returns during the year were caused by less stable economic conditions, which had an impact on the declining company performance. If viewed per company, for five (5) years, the shares of three companies produced the highest monthly return in a row, these shares were those of PT. Atharvest Tbk, PT. Dayin Mitra Insurance, Tbk, and PT. Asuransi Harta Aman Pratama, Tbk, which were 30.21%, 14.44%, and 14.43%, respectively.

Table 1. Descriptive Statistics

	Minimum	Maximum	Mean	Std Deviation
	Statistic	Statistic	Statistic	Statistic
R_i	0.00010	0.53005	0.072704	0.099167
R_m	0.00030	0.01707	0.009690	0.005392
SMB	0.00100	0.54867	0.079004	0.094417
HML	-7.5100	-0.61000	-3.128500	1.172690
FP	-0.50339	0.50298	0.120973	0.007249
INVST	-0.52112	0.49268	0.029105	0.118912

The market rate of return (R_m) can be defined as the difference between the average of each month of all the shares with the rate of return of risk-free investment (risk-free rate). However, in this study, the market returns use the concept of reality returns, which are calculated based on historical data (Sudiyatno and Irsad, 2011). The lowest market return rate is 0.000030 or 0.03% and the highest is 0.01706 or 1.71%. The development of monthly market returns is volatile and tends to decline. The highest monthly market return occurred in 2014; namely, 1.70% and the lowest occurred in 2015, which was -0.97%. This indicates that Indonesia's economic development in 2015 experienced a relatively significant decline. Judging from the growth of monthly returns, the highest monthly returns for the 5 years study period occurred in February and March, which were 3.63% and 3.38%, respectively.

The results of the SMB descriptive statistics show that the smallest value is 0.0010, while the highest value of SMB is 0.5488. The average value is 0.0790, meaning that the value that represents the data is 7.90%. The standard deviation is 1.17%, which indicates that the average deviation of the data from the average SMB data is 9.44%. The size of the company (firm size) in this study is proxied by SMB (small big minus). SMB is the difference between the average of each month of returns on small stock portfolios or small companies with the average of each month of return on large stock portfolios or big companies. The other variables are presented in table 1.

3.2. Regression Test Result

In order to estimate the model with panel data, this study uses three alternative estimation models; namely, the common effect model (CEM), the fixed effect model (FEM), and the random effect model (REM). The third test results of the regression models used in the research are described in the following.

3.2.1. Regression test model 1: CAPM

The results of the t-test statistics for the CAPM model are shown below. The test results in Table 2 show that the market rate of return (R_m) has an effect on the rate of return of shares in CEM, and has a significant partial effect on FEM and REM. This means that the portfolio returns in this research model can be explained by market returns at a significance level of 10% ($\alpha = 10\%$).

Table 2. Regression Test Result for CAPM

	CEM	FEM	REM
C	0.0415*** (0.0000)	0.0973*** (0.0000)	0.0498*** (0.0000)
R_m	1.1197*** (0.0369)	-2.5376* (0.0520)	2.3622* (0.0607)
R^2	0.0219	0.2710	0.0146
F-stat	3.7549* (0.0543)	1.4762* (0.0620)	2.4929 (0.1162)
DW	1.9543	2.4813	1.7398
CHOW-test		1.5204* (0.0506)	
Hausman test			1.5369 (0.2151)
LM test	-	-	-

Notes: Dependent Variable: portfolio return in period, $R_{i,j}$; * $p < 0.10$; ** $p < 0.05$; and *** $p < 0.01$; Figures in parentheses are standard robust to heteroscedasticity using White corrected; DW-statistic is Durbin-Watson d -test for autocorrelation; number of observation is 170.

From the results of testing the three models above, regression testing using the random effect model (REM) is more appropriate because the results of the Chow-test are smaller than $\alpha = 0.10$ and those of the Hausman test are greater than $\alpha = 0.10$. The ability to vary the explanation of the independent variable on the dependent variable is very low (1.46 percent). This indicates that by using only one single variable in the CAPM model, the accuracy in explaining the effect of the relationship of the independent variable with the dependent variable is very limited.

3.2.2. Regression Testing Model 2: Three-Factor Model of Fama and French.

Table 3 above shows that from the three alternative models that appear, FEM is more appropriate for explaining the effect of the independent variable on the dependent variable in the three-factor model because the F value of the Chow-test and Hausman-test is smaller than $\alpha = 0.05$. The test results of the three factors from Fama and French, showed that two factors have a significant positive effect on stock returns; namely, company size (SMB) and book value to market value (HML). This shows that the test results on the SMB variable have a statistically positive and significant effect on stock returns. This means that if each growth in size and book value against the market value of the company's stock is 1, it will cause an increase in stock returns of 0.4019 and 0.6502. The results of this test partially support the research conducted by Pasaribu (2009), in which the SMB and HML variables have a positive and significant effect on the portfolio of returns on shares on the Indonesian Stock Exchange. However, this is different from the results of the research conducted by Sudyatno and Irsad (2011) who found that risk premiums; namely, market returns, have a positive effect and that two of the Fama and French factors cannot explain the behavior of stock returns in Indonesia.

Table 3. Regression Test Results for Three-Factor Model of Fama and French

	CEM	FEM	REM
C	-0.0023 (0.1640)	- 0.0124*** (0.0003)	-0.0052* (0.0892)
Rm	-0.3394** (0.0429)	0.2662 (0.2997)	-0.2200 (0.3415)
SMB	0.4313*** (0.0000)	0.4019*** (0.0000)	0.5599*** (0.0000)
HML	0.5788*** (0.0000)	0.6502*** (0.0000)	0.4583*** (0.0000)
R ²	0.9604	0.9777	0.9147
F-stat	1,342. 831*** (0.0000)	162.1691*** (0.0000)	593.5539*** (0.0000)
DW	1.6576	2.2434	1.8202
CHOW-test		5.0323*** (0.0000)	
Hausman test			7.9109** (0.0479)
LM test			

Notes: Dependent Variable: portfolio return in period, $R_{i,t}$; * $p < 0.10$; ** $p < 0.05$; and *** $p < 0.01$; Figures in parentheses are standard robust to heteroscedasticity using White corrected; DW-statistic is Durbin-Watson d -test for autocorrelation; number of observation is 170.

Furthermore, the F statistic test aims to test whether all the independent variables included in the model have a joint influence on the dependent variable (Ghozali, 2013: 98). The simultaneous test results show that the calculated F stat is 588,381 and that the F table (0.05; 3; 170) is 2.6049. The test results show that, together, Rm, SMB, and HML have a significant effect on stock returns. The coefficient of determination (R^2) is used to measure how far the ability of the model explains the variation of the dependent variable (Ghozali, 2013: 97). If the value of R^2 approaches one it means that the independent variables provide almost all the information needed in explaining the dependent variable (Rustiono, 2008). In Table 3 the coefficient of determination (R^2) is 0.914 and the adjusted R^2 is 0.912. In conclusion, the ability of Rm, SMB, and HML to explain stock returns is very high, which is equal to 91.20%, while the remaining 7.07% is influenced by other factors.

3.3.3. Regression Testing Model 3: Five-Factor Model from Fama and French.

The following is a test for the Five-Factor Model of Fama and French (2015) in the Indonesian stock market, especially in companies in the financial sector. The t-statistics on this model are presented in Table 4 below. Based on the results of testing the t-statistics in Table 4, the results that are consistent with the testing of the Fama and French three-factor model; namely, the two LnSMB and LnHML variables in this model, are also significant and positive in explaining the variability in stock returns on the Indonesian Stock Exchange. Thus, the profitability and investment factor variables in the Fama and French five-factor model do not provide empirical evidence explaining the rate of return of shares on the Indonesian Stock Exchange. The results of this test are in line with the study conducted by Nguyen, Ulku., and Zhang (2015), and Fama and French (2015a) who stated that profitability and investment variables do not fully explain the relationship with the portfolio of stock returns if combined in a five-factor model. The results of the F statistical test, show that they have an influence and are significant on the stock returns. Furthermore, the variability of the independent variables in explaining the dependent variable, stock returns, is 48.20%.

Table 4. Regression Test Results for Five-Factor Model of Fama and French

Variable	Model 1 (ROA)		
	CEM	FEM	REM
C	-0.0029* (0.0833)	- 0.0124*** (0.0003)	-0.0065** (0.0436)
Rm	-0.2719 (0.1090)	0.3281 (0.2554)	-0.1701 (0.4896)
SMB	0.4297*** (0.0000)	0.4147*** (0.0000)	0.5487*** (0.0000)
HML	0.5822*** (0.0000)	0.6299*** (0.0000)	0.4700*** (0.0000)
PF	-0.0295** (0.0281)	-0.0242** (0.0281)	-0.0146 (0.4967)
INVSTM	0.0089 (0.4414)	0.0093 (0.4439)	0.0326 (0.1363)
R ²	0.9684	0.9773	0.916
F-stat	1,006.766*** (0.0000)	148.5002*** (0.0000)	358.3975*** (0.0000)
DW	1.6292	2.1845	1.7850
CHOW-test		4.9621*** (0.0000)	
Hausman test			10.5258* (0.0616)
LM test			

Notes: Dependent Variable: portfolio return in period, $R_{i,t}$; * $p < 0.10$; ** $p < 0.05$; and *** $p < 0.0$; Figures in parentheses are standard robust to heteroscedasticity using White corrected; DW-statistic is Durbin- Watson d -test for autocorrelation; number of observation is 170

4. Conclusion and Suggestion

Based on the results of the data analysis and discussion in the previous section, the following conclusions have been derived. This study empirically tested the asset valuation models, the three-factor model of Fama and French, and the five-factor model of Fama and French on the portfolio of stock returns of financial sector companies on the Indonesian Stock Exchange. 34 companies were used as samples during the period of 2012 to 2016. The results of testing the CAPM model show that market returns have a positive and partially significant effect on the rate of return of shares of companies in the financial sector. The results of the testing of the three-factor model of Fama and French show that the Small Minus Big variable (SMB), as a proxy for company size (return), and the high minus low variable (HML), as a proxy for book value to market value (BE/ME), have a positive and significant influence on the rate of return of shares of companies in the financial sector. The results of testing the five-factor model from Fama and French show that only two of the five model variables; namely, the Small Minus Big variable (SMB), as a proxy for company size (Size), and the High Minus Low variable (HML), as a proxy for Book Value to Market Value (BE/ME), have a positive and significant effect on the rate of return of shares of companies in the financial sector. Variable market returns (Rm) in both models, namely, the three-factor model of Fama and French and the five-factor model of Fama and French did not affect the rate of return of shares of companies in the financial sector. In addition, the profitability factor (PF) and investment variable (Invst) in the five-factor model Fama and French have a negative effect but are not significant on the rate of return of shares of companies in the financial sector.

Based on the results of the data analysis of the three models in this study, the following are some of the suggestions given. As only two variables; namely, the SMB variable and the HML variable have a positive and significant influence on the three-factor model and the Fama and French five-factor model, it is recommended that investors make their investment decisions, prioritizing the companies which have a large size of return and a high ratio of book value of equity to the market value of equity. Considering that this research is limited to the use of a small

sample size and focuses only on the financial sector, it cannot be generalized to other sectors; hence, it is suggested that further research be conducted to expand the sample size and use various sectors of the stock market.

References

- Ang, A., Hodrick, R. J., Xing, Y., & Zhang, X. (2006). "The cross-section of volatility and expected returns." *Journal of Finance* 61, 259–299.
- Asgharian, Hossein & Hansson, Bjorn (1998). "Cross Sectional Analysis of the Swedish stock market." http://www.nek.lu.se/publications/workpap.Paper/WP02_19.pdf. diakses 23 Agustus 2016.
- Banz, Rolf W. (1981). "The Relationship Between Return and Market Value of Common Stock." *Journal of Financial Economics*. Vol. 9, pp. 3-18.
- Basu, S. (1997). "Investment Performances of Common Stocks in Relation to Their Price Earnings Ratios: A Test of the Efficient Market Hypothesis." *Journal of Finance*, Vol. 12, pp. 129-156.
- Basu, S. (1983). "The relationship between earnings yield, market value, and return for NYSE common stocks: Further evidence." *Journal of financial economics* 12, 129-156.
- Bhandari, L. (1988). "Debt/Equity Ratio and Expected Common Stock Returns: Empirical Evidence." *Journal of Finance*, 43: 507-528.
- Black, Fischer, Michael C. Jensen, Myron Scholes, (1972), The capital asset pricing model: Some empirical tests, in *Studies in the Theory of Capital Markets*. Jensen MC, ed. New York: Praeger. 79-121.
- Bodie, Z. Kane, A. & Marcus, A.J, (2005). "Investment". Terjemahan Zuliani D. Dan Budi Wibowo. Jakarta Salemba Empat.
- Carhart, Mark M., (1997), "On persistence in mutual fund performance," *Journal of Finance*, 52: 57-82.
- Chan, L.K.C., Hamao, Y., Lakonishok, J., (1991). "Fundamentals and stock returns in Japan." *Journal of Finance* 46, 1739–1789.
- Charitou, Andreas and Constantinidis, Eleni, (2004). "Size and Book-to-Market Factors in Earnings and Stock Returns: Empirical Evidence from Japan, (online), (<http://www.business.uiuc.edu/accountancy/research/vkz.center/pers/Charitou.pdf>). diakses 23 Agustus 2016.
- Damar Hardianto dan Suherman, (2007). "Pengujian Fama-French Three-Factor Model di Indonesia." *Jurnal Keuangan dan Perbankan*, Vol. 13, No. 2 Mei, Hal. 198-208.
- Davis James L., Eugene F. Fama, and Kenneth R. French, (2000), "Characteristics, covariances, and average returns: 1929-1997", *Journal of Finance*, 55:389-406.
- Dede Irawan Saputra, (2008). "Perbandingan Fama and French Three Factor Model dengan Capital Asset Pricing Model." *Jurnal Riset Akuntansi dan Keuangan*, Vol. 4. No. 2 Agustus, Hal. 132-145.
- Drew, Michael, E. Naughton, T., and Veeraraghavan, Madhu, (2003). "Firm Size, Book-to-Market Equity and Security Returns: Evidence from the Shanghai Stock Exchange." *Australian Journal of Management*, 28.2: 135-136.
- Fama Eugene F, and James D. MacBeth. (1973), "Risk, return, and equilibrium: Empirical tests." *Journal of Political Economy*. 81:607-636.
- Fama, E. F., & French, K. R. (2015a.) "A five-factor asset pricing model." *Journal of Financial Economics* 116, 1–22.
- Fama, E. F., & French, K. R., (2015b). International tests of a five-factor asset pricing model. Working Paper. Retrieved from SSRN: ssrn.com/abstract=2622782 . diakses 23 Agustus 2016.
- Fama, E.F., French, K.R. (1992). "The cross-section of expected stock returns." *Journal of Finance* 47, 427–465.
- Fama, Eugene F., (1996), "Multifactor portfolio efficiency and multifactor asset pricing," *Journal of Financial and Quantitative Analysis* 31, 441–465.
- Fama, Eugene F., dan Kenneth R. French. (1993). "Common risk factors in the returns on stocks and bonds." *Journal of Financial Economics* 33, 3-56.
- Gujarati, D. 2003. *Basic Econometric*. Mc-Grawhill. New York.
- Hodoshima, J. Garza, G.X. & Kimura, M. (2000). "Cross Sectional Analysis of Return and Beta in Japan." *Journal Economic and Business*, 515-553.
- Homsud, N., Wasunsakul, J., Phuangnark, S., and Joongpong, J, (2009). "A Study of Fama and French Three Factors Model and Capital Asset Pricing Model in the Stock Exchange of Thailand." *International Research Journal of Finance and Economics*, EuroJournals Publishing, Inc.
- Isna Yuningsih dan Rizky Yudaruddin. (2007). "Pengaruh Model Tiga Faktor Terhadap Return Saham". *Akuntabilitas*, September, Hal. 79-84.
- Jegadeesh, N., Titman, S. (1993). "Returns to buying winners and selling losers: implications for stock market efficiency." *Journal of Finance* 48, 65–91.
- Jogiyanto Hartono. (2003). "Teori Portofolio dan Analisis Investasi". Yogyakarta : BPFE Yogyakarta.

- Lintner, John. 1(1965). "The valuation of risk assets and the selection of risky investments in stock portfolios and capital budgets," *Review of Economics and Statistics* 47, 13-37
- Mossin, J. (1966). "Equilibrium in a Capital Asset Market." *Econometrica* 34(4), 768-783
- Nguyen Nh., Ulku N., and Zhang J. (2015). The Fama-French five factor model: Evidence from Vietnam. Working Paper.
- Novy-Marx, R. (2013). "The order side of value: The gross profitability premium.", *Journal of Financial Economics* 108, 1-28.
- Pastor, L., & Stambaugh, R. F., (2003). "Liquidity risk and expected stock returns." *Journal of Political Economy* 111, 642-685.
- Reilly, Frank, K., and Brown, Keith, (2004). "Investment Analysis and Portfolio Management." Seventh Edition, USA: South-Western.
- Rosenberg, B., Reid, K. and Lanstein, R. (1985). "Persuasive evidence of market inefficiency." *Journal of Portfolio Management* 11, 9-17.
- Ross, S, (1976). "The Arbitrage Pricing Theory of Capital Asset Pricing". *Jornal of Economic Theory* 13: 341-360.
- Sandoval, A. Eduardo & Saens, N. Rodrig., Author (2004). "The Conditional Relationship Between Portfolio Beta and Return: Evidence from Latin America," *Cuadernos de Economfa*, 41. 4:65-89.
- Sharpe, William F. (1964). Capital asset prices: A theory of market equilibrium under conditions of risk. *Journal of Finance* 19, 425-442.
- Stock Market". http://www.nek.lu.se/publications/workpap/Paper/WP02_19.pdf. diakses 23 Agustus 2016.
- Sudiyatno B., dan Irsyad M. (2011). "Menguji model tiga faktor Fama dan French dalam mempengaruhi return saham studi pada saham LQ45 di Bursa Efek Indonesia". *Jurnal Bisnis dan Ekonomi (JBE)* 18 (2): 126-136.
- Tandelilin E. ((2010). *Portofolio dan Investasi, teori dan aplikasi*. Edisi Pertama, Penerbit Kanisius, Yogyakarta.
- Titman, S., Wei, K., and Xie, F. (2004). "Capital investments and stock returns," *Journal of Financial and Quantitative Analysis* 39, 677-700.



Economic Valuation of Military Checkpoint-Induced Travel Time Variability in Abuja, Nigeria (2012-2017)

Ibrahim Gerarh Umaru¹, Abubakar Mohammed Tanko²

¹ Department of Economics, Kaduna State University, Kaduna-Nigeria

² Department of Economics, Nigerian Defence Academy, Kaduna-Nigeria

Correspondence: Ibrahim Gerarh Umaru. Email: ibrahim.umaru@kasu.edu.ng

Abstract

Between 2009 and 2016, Nigeria witnessed insurgency attacks from such militant groups as Movement for the Emancipation of Niger Delta (MEND), Movement for the Actualization of the Sovereign State of Biafra (MASSOB) and O'odua People's Congress (OPC). The most vicious and infamous threat yet was from the self-styled terrorist group going by the name, Jama'atuahlus-sunnah lid-da'awatiwal Jihad, otherwise known as Boko Haram. The group claimed responsibility for spate of bombings recorded not only within the north-east region of the country but on private and public buildings, bus stations, shopping malls, recreation centres and markets in major cities such as Kaduna, Kano and Abuja, Nigeria. The apparent threat to national security and perhaps most importantly to lives in these cities led security operatives, especially the Military and the Police, to erect checkpoints at strategic locations along major arteries and roads adjudged to be of strategic interest to the terrorists as one of the effective measures to curtail the activity of the terror groups. One of the fallouts of this measure is the phenomenon of obstruction of traffic and delays in reaching travel destinations by commuters often referred to in technical terms as travel time variability. Using the Nolan and Small (1995) modified economic valuation model and the erection of military checkpoints on the three highways in Abuja-Nigeria between 2012 and 2016 as reference points, this study examines the implication of the travel time variability in the federal capital territory (FCT). The findings of the study show that the mounting of military checkpoints might have cost the FCT between N8.25 and N9.58 billion annually within the period. For the period under study (2012 - 2016), the FCT economy might have lost between N40 and N59 billion to obstruction and traffic congestion occasioned by the mounting of military checkpoints.

Keywords: Military Checkpoint, FCT Highways, Travel Time, Time Variability, Start Time, Insurgency, Destination

INTRODUCTION

Since 2009 the Nigerian authorities have been battling the security threat posed by insurgency and terrorist groups Jama'atuahlus-sunnah lid-da'awatiwal jihad, (otherwise known as Boko Haram), Movement for the Emancipation of Niger Delta (MEND), Movement for the Actualization of the Sovereign State of Biafra (MASSOB) and O'odua People's Congress (OPC). The daring and systematic nature of the attacks compelled the implementation of certain counter-terrorism measures. A major strategy deployed by the Nigerian security apparatus was the establishment of military checkpoints along major highways and arterial roads to major cities. These checkpoints were intended

to assist the military in conducting surveillance using the stop and search system of motorists plying such roads and highways.

In the Federal Capital Territory, Abuja military checkpoints were mounted on the three major highways, namely, Nyanya-Keffi motorway, Murtala Mohammed (Kubwa-Zuba) expressway and Umar Musa Yar'adua (Airport Road) motorway. In spite of the intended benefit of mounting the military checkpoints in terms safety and physical security of road users, commuters may probably have found those checkpoints most inconveniencing because of the physical exhaustion, delays in arrival time to destination and additional economic costs that were often associated with them on a daily basis. What is more, when translated in monetary terms, all this may have had serious repercussions for the economy, especially for the period these checkpoints were enforced. Herein lies the rationale for studying the phenomenon of traffic congestion and the associated problem of travel time variability in the FCT.

The remainder of the paper is organized in three parts. The fourth part interprets the results. The third section outlines the methodology adopted for the study. The next section clarifies key concepts and reviews of extant literature. It also attempts to bring out the gaps in the literature. The last section forms the concluding part of the discourse.

LITERATURE REVIEW

Travel time can simply be defined as the expected time duration in which a commuter travels from one point to another. Commuter travel time could vary with respect to the schedule a commuter leaves home for office, business or leisure. A commuter has the possibility of departing on an early or late schedule. Biliyamin and Abosede (2012) define travel time variability in terms of how travel times vary over time (e.g., hour-to-hour, day-to-day, week-to-week). In general, travel time variability is the variability of scheduled travel time of a commuter from his/her departure to arrival point over the period of existence of established military checkpoints.

A number of factors are often responsible for the discrepancy between scheduled arrival and actual arrival times. One such factor is traffic congestion. Traffic congestion is defined as a condition on transport networks that occurs as use increases and is characterized by slower speeds, higher trip times and increased vehicular queuing (McKnight, Levison, Ozkay, Kamga and Paaswell, 2004). This is particularly typical with the physical use of roads by vehicles. Travel congestion or delay or jam can make trip times longer, and increases are queuing. Congestion may result from a decrease in capacity, accidents on the roads being closed, or delay or jam or even checkpoints mounted. What is critical about traffic congestion is that it imposes a substantial operational and monetary penalty on-road transportation by increasing the time required to provide service and commute from one point to another (McKnight, Levison, Ozkay, Kamga and Paaswell, 2004). In most heavily built-up cities, heavy traffic congestion is an everyday occurrence but largely as happenstance. It could, however, be the outcome of a deliberate action by the relevant security authorities to either forestall or counter an imminent breach of public peace or even restore tranquility to a troubled or war-torn area within their sphere of control. Such action could come in form of a police or military checkpoint.

A military checkpoint is a strategic position stationed on a road or pathway characterized by obstructive objects used to slow down or stop the movement of people and/or vehicles (FMI, 2004). Such checkpoints provide many advantages, including the ability to control how people enter the town/city so that security personnel can screen entrants to identify troublemakers (be they criminals, terrorists or simple rabble-rousers) and locate contraband items or lethal weapons such as improvised explosive devices (IEDs) (FMI, 2004).

The main impetus for time allocation and travel time variability draws its rationale from time allocation theory and theory of Consumer behavior. Travel behaviour and valuation of travel time have been explored for more than thirty (30) years by researchers from different perspectives. The theories of time allocation deal with the issue of time valuation. Many concepts of value of time emerge, depending on how a period of time is looked at; as a valuable resource, as something to be reassigned or as something to be reduced. Most researchers of this subject apply Consumer Behavior theory to develop models and explain the valuation of travel time savings.

Consumer theory models individual behavior as if what the individual does (consume) is governed by the search for satisfaction, which in turn is governed by his income. Becker (1965) had postulated the idea of 'final goods' as those which directly induce satisfaction. He paid attention to market goods and entered utility and time as a necessary input to prepare final goods. His main idea was that work time was, in fact, total time in a period minus preparation-consumption time. Johnson (1966) establishes that the reason behind a value of travel time equal to the wage rate was the absence of work time in the utility function. He shows that correcting this omission led to a value of time equal to the wage rate plus the subjective value of work (ratio between the marginal utility of work and the marginal utility of income). Johnson (1966) claims that this was the value of leisure, which in turn was equal to the value of travel time.

Oort (1969) suggests that travel time should be included in utility as well, and a third term appeared in the subjective value of travel time notion; namely, the value of the direct perception of travel time in utility. This is also intuitively attractive, as an exogenous reduction in travel time itself, which might make it even more attractive if travel is pleasurable in itself. De Serpa (1971) makes a significant input to the discussion of the value of time by introducing explicitly a set of technical constraints relating time and good. He postulates a utility function dependent on all goods and all time periods (which he called "activities"), including work and travel. He outlines two different concepts of time value within this framework. First is the value of time as a resource, which is the value of extending the time period, equivalent to the ratio between the marginal utility of (total) time and the marginal utility of income. The second is the value of time allocated to a certain activity (value of time as a commodity), given by the rate of substitution between that activity and money if the individual assigns more time to an activity than the minimum required.

The first to formulate a model for consumer behaviour in which utility depended only on time assigned to activities was Evans (1972). He criticizes Johnson's (1966) work because of the confusion between value of time and value of leisure. He also questions Oort (1969) who compared a reduction in travel time with an extension of the day. Finally Evans (1972) finds the possibility of a zero value for the marginal utility of income for individuals that earn money faster than their capability to spend it; thus, their time constraint is binding and the income constraint is not, which means an infinite value of time as a resource and an infinite value of saving time. Jara-Diaz (2000) remodels the works of Becker (1965), Johnson (1966), Oort (1969), and De Serpa (1971) and arrives at what he calls the 'subjective value of travel time' (SVTT).

Others present a different concept of value of time that flow from different theories of time allocation and came up with three components of value of saving travel time: the wage rate, the value of work and the value of travel as a commodity, and show what one obtains when the rate of substitution between travel time and travel cost is calculated from a utility function estimated from discrete travel choice models. The model highlights coincidences and differences showing that there has been an evolution towards a better understanding of the elements that determine money equivalencies for the variation in time assigned to activities. From a time value equal to wage rate for all activities, the model develops values that are activity-specific due to the introduction of new important elements in the underlying model for consumer behavior, affecting the arguments of utility and set of constraints.

Another major contribution to the work on travel time shows up in the work of Small (1982). He includes departure time as a variable, which influences utility, travel time and travel cost. The introduction of an institutional constraint that links departure time, working hours, and the wage rate generates a resource value of time that depends on work schedule. Therefore, a reduction in travel time induced by exogenous factors might favor a pleasurable rescheduling of activities. He, therefore, provides a more attractive framework to model the impact of travel time variability on arrival times. This he did by taking into account the consequences of arriving at destination earlier or later than desired and individuals choosing the time at which they depart. In his model, commuters adapt their behaviour to the presence of variable travel times by choosing earlier departure times.

Barely after a decade, Noland and Small (1995) developed a general framework that can be used to analyze total expected cost function of travel time. The basic idea behind this framework is to follow the economizing behaviour of an average commuter and determine the risk of arriving early or late to destination. They argue that essentially a traveler or commuter usually has a certain preferred time for arrival for his/her journey. The goal, therefore, is

to reach the destination by finding the optimal departure time from the start-point, given the estimations of values of schedule delay early and of schedule delay late. Their framework is so flexible that it explicitly recognizes the fact that travel time variability can assume different distributions in a day and the need to fit empirical data to the right distribution. Since this landmark publication, several attempts have been made to empirically measure travel time variability due to congestion and their associated cost. Such pioneering works include Alcantara de Vasconcellos (2004), Srinivasan and Rogers (2005), De Borger and Fosgerau (2006, 2008), Börjesson, Fosgerau and Algers (2009), Börjesson and Eliasson (2010), Beaud, Blayac and Stephen (2016), Wanjek and Hauger (2017), Buchel and Corman (2018).

Travel time variability research in Nigeria is of recent history. The available studies seem to concentrate mostly on merely estimating travel time variability, with only few of them attempting to identify and analyze the channels through which variability in travel time affects the economy. For instance, Olatunde (2016) carried a study on the impact of traffic congestion on commuters travel time in Lagos state. Its findings showed that the factors identified that influence traffic congestion in Lagos state were monetary cost, commuters scheduled time, road side and on-side parking, road side trading, total disregard for traffic regulations by road users and population of cars on the road. Similarly, Bilyamin and Abosede (2012) carry out a study on effects of congestion and travel time variability along Abuja-Keffi corridor in Nigeria. The study found that uncontrolled motorization is one of the major causes of traffic congestion along the outer ring corridor of Abuja due to the absence of adequate mitigation measures.

Another relevant study noteworthy is the Transport Secretariat of the Federal Capital Territory Administration/Nigerian Institute of Transport Technology (FCTA/NITT, 2009) conducted to analyze the vehicular and passenger traffic flow pattern and characteristics generated and attracted to Federal Capital City (FCC) in order to provide vital, up-date and reliable database for transport and traffic policy and planning programmes for FCC. The results of the study reveal that FCC attracts and generates vehicular traffic of 1,334,784 weekly. Out of these, 723,506 representing 54.2 percent are inbound traffic while 611,278 constituting 45.8 percent are outbound traffic; Out of the six entry and exit routes, Nyanya road records the highest vehicular traffic volume of 357,852. Out of this 54.8 percent are outbound while 45.2 percent are inbound. In terms of passenger traffic, FCC generated and attracted 9,017,712 passenger trips weekly. Out of this, 4,860,942 were inbound while 4,156,770 were outbound. Analysis of the hourly traffic flow reveals that 7.00am to 9.00am could be regarded as the morning peak period, while 8.00am to 9.00am with highest traffic flow could be regarded as morning peak hour for both passenger and vehicular traffic. The hours between 4.00pm and 6.00pm could be regarded as evening peak period for both passenger and vehicular traffic. However, 4.00pm to 5.00pm records the highest passenger trips of 886,025, which could be regarded as the evening peak hour. The route analysis also reveals that Nyanya road records the highest passenger trips of 2,962,877 followed by Kubwa road with 1,728,781. Mpape road recorded the least passenger trip in the city. A vehicular composition analysis of the city traffic reveals that cars are most dominant means of transportation in Abuja followed by minibuses. Although, commercial motorcycles have been banned in FCC, motorcycle traffic recorded some remarkable traffic volume of 27,447 on Keffi-Nyanya road.

Insightful as these studies might have been to our general understanding of urban transport infrastructure, traffic congestion and travel time, none has attempted to quantify in monetary terms the impact of the recent establishment of military checkpoints on Abuja highways and commuters' travel time as well as its impact on the local economy.

METHODOLOGY

Model Specification

This study adopts the Koster, Verhoef and Kroes (2008) approach of estimating expected cost function of travel time. This approach utilizes Noland and Small (1995) general framework which assumes that people make a trade-off getting to their destination between being late and being early which can be expressed as:

$$TEC = \alpha^*(T) + \beta^*(SDE) + \gamma^*(SDL) + \lambda^*(D) \quad (1)$$

where:

α = value of time for a traveller (VoT)

β = value of schedule delay early (*VSDE*)

γ = value of schedule delay late (*VSDL*)

T = travel time

SDE = schedule delay early

SDL = schedule delay late

TEC = total expected costs

D = Additional dummy taking a value of one if $SDL > 1$, to account for extra cost due to arriving late. The model also assumes that the distribution of travel times is not constant over time. The basic model can be briefly described as follows.

A traveller or commuter usually has a certain preferred time for arrival (*PAT*) on his/her journey. The goal therefore is to reach the destination by finding the optimal departure time (t_h) from the start-point, given the estimations of *VSDE* and *VSDL* and the travel time distribution. An intuitive feel of this can be likened to a scenario where the traveller decides when he/she wants to arrive at destination, and then decides when he/she would have to leave the start-point given all the 'troubles' to encounter during the trip.

If T denotes travel time, then the traveller is said to be late if $t_h + T(t_h, \theta) > PAT$, and early if $t_h + T(t_h, \theta) < PAT$ for a realization of T . The travel time T depends on the time that a traveller departs the start-point and other factors θ . To calculate the costs, the cost function is split into three parts:

$$TEC = EC^\alpha + EC^\beta + EC^\gamma \quad (2)$$

where:

$$EC^\alpha = \int_0^{\infty} \alpha * T * f(T) dT = \alpha * [E(T)] \quad (3)$$

which assumes a fixed distribution over time, with α being the value of time for a traveler and $E(T)$ the expectation of the travel time.

$$\begin{aligned} EC^\beta &= \int_0^{PAT-t_h} \beta * (PAT - T - t_h) f(T) dT \\ &= \int_0^{PAT-t_h} \beta * (PAT - t_h) * f(T) dT - \int_0^{PAT-t_h} \beta * T * f(T) dT \\ &= \beta * (PAT - t_h) * F(PAT - t_h) - \left[\int_0^{\infty} \beta * T * f(T) dT - \int_{PAT-t_h}^{\infty} \beta * T * f(T) dT \right] \\ &= \beta * (PAT - t_h) * F(PAT - t_h) - \beta * \left[E(T) - \int_{PAT-t_h}^{\infty} T * f(T) dT \right] \end{aligned} \quad (4)$$

where the last integral is a part of the expectation since the integral is not starting at 0, but at $PAT - t_h$. If t_h is equal to PAT , which means a late departure time from home, the costs for being early tend towards zero because the chance of being early is zero, and the partial expectation is equal to $E(T)$.

$$\begin{aligned} EC^\gamma &= \int_{PAT-t_h}^{\infty} \gamma * (T - (PAT - t_h)) f(T) dT \\ &= - \int_{PAT-t_h}^{\infty} \gamma * (PAT - t_h) * f(T) dT + \int_{PAT-t_h}^{\infty} \gamma * T * f(T) dT \\ &= -\gamma * (PAT - t_h) * [1 - F(PAT - t_h)] + \gamma * \left[\int_{PAT-t_h}^{\infty} T * f(T) dT \right] \end{aligned} \quad (5)$$

The expected costs for being late tend to move in the reverse direction with the costs of being early. That is, if the traveller or commuter departs earlier from home, t_h will be smaller and the chance of being late would be smaller so that the first part of the costs decrease. The costs of being late are maximal if t_h is equal to PAT . In that case the integral is equal to the expectation $E(T)$. The optimal departure time can then be calculated using the first derivation of the total expected costs with respect to t_h when setting to zero. Koster, Verhoef and Kroes (2008) have argued that it is not quite safe to assume that travel time is independent of the departure from the start-point. However,

the closed-form total expected cost functions are really useful for application. In view of this, the travel costs can be computed for every departure time from the start-point, given a certain distribution and a preferred arrival time, and subject to choosing the departure time with the lowest costs.

Commuter time is affected by numerous factors, leading to uncertainty. The stochastic nature of those influencing factors which have been classified by van Oort, Sparing, Brands and Goverde (2015) as either internal or external factors leads to the discrepancy between scheduled and actual time of arrival at destination which is often perceived as unreliability and highly inconveniencing for commuters and other road users. Bates, Polak, Jones and Cook (2001) have found that a reduction in travel time variability is even more valuable to commuters than a reduction in travel time itself. Estimating travel time variability and its economic costs is therefore important for gaining knowledge of the deteriorations and ameliorations in daily traffic and for transport policy. Understanding travel time variability in reality however requires some knowledge of probabilistic distributions as they are capable of describing the nature and pattern of travel time variability. Understanding the distributions of travel time distribution is indeed a vital component for analyzing the cost of unreliability to commuters (Mazloumi, Currie and Rose, 2010; Buch el and Corman, 2018). Three theoretical probabilistic distributions have been suggested for empirically estimating the cost of travel time, namely exponential, Weibull and gamma distribution (Koster, Kroes and Verhoef, 2011). For a brief discussion of these distributions, see the Appendix.

Data and Methods

This study relied largely on primary data for analysis. Data were collected on the socio-demographics of respondents and information related to their travel routes, travel means, travel time and travel cost. Other specific information sought included those on their routine trips on the three major road arteries in the FCT, namely Umar MusaYar'adua expressway, Nyanya-Keffi expressway and Murtala Mohammed Expressway. As real-time collecting data on the three routes would be too overwhelming, a suitable sampling method of FCT residents was adopted for the study. The official census figures provided by National Bureau of Statistics (NBS, 2009) was used as the sampling frame, while the UNFPA (2014)'s projected population figures for the FCT and Yamane (1964) formula were employed to determine the sample size for the study as shown in Table 1.

Table 1: Sample size determination

Area council	2006 Population [†]		2014 Projected Population [‡]	Desired sample (d) = [x (c)/100]
	Number (a)	% of Total (b)		
Abaji	58,642	4.17	123,349.4	16
Abuja Municipal	776,298	55.2	1,633,762	220
Bwari	229,274	16.3	529,565	71
Gwagwalada	158,618	11.3	333,820.3	43
Kuje	97,233	6.9	204,631.9	26
Kwali	86,174	6.1	181,357.7	24
Total	1,406,239	100	2,959,507	400 [#]

Note:

$$\# - s = \frac{N}{3 + N(ME^2)} = \frac{2,959,507}{3 + 2,959,507(0.05^2)} = 399.84 \approx 400$$

Source:

[†] - NBS (2009)

[‡] - Projected based on NBS (2012)

A simple random sampling method and the random number table were used as sampling instruments. Thereafter, a multi-stage sampling procedure was followed to select the sample elements. To select 31 percent of the over 60 districts and major settlements in the FCT in identifying the streets and households to be interviewed, the Yamane (1964) was employed. Furthermore, to identify the appropriate sampling units in each settlement, the latter was

divided into four cardinal points and the allocated number per settlement was shared equally among the cardinal points. Then a simple random sampling method was used to identify specific households in the selected street to be interviewed. In particular, settlements with organized layouts, especially within the city centre, street numbers and neighbourhood identification were used as additional sampling frames. For unorganized settlements, the Umaru (2013) method of spinning a bottle after each sampling unit was identified and employed. The Statistical Package for Social Science (SPSS) 18 and E-views 9 were used to analyze data collected from the field.

The following eight-step procedure was used to analyze the data collected.

STEP 1: Total costs of travel time for periods before August 2015 and after August 2015 were determined.

STEP 2: Having estimated total costs of travel time for before August 2015 and after August 2015, the value of the travel T was estimated.

STEP 3: To determine if there were differences in travel time before and after 2015, the Chow Test was employed.

STEP 4: Data on other characteristics of commuters was analyzed.

STEP 5: Values of schedule delay early and schedule delay late were determined.

STEP 6: A probability distribution fitting to the observed travel times was undertaken.

STEP 7: The total expected cost in eq. (1), using the distribution of the outcome of Step 6 for every time period was calculated.

STEP 8: The overall total cost of travel time to the local economy was extrapolated based on FCT population and sample estimate of total cost of travel time.

DATA ANALYSIS

The basic socio-demographic characteristics of respondents are shown in Table 4.1. The table shows that public servants represented 48.3 percent of the total number of respondents while the least was the casual workers recording 3.8 percent. As for their educational attainment, respondents who indicated having completed tertiary education represented 77.2 percent whereas those with secondary school leaving certificates were a-fifth of the total number. Majority of the respondents were either married or living in a household characterized by extended family relationship. Further analysis of socio-demographics will reveal that majority (54.6 percent) of the respondents indicated they visited the city centre within the study area for work; followed by those on business (34.6 percent) and for leisure (6.4 percent). Respondents who commuted before and after August 2015 were in the majority (52.4 percent).

Further analysis of socio-demographic data from survey showed that about 81 percent of household members commute to city centre on routine basis. Further analysis revealed that the mean travel time for an average commuter was 108.209 minutes, schedule delay early 3.48877 minutes and schedule delay late 44.0083 minutes while the respective standard deviations were 32.9197 minutes, 3.65401 minutes and 23.4772 (Table 1).

Table 1: Socio-demographic statistics of respondents

SOCIO-DEMOGRAPHICS					
<i>Occupation</i>	<i>Student</i>	<i>Public Servant</i>	<i>Business</i>	<i>Casual W.</i>	<i>Contract</i>
	9.2	48.3	32.8	3.8	5.9
<i>Education Level</i>	<i>Informal</i>	<i>Primary</i>	<i>Secondary</i>	<i>Tertiary</i>	
	0.8	7.6	19.8	71.8	
<i>Purpose of Visit</i>	<i>Work</i>	<i>Business</i>	<i>Leisure</i>	<i>Other</i>	
	54.5	34.6	6.4	4.6	
<i>Currency of Visit</i>	<i>Daily</i>	<i>Weekly</i>	<i>Monthly</i>		
	88.3	4.6	7.1		
<i>Route</i>	<i>Airport</i>	<i>Kubwa</i>	<i>Nyanya</i>		
	27	17	56		

<i>Members of household who travel to city centre routinely</i>	<i>Age bracket</i>			
	20-30	31-40	41-50	51-60
	102	324	292	102
<i>Percentage of respondents who used the route</i>	<i>Before August 2015</i>		<i>After August 2015</i>	
	12		35.6	
			52.4	

SUMMARY STATISTICS

<i>Statistic</i>	<i>Travel time (T) in minutes</i>	<i>Schedule delay early (SDE) in minutes</i>	<i>Schedule delay late (SDL) in minutes</i>
<i>Mean</i>	108.209	3.48877	44.0083
<i>Median</i>	102.890	2.67000	39.6700
<i>Maximum</i>	205.670	21.3300	127.220
<i>Minimum</i>	45.6700	0.00000	2.00000
<i>Std. Dev.</i>	32.9197	3.65401	23.4772
<i>Sum Sq. Dev.</i>	420477	5087.024	213857.1
<i>Obs.</i>	389	382	389

Source: Author's survey, 2016

Noland and Small (1995) and Koster, Verhoef and Kroes (2007) have argued that the size of the total costs for the traveler depends on the risk probability distribution assumed for the study. So an important question is: which distribution results in the highest costs for the traveler and how much is the difference with the other distribution? Interestingly, this is an empirical matter. In order to determine which among the three optional cost-of-travel-time-variability models to use to analyze the empirical data for the study, the survey data was fit to various distributions - exponential, Weibull and gamma probability distributions) - using the QQ plot. Judging by how close the curve representing the actual curve mimicked the behaviour of empirical curve of the general total cost of travel time, it is easy from Figure 1 that, of three, the Weibull specification [(c) and (d)] performed best.

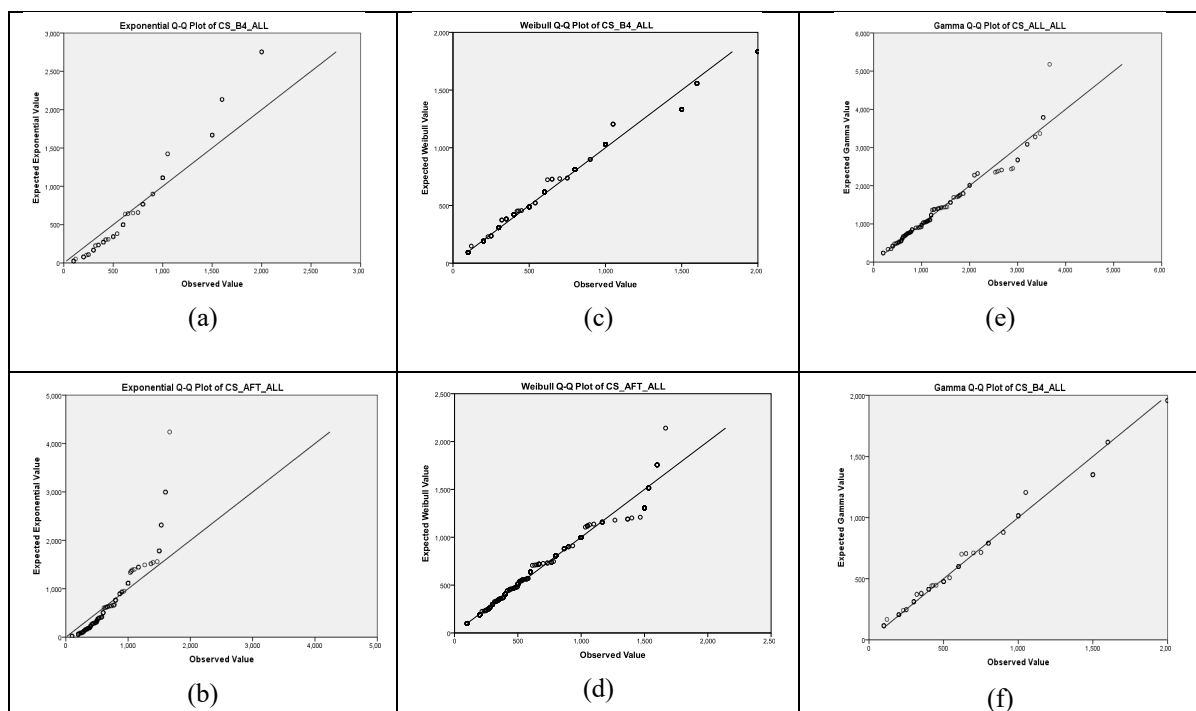

Figure 1: Distribution fitting (Exponential, Weibull and Gamma) for Travel time survey of FCT, 2015

Source: Author's survey analysis using SPSS Version 18

To determine the differentials in commuters' travel time and associated costs, the 'general' travel cost equation was estimated for 'before 2015', 'after 2015' and pooled time periods. The results are summarized in Table 2. The table shows that eight out of the twelve estimated coefficients had expected signs. Also, nine out of twelve regression coefficients were significant at 5 percent level. Other associated statistics vital for the Chow Test such as r-squared errors (R^2) and residual sum of squared errors (RSS) are shown in the lower part of the table.

Table 2: Results of the regression analysis

Variable	Before August 2015				After August 2015			
	Coef.	Std. Error	t-stat	Prob.	Coef.	Std. Error	t-stat	Prob.
Travel time	5.539	0.744	7.439	0.000	4.082	1.751	2.330	0.020
SDE	33.037	9.225	3.581	0.004	53.068	9.238	5.744	0.000
SDL	-1.893	2.569	-0.736	0.462	0.516	1.124	0.458	0.647
Dummy	375.97	78.728	4.775	0.000	489.59	78.75	6.216	0.000
R^2	0.002				-0.0047			
Ad. R^2	-0.005				-0.056			
S.E. Reg.	455.53				406.44			
RSS	79,890,964				62,445,216			
D-Watson	2.853				2.763			
Variable	Pooled (Before and After)							
	Coef.	Std. Error	t-stat.	Prob.				
Travel time	2.146	1.546	7.856	0.000				
SDE	-16.979	3.394	-5.001	0.000				
SDL	980.66	325.8	3.010	0.000				
Dummy	-164.76	183.2	-0.899	0.369				
R^2	0.061							
Ad. R^2	0.543							
S.E. Reg.	817.71							
RSS	88,432,678							
D-Watson	2.609							

Source: Author's survey analysis using SPSS Version 18

Performing the Chow Test which utilized the regression results in Table 1 as input was necessary as it helped to ascertain the feasibility of calculating the total expected costs of travel time in the study area. The results for the Chow are shown in Table 3. The calculated value of the F -statistic was 1,781. This was compared with the critical value of 3.32 for 387 and 778 degrees of freedom of RSS_R and RSS_{UR} respectively to arrive at the decision to reject the null hypothesis which stated that the military checkpoints on Abuja highways' associated costs travel time has changed between the two periods of study. Put differently, there was strong statistical evidence to suggest that the mounting of military checkpoints on Abuja highways had increased commuter travel time within the period under study. This conclusion seems to have been corroborated by the result of the additional test of equality of estimated variance as suggested by Chow (1960) and Gujarati and Porter (2009). Indeed, the value of the calculated F -statistic for differences in estimated variance was approximately 12.8, which is greater than its critical F -value (3.32).

Table 3: Chow test results

Symbol	Explanation	Restricted equation (R)	Unrestricted Equation (UR)
RSS	Residual sum of squared errors	256,000,000	274,233,618
n	Sample size	393	986

K	Number of parameters	4	4
df	Degrees of freedom	389	778
$F-Cc$	Chow's F -calculated		1,780.9
$F-C_T$	F -tabulated		3.32
$\hat{\sigma}_1^2$	Estimated variance of period (>2015)		209,324.72
$\hat{\sigma}_2^2$	Estimated variance of period (<2015)		15,970.641
$F-VC$	F -calculated for differences in estimated variances		12.793

Source: Author's survey analysis using SPSS Version 18

The Weibull and Gama risk distribution versions of eq. (3) were used to calculate the implication of total costs of travel time for the FCT. The summary results are reported in Table 4.

Table 4: SPSS 18 summary results of Weibull distribution estimation costs of travel time for an individual per trip in FCT Before and After 2012

Variable	<u>Before August 2014</u>		<u>After August 2014</u>		<u>Pooled</u>	
	Unstand'd	Stand'd	Unstand'd	Stand'd	Unstand'd	Stand'd
T	9.290	0.797	10.895	0.648	12.878	0.920
SDE	25.697	0.093	34.232	0.122	19.537	0.063
SDL	-11.093	-0.462	-12.195	-0.297	-15.875	-0.498
D	472.746	0.443	428.262	0.421	396.981	0.376
R^2	0.852		0.854		0.859	
$D-W$	2.676		2.715		2.668	

Source: Author's survey analysis using SPSS Version 18

Table 5 summarizes the total costs of travel time for households intervened in the survey. It represents the total costs of travel time for the 393 households surveyed in the FCT.

Table 5: Total cost of daily travel time for all the individuals over the survey sample in FCT (Weibull and Gamma distributions)

Cost	<u>Before August 2014</u>	<u>After August 2014</u>	<u>Change in Total Cost of Travel Time</u>
EC^a	252,693	347,479.58	94,786.58
EC^b	-594.95	-779.39	-184.44
EC^c	-266.97	-3,755.06	-3,488.09
TEC	251,831.07	342,945.14	91,114.05

Source: Author's computation based survey data analysis

As shown in Table 6, the projected population of FCT as at 2017 was 3,912,307. The cosmopolitan nature of the FCT characterized by high concentration of residential houses, administrative status of capital city, wholesale and retail outlets as well as the quest to access basic utilities have attracted people from all parts of the country might be some of the variables responsible for the growing population of the FCT. As a matter of fact, the concentration of business activities and the high vehicular traffic levels might have 'conspired' with the mounting of military checkpoints to fuel the incessant reoccurrence of traffic congestion in the city at peak periods.

Table 6: Projected population of FCT by Area Council, 2008 – 2017

Area Council	2011*	2012†	2013†	2014†	2015†	2016	2017
Abaji	93,309	102,406.6	112,391.3	123,349.4	135,376	148,575.2	163,061.2

AMAC	1,235,877	1,356,375	1,488,622	1,633,762	1,793,054	1,967,877	2,159,745
Bwari	365,007	400,595.2	439,653.2	482,519.4	529,565	581,197.6	637,864.4
Gwagwalada	252,522	277,142.9	304,164.3	333,820.3	366,367.8	402,088.7	441,292.3
Kuje	154,796	169,888.6	186,452.7	204,631.9	224,583.5	246,480.4	270,512.2
Kwali	137,190	150,566	165,246.2	181,357.7	199,040.1	218,446.5	239,745
TOTAL	2,238,751	2,457,029	2,696,590	2,959,507	3,248,059	3,564,745	3,912,307

NB: * National Bureau of Statistics, 2012

† Projected at 9.75 per cent growth rate used by National Bureau of Statistics (2012) for the period 2012 - 2017.

Results obtained from the survey sample show that, with an average of 4.5 household members commuted to and fro the city centre between 2012 and 2017. Based on the sample survey, about 43.83 percent household members were estimated to have visited the city centre daily within the study period. Given the projected population figures in Table 6 and ₦91,114.05 (US \$253.097) per/week as the net total cost of individuals travel time (Table 5), effort was made extrapolate the expected total costs associated with travel time variability between 2012 and 2017. First the average daily total cost an individual incurred due to travel time variability was determined as ₦231.84 (US\$0.644). Finally, the estimated annual average cost of mounting military check points on the FCT highways for the year 2012 was between ₦178 (US\$0.4944) million and ₦2,276 (US\$6.3222) million. In 2017, it rose to between ₦283 (US\$0.786) million and ₦3,624 (US\$90.6068) million. The total expected cost for the six years under study was ₦733.068 (US\$2.036) billion, meaning that within six years of mounting military checkpoint on three arterial highways, the local economy of FCT might have lost in excess of ₦700 (US\$1.9) billion.

Table 7: Estimated total expected costs of travel time variability due to military checkpoint in the FCT (2015-2017)

Statistic	2012	2013	2014	2015	2016	2017
<i>Projected population of FCT ('000)</i>	2,457.0	2,696.6	2,959.5	3,248.	3,564.8	3,912.
				1		3
<i>Total number of household members who commuted to city centre ('000)</i>	1,101.5	1,208.9	1,326.8	1,456.	1,598.1	1,753.
				1		9
<i>Mean total expected cost of travel time variability (TEC) in the FCT (₦million)</i>	1,137.3	1,248.2	1,369.9	1,503.	1,650.1	1,811.
				5		0
<i>Lower bound of mean TEC (₦million)</i>	177.9	195.3	214.4	235.3	258.2	283.4
<i>Upper bound of mean TEC (₦million)</i>	2,275.7	2,497.6	2,741.1	3,008.	3,301.7	3,623.
				4		6
<i>Total monthly TEC (₦million)</i>	7,961.4	8,737.6	9,589.6	10,500	11,600	12,700
<i>Total annual TEC (₦million)</i>	95,536.	104,851.	115,075	126,00	139,200	152,40
	8	2	2	0		0

CONCLUDING REMARKS

This study shows that the mounting military checkpoints on the FCT highways between 2012 and 2017 may have affected the economy of FCT adversely. For the period under study (2012 - 2017), the FCT economy may have lost over ₦730 billion to traffic congestion occasioned by the mounting of military checkpoint.

Any measure to minimize the significant negative externalities of increased traffic congestion on express motorways in FCT, and indeed Nigeria, must recognize the need to reduce commuters' travel time variability. In view of this, the following are recommended:

- a. There is the need to develop and deploy new approach to achieving security checking at checkpoint without unnecessarily creating more traffic congestion by security agencies, especially the military. In this regard, newer and modern surveillance technologies (radars, remote scanners and cameras) should be considered at such checkpoints. Also security and in particular military operatives should be trained in modern surveillance techniques.

- b. Alternative modes of transport should be considered so as to reduce the pressure on the major arteries leading to the city centre, such as intra-city train and/ tram systems.
- c. As this and other studies on commuters' travel time have shown, there is the need to integrate such studies in the environmental assessment process associated with road/transport planning and implementation by federal and state transport authorities. Such economic valuation of road/transport projects can serve as early warning systems as well as provide alternative measures in addressing increased traffic congestion whenever there is the need to mount such in the event of security challenges such as the one currently experienced by Nigeria.

References

- Alcantara de Vasconcellos, E. (2005). Urban change, mobility and transport in Sao Paulo: three decades, three cities. *Transport Policy*, 12(2), p.91-104.
- Bates, J., Polak, J., Jones, P. and Cook, A. (2001). The valuation of reliability for personal travel. *Transportation Research Part E: Logistics and Transportation Review*, 37(2): 191-229.
- Beaud, M., Blayac, T. and Stephen, M. (2016). The impact of travel time variability and traveler's risk attitudes on the values of time and reliability. *Transport Research Part B*, 93:207-224.
- Becker, G. (1965). A theory of the allocation of time. *The Economic Journal*, 75, 493-517.
- Biliyamin, I. A. and Abosede, B. A. (2012). Effects of congestion and travel time variability along Abuja-Keffi corridor in Nigeria. *Global Journal of Research In Engineering*, 12(3-E).
- Börjesson, M., and Eliasson, J. (2010). The value of time and external benefits in bicycle cost-benefit analyses. *Selected proceedings of the 12th WCTR*.
- Börjesson, M., Fosgerau, M. and Algers, S. (2009). The income elasticity of the value of travel time is not one number. In *European Transport Conference, 2009. Leiden Leeuwenhorst Conference Centre, Netherlands. 2009-10-5 to 2009-10-7*.
- Buchel, B. and Carman, F. (2018). Modelling probability distributions of public travel time components. 18th Swiss Transport Research Conference Monte Verita/Ascona, May 16-18, 2018.
- Chow, G.C. (1960). Tests of equality between sets of coefficients in two linear regressions. *Econometrica*, 28(3): 591-605.
- De Borger, B., and Fosgerau, M. (2006, August). Another test of the theory of reference-dependent preferences: the trade-off between money and time. In: European Transport Conference proceedings.
- De Borger, B., and Fosgerau, M. (2008). The trade-off between money and travel time: A test of the theory of reference-dependent preferences. *Journal of Urban Economics*, 64(1), 101-115.
- De Serpa, A. (1971). A theory of the economics of time. *The Economic Journal*, 81, 828-846.
- Evans, A. (1972). On the theory of the valuation of travel time savings. *Scottish journal of Political economy*, 19:1-17.
- FMI (2004). FMI 3-07.22: Counterinsurgency operations. October, 2004 (expires 1 October, 2006). Appendix C. *Population and resources control*. Available: www.GlobalSecurity.org. Accessed: 14/12/2016.
- Gujarati, D.N. and Porter, D.C. (2009). *Basic econometrics* 5th edition. Boston: McGraw-Hill.
- Jara-Díaz, S.R. (2000). "Allocation and valuation of travel time savings." *Handbook in Transport* 1(2000): 303-319.
- Johnson, M. (1966). Travel time and price of leisure. *Western economic journal* 4:135-145.
- Koster, P., Kroes, E., and Verhoef, E. (2008). Valuing the cost of car travel time variability. Working paper, VU University, Amsterdam, September, earlier version presented at the *Kuhmo Necter Conference*, Amsterdam, 2008
- Koster, P., Kroes, E., and Verhoef, E. (2011). Travel time variability and airport accessibility. *Transportation Research Part B: Methodological*, 45(10), 1545-1559.
- Mazloumi, E., Currie, G. and Rose, G. (2010). Using GPS data to gain insight into public transport travel time variability. *Journal of Transportation Engineering*, 136 (7): 623-631.
- McKnight, C.E., Levison, H.S., Ozkay, Kamga, K.C. and Paaswell, R.E. (2004). Impact of traffic congestion on bus travel time in northern New Jersey. *Transportation Research Record*. Available: www.citeseerx.ist.psu.edu. Access: 30/08/2017.
- Federal capital Territory Administration/Nigerian Institute of Transport Technology (FCTA/NITT, 2009). Final report on Abuja traffic and ridership survey. (Unpublished report)
- National Bureau of Statistics (NBS, 2012). *Annual abstract of statistics*. Abuja: National Bureau of Statistics.
- Noland, R. B. and K. A. Small (1995). Travel time uncertainty, departure time choice and the cost of morning commutes. *Transportation Research Record*, 1493, 150-158.

- Olatunde, R.A (2016). Impact of traffic congestion on commuter's travel time in Lagos state. A thesis of the department of economics, Nigerian Defence Academy Kaduna.
- Oort, O. (1969). The evaluation of travelling time. *Journal of Transport Economics and Policy*, 3:279-286.
- Small, K. (1982). Scheduling of consumer activities work trip. *America Economic Review* 72:467-479.
- Srinivasan, S., and Rogers, P. (2005). Travel behavior of low-income residents: studying two contrasting locations in the city of Chennai, India. *Journal of Transport Geography*, 13(3), 265-274.
- Tagaris, E. Liao, K.J., Delucia, A.J., Deck, L., Amar, P. and Russell, A.G. (2009). Potential impact of climate change on air pollution-related human health effects. *Environmental Science Technology* 1, 43(13): 4979-88.
- Umaru, I.G. (2013). *Research methodology: Principles and application in social and behavioral science*. Jos, Nigeria: Olive de L'Afrique Consult/Eiwa Ventures
- van Oort, N., Sparing, D., Brands, T. and Goverde, R.M.P. (2015). Data driven improvements in public transport: The Dutch example. *Public Transport*, 7(3): 369-389.
- Wajek, M. and Hauger, G. (2017). Reliability of travel time: Challenges posed by a multimodal transport participation. *IOP Guf. Series: Materials Science and Engineering*, 245 (2017).
- Yamane, T. (1964). *Statistics: An introductory analysis* 3rd edition. New York: Harpen and Row Publishing.

Appendix

In case of the exponential distribution with mean $pdf = \frac{1}{k} e^{-\left(\frac{T}{k}\right)}$ and standard deviation k it is possible to evaluate the integrals of EC^α and EC^β :

$$EC^\alpha = \int_0^{\infty} \alpha * T * f(T) dT = \alpha * E(T) = \alpha * k \quad (6)$$

$$\begin{aligned} EC^\beta &= \int_0^{PAT-t_h} \beta * (PAT - t_h) f(T) dT = \beta * (PAT - T - t_h) * \left[\frac{1}{k} * e^{-\left(\frac{-T}{k}\right)} \right] dT \\ &= \beta * \left[k * \left(-1 + e^{-\frac{PAT+t_h}{k}} \right) + PAT - t_h \right] \end{aligned} \quad (7)$$

$$\begin{aligned} EC^\gamma &= \int_{PAT-t_h}^{\infty} \gamma * (T + t_h - PAT) f(T) dT \\ &= \gamma * k * e^{-\frac{PAT+t_h}{k}} \end{aligned} \quad (8)$$

and the optimal travel cost determined as:

$$\begin{aligned} \frac{\partial TEC}{\partial t_h} &= -\beta + (\beta + \gamma) * e^{-\frac{PAT+t_h}{k}} = 0 \Rightarrow \frac{\beta}{\beta + \gamma} = e^{-\left(\frac{PAT-t_h}{k}\right)} \\ t_h^* &= PAT - k * \ln \left[\frac{\beta + \gamma}{\beta} \right] \\ TEC^* &= \alpha * k + \beta * k * \ln \left[\frac{\beta + \gamma}{\beta} \right] \end{aligned} \quad (9)$$

To estimate travel time with the Weibull distribution, the different parts of the total costs are as follows:

$$EC^\alpha = \int_0^{\infty} \alpha * T * f(T) dT = \alpha * \left[\lambda * Gamma \left[1 + \frac{1}{k} \right] \right] \quad (10)$$

$$EC^\beta = \beta * (PAT - t_h) * F(PAT - t_h) - \beta * \left\{ E(T) - Gamma \left[1 + \frac{1}{k}, \left(\frac{PAT - t_h}{\lambda} \right)^k \right] \right\} \quad (11)$$

$$EC^\gamma = \gamma * (t_h - PAT) * [1 - F(PAT - t_h)] + \gamma * E(T) * Gamma \left[1 + \frac{1}{k}, \left(\frac{PAT - t_h}{\lambda} \right)^k \right] \quad (12)$$

Setting the first derivative of the total expected costs to zero we obtain the condition:

$$\frac{\partial TEC}{\partial t} = e^{-\left(\frac{PAT-t_h}{\lambda}\right)^k} * \left\{ \left[1 - e^{-\left(\frac{PAT-t_h}{\lambda}\right)^k} \right] * \beta + \gamma \right\} = 0 \quad (13)$$

$$t_h^* = PAT - \lambda * \left(\log \left[\frac{\beta + \gamma}{\beta} \right] \right)^{\frac{1}{k}}$$

Should the empirical distribution to fit empirical travel time data turned out to be gamma distribution, the three parts of the expected total costs function to estimate are:

$$EC^\alpha = \alpha * E(T) = \alpha * k * \theta \quad (14)$$

$$\begin{aligned}
 EC^\beta &= \beta * (PAT - t_h) * [1 - F(PAT - t_h)] - \beta * \left[E(T) - \int_{PAT-t_h}^{\infty} T * f(t) dT \right] \\
 &= \beta * (PAT - t_h) * [1 - F(PAT - t_h)] - \beta * \left\{ E(T) - \frac{\theta * \text{Gamma} \left[1 + k, \frac{PAT - t_h}{\theta} \right]}{\text{Gamma}[k]} \right\}
 \end{aligned} \tag{15}$$

where Gamma[a, b] is the incomplete gamma function. The costs for being late are derived:

$$EC^\gamma = \gamma * (t_h - PAT) * [1 - F(PAT - t_h)] + \gamma * \int T * f(T) dT \tag{16}$$

$$\gamma * (t_h - PAT) * [1 - F(PAT - t_h)] + \gamma * \left\{ \frac{\theta * \text{Gamma} \left[1 + k, \frac{PAT - t_h}{\theta} \right]}{\text{Gamma}[k]} \right\} \tag{17}$$

If the first derivative is set to zero, the following will result:

$$\frac{\partial TEC}{\partial t} \frac{\beta}{\gamma + \beta} = \frac{\text{Gamma} \left[k, \frac{PAT - t_h}{\theta} \right]}{\text{Gamma}[k]} = Q \left[k, \frac{PAT - t_h}{\theta} \right] \tag{18}$$

The three parts of the total cost function for the Lognormal distribution are:

$$EC^\alpha = \int \alpha * T * f(T) dT = \alpha * [E(T)] = \alpha * \left[e^{\mu + \frac{\sigma^2}{2}} \right] \tag{19}$$

$$EC^\beta = \beta * (PAT - t_h) * F(PAT - t_h) - \beta * E(T) * E(T) * (1 - \Theta[R(PAT - t_h)]) \tag{20}$$

$$EC^\gamma = \gamma * (t_h - PAT) * [1 - F(PAT - t_h)] + \gamma * E(T) * \Theta[R(PAT - t_h)] \tag{21}$$

where F(.) is the cumulative lognormal probability and E(T) the expectation. Setting the first derivative of the total costs function to zero yields the optimal t_h :

$$\frac{\partial TEC}{\partial t_h} = (\beta + \gamma) * \left[-F(.) + (PAT - t_h) * \frac{\partial F(.)}{\partial t_h} + E(T) * \frac{\partial \Theta(.)}{\partial t_h} \right] + \gamma = 0$$

so

$$\frac{\gamma}{\gamma + \beta} = F(PAT - t_h) + \left[(PAT - t_h) * f(PAT - t_h) - E(T) * g(PAT - t_h) * \left[\frac{1}{\sigma(PAT - t_h)} \right] \right] \tag{22}$$

where F(.) is the cumulative distribution of the lognormal in $PAT - t_h$, f(.) is the probability of the lognormal in $PAT - t_h$, g(.) is the standard normal probability evaluated at $PAT - t_h$.



Leadership: A Comprehensive Review of Literature, Research and Theoretical Framework

Sait Revda Dinibutun¹

¹ Assistant Professor of HRM, College of Business Administration, American University of the Middle East, Kuwait

Correspondence: Sait Revda Dinibutun, College of Business Administration, American University of the Middle East, Dasman, 15453, Kuwait. Tel: +965 2225 1400/1576. E-mail: sait.revda@aum.edu.kw

Abstract

This paper provides a comprehensive literature review on the research and theoretical framework of leadership. The author illuminates the historical foundation of leadership theories and then clarifies modern leadership approaches. After a brief introduction on leadership and its definition, the paper mentions the trait theories, summarizes the still predominant behavioral approaches, gives insights about the contingency theories and finally touches the latest contemporary leadership theories. The overall aim of the paper is to give a brief understanding of how effective leadership can be achieved throughout the organization by exploring many different theories of leadership, and to present leadership as a basic way of achieving individual and organizational goals. The paper is hoped to be an important resource for the academics and researchers who would like to study on the leadership field.

Keywords: Behavioral Approach, Contemporary Theories, Contingency Theories, Leadership, Servant Leadership, Trait Theories, Transactional Leadership, Transformational Leadership

1. Introduction

In order to attain organizational effectiveness, organizations have shifted away from the use of hierarchical structures and individualized jobs, and implemented team-based work structures. This implementation has increased the importance of individual initiative and cooperation (Le Pine, Erez, & Johnson, 2002). Therefore, in today's complex business world, one of the major concerns of organizations is motivating employees for initiative and cooperation in order to attain effective organizational functioning (Le Pine et al., 2002).

The concept of leadership has evolved and developed due to numerous organizational and environmental changes (Alonderiene & Majauskaitė, 2016). Several studies have been carried out to assess the effect of leadership on the performance of organizations and how organizational variables such as culture, employee effectiveness, satisfaction, performance, retention, and motivation are influenced by various leadership styles (Shaw & Newton, 2014; Siddique, Aslam, Khan, & Fatima, 2011; Yang, 2014; Yang & Islam, 2012).

The literature is very rich with theories about leadership in general. It has been a major topic of research in psychology, which has spawned thousands of empirical and conceptual studies (Zaccaro & Klimoski, 2001). According to Yukl's (1989) study, most leadership researches suggest that leadership is an important determinant of organizational effectiveness. Leaders can significantly affect individual, group, and organizational performance (Ilies, Nahrgang, & Morgeson, 2007). Effective leaders influence individuals and groups so that they are willing to perform beyond the minimum levels required by the organization (Ilies et al., 2007; Podsakoff, MacKenzie, Moorman, & Fetter, 1990).

This paper aims to give a brief and clear understanding of leadership and theories of leadership in order to form the most effective leadership type.

2. Definition of Leadership

Leadership is mostly defined as the process of influencing a group toward the achievement of goals and directing the organization to make it more cohesive and coherent (Bass, 1997). A leader carries out such a process by applying his/her leadership qualities, such as values, beliefs, character, knowledge, skills, ethics, experience, and culture. Leaders inspire people, move them to action and change the world. Leadership is a social process that is highly complex.

Leadership includes influence processes involving determination of the group's objectives, motivating task behavior in pursuit of these objectives, and influencing group maintenance and culture (Yukl, 1989). Burns (1978) defined leadership as: "inducing followers to act for certain goals that represent the values and the motivations, the wants and needs, the aspirations and expectations of both leaders and followers." Table 1 summarizes the defining statements on leadership by researchers, which cover more than one century of academic work on the subject.

Table 1: Definitions of Leadership

Researchers	Definition of Leadership
Blackmar (1911)	It is the centralization of effort in one person.
Bernard (1927)	It focuses the attention of group members into the desired direction.
Copeland (1942)	It is the art of influencing.
Knickerbocker (1948)	It consists of a relationship between an individual and a group.
Stogdill (1950)	It is the process of influencing the activities of an organized group in its effort toward goal setting and goal achievement.
Bennis (1959)	It induces a subordinate to behave in a desired manner.
Bass (1961)	It is an individual's effort to change the behavior of others.
Tannenbaum (1961)	It is interpersonal influence toward the attainment of a specified goal or goals.
Katz and Kahn (1966)	It is an influential increment over and above compliance with the routine directives of the organization.
Burns (1978)	It transforms followers, creates visions of the goals that may be attained and articulates for the followers ways to attain those goals. Leadership persons mobilize resources to arouse, engage and satisfy the motives of followers.
Pondy (1989)	It is a form of social influence.
Schein (1992)	It is the ability to start evolutionary change processes that are more adaptive.
Bass (1994)	It is an interaction and leaders are agents of change whose acts affect other people more than people's acts affect them.
Drucker (1998)	It needs a leader. The only definition of a leader is someone who has followers.
Vroom and Jago (2007)	It refers to a potential or capacity to influence others.
Jung (2013)	It is the alignment of subordinates' activities and their motivational activation for goal attainment.

Source: Self-created

Review of the literature reveals three primary components to any leadership situation bound together by a concept of dynamic interaction between: the leader; the follower(s); and the context, environment, or situational aspect of their surroundings. The capable leader is one who knows how to capitalize on the potentialities inherent in his or her own personality, his or her subordinates, and the situation. From this perspective, leadership can be viewed as the ability to involve others in the process of accomplishing a goal within some larger system or environment.

3. Leadership Theories

Leadership is a social phenomenon that is found everywhere. People always are attracted by legends and myths about what distinguishes great leaders from followers (Den Hartog & Koopman, 2001).

Several main trends can be discernible in the development of the study of leadership. While early theories tend to focus on the characteristics and behaviors of successful leaders, later theories begin to consider the role of followers and contextual nature of leadership (Bolden, Gosling, Marturano, & Dennison, 2003).

Over the years there have been a number of theories addressing the understanding of leadership, including great man theory, trait theory of leadership, behavioral theories, contingency theories, and contemporary leadership theories as charismatic leadership, transformational leadership, transactional leadership, and servant leadership theory.

3.1. Great Man Theory and Trait Theory

The Great Man approach is a leadership perspective that sought to identify the inherited traits leaders possessed that distinguished them from people who were not leaders (Daft, 2018). It assumes that the capacity for leadership is inherent – that great leaders are born, not made. The term ‘Great Man’ was used because leadership was conceptualized as a single ‘Great Man’ who put everything together and influenced others to follow along based on inherited traits, qualities, and abilities.

Trait theory assumes that people inherit certain qualities and traits that make them better suited to leadership. Traits are the distinguishing personal characteristics of a leader, such as intelligence, honesty, self-confidence, and appearance (Daft, 2018). A large number of personal traits and abilities have been associated with successful leaders, but traits themselves are not sufficient to guarantee effective leadership. Natural traits and behavior patterns can be developed into strengths. It is important for leaders to recognize their strengths and acknowledge the interdependence that is a key to effective leadership.

Trait research has been part of leadership studies conducted since the 1940s. Findings suggest that some traits are essential to effective leadership when other factors are present. Table 2 presents some of the traits and their respective categories that have been identified through trait research over the years.

Table 2: Studies of Leadership Traits and Characteristics

Stogdill (1948)	Mann (1959)	Stogdill (1974)	Lord, DeVader and Alliger (1986)	Kirkpatrick and Locke (1991)
Intelligence	Intelligence	Achievement	Intelligence	Drive
Alertness	Masculinity	Persistence	Masculinity	Motivation
Insight	Adjustment	Insight	Dominance	Integrity
Responsibility	Dominance	Initiative		Confidence
Initiative	Extroversion	Self-confidence		Cognitive Ability
Persistence	Conservatism	Responsibility		Task Knowledge
Self-confidence		Cooperativeness		
Sociability		Tolerance		
		Influence		
		Sociability		

Source: *Leadership: Theory and Practice*, P.G., Northouse. 2004, Oaks: Sage Publications, Inc.

Researchers who pursue a trait approach to leadership assume that leaders are different from other people, and that there must be some deeper traits which cause some people to become leaders (Hampton, Summer, & Webber, 1978). The general approach was to compare leaders to non-leaders to see what differences existed with respect to different kinds of traits. The theory seemed valid for a time, but when it was recognized that leaders who didn't have those traits could always be found, another group of researchers began to concentrate on the behaviors of leaders.

3.2. Behavioral Theories

After World War II, research emphasis shifted from personality traits to a search for behavior that makes a difference in the performance or satisfaction of followers. Contrary to trait theories, leadership was viewed as an observable, personal characteristic. The theories developed at that time were called '*behavioral theories*' as they emphasized the leader's behavior. According to this theory, people can learn to become leaders through teaching and observation. As Den Hartog and Koopman (2001) stated, the focus shifted from whom leaders are to what leaders do.

Behavioral theories' main theme is that leaders become successful and effective according to what they actually do – *behaviors* – when they are dealing with subordinates. Researchers focused on understanding the relationship between how the leaders behave and how the subordinates react emotionally – i.e. satisfaction – and behaviorally – i.e. performance (Feldman & Arnold, 1983). As an outcome of these studies, a variety of leadership styles are determined. The studies which are involved in behavioral approach are; University of Iowa Studies, Ohio State University Studies, University of Michigan Studies and University of Texas Study – The Leadership Grid.

3.2.1. Autocratic versus Democratic Behaviors

Autocratic is a leader who tends to centralize authority and derives power from position, control of rewards, and coercion, whereas *Democratic* is a leader who delegates authority to others, encourages participation, relies on subordinates' knowledge for completion of tasks, and depends on subordinate respect for influence (Daft, 2018).

3.2.2. University of Iowa Studies

The first studies on autocratic versus democratic leadership behaviors were conducted at the University of Iowa by Kurt Lewin (1939). The research included groups of children, each with their own designated adult leader who was instructed to act in either an autocratic or a democratic style.

Studies showed that the groups with autocratic leaders performed well when the leader supervised them. However, group members were displeased with the autocratic style of leadership, and feelings of hostility arose. Groups assigned to democratic leaders performed almost as good, and these groups were characterized by positive feelings rather than hostility. In addition, under the democratic style of leadership, group members performed well even when the leader was absent. Participative techniques and majority-rule decision-making used by the democratic leader trained and involved the group members to perform well with or without the leader present. The University of Iowa studies found that leadership behavior had a definite effect on follower performance and satisfaction.

This early work implied that leaders were either autocratic or democratic in their approach. Further work by Tannenbaum and Schmidt (1973) indicated that leadership behavior could exist on a continuum reflecting different amounts of employee participation. Thus, one leader might be autocratic (boss-centered), another democratic (subordinate-centered), and a third a mix of the two styles, as shown in Figure 1 (Tannenbaum & Schmidt, 1973).

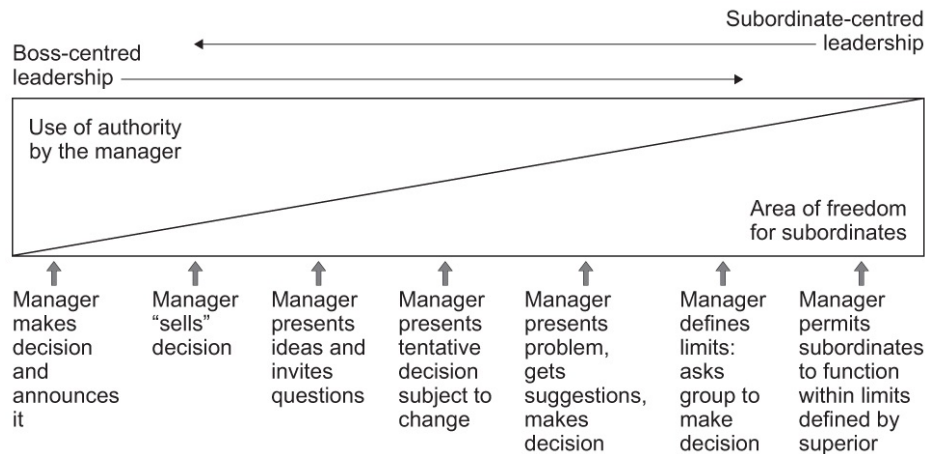

Figure 1: Leadership Continuum

Source: Harvard Business Review. An exhibit from Robert Tannenbaum and Warren Schmidt, "How to Choose a Leadership Pattern" (May–June 1973).

Tannenbaum and Schmidt (1973) suggested that the extent to which leaders should be autocratic or democratic depended on organizational circumstances and that leaders might adjust their behaviors to fit the circumstances. For example, if it takes too long for subordinates to make decisions, the leader will use an autocratic style. If subordinates can learn decision-making skills readily, a democratic style can be used. Also, the greater the skill difference, the more autocratic the leader approach, because it is difficult to bring subordinates up to the leader's expertise level (Heller & Yukl, 1969).

3.2.3. Ohio State University Studies

The Ohio State University Leadership Studies focused on how leaders could satisfy common group needs (Daft, 2018). As a result, two important dimensions of leader behavior were identified; *consideration* and *initiating structure*. Consideration is the extent to which a leader is sensitive to subordinates, respects their ideas and feelings, and establishes mutual trust. A leader who is high in consideration helps group members with personal problems, is friendly and approachable, and treats all group members as equals (Yukl, 1989). Initiating Structure is the extent to which a leader is task-oriented and directs subordinates' work activities toward goal achievement. A leader who is high in initiating structure directs tasks, plans, and rules with an iron hand (Bass, 1990).

The studies found that a leader who was high in both initiating structure and consideration – a *high-high leader* – achieved high group task performance and satisfaction more frequently than one who rated low on either dimension or both. In the studies of Ohio State University, a questionnaire was developed which was called Leader Behavior Description Questionnaire (LBDQ) (Hemphill & Coons, 1957).

3.2.4. University of Michigan Studies

The studies directly compared the behavior of effective and ineffective supervisors. The effectiveness of leaders was determined by productivity of the subordinate group (Daft, 2018). Two types of leadership behavior were established: *employee-centered* and *job-centered*. Employee-centered is a leadership behavior that displays a focus on the human needs of subordinates. It deals with each employee, thinking that every employee is important and has personal needs. Job-centered is a leadership behavior in which leaders direct activities toward efficiency, cost-cutting, and scheduling, with an emphasis on goals and work facilitation. It focuses mostly on production and technical subjects, and it sees employees as tools for reaching company goals (Blanchard, Spears, & Lawrence, 2001).

The Michigan University researchers concluded that the employee-centered leaders were more effective as they were associated with high group productivity and high job satisfaction (Robbins & Coulter, 2005). Unlike Ohio State University Studies, according to Michigan Studies, leaders could be employee-centered or job-centered, but not both. Performance was also influenced by other factors related to the situation.

3.2.5. University of Texas Study – The Leadership Grid

The Leadership Grid Model developed by Robert Blake and Jane Mouton (1985), from the University of Texas, is famous for its explanations about organizational leadership. This model focuses on two dimensions of the leader's behaviors, namely *concern for people* and *concern for production*. Concern for people is the degree to which a leader considers the needs of team members, their interests, and areas of personal development when deciding how best to accomplish a task. Concern for production is the degree to which a leader emphasizes concrete objectives, organizational efficiency and high productivity when deciding how best to accomplish a task (Blake & Mouton, 1985).

The model identifies five different leadership styles based on the concern for people and the concern for production. The model is represented as a grid with concern for production as the X-axis and concern for people as the Y-axis; each axis ranges from 1 (Low) to 9 (High). The grid is shown in Figure 2.

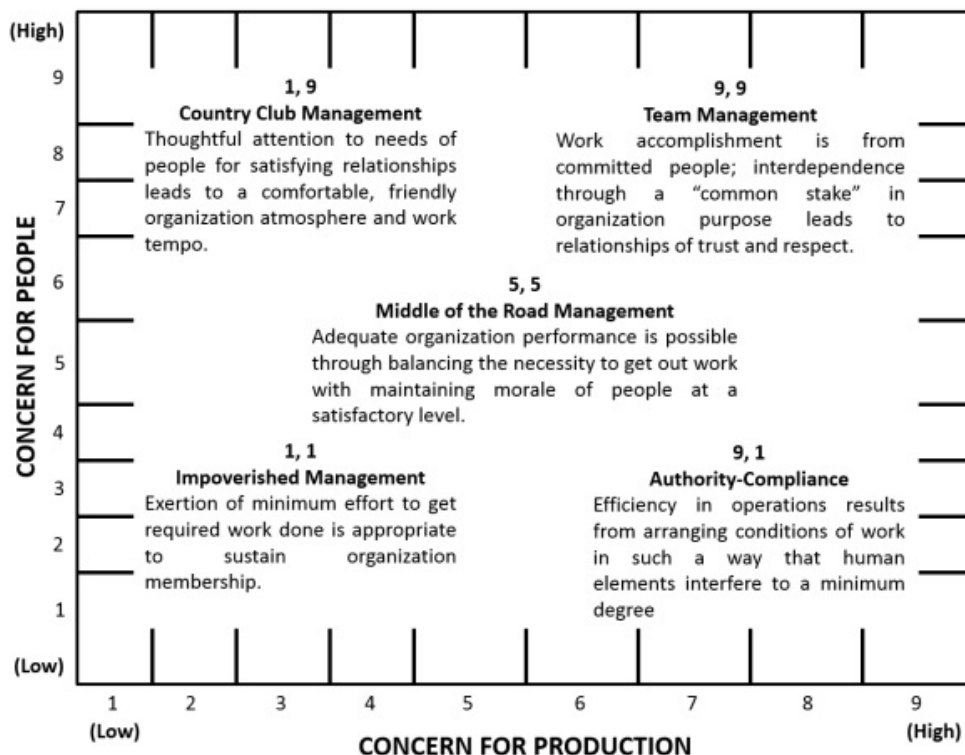

Figure 2: The Leadership Grid

Source: *The Leadership Grid figure from Leadership Dilemmas—Grid Solutions by Robert R. Blake and Anne Adams McCanse. Houston: Gulf Publishing Company, p. 29, (1991).*

Five leadership styles are briefly described as follows (Blake & Mouton, 1985):

- *Team Management* (9,9): Members work together to accomplish tasks. It's considered the best style.
- *Country Club Management* (1,9): Emphasis is given to people rather than to work outputs.
- *Authority-Compliance Management* (9,1): Efficiency in operations is the dominant orientation.
- *Middle-of-the-Road Management* (5,5): A moderate amount of concern is shown for both people and production.
- *Impoverished Management* (1,1): Leaders exert little effort.

Blake and Mouton (1985) suggested that the way to reach effective leadership is integrating task-oriented and people-oriented behaviors.

The research about the behavior approach concluded in two dominant types of leadership behaviors; people-oriented and task-oriented. The behavior types as a result of the studies are summarized in Table 3.

Table 3: Themes of Leader Behavior Research

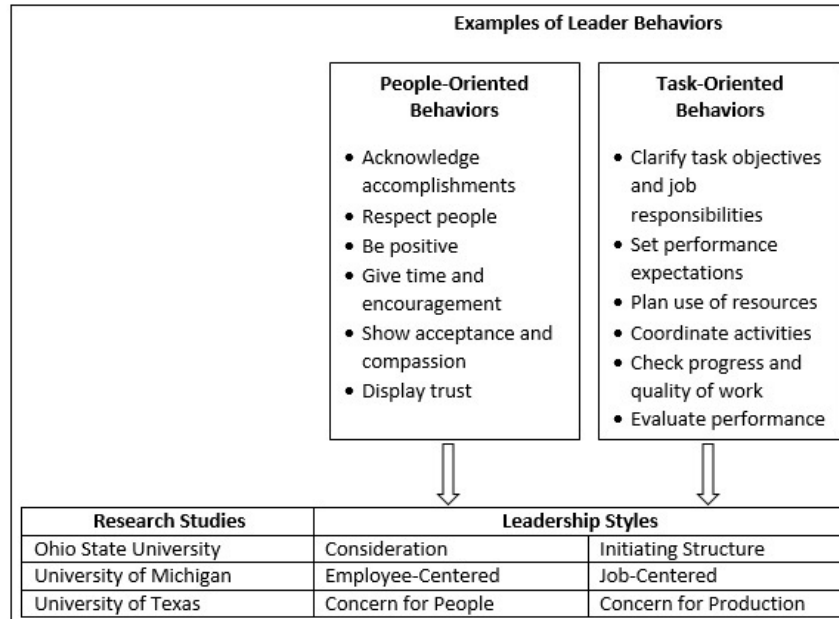

Source: *The Leadership Experience*, by Richard L. Daft, 7th Edition, Cengage Learning, (2018).

The behavior approach explored autocratic versus democratic leadership, consideration versus initiating structure, employee-centered versus job-centered leadership, and concern for people versus concern for production. These are fundamental behaviors through which leaders meet followers' needs.

3.3. Contingency (Situational) Theories

In the late 1960s, the importance of situation on the relationship between leadership style and effectiveness began to hold a great place in researches. The general assumption of the situational approach is that different situations require different leadership styles. Leaders should select a style that best fits with the situation at a given time (Gordon, 1996). This is a very practical approach because it suggests different leadership styles to different situations. Well-known theories of situational approach include: Fiedler's Contingency Model of Leadership (1967), Hersey and Blanchard's Situational Leadership Theory (1969), House's Path-Goal Theory (1971) and Vroom, Yetton, and Jago's Contingency Model (1973).

3.3.1. Fiedler's Contingency Model of Leadership

Fiedler (1967) developed the 'Contingency Model of Leadership' and defined two leadership styles: '*relationship-oriented*' and '*task-oriented*' which were again similar to consideration and initiating structure, respectively. Relationship-oriented leaders are concerned with developing good relations with their subordinates and to be liked by them. Task-oriented leaders' primary concern is to ensure that subordinates perform at a high level so the job gets done. They provide clear directions and sets performance standards.

Fiedler measures an individual's leadership style through the LPC (Least Preferred Co-worker Questionnaire). It measures the leadership style by having the leader describe a coworker with whom he/she had difficulty completing a job; not necessarily someone disliked, but someone with whom they least liked to work. After the person is chosen, the LPC instrument asks the leader to describe the coworker on a set of adjectives. The adjectives the leader chooses to describe the LPC determine if the leader is task-oriented or relationship-oriented. Examples of the adjectives used by Fiedler (1967) on the LPC scale are as follows:

- *open* *guarded*
- *quarrelsome* *harmonious*
- *efficient* *inefficient*
- *self-assured* *hesitant*

- *gloomy* *cheerful*

According to LPC scale, the leader who describes the least preferred co-worker in positive terms is relationship-oriented; and the leader who describes the least preferred co-worker in negative terms is task-oriented (Fiedler, 1967).

After assessing the leadership style through LPC, it is essential to evaluate the situation to match the leader with the situation. Leadership styles' effectiveness depends on the favorability of the situation as defined by three contingencies (Fiedler, 1967):

- *Leader-Member Relations* – quality of interpersonal relationships among a leader and group members. The extent to which followers like, trust, and are loyal to their leader
- *Task Structure* – degree of clarity or ambiguity in the group's work activities
- *Position Power* – the authority of the leader to reward and punish his/her subordinates.

A *favorable* situation will occur if leader-member relations are good, task structure is high and position power is strong; a *moderate* situation will occur if some of the three elements are high and others low; an *unfavorable* situation will occur if leader-member relations are poor, task structure is low and position power is weak (Fiedler, 1967). He suggested that, in very favorable and very unfavorable situations, the task-oriented leader would be effective, and in moderately favorable situations, the relationship-oriented leader. If the leader did not fit the situation, then the situation should have been changed by modifying these three contingencies (Den Hartog & Koopman, 2001).

3.3.2. Hersey and Blanchard's Situational Leadership Theory

Hersey and Blanchard's (1969) extension of the Leadership Grid focuses on the characteristics of followers as the most important element of the situation and, consequently, on determining effective leader behavior. There were two key leadership dimensions that Fiedler (1967) identified previously: task and relationship behaviors. In the situational leadership model, Hersey and Blanchard (1969) added the *readiness* to the task and relationship behaviors. The model explains the relationship between the followers' readiness and the effective leadership style.

The readiness level of the followers was defined as their ability and willingness to function (Hersey & Blanchard, 1969). People tend to have varying degrees of readiness, depending on the particular task or goal that a leader tries to accomplish. The model shows that the readiness levels of a leader's subordinates play a major role in determining which leadership styles are best suited. People low in readiness need a different leadership style than those who are high in readiness.

According to the situational theory, a leader can adopt one of four leadership styles, based on a combination of relationship (concern for people) and task (concern for production) behavior. The appropriate style depends on the readiness level of followers, as shown in Figure 3.

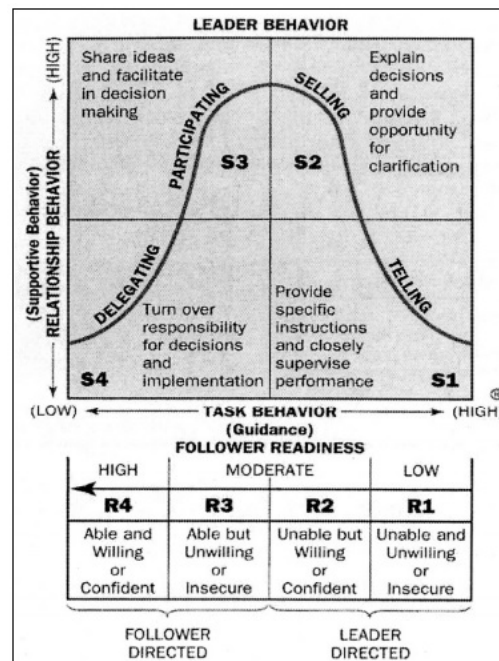

Figure 3: Hersey and Blanchard's Situational Leadership Model

Source: Hersey, P., Blanchard, K. H., (1993), *Management of Organizational Behavior – Utilizing Human Resources*, 6th Edition, Prentice-Hall International, New Jersey.

There are four stages of follower readiness (Hersey & Blanchard, 1993):

- **R1:** People are both unable and unwilling to take responsibility for doing something. They are neither competent nor confident.
- **R2:** People are unable but willing to do the necessary job tasks. They are motivated, but currently lack the appropriate skills.
- **R3:** People are able but unwilling to do what the leader wants.
- **R4:** People are both able and willing to do what is asked for them.

Task and relationship behaviors are considered as high or low and combined into four specific leadership styles (Hersey & Blanchard, 1993):

- **Telling (high task – low relationship):** The leader defines roles and tells people what, how, when, and where to do various tasks.
- **Selling (high task – high relationship):** The leader provides both directive and supportive behavior.
- **Participating (low task – high relationship):** the leader and follower share in decision-making; the main role of the leader is facilitating and communicating.
- **Delegating (low task – low relationship):** The leader provides little direction or support.

Matching the follower readiness with appropriate leader style is shown in Table 4.

Table 4: Hersey and Blanchard's Leadership Styles

Follower Readiness	Appropriate Leader Style
Low readiness level – R1	Telling (high task – low relationship)
Moderate readiness level – R2	Selling (high task – high relationship)
High readiness level – R3	Participating (low task – high relationship)
Very high readiness level – R4	Delegating (low task – low relationship)

Source: self-created in reference to Hersey, P., Blanchard, K. H., (1993), *Management of Organizational Behavior – Utilizing Human Resources*, 6th Edition, Prentice-Hall International, New Jersey

3.3.3. House's Path–Goal Theory

The most supported and influential contingency theory to date is probably House's Path-Goal Theory of Leadership, developed in 1971. The theory describes how the behavior of a leader influences the satisfaction and performance of subordinates (Yukl, 1989). According to the theory, the duty of the leader is to clean the road for the employees and get rid of problems on the way leading to defined goals, so the employees can function more efficiently (Den Hartog & Koopman, 2001). In particular, as seen in Figure 4, leaders increase follower motivation either by (House 1971):

- *clarifying the follower's path to the rewards that are available, or*
- *increasing the rewards that the follower values and desires.*

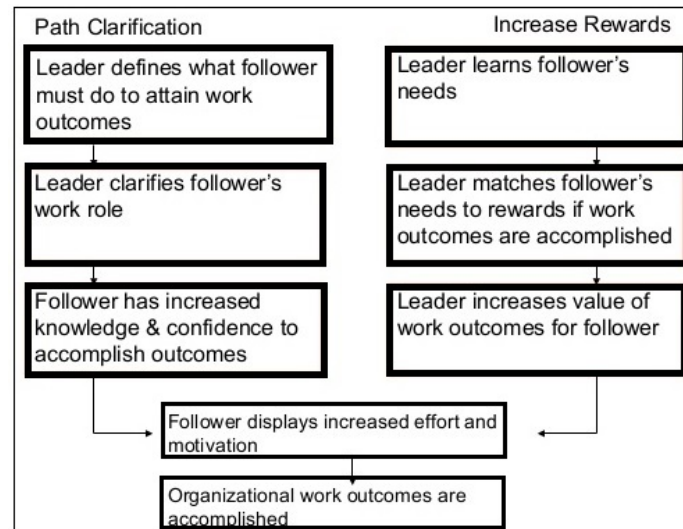

Figure 4: Leader Roles in the Path–Goal Model

Source: self-created in reference to Daft, R.L., (2018), *The Leadership Experience, 7th Edition, Cengage Learning*.

A leader may perform these behaviors by adopting a certain leadership style based on the situation. The path–goal theory suggests a fourfold classification of leadership styles (House, 1971):

- *Supportive Leadership*: leader is friendly and approachable, attends to the wellbeing of subordinates, and treats everyone as equal.
- *Directive Leadership*: leader gives instructions, expectations, timelines, and performance standards.
- *Participative Leadership*: leader invites subordinates to give ideas, share opinions and integrates their suggestions into the decision-making process.
- *Achievement-Oriented Leadership*: leader challenges subordinates to perform at the highest level possible. Leader has high standards of excellence and seeks continuous improvement.

Some examples of how leadership behavior is tailored to the situation can be seen in Figure 5.



Figure 5: Path–Goal Situations and Preferred Leader Behaviors

Source: self-created in reference to Daft, R.L., (2018), *The Leadership Experience, 7th Edition, Cengage Learning*.

In all four cases, the outcome of fitting the leadership behavior to the situation produces greater employee effort by either clarifying how subordinates can receive rewards or changing the rewards to fit their needs (Daft, 2018).

3.3.4. Vroom, Yetton and Jago's Contingency Model

This model was first developed by Vroom and Yetton (1973) and some contributions were subsequently made by Vroom and Jago (1988). In the model, it is assumed that different leadership styles can be displayed by the same leader. The Vroom-Yetton-Jago Model asserts that, during the decision-making process, the contribution of the followers is important. The aim of the model is, while maintaining the quality of the decision, to provide the acceptance of it by the followers (Vroom & Jago, 1988; Vroom & Yetton, 1973). This leadership contingency model relates leadership behavior and participation in decision-making.

The model starts with the idea that a leader faces a problem that requires a solution. As a decision-making model, its premise is that the most effective leadership decision style depends on whether the leader desires a high-quality decision or is more concerned with subordinates' acceptance of the decision (Vroom & Yetton, 1973). The model's purpose is to predict when leaders should or should not allow subordinates to participate in the decision-making process. Vroom and Yetton (1973) determined five leadership styles from autocratic leadership to democratic leadership (Figure 6). A leader can choose to be autocratic and make decisions without input from employees or display democratic behaviors and encourage participation and input.

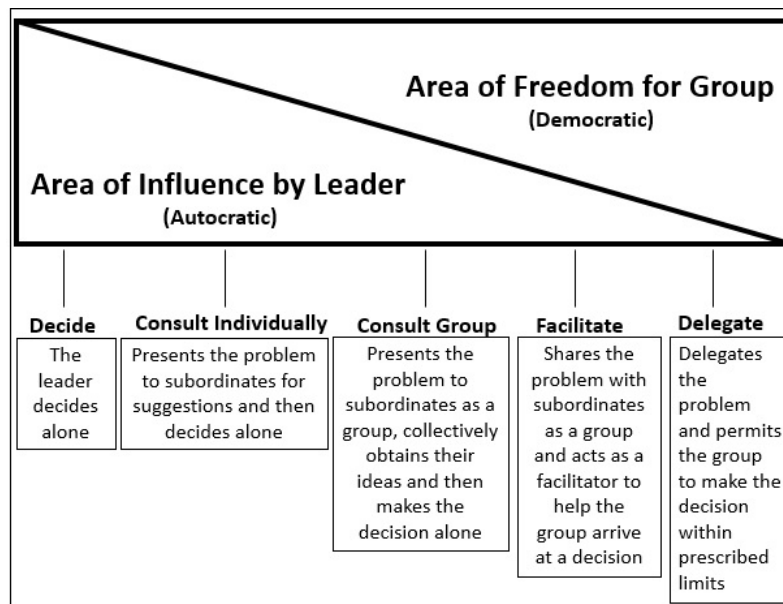

Figure 6: Vroom-Yetton-Jago Model Five Leader Decision Styles

Source: self-created in reference to Vroom, V.H. (2000), *Leadership and the decision making process. Organizational Dynamics*, 28(4), 82–94.

Vroom and Yetton's (1973) model is a normative model and it suggests a sequence of rules to be followed for determining the decision-making style. Seven diagnostic questions in the following areas can determine how much subordinates should participate in making a decision:

- *Decision Significance.* How significant is this decision for the project or organization?
- *Importance of Commitment.* How important is subordinate commitment to carrying out the decision?
- *Leader Expertise.* What is the level of the leader's expertise in relation to the problem?
- *Likelihood of Commitment.* If the leader were to make the decision alone, would subordinates have high or low commitment to the decision?
- *Goal Alignment.* Are the employee goals aligned with organizational goals?
- *Group Expertise.* What is the level of group members' knowledge and expertise in relation to the problem?
- *Team Competence.* How skilled and committed are group members to working together as a team to solve problems?

As the leader answers each question as high (H) or low (L), the answer will take the leader through the decision tree to an appropriate outcome (Figure 7).

		→								
		Decision Significance	Importance of Commitment	Leader Expertise	Likelihood of Commitment	Goal Alignment	Group Expertise	Team Competence		
P R O B L E M S T A T E M E N T	H	H	H	H	-	-	-	Decide		
				L	H	H	H	H	Facilitate	
						L	-	-	Consult (Group)	
			L	H	H	H	H	H	Delegate	
					L	-	-	Consult (Individually)		
					L	-	-	Facilitate		
		L	H	L	H	H	H	H	Facilitate	
					L	-	-	Consult (Group)		
					L	-	-	Decide		
			L	L	-	H	H	H	H	Facilitate
						L	-	-	Consult (Individually)	
						L	-	-	Decide	
	L	H	-	H	-	-	-	Decide		
				L	-	-	H	Delegate		
		L	-	-	-	-	-	-	Facilitate	
					-	-	-	-	Decide	

Figure 7: Vroom-Yetton-Jago Model Leadership Decision Tree

Source: Vroom, V. H. (2000). *Leadership and the decision making process. Organizational Dynamics*, 28(4), 82–94.

The main assumption of the Vroom-Yetton-Jago Model is that there is no single leadership style or decision-making process that fits all situations. To find the process best suited to the situation, the leader needs to consider a number of factors. The model walks the leader through these factors logically, to help to identify the most appropriate process and style. Leaders can quickly learn to use the model to adapt their styles to fit the situation.

3.4. Contemporary Leadership Theories

Around the 1980s, the face of the business world and, in turn, the concept of effective leadership changed. Conger and Kanungo (1994) stated that: “earlier distinctions between task-oriented and people-oriented and some contingency approaches such as Fiedler’s Contingency and Path Goal Theories seemed inadequate to address certain organizational leadership issues of the 1980s.” Due to rapid globalization in the world, it became a lot harder to lead large-scale companies and be successful in change efforts. This new environment demanded different characteristics and skills from so-called effective leaders. This need in the business world emerged ‘contemporary leadership theories’ around the 1980s. Researchers defined new leadership styles and models which would not have been replaced nor explained by any other models, such as the people-oriented and task-oriented leadership models (Bass, 1990). These new leadership styles are Charismatic Leadership, Transformational Leadership, Transactional Leadership and Servant Leadership.

3.4.1. Charismatic Leadership

The charismatic leadership approach today could be considered as the most influential approach on leadership studies (Winkler, 2010). Today's theories of charismatic leadership are strongly influenced by the ideas of an early sociologist, Max Weber. He used the term to define a form of influence-based not on traditional or formal authority, but rather on follower perceptions that the leader is endowed with exceptional powers or qualities (Weber, 1947). According to Weber, charisma takes place during a social crisis, when a leader emerges with a radical vision that proffers a solution to the crisis and attracts followers who believe in the vision (Yukl, 2010). Modern development of charismatic leadership theory is often attributed to the work of Robert House (Luthans, 2010). According to House's charismatic leadership theory, followers attribute heroic or extraordinary leadership abilities when they observe certain behaviors (Conger & Kanungo, 1988; Robbins & Judge, 2013).

Several studies have tried to identify the characteristics of charismatic leaders: they have a vision, they are willing to take personal risks to achieve that vision, they are sensitive to follower needs, and they present marvelous behaviors (Conger & Kanungo, 1998; Robbins & Judge, 2013). Most experts believe that individuals are not only born with traits that make them charismatic, but also they can be trained to present charismatic behaviors (Robbins & Judge, 2013). Evidence suggests that charismatic leaders influence their followers in a four-step process. It begins with articulating an appealing vision, a long-term strategy for attaining a goal by linking the present with a better future for the organization. Second, charismatic leaders may use vision statements to imprint on followers an overarching goal and purpose. They build followers' self-esteem and confidence with high performance expectations and belief that followers can attain them. Third, through words and actions, the leader transmits a new set of values and sets an example for followers to imitate. Finally, the charismatic leader engages in emotion-inducing and often unconventional behavior to demonstrate courage and conviction about the vision. Followers catch the emotions their leader is conveying (Robbins & Judge, 2013; Shamir, House, & Arthur, 1993).

Charisma can be used for positive outcomes that benefit the group, and charismatic leaders can be portrayed as wonderful heroes. However, there can also be unethical characteristics associated with charismatic leaders. It can also be used for self-serving purposes that lead to deception, manipulation and exploitation of others (Daft & Marcic, 2009; Luthans, 2010).

3.4.2. Transformational Leadership

Transformational leadership represents a paradigm shift with regard to the study of leadership (Medley & Larochelle, 1995). As an emerging leadership paradigm, transformational leadership focuses on transformation of the organization and its members from the current state to a better state that is aligned with organizational vision, mission and goals (Top, Akdere, & Tarcan, 2015). The term transformational leadership was first introduced by Burns (1978). According to him, transformational leaders provide change and movement in an organization. They emphasize new possibilities and promote a compelling vision of the future to minimize resistance to change. Transformational leaders manifest passionate inspiration, and visibly model appropriate behaviors (Burns, 1978). Transformational leaders are briefly referred to as change agents (Eisenbach, Watson, & Pillai, 1999).

Following Burns' theory of leadership, Bass (1985) described a more detailed theory for transformational leadership. According to Bass (1985), transformational leaders make the followers more aware of the importance and values of task outcomes, activate their higher order needs, and stimulate followers to act for the sake of the organization. Bass (1985) noted that transformational leaders broaden and elevate the interests of their constituencies, and that they do so by generating awareness and acceptance of the purposes and mission of the group. Bass (1985) defined transformational leaders by their charismatic appeal to their followers, the inspiration they provide them and the individual consideration they give them. Transformational leadership also involves motivating the followers to perform beyond the minimum level of requirements for the organization by putting higher level goals and developing an appropriate work environment (Rafferty & Griffin, 2004; Williams et al., 1999). In the light of findings throughout the years, some characteristics of transformational leaders can be summarized as in Table 5.

Table 5: Characteristics of Transformational Leaders

Researchers	Characteristics of Transformational Leaders
Burns, (1978)	<ul style="list-style-type: none"> • They provide change and movement in an organization.
Bass, (1985)	<ul style="list-style-type: none"> • They broaden and elevate the interests of their constituencies.
Kuhnert and Lewis, (1987)	<ul style="list-style-type: none"> • They are capable of having profound and extraordinary effects on people by causing shifts in the beliefs, the needs, and the values of followers; thus followers can become leaders themselves.
Den Hartog et al., (1997)	<ul style="list-style-type: none"> • They transform the organization by defining the need for change, creating new visions, mobilizing commitment to these visions and by providing awareness of the organizational vision and goals.
Eisenbach et al., (1999)	<ul style="list-style-type: none"> • They are referred to as change agents.
Egri and Herman, (2000)	<ul style="list-style-type: none"> • They tend to direct specific activities as much as to alter moods, to evoke symbolic images and expectations, and to inspire desires and objectives.
Antonakis et al., (2003)	<ul style="list-style-type: none"> • They are proactive, raise follower awareness for transcendent collective interests and motivate followers to achieve out of range goals.
Avolio and Bass, (2004)	<ul style="list-style-type: none"> • They inspire followers to go beyond their own self-interests for the good of the organization with their vision. • They heighten the awareness of followers with vision they create and the strategies for reaching them. • They develop higher level needs for followers such as achievement, autonomy, and affiliation, which can be both work and not work related.

Source: Self-created

Transformational leaders consider their employees' individual differences and mentor them to develop themselves. Such leaders stimulate their incumbents intellectually, encourage and show them how to solve old problems with a new style, and put emphasis on rationality as a problem solving strategy (Bass, 1990).

The first clear distinction between transformational and transactional leadership was made by Burns (1978) in describing the leadership process as '*transformational*'. Bass refined the concept of transformational leadership and transactional leadership through numerous research studies in business organizations (Bass, 1999; Bass, Avolio, Jung, & Berson, 2003, Bass, Berson, & Riggio, 2006; Yammarino, Spangler, & Bass, 1993). The vast majority of researchers in existing leadership literature suggest that transformational leadership is one of the most influential approaches towards leadership (Avolio & Bass, 1995; Bass, 1995; Bass et al., 2003; Bass & Avolio, 1994; Bass et al., 2006; Bass & Steidlmeier, 1999; Hater, Bass, & Guion, 1988; Kouzes & Posner, 2007).

3.4.3. Transactional Leadership

Transactional leadership generally uses organizational bureaucracy, policy, power, and authority to maintain control; this style of leadership is occasionally referred to as authoritative (Bennet, 2009). Transactional leaders emphasize work standards, assignments, and task-oriented goals. In addition, transactional leaders tend to focus on task completion and employee compliance, and these leaders rely quite heavily on organizational rewards and punishments to influence employee performance (Tracey & Hinkin, 1998). They explain what is required of them and what compensation they will receive if they fulfil these requirements (Bass, 1990).

Transactional leadership focuses on ways to maintain the status quo and manage the day-to-day operations of a business. It does not focus on identifying the organization's goals and how employees can work toward and increase their productivity in alignment with these goals, thus increasing organizational profitability (Avolio, Waldman, & Yammarino, 1991).

Followers are motivated and corrected by the leaders' transactional actions. Egri and Herman (2000) defined the main concern of transactional leaders as being that of the accomplishment of the subordinates' task performance in terms of meeting organizational goals and objectives. Leaders gain the commitment of employees through giving them contingent rewards. Therefore, Kuhnert and Lewis (1987) suggested that effective transactional leaders must regularly fulfil the expectations of their followers.

The basis of transactional leadership is a transaction or exchange process between leaders and followers. The transactional leader recognizes followers' needs and desires and then clarifies how those needs and desires will be satisfied in exchange for meeting specified objectives or performing certain duties. Thus, followers receive rewards for job performance, while leaders benefit from the completion of tasks (Vecchio, 2002). Because of these transactional relationships, some of the theories explained in the previous section can be considered as transactional theories, such as path-goal theory and initiating structure. Transactional leadership involves a commitment to '*follow the rules*'; therefore, transactional leaders maintain stability within the organization rather than promoting change (Vecchio, 2002).

There is a temporary process for transactional leadership. Once a transaction is complete, the relationship between the leader and subordinates can end or be redefined for the next transaction (Lussier & Achua, 2001). Therefore, the nature of this kind of leadership style is based on a short-term relationship between leader and follower.

Comparison between Transformational and Transactional Leadership

Burns (1978) stated that transactional leaders motivate followers to perform their jobs, while transformational leaders insist on satisfying the needs of their followers. Burns (1978) also suggested that transactional and transformational leaderships are the two opposite ends of a whole.

An important point that separates a transactional leader from a transformational leader is that a transactional leader focuses on economy. That means a transactional leader is sensitive to who will better perform which job (Rosenberg, 1996). On the other hand, transformational leadership is the ability of understanding followers' needs, desires and what motivates them and also it is the ability of satisfying followers; thus, benefiting from employees' full capacity (Bennis, 1984; Conger, 1989; Conger & Kanungo, 1987; Sashkin & Sashkin, 1990).

Judge and Piccolo's (2004) study, which is about the relationship between transformational and transactional leadership, states that it is difficult to reveal the effect of each one of the leadership style because of the high relationship between these leadership styles. In transactional leadership, leaders and followers enter the interaction to be able to satisfy their needs mutually. However, in transformational leadership, leaders and followers enter the interaction to have a more creative environment for the benefit of the entire organization (Judge & Piccolo, 2004).

According to Ross and Offerman (1997), transformational leaders try to change organizational culture, followers' norms, targets and ideals. They try to exceed the expectations of their followers. However, transactional leaders try to reach current targets.

Bass (1995) claimed that both leadership styles can be observed in a leader. In fact, he claimed that, if transformational leadership is based on transactional leadership, the effect of the latter will be higher. Parallel to this view, Bass and Steidlmeier (1999) also affirmed that transactional and transformational leaderships are interrelated and the best of leadership emerges when they are used together. Avolio and Bass (2002) empirically proved that a combination of both may be effective and may produce positive impacts on performance. On the other hand, many research results show that transformational leadership is more effective than transactional leadership (Conger & Kanungo, 1987; Kirkpatrick & Locke, 1991; Oзарalli, 2003)

3.4.4. Servant Leadership

In the second half of the 20th century, traditional, autocratic and hierarchical leadership models were beginning to yield to newer ones (Bass, 1985; Spears, 1995). Robert K. Greenleaf (1970) defined his concept of servant

leadership, which stressed the need for a new, more holistic community-based leadership model. Ethical and caring behavior is key in this type of leadership.

Greenleaf (1970) also defined the servant leadership as leadership behavior motivated by the intention to serve so that the followers become empowered, responsible, healthier, wiser, and autonomous. Graham (1991) proposed that servant leadership would emerge as humility, relational power, autonomy and moral development of followers and emulation of leaders' service orientation. Sendjaya and Sarros (2002) studied the historical evolution of servant leadership and portrayed it as a genuine sense of calling to be just and trusted stewards and to inspire in others the full potential of their abilities.

According to Greenleaf (1970), the word 'servant' implies an approach to leadership that supports the moral and ethical empowerment of others, which is an important ingredient of becoming a servant leader. The implication of Greenleaf's conceptualization of servant leadership is that "leadership without service is less substantial, more ego-driven and selfish, instead of being community centered, altruistic and empathetic" (Crippen, 2005, p.4). Servant leadership is, therefore, not a model of leadership that is self-serving, manipulative, short-sighted or power oriented, but is motivated by the underlying principles of service (Taylor, 1998). Servant leaders believe that it is their duty to see to the overall mental and spiritual wellbeing of those with whom they associate. When people receive service and guidance from others, they will, in return, serve and lead more people, to the extent that a wider number of employees, consumers, and even the whole society perceive this service (Taylor, 1998).

The notion of servant leadership has received growing attention and recognition in recent years (Sendjaya & Sarros, 2002). Various researchers have espoused servant leadership as a valid theory of organizational leadership (Russell & Stone, 2002) with great promise for theoretical and practical development.

4. Conclusion

The productivity and success of the organizations depend on the understanding of the complex and multifaceted human factor and the creation of an appropriate working environment. It is very important to create employee productivity and job satisfaction by applying effective leadership styles, as well as to achieve organizational goals and effectiveness. At this point, the knowledge of leadership theories may help to interact better with employees and to activate more effective leadership processes.

The paper has provided a comprehensive review on the literature, research and theoretical framework of leadership. The leadership approaches mentioned in this paper need to be fully understood in order to achieve individual and organizational effectiveness and efficiency. It is hoped that this work will serve as a resource for leadership researchers.

References

- Alonderiene, R., & Majauskaite, M. (2016). Leadership Style and Job Satisfaction in Higher Education Institutions. *International Journal of Educational Management*, 30(1), 140-164. <https://doi.org/10.1108/IJEM-08-2014-0106>
- Antonakis, J., Avolio, B.J., & Sivasubramaniam, N. (2003). Context and Leadership: An Examination of the Nine-Factor Full-Range Leadership Theory Using the Multifactor Leadership Questionnaire. *The Leadership Quarterly*, 14(3), 261-295. [https://doi.org/10.1016/S1048-9843\(03\)00030-4](https://doi.org/10.1016/S1048-9843(03)00030-4)
- Avolio, B.J., & Bass, B.M. (1995). Individual Consideration Viewed at Multiple Levels of Analysis: A Multi-Level Framework for Examining the Diffusion of Transformational Leadership. *The Leadership Quarterly*, 6(2), 199-218. [https://doi.org/10.1016/1048-9843\(95\)90035-7](https://doi.org/10.1016/1048-9843(95)90035-7)
- Avolio B.J., & Bass B.M. (2002). *Developing Potential Across a Full Range of Leadership, Cases on Transactional and Transformational Leadership*. Mahwah, NJ: Lawrence Erlbaum Associates. <https://doi.org/10.4324/9781410603975>
- Avolio, B.J., & Bass, B.M. (2004). *Multifactor Leadership Questionnaire, Manual and Sampler Set (3rd ed.)*. Mind Garden, Inc.

- Avolio, B.J., Waldman, D.A., & Yammarino, F.J. (1991). Leading in the 1990s: The Four I's of Transformational Leadership. *Journal of European Industrial Training*, 15(4). <https://doi.org/10.1108/03090599110143366>
- Bass B.M. (1961). Some Aspects of Attempted, Successful and Effective Leadership. *Journal of Applied Psychology*, 45, 120-122. <https://doi.org/10.1037/h0049166>
- Bass, B.M. (1985). *Performance beyond Expectations*. New York: Free Press.
- Bass, B.M. (1990). *Handbook of Leadership: A Survey of Theory and Research*. New York: Free Press.
- Bass, B.M. (1994). *Improving Organizational Effectiveness through Transformational Leadership*. Thousand Oaks: Sage.
- Bass, B.M. (1995). Theory of Transformational Leadership Redux. *The Leadership Quarterly*, 6(4), 463-478. [https://doi.org/10.1016/1048-9843\(95\)90021-7](https://doi.org/10.1016/1048-9843(95)90021-7)
- Bass, B.M. (1997). Does the Transactional-Transformational Leadership Paradigm Transcend Organizational and National Boundaries? *American Psychologist*, 52(2), 130-139. <https://doi.org/10.1037/0003-066X.52.2.130>
- Bass, B.M. (1999). Two Decades of Research and Development in Transformational Leadership. *European Journal of Work and Organizational Psychology*, 8(1), 9-32. <https://doi.org/10.1080/135943299398410>
- Bass, B.M., & Avolio, B.J. (1994). Transformational Leadership and Organizational Culture. *International Journal of Public Administration*, 17(3-4), 541-554. <https://doi.org/10.1080/01900699408524907>
- Bass, B.M, Avolio, B.J, Jung, D.I., & Berson, Y. (2003). Predicting Unit Performance by Assessing Transformational and Transactional Leadership. *Journal of Applied Psychology*, 88(2), 207-218. <https://doi.org/10.1037/0021-9010.88.2.207>
- Bass, B.M, Berson, Y., & Riggio, R.E. (2006). *Transformational Leadership* (2nd e.). Mahwah, NJ: Lawrence Erlbaum Associates Publishers. <https://doi.org/10.4324/9781410617095>
- Bass, B.M., & Steidlmeier, P. (1999). Ethics, Character, and Authentic Transformational Leadership Behavior. *The Leadership Quarterly*, 10(2), 181-217. [https://doi.org/10.1016/S1048-9843\(99\)00016-8](https://doi.org/10.1016/S1048-9843(99)00016-8)
- Bennett, T.M. (2009). A Study of The Management Leadership Style Preferred by IT Subordinates. *Journal of Organizational Culture, Communications and Conflict*, 13(2), 1-26.
- Bennis, W.G. (1959). Leadership Theory and Administrative Behavior: The Problems of Authority. *Administrative Science Quarterly*, 4, 259-301. <https://doi.org/10.2307/2390911>
- Bennis, W.G. (1984). The Four Competencies of Leadership. *Training and Development Journal*, 38(8), 14-19.
- Bernard L.L. (1927). Leadership and Propaganda. In J. Davis & H.E. Barnes (Eds.), *An Introduction to Sociology*. New York: Heath.
- Blackmar, F.W. (1911). Leadership in Reform. *American Journal of Sociology*, 16, 626-644. <https://doi.org/10.1086/211917>
- Blake, R.R., & McCause, A.A. (1991). *Leadership Dilemmas-Grid Solutions*. Gulf Professional Publishing.
- Blake, R.R., & Mouton, J.S. (1985). *The Managerial Grid III: A New Look at The Classic that has Boosted Productivity and Profits for Thousands of Corporations Worldwide*. Houston: Gulf Publishing Company, Book Division.
- Blanchard, K., Spears, L.C., & Lawrence, M., (2001). *Focus on Leadership: Servant Leadership for the 21st Century* (3rd ed.). New York: John Wiley.
- Bolden, R., Gosling, J., Marturano, A., & Dennison, P. (2003). *A Review of Leadership Theory and Competency Frameworks*. Center for Leadership Studies University of Exeter. United Kingdom
- Burns, J.M. (1978). *Leadership*. New York: Harper & Row.
- Conger, J. A., & Kanungo, R. N. (1987). Toward a Behavioral Theory of Charismatic Leadership in Organizational Settings. *Academy of Management Review*, 12(4), 637-647. <https://doi.org/10.5465/amr.1987.4306715>
- Conger, J.A., & Kanungo, R.N. (1988). Behavioral Dimensions of Charismatic Leadership. in J.A. Conger, R.N. Kanungo & Associates (Eds.), *Charismatic Leadership* (p. 79). San Francisco: Jossey-Bass.
- Conger, J.A., & Kanungo, R.N. (1994). Charismatic Leadership in Organizations: Perceived Behavioral Attributes and Their Measurement. *Journal of Organizational Behavior*, 15(5), 439-452. <https://doi.org/10.1002/job.4030150508>
- Conger, J.A., & Kanungo, R.N. (1998). *Charismatic Leadership in Organizations*. Thousand Oaks, CA: Sage.
- Conger, J.A. (1989). Leadership: The Act of Empowering Others. *Academy of Management Executive*, 3(1), 17-25. <https://doi.org/10.5465/ame.1989.4277145>
- Copeland, N. (1942). *Psychology and the Soldier*. Harrisburg: Military Service Publication.
- Crippen, C. (2005). The Democratic School: First to serve, then to lead. *Canadian Journal of Educational Administration and Policy*, (47).
- Daft, R.L., & Marcic, D. (2009). *Understanding Management* (6th ed.). Mason, USA: South Western Cengage Learning.
- Daft, R.L. (2018). *The Leadership Experience* (7th ed.). Cengage Learning.
- Den Hartog, D.N., Van Muijen, J.J., & Koopman, P.L. (1997). Transactional versus Transformational Leadership: An Analysis of the MLQ. *Journal of Occupational and Organizational Psychology*, 70(1), 19-34. <https://doi.org/10.1111/j.2044-8325.1997.tb00628.x>

- Den Hartog, D.N., & Koopman, P.L. (2001). Leadership in Organizations. *Handbook of Industrial, Work & Organizational Psychology*, 2, 166-187. <https://doi.org/10.4135/9781848608368.n10>
- Drucker P. F. (1998). *The Leader of the Future*. San Francisco: Jossey Bass.
- Egri, C.P., & Herman, S. (2000). Leadership in the North American Environmental Sector: Values, Leadership Styles, and Contexts of Environmental Leaders and Their Organizations. *Academy of Management Journal*, 43(4), 571-604. <https://doi.org/10.5465/1556356>
- Eisenbach, R., Watson, K., & Pillai, R. (1999). Transformational Leadership in the Context of Organizational Change. *Journal of Organizational Change Management*, 12(2). <https://doi.org/10.1108/09534819910263631>
- Feldman, D.C. & Arnold, H.J. (1983). *Managing Individual and Group Behavior in Organizations*. New York: McGraw Hill.
- Fiedler, F. E. (1967). *A Theory of Leadership Effectiveness*. New York: McGraw-Hill.
- Gordon, J.R. (1996). *Organizational Behavior A Diagnostic Approach*. Upper Saddle River, NJ: Prentice Hall.
- Graham, J.W. (1991). Servant-Leadership in Organizations. *Inspirational and Moral Leadership Quarterly*, 2(2), 105-119. [https://doi.org/10.1016/1048-9843\(91\)90025-W](https://doi.org/10.1016/1048-9843(91)90025-W)
- Greenleaf, R.K. (1970). *The Servant as a Leader*. Indianapolis: Greenleaf Center.
- Hampton, D.R., Summer, C.E. & Webber, R.A. (1978). *Organizational Behavior and the Practice of Management* (3rd ed.). Glenview, IL: Scott, Foreman and Company.
- Hater, J.J., Bass, B.M., & Guion, R. (1988). Superiors' Evaluations and Subordinates' Perceptions of Transformational and Transactional Leadership. *Journal of Applied Psychology*, 73(4), 695-702. <https://doi.org/10.1037/0021-9010.73.4.695>
- Heller, F.A., & Yukl, G. (1969). Participation, Managerial Decision-Making, and Situational Variables. *Organizational Behavior and Human Performance*, 4(3), 227-241. [https://doi.org/10.1016/0030-5073\(69\)90007-5](https://doi.org/10.1016/0030-5073(69)90007-5)
- Hemphill, J.K., & Coons, A.E. (1957). Development of the Leader Behavior Description Questionnaire. In R. Stogdill & A. Coons (Eds.). *Leader Behavior: Its Description and Measurement* (pp.6-38). Columbus, Ohio: Bureau of Business Research.
- Hersey, P., & Blanchard, K.H. (1969). Life Cycle Theory of Leadership. *Training & Development Journal*, 23(5), 26-34.
- Hersey, P., & Blanchard, K.H. (1993). *Management of Organizational Behavior – Utilizing Human Resources* (6th ed.). New Jersey: Prentice-Hall International.
- House, R.J. (1971). A Path-Goal Theory of Leader Effectiveness. *Administrative Science Quarterly*, 16(3), 321-339. <https://doi.org/10.2307/2391905>
- Ilies, R., Nahrgang, J.D., & Morgeson F.P. (2007). Leader-Member Exchange and Citizenship Behaviors: A Meta-Analysis. *Journal of Applied Psychology*, 92 (1), 269 –277. <https://doi.org/10.1037/0021-9010.92.1.269>
- Judge, T.A., & Piccolo, R.F. (2004). Transformational and Transactional Leadership: A Meta-Analytic Test of Their Relative Validity. *Journal of Applied Psychology*, 89(5), 755. <https://doi.org/10.1037/0021-9010.89.5.755>
- Jung, R.H. (2013). *Allgemeine Managementlehre* (6th ed.). Berlin: ESV.
- Katz, D., Kahn, R. (1966). *The Social Psychology of Organizations*. New York: Wiley.
- Kirkpatrick, S.A., & Locke, E.A. (1991). Leadership: Do Traits Matter? *Academy of Management Executive*, 5(2), 48-60. <https://doi.org/10.5465/ame.1991.4274679>
- Knickerbocker, I. (1948). Leadership: A Conception and Some Implications. *Journal of Social Issues*, 4, 23-40. <https://doi.org/10.1111/j.1540-4560.1948.tb01508.x>
- Kouzes, J.M., & Posner, B. (2007). *The Leadership Challenge* (4th ed.). San Francisco: Jossey- Bass.
- Kuhnert, K.W., & Lewis, P. (1987). Transactional and Transformational Leadership: A Constructive/Developmental Analysis. *Academy of Management Review*, 12(4), 648-657. <https://doi.org/10.5465/amr.1987.4306717>
- LePine, J.A, Erez, A., & Johnson, D.E. (2002). The Nature and Dimensionality of Organizational Citizenship Behavior: A Critical Review and Meta-Analysis. *Journal of Applied Psychology*, 87(1), 52-65. <https://doi.org/10.1037/0021-9010.87.1.52>
- Lewin, K. (1939). Field Theory and Experiment in Social Psychology: Concepts and Methods. *American Journal of Sociology*, 44(6), 868-896. <https://doi.org/10.1086/218177>
- Lord, R.G., De Vader, C.L., & Alliger, G.M. (1986). A Meta-Analysis of the Relation between Personality Traits and Leadership Perceptions: An Application of Validity Generalization Procedures. *Journal of Applied Psychology*, 71(3), 402-410. <https://doi.org/10.1037/0021-9010.71.3.402>
- Lussier, R.N., & Achua, C.F. (2001). *Leadership: Theory, Application, Skill Building*. Cincinnati: South Western College.
- Luthans, F. (2010). *Organizational Behavior an Evidence Based Approach* (12th ed.). McGraw-Hill/Irwin.
- Mann, R.D. (1959). A Review of the Relationships between Personality and Performance in Small Groups.

- Psychological Bulletin, 56(4), 241-270. <https://doi.org/10.1037/h0044587>
- Medley, F., & Larochelle, D.R. (1995). Transformational Leadership and Job Satisfaction. *Nursing Management*, 26(9), 64JJ-64NN. <https://doi.org/10.1097/00006247-199509000-00017>
- Northouse, P.G. (2004). *Leadership: Theory and Practice*. Thousand Oaks: Sage.
- Ozaralli, N. (2003). Effects of Transformational Leadership on Empowerment and Team Effectiveness. *Leadership & Organization Development Journal*, 24(6), 335-344. <https://doi.org/10.1108/01437730310494301>
- Podsakoff, P.M., MacKenzie, S.B., Moorman, R.H., & Fetter, R. (1990). Transformational Leader Behaviors and Their Effects on Followers' Trust in Leader, Satisfaction and Organizational Citizenship Behaviors. *Leadership Quarterly*, 1(2), 107-142. [https://doi.org/10.1016/1048-9843\(90\)90009-7](https://doi.org/10.1016/1048-9843(90)90009-7)
- Pondy, L.R. (1989). Leadership as a Language Game, In M.W. McCall Jr & M.M. Lombardo (Eds.), *Leadership*. Durham: Duke University Press.
- Rafferty, A.E., & Griffin, M.A. (2004). Dimensions of Transformational Leadership: Conceptual and Empirical Extensions. *The Leadership Quarterly*, 15(3), 329-354. <https://doi.org/10.1016/j.leaqua.2004.02.009>
- Robbins, S.P., & Judge, T.A. (2013). *Organizational Behavior* (15th ed.). New Jersey: Prentice Hall.
- Robbins, S.P., & Coulter, M., (2005). *Management* (8th ed.). New Jersey: Pearson Prentice Hall.
- Rosenberg, P. (1996). Comparative Leadership Styles of Male and Female Therapists. In B. DeChant (Ed.), *Women and Group Psychotherapy*, New York, NY; Guilford Press.
- Ross, M.S., & Offerman, R.L. (1997). Transformational Leaders: Measurement of Personality Attributes and Work Performance. *Personality & Social Psychology Bulletin*, 23 (10), 1078-1086. <https://doi.org/10.1177/01461672972310008>
- Russell, R.F., & Stone, A.G. (2002). A Review of Servant Leadership Attributes: Developing a Practical Model. *Leadership & Organization Development Journal*, 23(3), 145-157. <https://doi.org/10.1108/01437730210424>
- Sashkin, S., & Sashkin, M.G. (1990). Leadership and Culture Building in Schools: Quantitative and Qualitative Understanding. Paper Presented at a meeting of the American Educational Research Association, Boston.
- Schein, E.H. (1992). *Organizational Culture and Leadership*. San Francisco: Jossey Bass.
- Sendjaya, S., & Sarros, J.C. (2002). Servant Leadership: Its Origin, Development, and Application in Organizations. *Journal of Leadership and Organizational Studies*, 9(2), 57-65. <https://doi.org/10.1177/107179190200900205>
- Shamir, B., House, R.J., & Arthur, M.B. (1993). The Motivational Effects of Charismatic Leadership: A Self-Concept Theory. *Organization Science*, 4(4), 577-594. <https://doi.org/10.1287/orsc.4.4.577>
- Shaw, J., & Newton, J. (2014). Teacher Retention and Satisfaction with a Servant Leader as Principal. *Education*, 135(1), 101-106.
- Siddique, A., Aslam, H.D., Khan, M., & Fatima, U. (2011). Impact of Academic Leadership on Faculty's Motivation and Organizational Effectiveness in Higher Education System. *International Journal of Academic Research*, 3(3), 730-737.
- Spears, L. (1995). *Reflections on Leadership*. New York: John Wiley & Sons, Inc.
- Stogdill, R.M. (1948). Personal Factors Associated with Leadership: A Survey of the Literature. *Journal of Psychology*, 25, 35-71. <https://doi.org/10.1080/00223980.1948.9917362>
- Stogdill, R.M. (1950). Leadership, Membership and Organization. *Psychological Bulletin*, 47(1), 1-14. <https://doi.org/10.1037/h0053857>
- Stogdill, R.M. (1974). *Handbook of Leadership: A Survey of the Literature*. New York: Free Press.
- Tannenbaum R.J. (1961). *Leadership and Organizations, a Behavioral Science Approach*. New York: McGraw Hill.
- Tannenbaum, R., & Schmidt, W.H. (1973). How to Choose a Leadership Pattern. *Harvard Business Review* (May).
- Taylor-Gillham, D.J. (1998). *Images of Servant Leadership in Education*. Unpublished Dissertation, Northern Arizona University, Flagstaff, AZ.
- Top, M., Akdere, M., & Tarcan, M. (2015). Examining Transformational Leadership, Job Satisfaction, Organizational Commitment and Organizational Trust in Turkish Hospitals: Public Servants versus Private Sector Employees. *The International Journal of Human Resource Management*, 26(9), 1259-1282. <https://doi.org/10.1080/09585192.2014.939987>
- Tracey, J., & Hinkin, T. (1998). Transformational Leadership or Effective Managerial Practices? *Group & Organization Management*, 23(3), 220-236. <https://doi.org/10.1177/1059601198233002>
- Vecchio, R.P. (2002). Leadership and Gender Advantage. *The Leadership Quarterly*, 13(6), 643-671. [https://doi.org/10.1016/S1048-9843\(02\)00156-X](https://doi.org/10.1016/S1048-9843(02)00156-X)
- Vroom, V.H., & Yetton, P.W. (1973). *Leadership and Decision-Making*. Pittsburg: University of Pittsburg Press. <https://doi.org/10.2307/j.ctt6wrc8r>
- Vroom, V.H., & Jago, A.G. (1988). *The New Leadership: Managing Participation in Organizations*. Englewood Cliffs, NJ: Prentice Hall.
- Vroom, V.H., & Jago, A.G. (2007). The Role of the Situation in Leadership, *American Psychologist*, 62(1), 17-

24. <https://doi.org/10.1037/0003-066X.62.1.17>
- Vroom, V.H. (2000). Leadership and the Decision-Making Process. *Organizational Dynamics*, 28(4), 82–94. [https://doi.org/10.1016/S0090-2616\(00\)00003-6](https://doi.org/10.1016/S0090-2616(00)00003-6)
- Weber, M. (1947). *The Theory of Social and Economic Organization*. (A.M. Henderson & T. Parsons, Trans.). New York: Oxford University Press.
- Williams, E.S., Pillai, R., & Schriesheim, C.A. (1999). Fairness Perceptions and Trust as Mediators for Transformational and Transactional Leadership: A Two Sample Study. *Journal of Management*, 25 (6), 897-933. <https://doi.org/10.1177/014920639902500606>
- Winkler, I. (2010). *Contemporary Leadership Theories: Enhancing the Understanding of the Complexity, Subjectivity and Dynamic of Leadership*. Denmark: Physica-Verlag.
- Yammarino, F.J., Spangler, W.D., & Bass, B.M. (1993). Transformational Leadership and Performance: A Longitudinal Investigation. *The Leadership Quarterly*, 4(1), 81-102. [https://doi.org/10.1016/1048-9843\(93\)90005-E](https://doi.org/10.1016/1048-9843(93)90005-E)
- Yang, Y.F. (2014). Studies of Transformational Leadership: Evaluating Two Alternative Models of Trust and Satisfaction. *Psychological Reports*, 114(3), 740-757. <https://doi.org/10.2466/01.04.PR0.114k27w2>
- Yang, Y.F., & Islam, M. (2012). The Influence of Transformational Leadership on Job Satisfaction: The Balanced Scorecard Perspective. *Journal of Accounting & Organizational Change*, 8(3), 386-402. <https://doi.org/10.1108/18325911211258353>
- Yukl, G. (1989). Managerial Leadership: A Review of Theory and Research. *Journal of Management*, 15(2), 251-289. <https://doi.org/10.1177/014920638901500207>
- Yukl, G. (2010). *Leadership in Organizations* (7th ed.). New Jersey: Pearson Education
- Zaccaro, S.J., & Klimoski, R. (2001). *The Nature of Organizational Leadership*. San Francisco: Wiley



Determinants of Board Independence in the Banking Sector of Bangladesh

Md. Rezaul Karim¹, Dr. Ranjan Kumar Mitra, FCMA², Ibrahim Khan³

¹ Assistant Professor in the Department of Accounting & Information Systems, University of Dhaka, Dhaka, Bangladesh. Email: reza.aais@du.ac.bd

² Associate Professor in the Department of Accounting & Information Systems, University of Dhaka, Dhaka, Bangladesh. Email: ranjan.aais@du.ac.bd or ranjandu@yahoo.com

³ MBA Graduate in the Department of Accounting & Information Systems, University of Dhaka, Dhaka, Bangladesh.

Abstract

This paper examines the determinants of board independence in the banking sector of Bangladesh. The study applies a multivariate panel regression analysis for the thirty banks listed with DSE covering the period from 2006 to 2016. We use the proportion of independent directors to total number of directors on the board to measure board independence. Findings of the empirical analysis show that a board is likely to be more independent when independent directors have relevant skill and knowledge as required by prevailing corporate governance regulation. Besides, this paper finds that the boards of larger firms are more independent than those of smaller firms. Moreover, the boards of the levered firms tend to be more independent because debt holders exert intense pressure to implement stringent monitoring mechanisms. Another vital finding of this paper is that board independence is lower for older firms. A plausible reason might be that matured firms devise stricter and more efficient internal control mechanisms that offset the need for independent board. This study also reports findings that are contrary to the traditional belief. For example, we find that longer tenure and prior relationship of independent directors with the firm increases board independence by developing a sense of dedicative attachment of the independent directors with the firm. On the other hand, larger and active boards tend to be an impediment for board independence. Finally, we find no association of board independence with growth opportunity, profitability, and board gender diversity. The findings will have policy implications in designing the role of board independence.

Keywords: Board Independence, Corporate Governance, Banking Sector, Bangladesh

JEL Classification: G3, G34, O5

1. Introduction

The collapse of some highly renowned, globally appreciated, and apparently successful corporate giants (i.e. Enron, WorldCom, Tyco International, Olympus etc.) on the onset of the 21st century has caused a major crack in the investors' faith on the governance of firms. This has in turn led to a rethinking by the regulators of the effectiveness of the existing corporate governance mechanisms. In order to regain investors' confidence, regulators, professional bodies, and government agencies have introduced a broad range of laws and codes with

the goal of strengthening the effectiveness of corporate governance mechanisms in both listed and non-listed firms. In line with such a movement, the incorporation of the concept of Independent Directors (ID) in the board to safeguard the broader interest of the stakeholders works as an important tool to ensure sound corporate governance in firms. Thus, regulators and other stakeholders have, from time to time, expressed their concerns regarding the independence and expertise of the independent directors serving in the board.

Independent directors have become a vital instrument in representing the interests of all stakeholders ranging from the tax authority to the minority shareholders. In fact, it is often said that independent directors are the first line of defense for minority shareholders (Juan Ma and Tarun Khanna, 2013). Moreover, being in a position to act without the undue influence of the management, independent directors provide third-party advice and oversight in ensuring the proper governance of the firms. It has been found that shareholders react favorably to the appointment of outside directors (Rosenstein and Wyatt, 1990). Consistent with this, by studying the stock market reaction to the sudden death of an outside director, Nguyen and Nielsen (2010) found that shareholders react negatively to the loss of outside directors. Although the impact of the presence of independent directors on performance is less clear, Knyazeva, Knyazeva, and Masulis (2013) found that independent directors are positively associated with firm value (market to book ratio) and operating performance (ROA). Again, Duchin, Matsusaka, and Ozbas (2010) observed that if the cost of acquiring information is low, performance increases when outside directors are added to the board (Tobin's Q and ROA). In addition, independent directors work as agents of negotiating conflicts of interests between management and the board due to their independence from both. Besides mitigating conflict, independent directors have other advantages as well. They supposedly have more general knowledge compared with an executive director who has more firm-specific knowledge. Thus, the independent directors very often possess a clear view of the environment external to the business and this enables him to identify and focus on various external issues bearing significance to the firm in the long run. This way, independent directors are capable of standing back from each issue and contemplating them in light of their expertise without bias.

The effectiveness of independent directors is limited by the extent to which they are truly independent. Historically not all independent directors have been truly independent. Hwang and Kim (2009) tested whether NYSE accurately measures independence and found that 87% are NYSE independent, but only 62% are both NYSE and socially independent. Independent directors need true independence from the board and management in order to ensure a harmless tie between the controlling and minority interest, sound governance and promote a culture of transparency as well as accountability. In Times of Malta, Christmas (2014) accurately emphasizes the independence of an independent director from managers and other service providers meaning the independent director and his close relatives must not be the employees or even owners of the service providers. He mentions that the reason of such a drive towards independence is the avoidance of conflicts of interests. Christmas (2014) adds that the reason behind an independent director's ability to add value to the firm is his capability to raise questions and criticize the top management executives should any conflict arises and therefore an independent director is effective only if he has such strength and character that enable him to do so. This implies that independence is the underlying factor that makes independent directors an effective tool to better governance.

All these evidences provide a strong ground to assess the factors affecting the board independence in Bangladesh. In doing so, we choose the banking sector as the area of our study because this is a vastly important sector having massive impact on the economy of Bangladesh. Moreover, the banks in Bangladesh are subject to tight regulatory control because of its involvement with broader public interest. However, this sector is currently facing severe liquidity crisis due to escalating amount of non-performing loan and resulting bad debt. This crisis is often attributed to the lack of good corporate governance practiced by the board. Allegations are that the board itself has overridden internal credit approval process to sanction loan to politically powerful but likely to default loan applicant. The present dismal state of corporate governance in the banking sector underpins the significance of a strong independent board which can serve as a deterrent to the sponsors' family influence on the board. Despite such potential, no extensive research has been conducted to date to investigate board independence in this highly critical sector. The demand for board independence generally originates from regulators, management, shareholders, and creditors of a firm. The limited work concerning board independence in Bangladesh motivates our study and strengthens the empirical significance of the determinants of board independence to different

stakeholders among which the primary are shareholders, managers and regulatory authorities such as Bangladesh Bank or Bangladesh Securities and Exchange Commission.

In this paper, we investigate the determinants of board independence in the banking sector of Bangladesh by using multivariate regression analysis for 30 scheduled banks that provide the required information for the period 2006 to 2016. We exclude specialized banks in this analysis. The main objective of this study is to find out the relevant factors that influence board independence in the banking sector of Bangladesh. The results we report are expected to greatly benefit the shareholders, and regulators. Shareholders can apply the outcome of this paper in deciding what factors to consider before approving the appointment of an independent director in the AGM while regulators can use the findings to assess the effectiveness of existing regulation relating to the improvement of governance through appointing independent directors.

We organize the rest of this paper as follows: section two provides a brief review of prior studies on independent directors which are very inadequate till date. Section three presents the overview of independent directors, their role and relevant attributes. The development of hypotheses and rationale for their development are discussed in section four. Section five deals with various aspects of research design issues. The results of this study are presented, analyzed and discussed in section six and finally, section seven concludes the paper with some suggestions for future research opportunities.

2. Literature Review

There is a huge research gap till date concerning the empirical testing of the determinants of board independence in both local and international arena. The inadequacy of prior works in this field can be attributed to the difficulty of constructing a model that truly captures such a subjective concept as independence. Yet, the same inadequacy inspires me to take this as my topic of study. In this section we provide a succinct summary of prior studies that investigate the independence of the board.

There is a vast literature to improve the corporate governance of firms done by both academics and practitioners. Many such studies have either directly suggested or indirectly inferred that board independence or the existence of independent directors are associated with higher quality of governance while others have mixed findings often suggesting that board independence is neither a necessary nor a sufficient condition for strengthening firm governance practices. Weisbach (1988) found that in case of poor performance, a board dominated by outside independent directors is more likely to fire the top management. Moreover, Brickley, Coles, and Terry (1994) found evidence in favor of their hypothesis that outside directors are more likely to vote in the interests of the shareholders when the firm considers adopting poison pill strategy to avoid unfavorable acquisition. Byrd and Hickman (1992) showed that, a board dominated by outside directors realized much higher abnormal returns during announcement periods of tender offers. Besides, Rosenstein and Wyatt (1990) tested the effect of an event altering a specific governance mechanism. They found that the market reacted quite favorably to the inclusion and addition of outside directors to the board. Again, Gupta and Lee (2004) showed that payments for director premium and officer liability insurance are smaller in firms that have better governance. A general conclusion that follows from the results of these studies is that a board dominated by outside directors mitigate agency costs in various ways. However, two issues need to be mentioned here. First, there is a difference between outside directors and independent directors even though the two terms are often used interchangeably. An independent director is an outside director without any material interests in the business of the firm. This is where the question of determining true independence of independent directors comes. As D Clarke (2006) clearly puts that the concept of non-management directors (NMDs) originate with the objective of assisting stockholders in solving agency problems and if NMDs are to effectively overlook management, they must be independent of the management. Second, contrary findings that no statistically significant relationship exists between the independence of board and firm performance are also in vogue. For example, Bhagat and Black (2001) didn't find any significant relationship between firm performance and independent directors' presence in the board.

Actually, there are two conflicting schools of thoughts regarding the effect of board composition on firm performance-agency theory and stewardship theory (Dalton et.al., 1998; Ramdani and Witteloostuijn, 2010). These

theories provide contradictory predictions about independence of board and firm performance. The approach of agency theory can be used to predict that proportion of independent directors in the board is positively associated with firm performance as a way to mitigate agency costs. On the other hand, stewardship theory hypothetically predicts the same variables to be negatively associated as it assumes that executive directors are more informed about the current and future prospects of the firm than do independent directors and have a greater role to play in the operations of the firm. The findings of various researches regarding the representation of independent directors on the board and firm performance are, therefore, mixed. There are a good number of studies that have empirically examined the relationship between board independence (proportion of IDs in the board of a firm) and firm performance measures such as return on assets (ROA) or return on equity (ROE) and discovered a positive relationship (Hutchinson and Gul, 2002; Bonn, 2004). Knyazeva, Knyazeva, and Masulis (2013) also examined the relation between independent directors and firm performance using a sample of 900 small and mid-sized firms in S&P 1500 index for the period 1996 to 2006. They reported that independent directors positively affect both profitability and operating performance of the firms. On the contrary, others couldn't confirm a robust conclusion about any such statistically significant relationships (Christensen et.al., 2010; Azim, 2012). Some studies have tested the relationship between independence of the board and market-to-book ratios and have been able to display some convincing evidence of a positive and statistically significant relationship (Henry, 2008) while some others have provided a negative and statistically significant relationship (Kiel and Nicholson, 2003). Meanwhile, some researchers cannot confirm that any statistically significant relationship exists between board independence and firm performance (Azim, 2012; Matolcsy et.al., 2004; Bonn, 2004; Pham, Suchard and Zein, 2013; Christensen et.al., 2010). While the balancing evidence suggests that board independence or in other terms, the higher extent of presence of independent directors on the board, improves firm performance, the findings of these studies are obviously mixed.

While it comes about the perceptions of shareholders about independent directors, a large number of studies present findings that favor the independent directors. Examining 1,251 outside directors announcements for the period 1981 to 1985, Rosenstein and Wyatt (1990) found statistically significant positive reaction of stock price in the two-day trading windows around the announcements. They concluded that shareholders had favorable reaction towards the appointment of independent directors and the results were strongest for the small firms. Another study with somewhat similar conclusion put in a different way was undertaken by Nguyen and Nielsen (2010) who examined how the stock market reacts to the sudden death of an independent director. They took into consideration a sample of 229 deaths from 1994 to 2007 and reported that shareholder tend to react negatively to unanticipated loss of an independent director. They also found that the negative reaction was more intense when the directors served key roles such as the chair of the board or head of audit committee or when the representation of independent directors on the board was low and the reaction was comparatively less negative when the directors had already served for longer period in the board. Another striking role played by outside independent directors in enhancing firm value, as reported by Cotter, Shivdasani, and Zenner (1997), is their ability to negotiate higher takeover premiums. That is, independent directors play a role which is both statistically and economically significant in enhancing firm value during tender offers. Moreover, Byrd and Hickman (1992) report empirical findings that support the hypothesis that a more rational merger activity is encouraged by independent directors. However, both Boyd (1994) and Finkelstein and Hambrick (1989) have documented evidence that independent directors don't lead to tighter or lower CEO compensation.

After critically examining the pros and cons of independent directors, an important question to ask is how important it is to determine whether independent directors are truly independent. Realizing the importance of independent directors being free from any managerial influence, D Clarke (2006) nicely puts that directors expected to perform their designated functions cannot actually do so as long as they are not systematically independent of management. As mentioned before, Christian (2018) puts in Times of Malta that it should be definite that an independent director be free not only from managers and executives but also from the service providers, that is he and his close relatives should not have any sort of tie with the employees or even the shareholders of the firm so as to avoid conflict of interests. Recognizing the importance of true independence of independent director, it is worthwhile to have a check on the factors that drive the extent of board independence.

To date, both in local and global arena, there has not been much extensive empirical research about the factors that directly or indirectly determine or even influence the level of board independence. Therefore, the study is motivated to address the research gap regarding the empirical testing of the determinants of board independence in the context of the banking sector of Bangladesh.

3. An Overview of Independent Directors

3.1 Definition of independent director

An independent director is a non-executive member of the board of directors of an incorporated company, who, apart from receiving director's remuneration, does not have any material interest in the company whether pecuniary or not. According to D Clarke (2006), an independent director is *“one who has no need or inclination to stay in the good graces of management, and who will be able to speak out, inside and outside the boardroom, in the face of management's misdeeds in order to protect the interests of shareholders.”*

The definition of independent director is entangled by the term “independent” as it is subject to interpretation rather than any objectively determinable criteria. Still as agreed by most regulators and academics, the term independent here means the absence of any pecuniary or material relationship with the firm in consideration and its insiders such as management and sponsor directors. The concept of independent director thus evolves to deal primarily with the agency problem. As a result, it is expected that independent director should not have any material relationship with firms' insiders whether financial or not that impedes them from undertaking the role they are supposed to play in the board- mitigating agency problems. But the presence of approved *sitting charge* or *fees* doesn't necessarily preclude the independence of independent directors. Thus in India, clause 49 of the listing agreements defined independent directors as *“directors who apart from receiving director's remuneration, do not have any other material pecuniary relationship or transactions with the company, its promoters, its management or its subsidiaries, which in judgment of the board may affect independence of judgment of the directors”*. Similarly emphasizing the importance of independence of independent directors, NYSE states that *“no director qualifies as 'independent' unless the board of directors affirmatively determines that the director has 'no material relationship' with the listed company, either directly or indirectly as a partner, shareholder or officer of an organization that has a relationship with the company.”* In line with the definitions above, regulators in Bangladesh also refer to independent directors as directors who are ‘independent of material monetary and other relationships from management, sponsors, sponsor directors, and controlling shareholders’.

Another important part of the definition of independent directors concerns their expertise. An independent director must possess relevant business acumen so as to enable him to act as a bridge between the management and different stakeholders of the firm ranging from minority shareholders to regulators. In fact, most legislation explicitly mentions that an independent director must be a person of high integrity and sound business knowledge. Moreover, some countries have vested the role of independent directors to a specific class of professionals such as business leaders, law, economics, finance, and accounting professionals and academics of the same areas of expertise, government officials serving higher ranks etc. Closely related with knowledge is the experience of independent directors and it has also been remarked as a distinguishing quality of them. Thus, taken together independent directors must combine integrity, independence, and relevant business knowledge along with experience.

3.2 Independent directors in Bangladesh: A regulatory framework

Although the origin of the concept of independent directors can be traced back to the 1950s even before legislation mandated it, this concept of independent director in Bangladesh is only about a decade old. For the first time, Bangladesh Securities and Exchange Commission (BSEC) introduced the concept of independent director in the country through their corporate governance guideline dated February 20, 2006 (SEC Notification No. SEC/CMRRCD/2006-158/Admin/02-08) which was subsequently amended on August 07, 2012 (SEC NOTIFICATION No. SEC/CMRRCD/2006-158/134/Admin/44). The latter issue of the notification improves the former in several ways. The following table compares the two issues of the CG guidelines regarding provisions related to independent directors.

Table I: Comparative analysis between SEC Notification 2006 and SEC Notification 2012 regarding Independent Directors

Issue	Notification 2006	Notification 2012
Definition of ID	<p>1. It was not clearly mentioned what will be meant by Family relationship and who constituted family relationships.</p> <p>2. Partners or executives of the concerned company's statutory audit firm had not been considered disqualified to be the ID of the company.</p> <p>3. Being a defaulter was not mentioned to be a reason of disqualification for the post of an ID.</p>	<p>1. It has been clearly mentioned that spouse, son, daughter, father, mother, brother, sister, son-in-law, and daughter-in-law shall be considered as family members.</p> <p>2. A current partner or an executive or one who had been the partner or an executive during the preceding 3 (three) years of the concerned company's statutory audit firm is disqualified to be the ID of the company.</p> <p>3. One being convicted by a court of competent jurisdiction as a defaulter in payment of any loan to a bank or a Non-Bank Financial Institution (NBFI) is disqualified for the post of an ID.</p>
Tenure	Nothing was mentioned about the tenure of an ID.	The tenure of office of an independent director shall be for a period of 3 (three) years, which may be extended for 1 (one) term only.
Minimum Number of ID in the Board	At least one tenth (1/10) of the total number of the company's board of directors, subject to a minimum of one shall be independent directors.	At least one fifth (1/5) of the total number of directors in the company's board shall be independent directors.
Appointment of ID	The independent director(s) should be appointed by the elected directors.	The independent director(s) shall be appointed by the board of directors and approved by the shareholders in the Annual General Meeting (AGM).
Vacancy of the post of the ID	Nothing was mentioned about the maximum days for which the post of an ID can remain vacant.	The post of independent director(s) cannot remain vacant for more than 90 (ninety) days.
Maximum number of companies an ID can serve	Nothing was mentioned about the maximum number of companies an ID can serve.	One shall not be an independent director in more than 3 (three) listed companies.
Qualifications of ID	Nothing about the qualifications of IDs was mentioned.	<p>An ID-</p> <ul style="list-style-type: none"> • Shall be a knowledgeable individual with integrity • Is able to ensure compliance with financial, regulatory and corporate laws • Can make meaningful contribution to business • should be a Business Leader/ Corporate Leader/ Bureaucrat/ University Teacher with Economics or Business Studies or Law background/ Professionals like Chartered Accountants, Cost & Management Accountants, Chartered Secretaries • must have at least 12 (twelve) years of corporate

		management/professional experiences
Chairman of the audit committee	May or may not be an ID.	Must be an ID.

By analyzing the two versions of CG guidelines, it has been found that the latest issue of 2012 takes the matter of independent directors as a mechanism of ensuring sound corporate governance quite seriously unlike the past one and has a stronger emphasis on the role and qualifications of independent directors. Yet, it is not all conclusive as it leaves some confusion such as-

- Whether the size of the board is inclusive or exclusive of the IDs while calculating the minimum number of IDs in the board.
- Moreover it has not specified the perquisites and other financial benefits an ID might expect from the company he serves.
- It has not mentioned what is the extent of benefits received by the ID that will not pose a threat to his independence and objectivity.
- The extent to which an ID will be liable if he fails to discharge his responsibilities properly.
- Who are the primary stakeholders (i.e. Shareholders or public interest) the IDs should strive to secure should a conflict of interest occurs etc.

Taken together, it can be said that despite meaningful contribution till date, the introduction of IDs as a solution to corporate governance problems needs to be improved in order to make it viable and BSEC has a significant role to play in this regard.

4. Hypotheses Development

Agency theory implies that information asymmetry would exist in a situation where the ownership of a business is separate from its management. Moral hazard and adverse selection are two major problems that might arise because of such a separation of management from ownership. In such a situation, one would anticipate a conflict of interests between the principals (owners) and agents (management) and the resulting loss is the agency costs. Independent directors can be a useful instrument in mitigating such agency costs by acting as a watchdog in the board with a view to balancing the conflicting interests of the competing groups such as owners and management. But, as one would easily predict, their role will be effective only if they, themselves, are not caught up by any material interests in the business under consideration. Here is where the significance of independent directors' true independence comes into action. Only a truly independent director can add value to the organization as long as it is a matter of displaying a balance of conflicting interests by reducing information asymmetry.

In this section, we develop a set of testable hypotheses for each tentative variable that is likely to have an influence on the independence of the board. We identified some variables from extant literature and suggested some new variables based on our analysis of prior theoretical work on board independence.

4.1 Knowledge and Power

It is usually expected that a positive association exists between the knowledge and skills an individual possesses with his independence in actions. World's leading credit rating organization Moody's in its report titled 'Criteria for Assessing Director Independence' mentions that "We expect that a high level of board independence is matched with sufficiently knowledgeable and engaged directors who can hold management to account."

Fogel, Ma, and Morck (2014) examined whether "powerful" directors behave independently in the board. They defined powerful directors to be those with large professional networks. After examining a sample of 19,223 unique directors from 1998-2010, they found that Powerful directors were associated with more valuable merger-and-acquisition activities and stricter oversight of CEO performance. In addition, powerful directors were associated with less earnings management. They also found that shareholders tend to react negatively to the sudden death of any powerful directors. Taken together, powerful directors exhibit greater independence. On the other

hand, Moody's put forth in 'Criteria for Assessing Director Independence' that sometimes directors with greater sector experience appear to have potential conflicts and this may impair their independence. However, knowledge of industry or expertise and independence are addressed as factors that are not necessarily mutually exclusive (Alex Frino, 2016).

H1: Board independence is positively related to the knowledge and power of independent directors.

4.2 Firm size

It is often argued that larger firms generally adopt stricter monitoring mechanisms, implying more demand on governance tools like audit committee and board independence (Klein 2002). Fama and Jensen (1983) show that larger and more hierarchical firms results from process that are either larger or more complex or both and as a result, larger firms need larger board to provide CEO appropriate advice and necessary access to information as well as resources. This finding suggests that firms with a relatively complex form of operations require a bigger and more independent board. Lehn et al. (2004) also suggest that as the scale and complexity of the firm increase, board independence has to increase as well in order to cater to the greater information needs. Also, it is argued by Anderson et al. (2000) and Coles et al. (2005) that more diversified firms tend to have more IDs in order to carry out the monitoring role expected of them. Considering all these findings, we hypothesize a positive relationship between firm size and board independence.

H2: Board independence is positively related to firm size.

4.3 Financial leverage

A firm with leverage tends to have greater pressure from the creditors to put more transparent governance mechanisms in place so as to safeguard the interest of the creditors and lenders. In Japanese organizations, there is often representation in the board from the creditors while other countries often require greater outside representation (i.e. greater independence) in the board. This is an implication of the debt covenant hypothesis that managers in levered firms with debt covenants tend to manipulate earnings to either delay or even avoid potential violation of debt contracts. For example, Dechow et al. (1996) report that managers have shown tendency to overstate reported earnings in the year before violations of debt covenants. Thus creditors demand greater board independence in a firm with financial leverage. Another view consistent with this hypothesis is that a more complex business is usually a levered one. And as we have mentioned in the previous hypothesis, more complex business requires more independent directors. Thus the third hypothesis becomes:

H3: Board independence is positively related to financial leverage.

4.4 Growth opportunities

Firms that have experienced rapid growth may, at one point, outgrow the infrastructure as well as the internal control system they have. According to Klein (2002) firms that are growing are associated with more uncertainties and greater complexities. He reports that such growing firms generally rely less on independent directors and more on insider directors. Consistent with his findings, Klein (2002) expects lower demand on board independence from both management and shareholders of firms with high growth opportunities. Linck et al. (2008) also show that firms with higher growth opportunities tend to have less independence in the board. This study uses market to book ratio as a proxy for growth. Consequently the hypothesis becomes:

H4: Board independence is negatively related to firm's growth opportunities.

4.5 Profitability

This study recognizes profitability as having an important link with board independence. Adhikary and Mitra (2016) hypothesized that when there is a possibility of private gain for insiders, firms should employ more independent directors in audit committee. From that hypothesis, it is reasonable to conclude that insiders have incentives to manipulate firm profitability to serve self-interests. As a result, greater internal control and stricter

governance mechanism should be put in place to curb such self-interested behavior and obviously this brings back the role of independent directors as a control mechanism. So, our next hypothesis is as follows:

H5: Board independence is positively related to the profitability of a firm.

4.6 Firm age

Linck et al. (2008) demonstrate that when insiders have greater opportunity to derive much of private benefit, firms employ greater number of outside independent directors. Generally older firms develop stricter and more efficient internal mechanisms to bar insiders from extracting such private benefits in comparison to younger firms with low initial investments in developing sophisticated monitoring mechanisms. Thus, we expect older firms to have much less demand for independent directors as a tool to enhance governance and the related hypothesis is:

H6: Board independence is negatively related to firm age.

4.7 Board size

Some authors reported that a reasonably larger board combines varying degree of knowledge and experience of directors and add more value to the firm making a larger board more desirable. In addition, both Collier (1993) and Beasley and Salterio (2001) reported that keeping pace with the increase in board size, the ability of a firm to employ more independent directors increase. Moreover, Adhikary and Mitra (2016) found that firms with larger board had more independent audit committee. On the other hand, it is also argued that monitoring role is stronger in a smaller board and it is less probable that the board be captured by the CEO when it is small. Besides, a general reasoning follows from the field of Origination Behavior (OB) that people tend to be less independent and show more conformity while surrounded by a large number of people having opposite ideas. Following these opposite ideas, we hypothesize that board independence has association with board size without predicting about the direction of association.

H7: Board independence is related to board size.

4.8 Board meetings

Board meeting is a very important part of the overall functioning of many governance mechanisms. In fact, Van den Berghe & Levrau (2003) show that directors themselves put tremendous importance on the quality of board meetings followed only by board composition while judging the elements of good BoD. More frequency in board meetings is a sign that issues of corporate governance are being reviewed more frequently. This also keeps the role of independent directors' a rolling stone that has little chance to gather moss. Thus it might be a positive sign for the governance and work well to the advantage of an ID to demonstrate his independent views regarding different issues. Contrary to the notion imbibed above, more board meetings mean more sitting charge to IDs and the number of board meetings might thus latently be used by the insiders to transfer significant pecuniary benefits to the independent directors even within the legal bounds. Thus the number of board meetings might be used by insiders as a loophole to financially capture the independence of IDs. Considering this view, we hypothesize the following relationship to exist between the number of board meetings and board independence without any specific direction.

H8: Board independence is related to the number of board meetings.

4.9 Board gender diversity

Bohren and Staubo (2015) reported that a 40% mandatory female quota in the board was associated with an increase in board independence. Empirically they found that after such a quota, average fraction of IDs jumped from 67% from 46%. They conveyed that female directors are, indeed, much more often independent directors in comparison to male directors. Thus, I hypothesize that the fraction of female directors in the board is positively related to board independence.

H9: Board independence is positively related to the ratio of female directors in the board.

4.10 Tenure

As IDs tend to have longer tenure in the board, the information gap generally subsides and IDs become more acquainted with the operations and governance of the firm by getting more exposure to inside information. Thus over time, IDs can pile up their firm specific knowledge and information (Vance, 1983) which, in turn, enhances their commitment and dedication to the firm as well as improves ID competence (Buchanan, 1974). Thus longer tenure may be expected to have favorably affected independence. Contrary to this view, (Vafeas, 2003) argues that the longer an ID serves in a board, the more personal connections he develops with management and their relationship becomes cozy. This perspective holds the view that the longer the tenure, the more the possibility of independence being compromised and the easier it is for management to capture the ID. Consequently, regulators, advocate of governance and many large institutions hold a skeptical view of IDs serving longer tenure. Consistent with this 'Compromise view', CG guidelines issued by SEC in 2012 calls for rotation of IDs after only one renewal of the 3 year serving period. So, a more rational hypothesis is the possibility of a positive or negative association between board independence and the tenure of independent director.

H10: Board independence is associated with tenure of the independent directors.

4.11 Relationship with the firm

Whether or not an ID is already related with the firm is an important factor that tentatively is expected to affect the degree of actual independence an ID can subsequently demonstrate. Moody's considers that prior connection with firm or even with other directors or management of the firm is a sign of a potential compromise with freedom for independent directors. But this doesn't necessarily always constitute a hindrance to independence. Rather, it is argued that some sort of relationship with the firm, as long as it is not extensive enough to capture the independence of the directors, is good for the improvement of monitoring activity on the part of an ID. This is backed by the fact that firm specific knowledge is important for an ID to ensure that the loopholes management uses to maximize self-interest at the cost of owners are better mended. And such expertise often requires a mild connection of independent directors with the firm. Moreover, if an ID is a total alien to the firm, chances are there that he will find it monotonous to execute his duties with genuine and diligent interest. As a consequence, different acts and governance guidelines often allow a small stake of the ID in the firm (i.e. 2012 SEC CG notification allows an ID to hold less than 1% of the paid up capital of the firm). Thus, we don't ascertain the sign but instead hypothesize the following with respect to ID prior relation with the firm in general:

H11: Board independence is related to prior relationship of independent directors with firm.

5. Research Design

5.1 Sample Description and Data Collection

In order to test the hypotheses, we have used a sample of 30 (thirty) listed banks from the banking sector of Bangladesh that constitutes with a total 56 banks classified into 6 state-owned banks, 2 specialized banks, 39 private commercial banks and 9 foreign commercial banks. Even though our sample constitutes 53.57 % of the total number of banks (excluding Bangladesh Bank), it covers all the banks that are listed in Dhaka Stock Exchange (DSE).

We resort to secondary source while collecting the data required for the study. All data come from the published annual reports of the banks which are publicly available. In order to collect the data we have extensively analyzed the annual reports of the banks from the period 2006 (when for the first time SEC issued the corporate governance guidelines) to 2016 (which is the latest year for which annual reports are available online for all the banks).

As mentioned earlier, several factors motivate us to choose the banking sector as the field of analysis in this study. Among them, the most important factor was the stringent regulation that the banking sector is subject to. Banks in Bangladesh are under extensive regulatory pressure and strict monitoring as they, unlike most other business, employ greater amount of public wealth and trust. In order to retain the confidence and faith of the greater mass of the country, the regulatory agencies and the government must find some path to ensure superior governance,

transparency, and accountability in this sector. Thus we expect banks to have a more sound set of governance mechanisms than do other sectors. With this expectation, the results of this study must have significant bearing for several parties including the government, regulators (Bangladesh Bank, BSEC etc.), management, as well as the general public who engage in day to day transactions with and take services of the banks. Finally, the results of the analysis done with the most strictly controlled banking sector might be a benchmark for deducing how well or bad the other sectors might be doing in appointing independent directors.

5.2 Variable Definition

Table II, summarizes the dependent and all the independent variables of the model we develop and also includes their definition as well as the expected nature of relationship with board independence:

Table II: Description of the research variables

<i>Variables</i>	<i>Acronym</i>	<i>Definition</i>	<i>Expected Sign</i>
Dependent Variable			
Board Independence	BODIND	Total number of independent directors divided by total number of board members	
Independent Variables			
Knowledge and Power	KNG	Dummy variable that takes 1 if all the IDs in the board have the knowledge required by SEC Notification 2012, and 0 otherwise	+
Firm Size	SIZE	Natural log of total assets	+
Financial Leverage	LEV	Total liabilities to total assets ratio	+
Growth Opportunities	MB	Ratio of market value of equity to book value of equity	-
Profitability	ROA	Net profit divided by average total assets	+
Firm Age	AGE	Natural log of the age of the firm	-
Board Size	BOD	Number of members of the board of directors.	+/-
Board Meetings	BMT	Number of board meetings held in the reporting year	+/-
Board Gender Diversity	GEN	Proportion of female directors in the board	+
Tenure	TNR	A dummy variable that takes 1 if any ID in the board has served for 6 or more years, and 0 otherwise	+/-
Relationship with Firm	REL	A dummy variable that takes 1 if any ID in the board is related to either the firm, management or other directors, and 0 otherwise.	+/-

5.3 Regression model and estimation method

Using all the identified variables we develop and estimate an econometric model to determine the significant factors likely to affect the board independence in the banking sector of Bangladesh. The regression model is as follow:

$$BODIND = \alpha + \beta_1 KNG + \beta_2 SIZE + \beta_3 LEV + \beta_4 MB + \beta_5 ROA + \beta_6 AGE + \beta_7 BOD + \beta_8 BMT + \beta_9 GEN + \beta_{10} TNR + \beta_{11} REL + \varepsilon$$

Before estimating the multivariate regression model, we examine the “multicollinearity effect” using Pearson’s correlation matrix and VIF. Both methods ensure that the model has not been unnecessarily extended by considering variables that capture homogenous concepts. Since data structure of this study corresponds to panel data covering thirty listed banks over eleven years period, we run both pooled OLS regression and robust regression with observations being clustered into firm level and year level (known as two-way clustering) to take into consideration both the cross-sectional and the time series nature of the data and to control for heteroskedasticity. The two-way clustered method adjusts the standard error of the pooled OLS method to reflect cross-sectional and time-series relation of the data. However, the robust clustered regression doesn’t differ significantly from the pooled OLS multivariate regression except for two variables. The results of estimation are described in the next section.

6. Discussion of Empirical Results

6.1 Descriptive Statistics

Table III summarizes the descriptive statistics for the variables used in the regression model. According to the table, on an average 62% of the independent directors serving in the board of the banking companies in Bangladesh have the educational qualifications required by BSEC guidelines for corporate governance. The average total asset of the firms is found to be 99,707.88 million BDT and the mean leverage of the firms is 93%, a very high one and is justified because of the nature of the industry. On average, a share is traded at 2.5 times high compared to its book value and return on asset is 1.3 percent. Around 18% of the IDs are somehow related to the firms they are serving indicating a probable and harmful nexus between management and ID under the compromise view of CG. But viewed from another angle, this relationship can improve the IDs knowledge about the firm and thus they have more scope to come up with value addition services to the firm by the incorporation of their firm specific knowledge and experience as well as a better sense of dedication and attachment to the welfare of the firm. In regard to board meetings, the average number is around 18 which is a decent number. We also find that average presence of female member in the board is 10% which has run to a highest of 75%. Another important finding of this study is that 8% of the IDs have either reached or exceeded the prescribed tenure mentioned by SEC that is six years at a stretch. The rest 92% of the IDs have not been in appointment for more than 2 consecutive periods.

Table III: Descriptive statistics

<i>Variables</i>	<i>N</i>	<i>Mean</i>	<i>Standard Deviation</i>	<i>Min</i>	<i>Max</i>
<i>BODIND</i>	329	0.099	.099	0	0.43
<i>KNG</i>	330	0.62	0.48	0	1
<i>SIZE*</i>	330	99707.88	2.248	12708.17	1498537.21
<i>LEV</i>	330	0.93	0.11	0.009	1.76
<i>MB</i>	329	2.46	4.23	-0.43	36.47
<i>ROA</i>	329	0.013	0.02	-0.23	0.23

<i>AGE</i>	330	10.28	2.46	0	33.12
<i>BOD</i>	330	13.19	1.36	4.95	27.93
<i>BMT</i>	329	17.63	1.16	3.98	61.56
<i>GEN</i>	330	0.10	0.11	0	0.75
<i>TNR</i>	330	0.08	0.27	0	1
<i>REL</i>	330	0.18	0.39	0	1

* Figure is in million BDT

Finally, the degree of board independence as measured by their proportion in the board is found to be 10% on average which runs as high as 43% while there are boards with no ID and apparently no board independence. This phenomenon actually was prevalent in the banking sector during the period of 2006 to 2008 in most of the banks due to the lack of a stringent rule requiring independence in the board. But the situation dramatically improved after the 2012 revised notification on CG issued by BSEC. Still, Bangladesh is lagging behind in ensuring the proper representation of independence from the ID mechanism as long as the suggestion of Raghunandan and Rama (2007) is concerned that calls for at least 50% of the board to be represented by non-executive directors to ensure sound governance of the firm.

6.2 Correlation Analysis

Before moving into the main analysis, we check the Pearson correlation coefficient among the variables. The following table (Table IV) reports the presence of no independent variables in the model that has significant relationship with any other variables here. This univariate correlation suggests that board independence is positively and significantly correlated with knowledge of independent directors, firm size, firm age, gender diversity, tenure of independent directors and their relationship with the firm while board independence has significant negative relationship with market to book ratio and board size. However, no significant relation is found for financial leverage, operating performance and number of board meetings.

Table IV: Pearson Correlation Coefficient

	1	2	3	4	5	6	7	8	9	10	11	12
1	1											
2	0.57	1										
3	0.11	-0.04	1									
4	0.55	0.51	-0.01	1								
5	-0.02	-0.02	0.01	-0.38	1							
6	-0.17	-0.07	-0.09	-0.16	-0.03	1						
7	-0.04	0.04	0.03	0.09	-0.40	0.12	1					
8	0.15	0.32	-0.28	0.49	0.06	-0.09	-0.05	1				
9	-0.20	-0.10	-0.13	0.25	-0.38	-0.02	0.21	0.07	1			
10	0.01	0.18	-0.03	0.32	-0.30	0.05	0.18	0.33	0.23	1		
11	0.37	0.20	0.07	0.25	-0.06	-0.05	0.009	0.09	-0.05	0.03	1	
12	0.38	0.16	0.09	0.15	-0.06	-0.07	0.01	-0.05	-0.00	0.02	0.22	1

1. BODIN 2. KNG 3. GEN 4. SIZE 5. LEV 6. MB 7. ROA 8. AGE 9. BOD 10. BMT 11. TNR 12.REL

6.3 Result of Multivariate Analysis

We estimate the regression model using both pooled OLS method and two-way clustered method. While the results do not differ significantly, we report only the results of clustered regression analysis since this method corrects the standard errors for possible relation among variables across firms and over time commonly detected in panel data setting, and produces more robust and conservative standard errors. The results are presented in table V. We find the F-statistic of the model developed in this study to be highly significant ($F=44.94$, $P < 0.0001$) indicating overall significance of the model. Both R^2 and adjusted R^2 have reasonably high values respectively being 0.63 and 0.59. This is an indication that around 59% of the total variation in board independence can be explained by the set of independent variables used in the model. Moreover, the low value of Root MSE indicates greater accuracy of the model.

Table V: Results of Multivariate Regression
(Linear regression with two-way clustered SEs)

Variable	Expected sign	Coefficient	Standard error	t-statistic	$P > t $
Intercept		-0.52352***	0.15077	-3.47	0.001
KNG	+	0.05663***	0.01176	4.82	0.000
SIZE	+	0.06642***	0.01368	4.86	0.000
LEV	+	0.09101**	0.03605	2.52	0.012
MB	-	-0.00130	0.00085	-1.53	0.127
ROA	+	-0.04865	0.15657	-0.31	0.756
AGE	-	-0.01829***	0.00695	-2.63	0.009
BOD	+/-	-0.07210**	0.02955	-2.44	0.015
BMT	+/-	-0.01565*	0.00819	-1.91	0.057
GEN	+	0.01666	0.04788	0.35	0.728
TNR	+/-	0.04996**	0.02465	2.03	0.044
REL	+/-	0.05526***	0.00989	5.59	0.000

N	329	Number of clusters (firm)	30
F-statistic (11, 317)	44.94	Number of clusters (year)	11
Prob. > F	0.0000	Root MSE	0.0615
R-square	0.63		
Adj. R-square	0.59		

***, **, * represents significance level at 1, 5 and 10 percent respectively.

The results indicate that board independence has significant positive relationship with ID knowledge, firm size, leverage, tenure and ID relationship with the firm. These results are in line with the hypotheses that -

- A board is likely to be more independent when independent directors have relevant skill and knowledge as required by prevailing corporate governance regulation. [Fogel, Ma, and Morck (2014)]
- Bigger firms employ more independent directors in order to ensure that a stringent monitoring role is carried out by them (Klein, 2002)
- Greater leverage turns out to be a reason for demanding stringent monitoring by creditors which in turn requires more independence in the board.

- Longer tenure enhances the firm specific knowledge of the independent directors (Vance, 1983) and this in turn improves the dedication and commitment of the ID to the firm as well as improves competence (Buchanan, 1974).
- The positive association between board independence and the existence of any relationship between the ID and the firm might be explained by fact that some sort of attachment with the firm is necessary for the part of the ID in order for them to have a greater degree of care for the sound governance of the firm. If IDs do not at all have any sort of relationship or attachment with the firm they serve in, it would be a dull responsibility for them to carry out and they would apparently lose interest in executing their duty properly.

On the other hand, this study finds significant negative relationship of board independence with firm age, board size and board meetings. Over times, older firms tend to develop more efficient internal control and monitoring systems that are apt in ensuring sound governance. The capability of older firms to demonstrate much maturity in controlling management's ability to extract private benefit (i.e. in the form of using up free cash flow for office amenities) from the firms leads to a lower demand on the board independence as a mainstream governance mechanism. Thus, matured firms develop stronger substitutes to ID and the negative association of firm age with board independence seems a fairly justified one. Similarly, the negative association of board size and board activity with board independence suggests that these board characteristics seem to work against board independence. One possible explanation might be that a firm is less likely to appoint new independent directors in response to increase in the number of board members or board meetings.

However, this study doesn't find any significant relationship of board independence with growth opportunities, profitability and gender diversification (presence of female members) in the board. The coefficients on these three variables are not statistically significant at the conventional level. Thus, this study indicates that growth opportunities (as measured by market to book ratio), firm profitability (as measured by ROA) and gender diversity (as measured by the proportion of female directors on the board) do not materially affect board independence in the banking sector of Bangladesh.

7. Conclusion

This study has attempted to identify the determinants of board independence measured by proportion of independent directors on the board in the banking sector of Bangladesh. This examination has applied a panel data analysis for DSE listed 30 scheduled banks that deliver the information necessary for analysis from 2006 to 2016. The results of this study show that boards tend to be more independent when they have independent directors with relevant skill and educational background. Firm specific factors that positively influence the independence of the board are larger size of firms and a relatively higher financial leverage. This study reports that board structure plays an important role in determining the level of board independence. Another vital finding conveys that the greater the board size, the lower is its independence. Contrary to the tentative expectation, longer tenure and relationship of independent directors with the firm have been found to enhance independence instead of decaying it. But it would be wise to be cautious in interpreting this result because too much increase in these two variables might create hindrance to independence. Finally, this study doesn't find any statistically significant relationship of board independence with profitability, growth opportunities of the firm and gender diversification in the board. Finally this paper confines its focus to the determinants of board independence without attempting to explain or predict the consequences of such. The concept of independent director has attained extensive popularity and importance in ensuring proper functioning of the board and other internal governance mechanisms in a firm. Thus this study might be helpful in undertaking future research such as determining various regulatory and performance implications of this concept, testing the attributes of independent directors with firm performance, examining the usefulness of having more independent boards and so on.

References

- Abdullah S., Abidin N.Z., Bakar I.A. and Rahman, A. (2016), "The Appointment Process for Independent Directors in Malaysian Listed Companies", *Corporate Ownership and Control*, 14(1).
- Adhikary, B. and Mitra, R. (2016), "Determinants of Audit Committee Independence in the Financial Sector of Bangladesh", *Applied Finance and Accounting*, 2(2), pp. 46.
- Al-Najjar, B. (2011), "The Determinants of Audit Committee Independence and Activity: Evidence from the UK", *International Journal of Auditing*, 15(2), pp.191-203.
- Altuwajri, B. and Kalyanaraman, L. (2016), "Is Excess Board Independence Good for Firm Performance? An Empirical Investigation of Non-Financial Listed Firms in Saudi Arabia", *SSRN Electronic Journal*.
- Aspris, A. and Frino, A. (2011), "Board Independence, Stock Liquidity, and Price Efficiency", *SSRN Electronic Journal*.
- Bainbridge, S. (2002), "A Critique of the NYSE's Director Independence Listing Standards", *SSRN Electronic Journal*.
- Balasubramanian, B. (2017), "Director Independence in Controlled Companies - The Way Forward", *SSRN Electronic Journal*.
- Bhagat, S. and Black, B. (1998), "The Non-Correlation Between Board Independence and Long-Term Firm Performance", *SSRN Electronic Journal*.
- Ltd, A. (2018), "The importance of independent directors", *Times of Malta*. Available at: <https://www.timesofmalta.com/articles/view/20140213/business-comment/The-importance-of-independent-directors.506609> [Accessed 16 Feb. 2018].
- Brickley, J., Coles, J. and Terry, R. (1994), "Outside directors and the Adoption of Poison Pills", *Journal of Financial Economics*, 35(3), pp. 371-390.
- Broughman, B. (2008), "The Role of Independent Directors in VC-Backed Firms", *SSRN Electronic Journal*.
- Byrd, J. and Hickman, K. (1992), "Do Outside Directors Monitor Managers?", *Journal of Financial Economics*, 32(2), pp. 195-221.
- Cai, Y., Xu, J. and Yang, J. (2016), "Affiliated Corporate Donations and Director Independence", *SSRN Electronic Journal*.
- Chatterjee, D. (2009), "Independent Directors and Current Legal Perspectives in India", *SSRN Electronic Journal*.
- Chen, L. and Moers, F. (2011), "The Market for Independent Directors", *SSRN Electronic Journal*.
- Clarke, D. (2006), "Setting the Record Straight: Three Concepts of the Independent Director", *SSRN Electronic Journal*.
- Clifford, P. and Evans, R. (1997), "Non-Executive Directors: A Question of Independence", *Corporate Governance*, 5(4), pp.224-231.
- Cohen, L., Frazzini, A. and Malloy, C. (2009), "Hiring Cheerleaders: Board Appointments of 'Independent' Directors", *SSRN Electronic Journal*.
- Cukurova, S. (2014), "What Do Outside Directors Learn Around Annual Meetings? Evidence from Insider Trading", *SSRN Electronic Journal*.
- Dou, Y., Sahgal, S. and Zhang, E. (2015), "Should Independent Directors Have Term Limits? The Role of Experience in Corporate Governance", *Financial Management*, 44(3), pp. 583-621.
- Ebrahim, A. and Black, H. (2013), "Board Independence Impact on Insider Trading, Before and After SOX", *SSRN Electronic Journal*.
- Ey.com. (2018)., "Role of Independent Directors in Corporate Governance", *EY India* [online] Available at: <http://www.ey.com/in/en/services/assurance/fraud-investigation---dispute-services/corporate-governance--role-of-independent-directors> [Accessed 16 Feb. 2018].
- Fama, E. (1980), "Agency Problems and the Theory of the Firm", *Journal of Political Economy*, 88(2), pp. 288-307.
- Fama, E. and French, K. (1992), "The Cross-Section of Expected Stock Returns" *The Journal of Finance*, 47(2), p. 427.
- Fama, E. and Jensen, M. (1998), "Separation of Ownership and Control", *SSRN Electronic Journal*.
- Fogel, K., Ma, L. and Morck, R. (2014), "Powerful Independent Directors", *SSRN Electronic Journal*.
- Germain, L., Galy, N. and Lee, W. (2012), "The Determinants of Corporate Board Size and Independence: Evidence from Malaysia", *SSRN Electronic Journal*.
- Gutierrez, U.M. and SaezLacave, M. (2012), "Deconstructing Independent Directors", *SSRN Electronic Journal*.
- Jenwittayaroje, N. and Jiraporn, P. (2017), "Do Independent Directors Improve Firm Value? Evidence from the Great Recession", *International Review of Finance*.
- Johanson, D. and Ostergren, K. (2010), "The Movement Toward Independent Directors on Boards: A Comparative Analysis of Sweden and the UK", *Corporate Governance: An International Review*, 18(6), pp. 527-539.

- Kang, S. (2013), "Experienced Independent Directors", SSRN Electronic Journal.
- Kanagaretnam, K., Lobo, G. and Whalen, D. (2013), "Relationship between Board Independence and Firm Performance Post Sarbanes Oxley", *Corporate Ownership and Control*, 11(1).
- Keasey, K. and Hudson, R. (2002), "Non-executive Directors and the Higgs Consultation Paper, Review of the Role and Effectiveness of Non-executive Directors" *Journal of Financial Regulation and Compliance*, 10(4), pp.361-371.
- King, R. and Peng, Q. (2007), "Does the Reputation of Independent Non-Executive Directors Matter: Evidence from Hong Kong", SSRN Electronic Journal.
- Klein, A. (1998), "Firm Performance and Board Committee Structure", *The Journal of Law and Economics*, 41(1), pp. 275-304.
- Kossoff, K. (1983), "Director Independence and Derivative Suit Settlements", *Duke Law Journal*, 1983(3), p. 645.
- Kumar, N. and Singh, J. (2012), "Outside Directors, Corporate Governance and Firm Performance: Empirical Evidence from India", *Asian Journal of Finance & Accounting*, 4(2).
- Lai, B. (2014), "Are Independent Directors Effective Corporate Monitors? An Analysis of the Empirical Evidence in the USA and Canada", SSRN Electronic Journal.
- Laux, V. (2008), "Board Independence and CEO Turnover", *Journal of Accounting Research*, 46(1), pp. 137-171.
- Liu, W. (2011), "Board Independence and Long-Term Firm Performance: The Initial Quest of Effective Board Paradigm - A Survey Based on Nonlinear Regression Equation Modeling", SSRN Electronic Journal.
- Ltd, A. (2018), "The importance of independent directors", *Times of Malta*, Available at: <https://www.timesofmalta.com/articles/view/20140213/business-comment/The-importance-of-independent-directors.506609> [Accessed 16 Feb. 2018].
- Ma, J. and Khanna, T. (2015), "Independent directors' dissent on boards: Evidence from listed companies in China", *Strategic Management Journal*, 37(8), pp. 1547-1557.
- McLean, R. (1997), "Agency Problems, Equity Ownership, and Corporate Diversification", *CFA Digest*, 27(4), pp. 49-51.
- Nguyen, T., Evans, E. and Lu, M. (2017), "Independent directors, ownership concentration and firm performance in listed companies", *Pacific Accounting Review*, 29(2), pp. 204-226.
- Peecher, M., Rowe, S. and Sivadasan, P. (2015), "Are All Outside Directors Independent? An Investigation of the Compliant Director Market", SSRN Electronic Journal.
- Pichet, E. (2013), "Defining and Selecting Independent Directors", SSRN Electronic Journal.
- Podder, J., Skully, M. and Brown, K. (2013), "Independent Directors and Risk Taking: Evidence from Listed US Insurance Companies", SSRN Electronic Journal.
- Ramdani, D. and Witteloostuijn, A. (2010), "The Impact of Board Independence and CEO Duality on Firm Performance: A Quantile Regression Analysis for Indonesia, Malaysia, South Korea and Thailand", *British Journal of Management*, 21(3), pp. 607-627.
- Ravina, E. and Sapienza, P. (2008), "What Do Independent Directors Know? Evidence from Their Trading", SSRN Electronic Journal.
- Santella, P., Drago, C. and Paone, G. (2007), "Who Cares About Director Independence?", SSRN Electronic Journal.
- Santella, P., Paone, G. and Drago, C. (2006), "How Independent are Independent Directors? The Case of Italy", SSRN Electronic Journal.
- Stein, G. and Plaza, S. (2011), "The Role of the Independent Director in CEO Supervision and Turnover", *Corporate Ownership and Control*, 9(1).
- The Report of the Cadbury Committee on the Financial Aspects of Corporate Governance: The Code of Best Practice, (1993), *Corporate Governance: An International Review*, 1(3), pp.124-124.
- Wan, K. (2003), "Independent Directors, Executive Pay, and Firm Performance", SSRN Electronic Journal.
- Wang, Y. and Young, A. (2010), "Does Firm Performance Affect Board Independence?", *Corporate Board: Role, Duties and Composition*, 6(2).
- Ye, K. (2014), "Independent Director Cash Compensation and Earnings Management", *Journal of Accounting and Public Policy*, 33(4), pp. 391-400.
- Zhang, X. and Zhou, F. (2010), "How Do Companies Adjust their Independent Directors after a Mishap - Evidence from Independent Directors' Background", *Journal of Service Science and Management*, 03(03), pp. 336-344.



The Effect of Specific Factors on Bank Profitability: Evidence from Nepalese Banks

Prem Bahadur Budhathoki¹, Chandra Kumar Rai²

¹Mahendra Multiple Campus, Dharan, Tribhuvan University, Nepal

²Mahendra Multiple Campus, Dharan, Tribhuvan University, Nepal

Correspondence: Prem Bahadur Budhathoki, Mahendra Multiple Campus Dharan, Tribhuvan University, Nepal.
Tel: 977-025521546 Email: pravabbudhathoki@gmail.com

Abstract

This paper examines the impact of assets quality, capital adequacy ratio, assets diversification and operating efficiency on banks' profitability. This study employs bank scope data of eight commercial banks during the period of 2002/03 – 2016/17. Altogether, there are 96 observations are made in the study. The ordinary least squares model is used to analyze the data. The results indicate that three predictor variables assets quality, operating efficiency, and capital adequacy ratio significantly affect bank profitability. But the predictor variable diversification does not affect banks' profitability significantly. The results of this study help the bankers and policymakers to take effective action in order to improve banks' profitability.

Keywords: Capitalization, Asset Quality, Operating Efficiency, Bank Diversification

1. Introduction

Nepal government initiated financial rector reform in the mid-1980s and had implemented a comprehensive financial sector program in 2001 (Shrestha, 2004). The objectives of these reforms were to create an efficient, competitive, transparent, discipline and profitable banking sector to foster economic growth of the nation. Since the liberalization, the Nepalese financial sector widened. The elimination of government intervention and private sector participation has significantly contributed to this expansion (Bhetuwal, 2007). This widened financial sector brings a large number of financial institutions and has created intense competition among them (Panta, 205). The fierce competition within financial institutions brings both opportunities and threats to the economy. Intense competition within financial institutions may increase or decrease the banks' profitability. While the banks cannot generate sufficient profit to run the business, then they become insolvent and increase financial instability. Further, it brings contaminate effects in the financial system. When any financial institution develops serious problems that reach public notice, the public's confidence in other financial institutions may be damaged as well (Rose, 2002). The results may be serious due to the smaller flow of saving to investment which adversely affects the job opportunity and economic growth rate. Nepal has a bank dominated economy (Kharel & Pokhrel,

2012). The role of banking sectors in bank dominated economy is more than the capital dominated economy. The success of the commercial banking sector plays a key role in promoting economic growth in Nepal. Therefore, Profit is essential to survive in the long-run. There are two important conflicting paradigms regarding the banks' profitability: Structure-Conduct-Performance (SCP) hypothesis and Efficient Structure (ES) hypothesis. On the one hand, the SCP hypothesis argues that a smaller number of firms operating in the market have the ability to obtain higher profit through the collusion among banks. In other words, they can obtain more profit by charging higher loan rates and offering low deposit rates (Tan & Floros, 2014). On the other hand, ES structure hypothesis argues that efficient banks can produce large varieties of service products at a lower cost, able to compete more aggressively in the competitive market, capture a bigger market share (Tan & Floros, 2014) allow banks to increase their size (Curak, Poposki & Pepur, 2012) and get an advantage of economies of scale to earn high profit. Similarly, there are two contrasting views regarding the association between capital and profitability. On the one hand, the signaling hypothesis states that the high capital of banks conveys positive signals in the market. If the debtors and depositors take it positively then the cost of funds might decrease and banks' profit increases.

Banks with higher capital are capable of absorbing any negative shocks and assumed to possess less insolvency. Higher capital may also incentivize shareholders to monitor management activities; therefore lower the probability of taking an excessive risk by managers (Ahemed, 2017). On the other hand, the risk-return hypothesis states that there is a direct relationship exist between risk and return; a higher capital ratio decreases the risk of the firms and leads to lower performance of the banks. Additionally, the trade-off theory states that greater the use of debt (lower the use of equity) increases the banks' interest expenses and the bank may not able to meet its financial duties on time. Consequently, the required rate of return on new capital will increase and the probability of bankruptcy cost also increases which reduce bank profitability (Saona, 2016).

Basically, it can be expected that there is a positive relationship between asset quality and bank performance. In other words, there is an inverse relationship existing between provision for loan loss ratio and ROA and NIM. Bank asset quality has been responsible for the success or failure of the bank. The best measure for assessing the quality of assets is loan loss provisions to loan ratio. Loan loss provision is the ratio of the loan loss provisions to loans, a measure of the quality of loans granted by banks (Damtsa, Milidonis, & Stathopoulos, 2019). There are two contrasting facts regarding the relationship between asset quality and banks' profitability. On the one hand, some scholars argue that the decreases of assets quality increase the proportion of non-performing assets, possible loan loss provision and monitoring cost of the banks; which leads to a decrease in banks' profitability. On the other hand, some scholars argue that the decreases of assets quality increase the loan loss provision, and increase default loss which can be compensated through higher interest margin because high risk should pay high prices to the banking services (Saona, 2016).

Basically, it can be expected that there is an inverse relationship between operating efficiency (lower cost to income ratio) and bank performance. There are two contrasting facts regarding the relationship between operating efficiency and banks' profitability. On the one hand, it can be expected that the operating cost is positively related to bank profitability with regards to ROA and NIM. This statement can be explained by the fact that profit is the difference between total revenue and total cost which clearly states that high operating cost reduces the banks' profitability. On the other hand, opponents of this arguments states that large volume of operating expenses is derived from paying salaries and wages to staff, while higher levels of salaries and wages paid to staff significantly improve the staff productivity, while the resulting improvement in the bank profitability is much larger than the salaries and wages paid out by the bank (Tan, 2016). In other words, the higher level of wages and salaries increase the employees' loyalty, decrease the supervision cost, and attract high-quality workers to the banks. All the factors that impact banks' profitability mainly studied in developed and developing countries but very few kinds of literature are found in the context of low-income countries such as Nepal. Therefore, the aim of this study is to examine the impact of capitalization, asset quality, operating efficiency, and bank diversification on the profitability of Nepalese commercial banks.

2. Literature Review

2.1 Capitalization and bank profitability

Bank capital is considered as one of the important factors affecting bank profitability. The bank's equity capital directly influences the rate of return on equity. The leverage ratio can affect the growth rate of the bank also. In the extreme, if losses exceeded bank capital, the bank would be insolvent and subject to closure by the chartering agency (Gup & Kolari, 2012). The capital fund of the commercial bank plays several roles: first, it protects banks from insolvency risk. Second, capital promotes public confidence in a bank and reassures its creditors (including depositors) of the bank's financial strength. Third, the capital provides funds for the organization's growth and development of new services, programs, and facilities. Fifth, capital serves as regulators of bank growth. Finally, it protects the government's deposit insurance system from series losses (Rose, 2002). Existing literature reveals two contrasting empirical pieces of evidence of capitalization on bank profitability. In the one extreme, it is expected that there is direct association between capital ratio and bank's profitability because it reduced the funding cost due to the fact that it increases banks' creditworthiness; the banks with higher capital levels are more likely to engage in prudent lending; capital plays an important role in absorbing the risk arising from higher-risk assets, such as loans; and the banks with higher capital levels need to borrow less, which reduce cost and further increases profitability (Tan, 2016). A study conducted by Trad, Trabelsi, & Goux in 2017 entitled 'Risk and profitability of Islamic banks: A religious or an alternative solution?' and found a positive and very significant effect of capital on banks' profitability. They argued that a significant level of capital makes for better protection against banking crises. In light of these results, it seems that capital adequacy was a safety valve and a guarantee of bank profitability and stability. Therefore, the bank should maintain a minimum capital to ensure sufficient funds against unexpected losses and negative shocks (p. 43). Similarly, Ahamed in 2017 found that larger banks, greater equity capital, and greater composition of assets in the form of loans are positively and significantly associated with profits and risk-adjusted assets. But a study conducted by Patria, Capraru & Ihnatov in 2015 entitled 'Determinants of banks' profitability: Evidence from EU 27 banking system' and found an insignificant relationship between capital adequacy ratio and shareholders' return. They argued that a high capital adequacy ratio may reduce the risk of the banks but at the same time they would not get the benefit of the leverage effect. In another extreme, Saona in 2016 found a negative relationship between the bank's performance and capitalization ratio. This result can be explained by the fact that the high capital ratio decreases both the risk of the banks and tax subsidy form interest expenses. Overly conservative management might not be taking advantage of certain market opportunities and consequently experiencing lower performance (Saona, 2016). The third line of empirical evidence advocates that there is no relationship between capital adequacy ratio and banks' profitability. A study conducted by Bhattarai in 2016 found an insignificant association capital adequacy ratio and Nepalese banks' profitability. A similar result was found by Dietrich, & Wanzenried in 2014 in low-and-middle countries. This result can be explained by the fact that they did not able to generate more loans and absorb more losses and fail to support the regulator's recapitalization policy.

2.2 Asset quality and bank profitability

Existing literature reveals two contrasting empirical shreds of evidence on the impact of capitalization on the bank's profitability. Asset quality also directly influences the rate of return on assets. (Gup & Kolari, 2012). The quality of assets can be deteriorated due to the high competition within financial institutions. On the one hand, it can be argued that the decreases in assets quality increase the proportion of non-performing assets, possible loan loss provision and monitoring cost of the banks; which leads to a decrease in banks' profitability. So, it can be expected that there is a positive relationship between asset quality and the bank's performance. In other words, there is an inverse relationship exist between provision for loan loss ratio and ROA and NIM. A study conducted by Patria, Capraru & Ihnatov in 2015 entitled 'determinants of banks' profitability: Evidence from EU 27 banking system' and found an inverse and statistically relationship between provision for loan losses to loan ratio and banks profitability. It means that the higher this ratio, the lower the banks' profitability and vice versa. In other words, the quality of the asset directly affects the bank's profitability. A similar result was found by Bhatta in 2015 argued that an increase in loan loss of the bank results in a decline in owners' equity and constrains the lending capacity of the bank which further reduces the amount of loan disbursement. These results can explain the fact that a low-quality ratio produces higher non-performing assets and increases loan loss

provision for protection against default loss; which leads to lower the bank's profitability. On the other hand, it can be argued that there is a positive and statistically significant relationship between LLRGL and ROA and NIM. A study conducted by Trad, Trabelsi, & Goux in 2017 entitled 'Risk and profitability of Islamic banks: A religious or an alternative solution?' and found a positive and statistically significant association between loan loss reserve to gross loan ratio (LLRGL) and ROA and ROE. This result can be explained by the fact that relaxing credit standard increases both loan loss reserves and gross loan of the banks. It also increases the banks' profitability. Basically, it can be expected that there is a positive relationship between asset quality and bank performance. In other words, there is an inverse relationship existing between provision for loan loss ratio and ROA and NIM. Bank asset quality has been responsible for the success or failure of the bank. The best measure for assessing the quality of assets is loan loss provisions to loan ratio. Loan loss provision is the ratio of the loan loss provisions to loans, a measure of the quality of loans granted by banks (Damtsa, Milidonis, & Stathopoulos, 2019). The structure- Conduct-Performance hypothesis posits that a lower competitive loan market will lead to an improvement in profitability for all three different ownership types of Chinese banks (Fang, Lau, Lu, Tan & Zhang, 2019).

2.3 Bank diversification and bank profitability

Existing literature reveals two contrasting empirical pieces of evidence of capitalization on the bank's profitability. Sources of income other than earnings from loans and securities are called simply non-interest income and usually include fees earned from offering trust department services (locker facility), service charges on deposit accounts and miscellaneous fees and charges for other bank services. Recently, bankers have targeted non-interest income or fee income as a key source of future revenues. By more aggressively selling services other than loans such as security brokerage, insurance, and trust services bankers have found a promising channel for boosting the bottom line on their income statement, for diversifying their income sources and for insulating their banks more adequately from the fluctuation of interest rate (Rose, 2002). A study performed by Tan in 2016 and found a significant and negative impact of diversification on bank profitability (NIM). It suggests that the higher level of diversified business precedes a decline in bank profitability. This result can be explained by the fact that a larger variety of businesses engaged by banks reduces the volume of funds available for traditional loan business, which precedes a decline in NIM (Tan, 2016). NIM concentrates on interest-generating activities only. While the banks engaging in the non-interest generating businesses reduces the volumes of traditional loan business, which further proceeds a decrease in NIM of commercial banks (Fang, Lau, Lu, Tan & Zhang, 2019). The results show that banks with low-asset-quality tend to generate more profits by having more non-interest sources of income. His study showed that public and private banks earn higher profits by shifting toward non-interest sources of income from the traditional interest-based income. Over the last decade asset quality of Indian banks has deteriorated continuously. Therefore, to offset the loss of traditional interest-based income, many banks have started providing interest-based, commission, and trading based activities for higher revenue (Ahmad, 2017). The fierce competition between financial institutions will bring excessive credit risk, but the regulatory body (Nepal Rastra Bank) basically discourages banks to do it. So, by generating non-income, banks can recover the loss of poor quality loans and advances. Even though, greater market powers (low competition) within the financial institutions have lower credit risk and earn more non-interest income from diversification. The greater market power might help the banks to select good customers, provides revenue growth opportunities from fee-based and commission-based new services products and enhances bargaining power to contract creation (Ovi, Peresa, & Colombage, 2014). A study conducted by Ovi, Peresa, & Colombage, in 2014 found a positive and statistically significant association between market power and non-interest income. The findings of this study can be explained by the fact that greater market power (low competition) in loans and deposit markets gives ground for growth opportunities in non-traditional income from fees and commission-based products. Income diversification has a positive impact on bank profitability in high-income and middle-income countries, but not in low-income countries. This result can be explained by the fact that margins in the traditional retail banking business are much higher for banks in low-income countries compared to banks in high-income countries; therefore income diversification in low-income countries is not beneficial because profit margin from interest income is higher than margins from fee, commission, and trading operations (Dietrich & Wanzenried, 2014).

2.4 Operating efficiency and bank profitability

Existing literature reveals two contrasting empirical pieces of evidence of capitalization on bank profitability. Operating efficiency deals with the production of outputs such as deposit and loan accounts and at a minimum cost per dollar (or account) (Gup & Kolari, 2012). Overhead cost is highly significant and positively related to bank profitability with regards to ROE, NIM, and PBT. This finding can be explained by the fact that large volume of operating expenses is derived from paying salaries and wages to staff, while higher levels of salaries and wages paid to staff significantly improve the staff productivity, while the resulting improvement in the bank profitability is much larger than the salaries and wages paid out by the bank (Tan, 2016). He found a positive relationship between operating efficiency and ROA, ROE, NIM, and PBT. Cost efficiency is found to be significantly and positively related to bank profitability, indicating that Chinese commercial banks with a higher level of cost efficiency have higher profitability (Fang, Lau, Lu, Tan & Zhang, 2019). Higher values of this variable indicate there is a higher volume of cost and further indicates that the bank does not control and manage the cost very well. On the one hand, higher volumes of operating costs without any doubt will have a negative impact on bank profitability. This argument is supported by the finding of Athanasoglou et.al. (2008) with regard to the Greek banking industry. On the other hand, this operating cost may possibly come from higher salaries and wages, and according to efficiency theory, the higher level of salary will significantly promote staff productivity, and further promote the bank's profitability (Tan, 2017).

Table 1: Description of the variables and their expected impact on bank profitability

Variables	Measurement	Expected effect
Profitability	ROA	
Capitalization	Capital adequacy ratio	-
Asset quality	Provision for the loan loss ratio	-
Operating efficiency	Cost to income ratio	-
Bank diversification	Non-interest income to gross income ratio	+

3. Variables Selection and Research Methods

3.1 Variable selection

3.1.1 Dependent variable: The main purpose of the study is to explain the impact of bank-specific variables on profitability. This study considers the mere one variable ROA as the dependent variable. This is measured by dividing net income by total assets of the bank. It is a widely used tool to measure the banks' performance.

3.1.1 The bank-specific variables: In this current study, four predictor variables are used. The first independent variable capital is measured by the capital adequacy ratio. A higher capital ratio indicates that the bank has lower risk. The second independent variable assets quality variable is measured by loan loss provision to the gross loan ratio. A higher ratio indicates poor asset quality. The third independent variable operating efficiency is measured by the total operating cost to the total operating revenue ratio. A higher ratio indicates that the bank is less efficient. Finally, the fourth independent variable diversification is measured by non-interest income to total gross income ratio. A high ratio indicates that the bank is highly diversified.

3.2 Research methods

Now 28 commercial banks are operating in Nepal. So, 28 commercial banks are considered as population. Among them, only eight commercial banks are taken as a sample by using non-probability convenience sampling. The study period was 2002/03 to 2016/17. This empirical study is based on time series panel data which is gathered through the review of quarterly and annual reports of the Nepal Rastra Bank and Ministry of Finance of Nepal. The collected time series data are analyzed using descriptive statistics, Pearson correlation coefficient, and multiple regression model. Therefore, this research employed a descriptive and explanatory research design. The average value, standard deviation, maximum, and minimum value are used to describe the characteristics of data from 2002/03 to 2016/17. The correlation matrix is used to examine the relationship between a response variable and predictor variables. The correlation matrix helps to identify the multicollinearity

problem. A common rule of thumb is that correlations among the independent variables between -0.7 to 0.7 do not cause difficulties (Lind, Marchal, & Wathen, 2006). Some statisticians assume that the correlation coefficient between predictor variables between -0.9 to 0.9 does not harm significantly. Thus, in this research, the researcher accepts those independent variables whose correlation coefficient lies between -0.9 to 0.9. Multicollinearity problem is detected based on VIF if VIF is greater than five (Titko, Skvarciany, & Jureviciene, 2015). Finally, the collected data are analyzed by using the Statistical Package for Social Sciences (SPSS).

Multiple regression models

Based on the review of the literature, to examine the relationship between the dependent variable and independent variables, the following multiple regression model has been tested.

$$ROA = a + \beta_1 (CAR) + \beta_2 (AQ) + \beta_3 (OE) + \beta_4 (D) + \epsilon_{ij}$$

Where ROA= Return on Assets, CAR= Capital Adequacy Ratio,

AQ = Assets Quality, OE = Operating efficiency, D= Diversification

4. Empirical Results and Discussions

Table 2 shows the descriptive statistics of dependent and independent variables. Table 3 shows the correlation matrix of response and predictor variables. This study mainly focuses on regression results. Table 3 shows the results of regression analysis. The regression coefficient of assets quality ($\beta = -1.64$, $p < .01$) indicates that a higher loan loss provision to the gross loan ratio result in the lower ROA to the banks. This result is similar to the expected results which are presented in table 1. This result is in line with the findings of Patria, Capraru & Itnatov (2015), however, it is in contrast with the findings of Trad, Trabelsi, & Goux (2017). The result of this regression coefficient can be explained by the fact that low-quality assets (higher loan loss to gross loan ratio) produce higher non-performing assets; increase loan loss provision for protection against default loss which eventually leads to lower the bank's profitability. Even though the loss from the relaxation of credit standard can be compensated by charging higher interest rates, the Nepalese commercial banks should supervise, and monitor the borrowers' position after granting the loan to the borrower in order to decrease non-performing assets.

Table 2: Descriptive statistics of response and predictors variables

Variables	N	Minimum	Maximum	Mean	SD
Asset Quality	96	.01	34.08	1.87	5.02
Diversification	96	-2.54	51.53	2.40	6.90
Capital Adequacy Ratio	96	-55.44	21.08	5.04	15.97
Operating Efficiency Ratio	96	0.40	2.79	1.92	3.19
ROA	96	-15.35	18.04	3.52	.917

Table 3: Correlation matrix of response and predictor variables

Variables	1	2	3	4	5
ROA	1	-.607* (.000)	.064 (.535)	.138 (.018)	-.689* (.000)
Asset Quality	-.607* (.000)	1	-.0039 (.708)	-.442* (.000)	.733* (.000)
Diversification	.064 (.535)	-.039 (.708)	1	.005 (.963)	.049 (.637)
Capital Adequacy Ratio	.138 (.018)	-.442* (.000)	.005 (.963)	1	-.493** (.000)
Operating Efficiency	-.689* (.000)	.732* (.000)	.049 (.637)	-.493* (.000)	1

Note. *Correlation is significant at the 0.01 level (2-tailed)

Table 4: Multiple regressions ROA on all predictor variables

Variables	Coefficient	t-statistics	P-value	VIF
Intercept	7.571	9.278	.000	

Asset Quality	-1.64**	-2.523	.013	2.224
Diversification	.04	1.259	0.211	1.015
Capital Adequacy Ratio	-.059*	-3.724	.000	1.346
Operating Efficiency	-7.001*	-6.144	.000	2.367
R	.755			
R ²	.570			
F	30.101*			
P-value	.000			

Note. *Correlation is significant at the 0.01 level (2-tailed), **Correlation is significant at the 0.05 level (2-tailed),

The regression coefficient of diversification ($\beta = -.04$, $p > .05$) indicates that there is an insignificant relationship between asset diversification and bank profitability. It reveals that assets diversify from traditional loan business to non-traditional business do not increase bank's profit significantly even though these two variables are positively correlated. This result is similar to the expected results which are presented in table 1. This result is in line with the findings of Tan (2016), Fang, Lau, Lu, Tan & Zhang (2019), however, it is in contrast with the findings of Ahamed (2018), Ovi, Peresa, & Colombage (2014), and Ditrich & Wanzenried (2014). This result can be explained by the fact that fee-based income and other service charges generated by the banks are too low which does not impact significantly on the bank's profitability. The regression coefficient of capital adequacy ($\beta = -.059$, $p < .01$) indicates that a higher capital adequacy ratio provides the lower ROA to the banks. This result is similar to the expected results which are presented in table 1. This result is in line with the findings of Patria, Capraru & Ilnatov (2015), and Bhattarai (2016); however, it is in contrast with the findings of Tan (2016), Trad, Trabelsi &, Goux (2017), and Ahemed (2017). The result of the study can be explained by the fact that a higher capital ratio reduces bank risk and reduces the benefit of leverage. The regression coefficient of operating efficiency (the cost to income ratio) reduces bank profitability. This result is similar to the expected results which are presented in table 1. This result is in line with the findings of Tan (2016), and Athanasoglou et.al. (2008); however, it is in contrast with the findings of Tan (2016). This result can be explained by the fact that a higher volume of operating costs reduces the bank's profitability because profit is the difference between total revenue and total cost and further it indicates that the banks are not able to control and manage cost properly.

5. Conclusion, Implication, and Limitations of the Study

Basically, bank-specific variables and microeconomic variables affect the banks' profitability. The empirical studies conducted by various researchers reveal the contradictory results that affect banks' performance. In this study, four independent variables are taken to gauge the impact of these variables on banks' profitability. This study employs ordinary least squares regression models to gauge the relationship between response and predictor variables. The model is statistically significant ($F = 30.101, < .01$) suggest that the independent variables such as assets quality, operating efficiency, and capital adequacy ratio significantly affect bank profitability. But one predictor variable named diversification does not affect banks' profitability significantly.

Nepal is a low-income country. The Nepalese banking sector is not well developed still now. This study certainly helps the banker and policymaker to take effective action in order to improve banks' profitability and stability. This study covers only four variables, therefore, further research needs to be done by including more variables including macroeconomic variables.

References

- Ahamed, M. M. (2017). Asset quality, non-interest income, and bank profitability: Evidence from Indian banks. *Economic Modeling*, 63, 1-14. <http://dx.doi.org.10.1016/j.ecomod.2017.01.016>
- Bhatta, G. (2015). Theoretical paradigm on bank capital regulation and its impact on bank-borrower behavior. *Economic Review*, 27(2), 19-34. Retrieved from https://www.nrb.org.np/ecorev/articles/Vol27-2-art2.Theoretical_Paradigm_Final.pdf
- Bhattarai, Y. R. (2016). Effects of credit risk on the performance of Nepalese commercial banks. *Economic Review*, 28(1), 41-64. https://www.nrb.org.np/ecorev/articles/vol28-1_art3.pdf

- Bhetuwal, K. R. (2007). Financial liberalization and financial development in Nepal. *Economic Review*, 16, 23-41. Retrieved from https://www.nrb.org.np/ecorev/pdffiles/vol19_art3.pdf
- Curak, M., Poposki, K., & Pepur, S. (2012). Profitability determinants of the Macedonian banking sector in changing environment. *Procedia- Social and Behavioral Sciences*, 44, 406-416. Doi.10.1016/j.sbspro.2012.05.045
- Damtsa, S. M., Milidonis, A. & Stathopoulos, K. (2019). National culture and bank risk-taking. *Journal of Financial Stability*, 40, 132-143. <http://dx.doi.org.10.1016/j.jfs.2017.08.007>
- Dietrich, A. & Wanzenried, G. (2014). The determinants of commercial banking profitability in low-, middle-, and high-income countries. *The Quarterly Review of Economics and Finance*, 54, 337-354. <http://dx.doi.org.10.1016/j.qref.2014.03.001>
- Fang, J., Lau, C. M., Lu, Z., Tan, Y., & Zhang, H. (2019). Bank performance in China: A perspective from bank efficiency, risk taking and market competition. *Pacific- Basin Finance Journal*, 56, 290-309. <http://dx.doi.org.10.1016/j.pacfin.2019.06.011>
- Gup, B. E. & Kolari, J. W. (2012). *Commercial banking: The management of Risk*. New Delhi: Willey India (p) Ltd.
- Kharel, R. S. & Pokharel, D. R. (2012). Does Nepal's financial structure matter for economic growth? *Economic Review*, 24 (2), 31-46. Retrieved from https://www.nrb.org.np/ecorev/pdffiles/vol24-2_art3.pdf
- Lind, D. A. , Marchal, W. G., and Wathen, S. A. (2006). *Basic statistics for business and statistics*. New York: McGraw Hill.
- Neupane, B. P. (2015). Role of financial development in economic growth in Nepal. *Economic Review*, 27(1), 1-16. Retrieved from <https://www.nrb.org.np/ecorev/index.php?vid=27-1>
- Ovi, N. Z., Perera, S., & Colombage, S. (2014). Market power, credit risk, revenue diversification, and bank stability in selected ASEAN countries. *South East Asia Research*, 22 (3), 399-416. Retrieved from www.jstor.org/stable/43818537
- Petria, N., Capraru, B., & Ilnatov, I. (2015). Determinants of banks profitability: Evidence from EU 27 banking systems. *Procedia Economics and Finance*, 20, 518-524. Doi.org.10.1016/S2212-5671(15)00104-5
- Pouroush, J., & Schreiber, B. Z. (2019). Profitability, capital, and risk in US commercial and saving banks: Re-examination of estimation methods. *The Quarterly Review of Economics and Finance*. <http://dx.doi.org.10.1016/j.qref.2018.12.007>
- Rose, P. S. (2002). *Commercial bank management*. New York: McGrawHill Companies.
- Saona, P. (2016). Intra-and extra-bank determinants of Latin American Banks' profitability. *International Review of Economics and Finance*, 45, 197-214. <http://dx.doi.org.10.1016/j.iref.2016.06.004>
- Shrestha, G. K. (2004). Financial sector reforms in Nepal. *Economic Review*, 16, 75-90. Retrieved from https://www.nrb.org.np/ecorev/pdffiles/vol16_art3.pdf
- Sufian, F., & Kamarudhin, F. (2012). Bank-specific and macroeconomic determinants of profitability of Bangladesh's commercial banks. *The Bangladesh Development Studies*, 35 (4), 1-28. Retrieved from www.jstor.org/stable/41968840
- Tan, Y. (2016). The impact of risk and competition on bank profitability in China. *Journal of International Financial Markets, Institution & Money*, 40, 85-110. <http://dx.doi.org.10.1016/j.intfin.2015.09.003>
- Tan, Y. (2017). The impact of competition and shadow banking on profitability: Evidence from the Chinese banking industry. *North American Journal of Economics and Finance*, 42, 89-106. <http://dx.doi.org.10.1016/j.najef.2017.07.007>
- Tan, y., & Floros, C. (2014). Risk, profitability, and competition: Evidence from the Chinese banking industry. *The Journal of Developing Areas*, 48(3), 303-319. Retrieved from www.jstor.org/stable/24241240
- Tiko, j., Skvarciany, V., & Jureviciene, D. (2015). Drivers of bank profitability: Case of Latvia and Lithuania. *Intellectual Economics*, 9, 120-129. <http://dx.doi.org.10.1016/j.intele.2016.02.003>
- Trad, N., Trabelsi, M. A., & Goux, J. F. (2017). Risk and profitability of Islamic banks: A religious or an alternative solution?. *European Research on Management and Business Economics*, 23, 40-45. <http://dx.doi.org.10.1016/j.iedeen.2016.09.001>



An Integrated Model for Career Preferences of the Graduates in Bangladesh

Taskina Ali¹

¹ Assistant Professor, School of Business & Economics, United International University. taskina.ali@gmail.com.
Contact: 88-01715040592

Abstract

Career selection is one of the most crucial decision made by potential incumbents and graduates in the business world. This decision is generally influenced by the factors like internal (cognitive ability, emotional ability, psychomotor skills) and external environmental (socio-economic condition, academic orientation, motivational factors, urban-rural background, etc.). Little studies have been done on the employment market, job situations, the process and the factors affecting career preferences of business graduates in Bangladesh. The proposed study aims at gaining a better understanding about the career preferences of business graduates in our country. It also intends to identify and analyze the determinants of career choices and find out the relevant major determinants with particular focus on the private and public sectors of Bangladesh. More specifically the study will focus on whether career preferences by the business graduates of Bangladesh are dependent on their family income level, gender, age, educational background, geographical location, individual cognitive ability, emotional intelligence, ethics, values, types of organization and employer's characteristics. It is further intended to focus on the pattern of variation in career preferences by the business graduates vary due to educational institutional orientation. The study is exploratory in nature. The extensive literature review suggests that, the career preferences of graduates are influenced by their family orientation, educational level, emotional attachment, cognitive ability, organization's reputation, age, gender.

Keywords: Career, Career Preferences, Business Graduates, Recruitment, Employer Characteristics

1. Background

There have been good amount of theories and researches on the expectations and preferences of graduates towards their career preferences in different countries. Extensive literatures show that gender differences, age, cognitive ability, family background, educational orientation have direct effect on graduates to select their career. But more needs to be discovered whether Bangladeshi business graduates are influenced by the same factors. Graduates' profile, context, internal and external orientation of graduates, curriculum, teaching methods, style are different in different countries. Thus it is required to focus on the graduates of Bangladesh to reveal their determinants in career preferences. Career choice is such a major decision which shapes the entire professional path of graduates. Moreover, this career selection also defines the future life pattern, work-life balance, social and economic status, job satisfaction, self- actualization of any graduates. This crucial decision is not easy to make and it is not a simple

task rather without proper guidance, clear perception, professional counselling graduates may select the wrong career. In choosing career, graduates should know their self-interests, passion, basic abilities, their personal surroundings and deficiencies also. This research seeks to provide an insight on Bangladeshi business graduates' career preferences and identifying the major determinants which influences graduates' career preferences in Bangladesh. As every year more and more graduates are joining the job market of Bangladesh so this area should be highlighted and thus employer as well as potential job seekers, graduates will also be beneficial.

2. Literature Review

The word "career" is from French and Latin origin. Geciki (2002) simply defined career as; the occupational, commercial or industrial activity that a person may adopt during his educational life or in some other part or till his death. Redman and Wilkinson (2001) termed career as a process of application of one's cognitive ability, contribution to a profession over a long time and better building better business network. Adaptability, emotional intelligence, cognitive ability and other competencies have positive impact on graduates' career preferences and career success also (Amdurer, E., Boyatzis, R.E., Saatcioglu, A., Smith, M.L. and Taylor, S.N., 2014).

With increasing globalization process and the increasing number of regional trading blocs, doors are opening for business graduates to seek employment in different local, international organizations inside the home country as well as different parts of the world. In spite of the fact of global downsizing and prevailing high unemployment rate (4.2%) in Bangladesh, local business graduates are becoming quite choosy about their career offers. As more organizations are trying to find out the most talented incumbents for the vacant and newly created posts in their respective organizations, thus there is always a very competitive situation in the job market. Attracting or recruiting the right graduates for the business organization is more crucial than previous time. Graduates' emotional intelligence, communication skills, adaptation power directly influence them to choose career (Ketter, 2011). Interestingly, business graduates in Bangladesh are highly influenced by their socio-economic condition, educational background, cultural orientation (M. Rahman, 1987). Worldwide business graduates are largely affected by the job attributes like job descriptions, work environment, compensation and security packages offered by the organizations (Moy & Lee, 2002). Ngesi (2003) in his study stated that, graduates from poor socio-economic background chose those career where less trainings are required and duration of training is also short. Financial conditions of the family, social class, affordability and employability in a particular industry further influence the graduates to select their career choices (Ahmed, Sharif & Ahmad, 2017). Several studies also found that career preferences are determined by various motives and the most important motive influencing the career decision are financial success and high income (Carter, 2003), need of autonomy and independence (Van Auken, Stephens, Fry, and Silva, 2006), social recognition and status (Birley and Westhead, 1994). These aspiring young business graduates sometimes also strongly influenced by family member's decisions (Ajzen, 1991). Brown (2002) identified family members or friends' influence greatly impact the career decision-making process and the specific career path graduates opt for. As career selection is not only a challenge but also a great dilemma for the graduates, thus skills, life conditions, academic achievements are playing major role to choose right career (Ferry, 2006).

To serve the rapid expanding and new changing economy of Bangladesh, organizations are desperate to attract and retain skilled, motivated and of course diversified work force in their work premises (Morrison & Von Glinow, 1990). As business organizations are expanding in rapid rate and thus business graduates' services are required more than earlier, organization should address these graduates' preferences, expectations, and experiences. In addition, downsizing, rightsizing, horizontal structure of the organization, these factors also influence all major stakeholders towards career preferences (Fallows and Steven, 2000).

In some cases it is evident that gender is playing major role while selecting career by the business graduates (Browne 1997). In recent time, once again graduates' gender is a determinant in selecting career path (Konard, Ritchie, Lied & Corrigan 2000). Some of the researchers have exclusively focused on specific attributes, such as pay preferences (Cable & Judges 1994), and specific individual differences, like gender (Tolbert & Moen, 1998). Interestingly it is observed that higher financial benefits attracts men to accept job offer where women are influenced by social security, values, utility (Sax, 1994).

There has been a large amount of theory on how people decide which job offer to accept. One comprehensive and dynamic career theory that combines many aspects of career development is the Social Cognitive Career Theory (SSCT). The SCCT was derived from Bandura's (1977, 1986, 1997) Social Cognitive Theory, which emphasized the importance of self-efficacy in one's choice of behaviour. According to Bandura (1986), individuals choose to accept any job offer based on their self-judgment about the qualifications required to accomplishing the task. Another theory "A Social Learning Theory of Career Selection" (Krumboltz, Mitchell & Brain, 1976) identified the impact of race, gender, physical appearances, intelligence, manual coordination and nature of job opportunity in choosing career by the business graduates. In many cases it has been observed graduates accept or reject career options based on their personal strengths and weaknesses (E. Hossain & T. Siddique, 2012).

It is also observed that cultural values, individual abilities, dominance of family members have greater impact on career preferences of graduates (Tanuja Agarwala, 2008). But at the same time there are situations also when graduates accept the available job offer without waiting further for the cherished career (Alan M Saks, Blake E. Ashforth; March 1998). According to Donald P. Schwab (1982) in job market potential as well as existing job seekers consider three factors when evaluating job offer and these are objective factors (pay, location, opportunity of advancement), subjective factors (match of person's personality, perception with organization's value, image) and recruiting factors (politeness, status, competency of recruiter).

At present in Bangladesh the fastest growing sectors are the financial, information technology and telecommunication where most business graduates are getting jobs and at the same time graduates also prefer these industries (Khaled Shams Chishty, Munir Uddin and Kumar Ghosh, 2007). Again, these business graduates consider their major academic orientation, gender, and personality to determine whether to join local organizations or MNCs (Huang & Sverke, 2007). Previous researches on the relationship between higher education and employment clearly demonstrated that the subjects graduates studied in the undergraduate level highly influence their career choices (Purcell, Elias and Davies, & Wilton, 2005). For the past few decades, many researchers have investigated various factors that influence job selection decisions. Several of them focused on preferences for certain categories of students such as accounting students (Bundy & Norris 1991, Rebele, Apostolou, Buckless, Hassel, Paquette & Stout, 1998, Rebele, Stout & Hassell 1991) and information systems students (Robbins 1996). Others have looked for differences between perceptions of students before and after a decision on a job offer (Turban, Eyring & Campion 1993), between students and recruiters (Butler et. al 2000, Kirsch, Leathers & Snead 1993), and between students and working professionals (Carcello, Copeland, Hermanson & Turner 1991).

Number of researchers have looked at various sets of factors important to individuals in evaluating jobs. Some have attempted to categorize these factors in various ways, including job and organization characteristics (Barber & Roehling, 1993; Feldman & Arnold, 1978); employment process categories (Barber & Roehling, 1993); work values (Judge & Bretz, 1992); motivation and hygiene factors (Misra & Karlo, 1972); factors intrinsic and extrinsic to the job (O'Reilly & Caldwell, 1980); existence, relatedness, growth factors (Shamir & Arthur, 1989); recruiter characteristics and evaluative issues (Rynes, 1900; Rynes, Heneman, & Schwab, 1980; Rynes & Miller, 1983). Importance and recognition of job, organizational attractiveness and diversity, characteristics of recruiter's greatly attract business graduates towards the organization and their preferred career (Thomas, 1999). On the basis of above analysis this study developed an integrated model for career preferences of Bangladeshi graduates which are shown in Fig-1.

3.3. A Conceptual Framework

Based on the literature reviews it has become an established fact that career preferences is quite influenced by the social status, living cost, family background, educational background, years of schooling, self-actualization, individual cognitive ability, emotional intelligence, personality, socio-economic background. Based on these factors a conceptual model has been developed to show the relationship among afore said variables and the career preferences. This model describes the relationships among various factors (internal factors like-cognitive ability, values, ethics, socio-economic, motivational, and employer's characteristics). This model also identifies the variables which may influence the various factors and thus giving a new dimension for graduates' career preferences in Bangladesh.

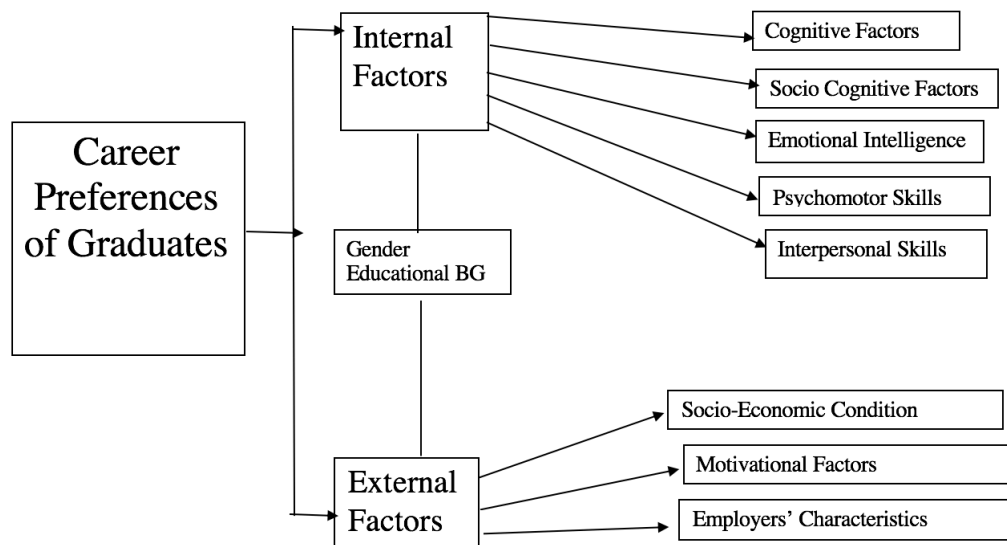

Fig: A Conceptual Framework of Career Preferences of Graduates in Bangladesh

5. Conclusion

Based on the substantial literature review it is visible that, age, gender, economic condition, family background, social status, emotional feelings, attitude of graduates, these variables have strong effect on career preferences of graduates worldwide. The developed conceptual framework also suggested that these variables also substantially influence the graduates of Bangladesh. The recruiters and both local, multinational private and public organizations can consider these variables while recruiting the graduates and thus make an effective recruitment decision.

References

- Agarwala, T., 2008. Factors influencing career choice of management students in India. *Career Development International*, 13(4), pp.362-376.
- Ahmed, K.A., Sharif, N. and Ahmad, N., 2017. Factors influencing students' career choices: empirical evidence from business students. *Journal of Southeast Asian Research*, pp.1-15.
- Ajzen, I., 1991. The theory of planned behavior. *Organizational behavior and human decision processes*, 50(2), pp.179-211.
- Amdurer, E., Boyatzis, R.E., Saatcioglu, A., Smith, M.L. and Taylor, S.N., 2014. Long term impact of emotional, social and cognitive intelligence competencies and GMAT on career and life satisfaction and career success. *Frontiers in Psychology*, 5, p.1447.
- Bandura, A., 1986. Social foundations of thought and action. *Englewood Cliffs, NJ*, 1986.
- Barber, A.E. and Roehling, M.V., 1993. Job postings and the decision to interview: A verbal protocol analysis. *Journal of Applied Psychology*, 78(5), p.845.
- Birley, S. and Westhead, P., 1994. A taxonomy of business start-up reasons and their impact on firm growth and size. *Journal of business venturing*, 9(1), pp.7-31.
- Brown, D., 2002. The role of work and cultural values in occupational choice, satisfaction, and success: A theoretical statement. *Journal of counseling & development*, 80(1), pp.48-56.
- Browne, B.A., 1997. Gender and preferences for job attributes: A cross cultural comparison. *Sex Roles*, 37(1-2), pp.61-71.
- Bundy, P. and Norris, D., 1992. What accounting students consider important in the job selection process. *Journal of Applied Business Research*, 8(2), pp.1-6.
- Carter, N.M., Gartner, W.B., Shaver, K.G. and Gatewood, E.J., 2003. The career reasons of nascent entrepreneurs. *Journal of Business Venturing*, 18(1), pp.13-39.

- Cable, D.M. and Judge, T.A., 1994. Pay preferences and job search decisions: A person-organization fit perspective. *Personnel psychology*, 47(2), pp.317-348.
- Carcello, J.V., Copeland Jr, J.E., Hermanson, R.H. and Turner, D.H., 1991. A public accounting career: The gap between student expectations and accounting staff experiences. *Accounting Horizons*, 5(3), p.1.
- Elias, P. and Purcell, K., 2004. Is mass higher education working? Evidence from the labour market experiences of recent graduates. *National Institute Economic Review*, 190(1), pp.60-74.
- Fallows, S. and Steven, C., 2000. Building employability skills into the higher education curriculum: a university-wide initiative. *Education+ training*, 42(2), pp.75-83.
- Ferry, N.M., 2006. Factors influencing career choices of adolescents and young adults in rural Pennsylvania. *Journal of Extension*, 44(3), pp.1-6.
- Geçikli, F., 2002. BİREYSEL KARIYER PLANLAMA VE GELİŞTİRMEDE İMAJIN ROLÜ. *İstanbul Üniversitesi İletişim Fakültesi Dergisi\ Istanbul University Faculty of Communication Journal*, (15).
- Herrnstein, R. J. & Murray, C.(1994) *The Bell curve: Intelligence and class structure in American life*. New York: The Free Press.
- Hossain, M.E. and Siddique, T., 2015. Career Preference of Business Graduate in Bangladesh: A Case Study of Some Selected Private Universities. *Asian Business Review*, 1(2), pp.106-113.
- Huang, Q. and Sverke, M., 2007. Women's occupational career patterns over 27 years: Relations to family of origin, life careers, and wellness. *Journal of vocational behavior*, 70(2), pp.369-397.
- Johnston, W.B., & Packer, A.H.(1987) *Workforce2000: Work and workers for the 21st century*. Indianapolis: Hudson Institute.
- Judge, T.A. and Bretz, R.D., 1992. Effects of work values on job choice decisions. *Journal of applied psychology*, 77(3), p.261.
- Ketter, P., 2011. Soft skills are must-haves in future workplace. *T&D*, 65(9), pp.10-10.
- K.K. Chisty, G. Munir Uddin & S.K. Ghosh (2007). The Business Graduates Employability in Bangladesh: Dilemma and Expected Skills by Corporate World. *Brac University Journal*, Vol.IV, No:1. PP:1-8.
- Kirsch, R.J., Leathers, P.E. and Snead, K.C., 1993. Student versus recruiter perceptions of the importance of staff auditor performance variables. *Accounting Horizons*, 7(4), p.58.
- Konrad, A.M., Ritchie Jr, J.E., Lieb, P. and Corrigan, E., 2000. Sex differences and similarities in job attribute preferences: a meta-analysis. *Psychological bulletin*, 126(4), p.593.
- Krumboltz, J. D., Mitchell, A. M. and Brian Jones, G. (1976) 'A Social Learning Theory of Career Selection', *The Counseling Psychologist*, 6(1), pp. 71–81. doi: 10.1177/001100007600600117.
- Misra, S. and Kalro, A., 1972. Simulated organizational choice: Post decision dissonance reduction and self-perception. *Journal of Applied Psychology*, 56(6), p.461.
- Morrison, A.M. and Von Glinow, M.A., 1990. *Women and minorities in management* (Vol. 45, No. 2, p. 200). American Psychological Association.
- M. Rahman.(1987) *Career Preferences and Employment profile Among Graduating and Graduate MBAs of IBA, Dhaka University*. *Journal of Business Administration*, Vol. 13, No.2, p-143.
- Moy, J.W. and Lee, S.M., 2002. The career choice of business graduates: SMEs or MNCs? *Career Development International*, 7(6), pp.339-347.
- Ngesi MJ 2003. *A Study Of Systematic Processes Influencing Educational Change in a Sample of IsiZulu Medium Schools*. Ph.D Thesis, Unpublished. Pietermaritzburg, University of Natal.
- O'reilly, C.A. and Caldwell, D.F., 1980. Job choice: The impact of intrinsic and extrinsic factors on subsequent satisfaction and commitment. *Journal of Applied Psychology*, 65(5), p.559.
- Rebele, J.E., Apostolou, B.A., Buckless, F.A., Hassell, J.M., Paquette, L.R. and Stout, D.E., 1998. Accounting education literature review (1991–1997), part II: students, educational technology, assessment and faculty issues1. *Journal of Accounting Education*, 16(2), pp.179-245.
- Redman, T.&Wilkinson, A., 2001.*Contemporary Human Resources Management*, NewYork: Financial Times , Prentice Hall.
- Robbins, R.R., 1996. Attitudes and Perceptions of Computer Information Systems students toward Employment Opportunities. *Journal of employment counseling*, 33(2), pp.61-69.
- Rynes, S.L., 1989. Recruitment, job choice, and post-hire consequences: A call for new research directions.
- Rynes, S.L., Schwab, D.P. and Heneman III, H.G., 1983. The role of pay and market pay variability in job application decisions. *Organizational Behavior and Human Performance*, 31(3), pp.353-364.
- Sax, L.J., 1994. Retaining tomorrow's scientists: Exploring the factors that keep male and female college students interested in science careers. *Journal of Women and Minorities in Science and Engineering*, 1(1).
- Saks, A.M. and Ashforth, B.E., 2002. Is job search related to employment quality? It all depends on the fit. *Journal of applied Psychology*, 87(4), p.646.
- Schwab, D.P., 1980. *Recruiting and organizational participation*. Graduate School of Business, University of Wisconsin-Madison.
- Shamir, B. and Arthur, M.B., 1989. An exploratory study of perceived career change and job attitudes among job changers. *Journal of Applied Social Psychology*, 19(9), pp.701-716.

- Thomas, K.M. and Wise, P.G., 1999. Organizational attractiveness and individual differences: Are diverse applicants attracted by different factors?. *Journal of Business and Psychology*, 13(3), pp.375-390.
- Tolbert, P.S. and Moen, P., 1998. Men's and women's definitions of "good" jobs: Similarities and differences by age and across time. *Work and occupations*, 25(2), pp.168-194.
- Turban, D.B., Eyring, A.R. and Campion, J.E., 1993. Job attributes: Preferences compared with reasons given for accepting and rejecting job offers. *Journal of Occupational and Organizational Psychology*, 66(1), pp.71-81.
- Van Auken, H., Stephens, P., Fry, F.L. and Silva, J., 2006. Role model influences on entrepreneurial intentions: A comparison between USA and Mexico. *The International Entrepreneurship and Management Journal*, 2(3), pp.325-336.



The Impact of Effective Training on Employee Retention: A Study in Private Banks of Bangladesh

Shahin Akther¹, Javed Tariq²

¹Faculty Member, Training Institute, Mercantile Bank Limited, Dhaka, Bangladesh, Email:shahustc@gmail.com

²Principal, Training Institute, Mercantile Bank Limited, Dhaka, Bangladesh
Email:javed.tariq@mblbd.com

Abstract

This examination underlines on the affectability of variables influencing employee continuation in Banking Industry of Bangladesh. Retain human resources is a procedure practiced by organizations to keep hold of a successful workforce and simultaneously meet operational necessities. Every organization must regard their work force as prime assets and need not to intend to depart since they enhance the value of the organization. The goal of the investigation is to gauge the view of employee retention. For this purpose, the sample chose 204 employees working in private banks of Bangladesh. We have utilized needed testing technique for credible information accumulation. We have utilized just essential information through an endorsed questionnaire. The gathered information was handled by applying t-test, ANOVA. In this investigation, univariate, bivariate and multivariate examinations were executed. Factor analysis and regression examination have attempted to evaluate the relationship of the factors. The aftereffect of the examination uncovers that employee retention relies upon depends on growth opportunity of the employees, employee self-attainment, Training and Development and employee benefits.

Keywords: Employee Retention, Regression, Factor Analysis, ANOVA, t-test

1. Introduction

Retention of employees is one of the biggest concerns for any organizations. Many renowned organizations are constantly struggling with the 'retention' issues nowadays. Today's ever-changing digitized business practices put many organizations to train its workforce constantly which incurs big spending. Therefore, business entities must retain their trained workforce in order to save money because quick turnover hits the bottom line of company's profit. Besides when an organization constantly trains new employees it is a waste of resources. Studies found that when you replace an employee it cost between 20-200% in terms of salary benefit. Consistency is essential for building a business. Losing trained workers slows down the business continuity. Besides, it becomes difficult to attract talents in a transient workforce. Less turn over enhances employee morale, initiates loyalty for the organizations. From marketing point of view retention improves productivity, builds brand image and keeps customer trust.

Bangladesh's banking sector faces some stumbling blocks in improving its service excellence due to poor show in employee retention. Rapidly changing modes of banking practices compel banks to train and retain their employees

for a much longer period of time. Longer working hours, shorter leave period due to work pressure, lesser leave benefits compare to other sectors poses a threat to retain employees in the banking sector. In order to sustain global competition banking sector of Bangladesh must give a serious look to find factors that causes employee turnover. The paper finds various reasons which effects poor employee retention. Factors like work-life-balance, leave duration, leave benefit are some of the mentionable reasons behind lesser than expected employee retention in banking sector of Bangladesh.

2. Literature Review

Extensive academic literatures can be found on the subject of retention of employees in banks & related organizations. The goal of this study is to investigate major variables mentioned in previous literatures.

At present there are 59 scheduled-banks¹ and 05 non-scheduled bank² in Bangladesh which are supervised and guided by country's central bank under Bangladesh Bank Order 1972 and Bank Company Act, 1991. There also operating 34 Non-Banking Financial Institutions (NBFI) regulated under Financial Institution Act 1993 of central bank. Given much importance to this sector due to its regulatory nature and specialize category employee retention plays a major and vital issue apart from other contingent problems such as scarcity of competent employment, employee turnover, motivation and training & development of employee.

Retention is defined as the capability to hold those employees that an organization wants to keep for a longer period (Johnson, 2000). Many findings on employee retention indicate that the absence of retention strategy is making it difficult for leadership to identify crucial skills that must be retained (Mohlala, Goldman and Goosen,2012). Employee retention is a key factor in an organization's success (Lyria, Namusonge and Karanja, 2017). Retention of skilled employees has been of serious concern to managers in the face of ever-increasing high rate of employee turnover. Employees are the most valuable resource in any organization for that matter; special treatment is required to retain them in order to help in achieving organizational performance strategies (Ritter, 2011).

Employees are less likely to leave when they share similar values as their organizations, HRM practices can be used strategically to improve the employee-organization value fit to improve retention (Presbitero, Roxas, and Chadee, 2016). The retention of employees can be further increased through job specific training, career development chances, friendly work environment and rewards with other benefits that should be planned by the organization (Setia and Singh,2014). According to Mwangi and Omondi (2016), creating an amicable and conducive working environment, makes the employees to work and stay in the organization. Work engagement and rewards (Karatepe ,2013), work-life balance (Mwangi and Omondi, 2016), promotion policy have a big role in increasing job satisfaction, which may secure employee retention in banking sector.

Banks are investing immensely in recruiting and developing their employees. The organization is completely at a loss when the employees leave their job once they are fully trained, developed and more so when they already have the experience of operations in the organization thus employee retention should take into account the various measures so that an individual stay in an organization for the maximum period of time (Sinha and Shukla, 2013). HR managers try to prevent the employee turnover by implementing effective retention strategies (James and Mathew, 2012). An integrated HR strategy combining resource and control-based HR practices could also improve retention (Davidson, 2010). These variables consist of training/learning, career development, reward, recognition, attractive salary deal, and job security. Nevertheless, the magnitude of other variables should not be less valued when making plan for retention policy. The levers of retention being used by them are: special training programs, talent pool programs, on boarding of new recruits, job rotation, comfortable postings, incentives, and fast-track promotions. Whereas Carl, Bjorkman, &Pavlovskaya, (1999) highlighted that now the HRM practice to focus an individual is the proactive approach by the management and also became a competitive advantage for the business

¹Schedule Banks are referred to those banks that remain in the list of banks maintained under the Bangladesh Bank Order, 1972.

²Non Scheduled banks which are established for special and definite objectives and operate under any act but are not Scheduled Banks. These banks cannot perform all functions of scheduled banks.

in the last decade. Newly researches find out the relationship of HRM practices with organizational performance, organizational strategies and organizational retention, which are the three different aspects.

In Bangladesh, some determinants of bank employees' retention have been identified such as unattractive pay packages, lack of training and development, partiality and lack of career development, long working hours, lack of job security (Tanchi, 2015).

Banks in Bangladesh are now aware of the bottom-line effect on retaining the quality of employees and central bank (Bangladesh Bank) puts its emphasis on employee retention policy through training. Banks should mold their policies in accordance to employee training and development, which will help banking sector to retain employees for longer time (Salman, Ahmad and Matin, 2014).

When the employees find job satisfaction, they hardly think of switching present job. Retaining skilled employee quite simply adds to increase productivity and morale, while dropping the associated and related costs of turnover. Employee retention is major vital issue facing corporate leaders as a consequence of the lack of skilled labor, economic growth and employee turnover (Ahmad, Iqbal and Sheeraz 2012). Sandhya, and Kumar (2011) suggested that employee retention can be practiced motivating the employees terms of 'Open Communication' that their opinions matter and that management is 100% interested in their input. Yamamoto (2011) emphasized employee benefits management as a sub-system in human resource management, contributing to employee retention. A number of articles focused on various determinants of employee in various financial and non-financial organizations and service industries such as training, compensation and appraisal (Hong, Hao, Kumar, Ramendran and Kadiresan, 2012), work environment (Duffield, Roche, Blay and Stasa, 2011).

According to Mike (2013), Succession planning should be encouraged in organisation. Role of employees should be cleared. Organization should invest in cross-training, coaching job shadowing, mentoring, and job rotation for employee retention.

3. Research Methodology

3.1 Research Design

The research design is a strategy where we integrate the various tools of the study in a scientific, logical and comprehensive way. Therefore, it constitutes the main script for the collection, management, measurement, and analysis of data (De Vaus, D. A, 2001).

In this study, we tried to investigate the cause and effect relationship between the possible retention influencing factors and employee retention, so it can be referred as causal study as well as quantitative research, because the methods of this study emphasize the statistical, mathematical and numerical analysis of data collected through questionnaires, using computational techniques (Babbie, Earl R, 2010). In addition, as some qualitative phenomenon is adopted in this research, it may be considered as mixed approach. To conduct this research, the cross-sectional method was implemented which implies that data was collected at a single moment in time by the several segments of population that are being sampled (Zikmund et al., 2013).

3.2 Population and Sampling Design

3.2.1 Population

A population is the total aggregation of components from which we collect a sample in order to analysis and make an inference of that total aggregation (Cooper & Schindler, 2014). In this study, the employees of the schedule banks, operated within the geographical area of Bangladesh, are our target population. In Bangladesh, total 59 banks are operating and according to the ownership those are categorized as- (a) State Owned Commercial Banks (6), (b) Islami Shariah based Bank (8) (c) Specialized Banks (3), (d) Private Commercial Banks (33) and (e) Foreign Commercial Banks (9). Since all these banks have their headquarters in one geographical location which

is capital city Dhaka, we decided to collect samples only from Dhaka District by covering as much as the number of banks in a short time.

3.2.2 Sampling Design

3.2.2.1 Sampling Frame

The sampling frame describes a set of components from which we can select a sample of the target population (Michael S, 2004). The rules and procedures by which some elements or components of the population are selected as samples or respondents are referred to the sampling method. In this study, our sampling frame is the complete list of total of 41 banks.

3.2.2.2 Sampling Technique

A sample is a smaller representative group collected from predefined population (Mugenda & Mugenda, 2003), whereas, sampling is the process or technique of selecting a number of individuals or objects from a population such that the selected group represent the maximum characteristics of the entire population (Orodho & Kombo, 2002). In this survey, we have used three stage sampling technique. In first stage we have adopted stratified random sampling technique with proportional allocation, in accordance we have divided the total 57 banks into four several mutually exclusive sub populations or strata according to the ownership of the bank. Secondly, we have used convenient sampling method to choose the bank from each state. In this second stage, we have selected the branches of the banks. In third stage, we have again used the convenient sampling technique to select the employee of the bank as our desired respondent. Convenience sampling is a sampling procedure in which most conveniently available respondents or units are obtained (Zikmund et al., 2013).

3.2.3 Sample Size

A sample size is a representative part of the population chosen for a survey or experiment (Bartlett, J. et al., 2001). We select sample size carefully so that it will be adequate to draw valid and generalized conclusions. We have fixed our sample size with considering that it fulfills the requirement of specific information regarding the problems under investigation in the population under study. (Singh, Ajay S, 2014). In this study, total population is the employees of 41 banks of our country. From these 59 banks we have excluded 6 state-owned commercial banks, 9 foreign commercial banks and 3 specialized banks because the strategies of these banks are different and there are no impact on employee retention in government-services. So, our final population is 41 banks. In any study, 30% sample is suitable to generalize the findings regarding the total population (Mugenda and Mugenda, 2003). In accordance, our study sampled 30% of the population (i.e. approximately 10 banks) proportionately from 41 banks based on their ownership.

The size (n) of sample is determined by following most widely used statistical equation considering that the sample would be 95% likely to measure an estimate with a given level of precision:

$$n = \frac{p(1-p)}{d^2} \times Z^2_{\alpha/2} \times deff$$

The value of the standard normal variate indicates that there is a 100 α % probability of selecting a bad sample. Here,

N= The size of the target population.

P=An a priori proportion.

Z $\alpha/2$ = Z value for α level of significance.

d=The allowable margin of error.

deff= Design effect used for complex survey.

N=Sample size.

The main concern of sample size determination is to make choice of P and d because different range of variable is in under study. We've considered here P=.5 since theoretically this gives the safest sample size as P(1-P) gives the highest value for P=.5. For this sample it is chosen that the value of allowable margin of error, d=.07. Conventionally deff can be taken as 1.5-2.0 in most surveys in Bangladesh which use complex sample such as

multi stage cluster sampling. Because of using stratified sampling instead of multistage sampling it is unnecessary to use large value of deff. So $deff=1$ is chosen here. The conventional choice of α is .05 is considered here which gives $Z_{\alpha/2}=1.96$. Considering all the above, we've got the total sample size, $n=196 \sim 200$. Finally, we collected 204 samples for our study.

Sample size is shown in the following table:

Sl. No.	Bank Name	Sample Size
1	Prime Bank Limited	20
2	Mercantile Bank Limited	24
3	First Security Islami Bank	20
4	Bank Asia Limited	20
5	Pubali Bank Limited	20
6	Uttara Bank Limited	20
7	Mutual Trust Bank Limited	20
8	Al-Arafa Islami Bank Limited	20
9	Premier Bank Limited	20
10	Padma Bank Limited	20
Total		204

3.3 Research Questionnaire

In our study, we used only primary data. To collect data/information we used a prescribed questionnaire as a data collection tool. Our questionnaire has prepared with two main segments consisting with 62 questions as (1) demographic and socio-economic variables and (2) Likert scale rating. Gender, Age Group, Marital Status, Education level, Designation/Position, Working Experience in this Bank, Total Working Experience and Job Category are the demographic and socio-economic variables.

3.4 Conceptual Framework

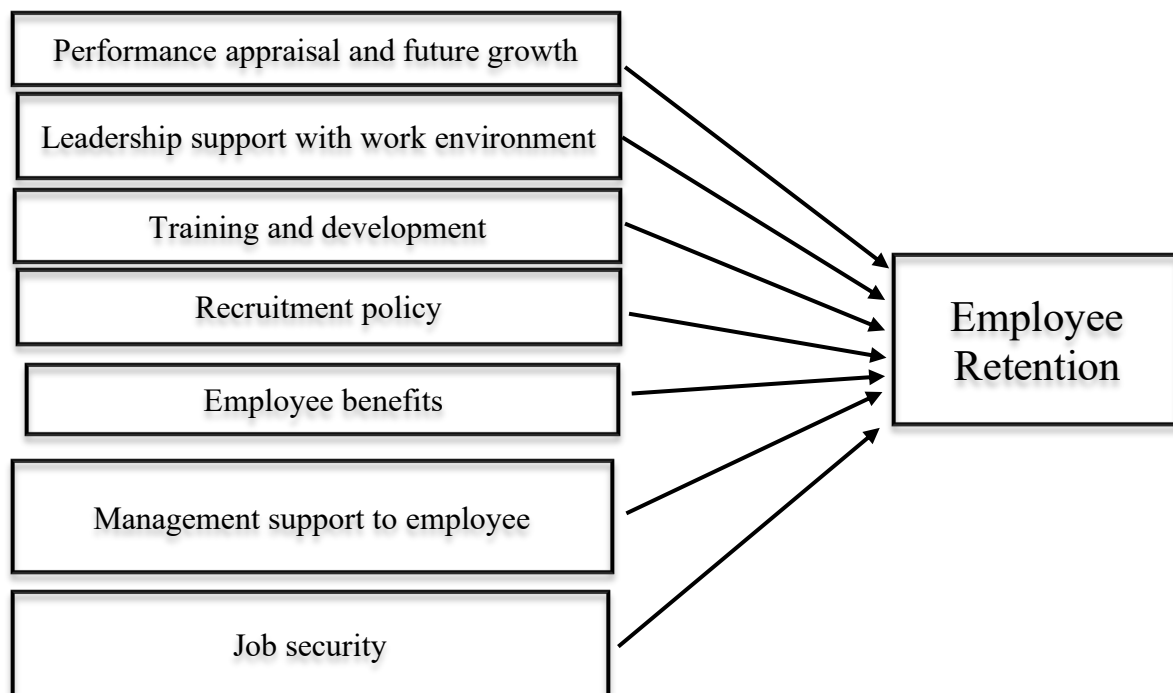

The above conceptual framework explains that employees' retention is being used as dependent variable whereas seven independent variables such as Performance appraisal and future growth, Leadership support with work

environment, Training and development, Recruitment policy, Employee benefits, Management support to employee and Job security are also being used in this research to investigate the relationship among them.

3.5 Data Collection

Data collection is the process of collecting and measuring information on variables of interest, in a recognized systematic way that enables one to answer specified research questions, and evaluate the outcomes (Cooper and Schindler, 2008). Our primary data collection method has carried out by the use of questionnaires. Questionnaires were considered a good data collection tool as they allow the researcher to collect information from a large target population within a short time period and can be done with cost-effective way (Creswell, 2013). After selecting the banks through stratified random sampling, we selected the employees with convenience sampling method. Finally, we collected data through a predesigned questionnaire by face-to-face interview. To ensure a maximum response rate, respondents was informed earlier of the time of interview and tried to make it easier for them to promise to the interview without feeling pressured.

3.6 Research Procedures

Before the administration of the questionnaire we have pre-tested to ensure reliability, relevancy and validity of the information to be collected. This pretested data has collected from a small sample only forty employees working in the banks. The main purpose of pre-testing the questionnaire is to identify the irrelevant, biased, confusing and sensitive statement in the data collection instrument and try to omit or modify them. Pre-testing permits modification before the final test (Cooper & Schindler, 2003). After pre-testing the questionnaire, we have finalized the questionnaire and collected our desire number of data for final analysis.

3.7 Data Analysis Methods

Data Analysis is a process in which data sets are analyzed, inspected and fitted to the model with the goal of discovering useful information (Elite Crest Technology, 2019). In this study, we have performed univariate, bivariate and multivariate analysis. In univariate analysis, we have displayed the variables' information with percentages and counts in a tabular/graphical form. Moreover, for bivariate analysis we performed cross-tabulation and chi-square test to investigate relationship between variables and the result have represented in a tabular form with percentage. We also performed correlation analysis to establish the relationship between the dependent variable and the independent variables. Finally, we have analyzed the data in a multivariate way. In this way we performed factor analysis and multiple regression analysis to quantify the relationship and find out the strength of dependency of dependent variable on independent variables. The empirical model is specified as:

$$\begin{aligned}
 \text{Employee Retention} = & \alpha + \beta_1 \text{Performance appraisal and future growth} \\
 & + \beta_2 \text{Leadership support with work environment} \\
 & + \beta_3 \text{Training and development} \\
 & + \beta_4 \text{Recruitment policy} \\
 & + \beta_5 \text{Employee benefits} \\
 & + \beta_6 \text{Management support to employee} \\
 & + \beta_7 \text{Job Security} + e_i
 \end{aligned}$$

4. Data Analysis & Findings

4.1 Introduction

This study is intended to assess the satisfaction of the employees of banking industry operated in Bangladesh. Consequently, data of 204 employees, those are continuing their job in different banks, was collected through structured questionnaire as a survey tool. In this section we presented the data analysis and key findings based on the various data analyses. The first part entailed Descriptive Analysis to formulate the summary of respondents' background information. Second, it involved the explanatory measurement assessment for different attributes

related to employee retention by running Factor Analysis & Reliability Analysis to conform that the constructs used in the survey tool are relevant and valid. Finally, we dealt with bivariate analysis to verify if there was any association among the dependent variable and independent variables by conducting Correlation Analysis. In addition, it demonstrated the strength and direction of relationships between independent and dependent variables by Regression Analysis.

However, before the tests were carried out it was ensured that no missing values or irrelevant values existed in the data entry, which involved Data Cleaning process. The following sub-sections with detailed statistical tests used an alpha level of 0.05 and SPSS Version 25 was used for the data analyses.

4.2 Demographic and Social Profile (Univariate Analysis)

Descriptive statistical analysis was used to identify frequencies and percentages to interpret the background information of the participants in the survey.

Table 4.1 Frequency Distribution of the Respondents' Demographic and Social Status

Variables	Category	Frequency	Percent
Gender	Male	148	72.5
	Female	56	27.5
Age Group	18 – 25	15	7.4
	26 – 33	113	55.4
	34 – 41	54	26.5
	42 and above	22	10.8
Marital Status	Married	157	77.0
	Unmarried	47	23.0
Educational level	Master's Degree	183	89.7
	Others	21	10.3
Designation	Entry-EO	134	65.7
	SEO-FAVP	53	26.0
	Above FVP	17	8.3
Working experience in this organization	1 – 5 yrs	89	43.6
	5 – 10 yrs	82	40.2
	10 yrs and above	33	16.2
Total working experience	1 – 5 yrs	81	39.7
	5 – 10 yrs	77	37.7
	10 yrs and above	46	22.5
Job category	Permanent	195	95.6
	Others	9	4.4

Table 4.1 presented the information of the respondents' personal background. The respondents' demographic characteristics consisted of three items, which included the participants' gender, age group and marital status. The respondents' social status consisted of five items, which included the educational level, designation, working experience in this organization, total working experience and Job category. As stated in the table, the majority of respondents were male, 72.5% and 27.5% were female. The survey-illustrated more than half of the respondents, 55.4%, were aged between 26 to 33 years, followed by the age group of 34 to 41, (26.5%) and 10.8% respondents aged 42 years or above. The sampling population was 77.0% married. However, about 95.6% of respondents are employed as a permanent employee. Most of the respondents, (89.7%) completed Master Degree. With regards to working experience in present organization, 43.6% of the respondents worked for 1-5 years, followed by 40.2% whose working experience was 5-10 years. More than 10 years experienced employees were 16.2%. In case of designation, more than half portion (65.7%) of the respondents were entry to Executive Officer level and exactly 26% of the respondents were Senior Executive Officer to First Assistant Vice Principal.

4.3 Bivariate Analysis

Simultaneous analysis of two variables (attributes) is known as bivariate analysis. It indicates the concept of association between two variables, whether there exist any relationship and the strength of this association. Also, it measures whether there are differences between two variables and the significance of these differences.

Table 4.2 Measuring the Significant Difference among the Demographic variables for Employee Retention Score

Gender		N (%)	Mean ± SD	P-Value
Male	t-test	148 (72.5)	3.59 ± 0.66	0.056
Female		56 (27.5)	3.42 ± 0.55	
Age group		N (%)	Mean ± SD	P-Value
18 – 25	F-test	15 (7.4)	3.33 ± 0.46	0.393
26 – 33		113 (55.4)	3.53 ± 0.68	
34 – 41		54 (26.5)	3.64 ± 0.59	
42 and above		22 (10.8)	3.53 ± 0.58	
Marital Status		N (%)	Mean ± SD	P-Value
Married	t-test	157 (77.0)	3.54 ± 0.63	0.766
Unmarried		47 (23.0)	3.57 ± 0.65	
Education level		N (%)	Mean ± SD	P-Value
Master's Degree	t-test	183 (89.7)	3.58 ± 0.62	0.033
Others		21 (10.3)	3.23 ± 0.68	
Designation		N (%)	Mean ± SD	P-Value
Entry-EO	F-test	134 (65.7)	3.60 ± 0.65	0.190
SEO-FAVP		53 (26.0)	3.41 ± 0.63	
Above FVP		17 (8.3)	3.52 ± 0.51	
Working experience in this organization		N (%)	Mean ± SD	P-Value
1 – 5 yrs	F-test	89 (43.6)	3.57 ± 0.62	0.904
5 – 10 yrs		82 (40.2)	3.53 ± 0.68	
10 yrs and above		33 (16.2)	3.51 ± 0.55	
Job Category		N (%)	Mean ± SD	P-Value
Permanent	t-test	195 (95.6)	3.55 ± 0.64	0.611
Others		9 (4.4)	3.44 ± 0.61	

Table 4.2 revealed that all are insignificant except 'Education Level' this means that there is no significant difference within the group to retain the organization or not. Since most of the variables are insignificant we cannot consider these for further analyses.

Table 4.3 Correlation between Dependent and Independent Variables.

		Employee Retention
Employee Retention	Pearson Correlation	1
	Sig. (2-tailed)	
Performance appraisal and future growth	Pearson Correlation	.478**
	Sig. (2-tailed)	.000
Leadership support with work environment	Pearson Correlation	.387**
	Sig. (2-tailed)	.000
Training and development	Pearson Correlation	.477**
	Sig. (2-tailed)	.000
Recruitment policy	Pearson Correlation	.233**
	Sig. (2-tailed)	.001
Employee benefits	Pearson Correlation	.445**
	Sig. (2-tailed)	.000
Management support to employee	Pearson Correlation	.267**
	Sig. (2-tailed)	.000
Job security	Pearson Correlation	.200**

	Sig. (2-tailed)	.004
--	-----------------	------

***. Correlation is significant at the 0.01 level (2-tailed).*

From the above table we observed that all variables are inter correlated between them with highly significant. The correlation between dependent variable (Employee Retention) and independent variables is significant at 1% level of significance.

4.4 Multivariate Analysis

4.4.1 Factor Analysis

Factor analysis is a dimension reduction technique that is used to reduce a large number of attributes to a smaller set of components. Factor analysis is used in data reduction as the analysis can group similar cases, however, it cannot distinguish between the dependent variable and independent variables (Yong & Pearce, 2013). It is used to measure constructs as well as to retain variables in a more manageable component.

The Factor Eigenvalues measured how much of the variance of the observed variables explained a factor. Factor Eigenvalues must be greater than or equal to 1 to be significant (Yong & Pearce, 2013). In this study, Principal Components Varimax Rotated Method has been used to identify the factors influencing of employee retention in banking industry of Bangladesh. Factor loading with a value of 1.5 and above are retained as they are pure measure of the constructs.

The Kaiser-Meyer-Olkin (KMO) measured how suited is the data collected for Factor Analysis. KMO value would range from 0 to 1. In addition, if the value lies between 0.8 to 1, it would indicate that the sampling is adequate, whereas if the value is less than 0.6 it would mean that the sampling is not adequate (Yong & Pearce, 2013). In our study KMO = 0.848, that indicates our samplings is adequate. Bartlett's Test of Sphericity determined the validity and suitability of the responses collected to the problem being addressed or not. In order for the factorability to be significant, the Bartlett's Test of Sphericity should be significant at ($p < 0.05$). If the significance level is lower than the recommended value of $p < 0.05$, it would indicate Factor Analysis is appropriate (Yong & Pearce, 2013). Our Bartlett's Test of Sphericity is highly significant ($p < 0.001$)

Table 4.4 KMO and Bartlett's Test

Kaiser-Meyer-Olkin Measure of Sampling Adequacy.		.848
Bartlett's Test of Sphericity	Approx. Chi-Square	3775.595
	df	990
	Sig.	.000

Table 4.5 Factors with Explained Variation

Factors	Eigen Value and Explained Variance		
	Eigen Value	% of Variance	Cumulative %
Factor 1: Performance Appraisal and Future Growth	10.575	23.499	23.499
Factor 2: Leadership Support with Work Environment	2.686	5.969	29.468
Factor 3: Training and Development	2.672	5.937	35.405
Factor 4: Recruitment Policy	2.103	4.674	40.079
Factor 5: Employee Benefits	1.890	4.200	44.279
Factor 6: Management Support to Employee	1.642	3.649	47.928
Factor 7: Job Security	1.533	3.406	51.334

After observing the KMO and Bartlett's test, to maximize the variance of each of the factors the "varimax" rotation was executed that will reallocate the accounted variance among the extracted factors. 23.499% of employee retention can be explained by first factor and the second extracted factor explained about 5.969% of variation of

employee retention. The succeeding five extracted factors are accountable for 5.937, 4.674, 4.200, 3.649 and 3.406% of employee retention respectively.

The "Screen plot" is also an important tool to identify the number of factors to be accepted. From the following scree plot we observed that after the first seven factors the Eigen values are more stable, it is suggested that extracting seven factors might be a sensible choice for the employee retention data.

Figure 4.1 Scree Plot for Eigenvalues

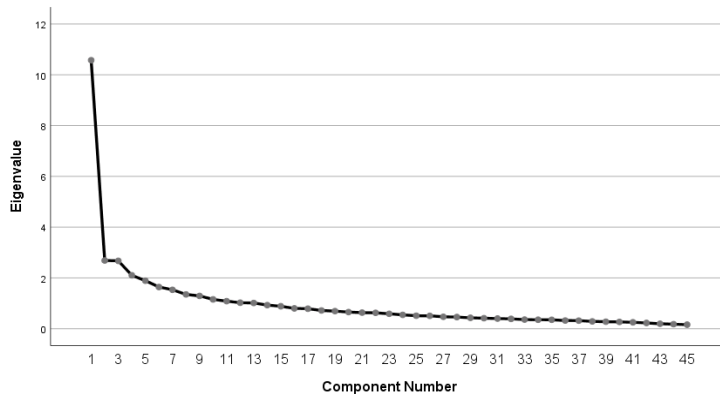

Table 4.6 Rotated Component Matrix

	Component						
	1	2	3	4	5	6	7
My Bank selects right person at right place at right time	.669						
Performance is measured with unbiasedness in my Bank	.654						
In this Bank, there is no nepotism in the selection	.647						
Performance is measured with the weight of work	.605						
It has good and transparent reward practice policy	.556						
In this Bank we have self-actualization opportunity	.514						
Performance is measured throughout the year							
It has a standard policy to measure the performance							
It provides an adequate insurance coverage plan							
Line manager shares information willingly							
Enjoyable working condition in my Bank		.680					
Always I get appreciation of my decent work		.677					
I get recognition for each work from my manager		.661					
I have freedom in my work		.621					
My manager guides me in my future career		.548					
Work is monitored by manager effectively		.542					
This Bank assigns to me a work with sufficient time & according to capacity		.542					
My assignment is clearly defined by my manager							
Working time is eight (8) hours, no need to work more/extra time							
This Bank allocates an adequate funds for training purpose			.762				
Trainings obtained from my Bank makes me competent for higher position			.725				
This Bank facilitates the clear career paths			.604				
Our training instructors are very knowledgeable			.588				
This Bank arrange contemporary training frequently			.532				
This Bank follows a standard policy to recruit employees				.626			
My colleagues are supportive and friendly				.598			

This Bank recruits from both internal and external				.594			
On time salaries and bonuses payment				.539			
My manager has good relationship with top management							
Medical allowance is sufficient to me and my family				.646			
Leave plan of my Bank is satisfactory to me				.604			
TA/DA policy is sufficient to me				.589			
Retirement benefits are very lucrative of my Bank				.581			
Hansom bonuses are provided to me							
My Bank provides sufficient compensation to me							
There is no obligation to perform my assigned work							
There are entertainment facilities e.g. sports, PIKNIK					.582		
Salary structure is standard compared to other Banks					.567		
There is a good opportunity to get experience from diversified work					.554		
This Bank assigns the challenging work							
I want to take more challenging work than my existing work							
There is no involuntary termination policy/practice without great offence							.739
In this Bank, no one has influencing power to make an involuntary termination							.730
This Bank gives sufficient time to the employee in involuntary termination							.703
The distance of my work place from my house is amenable							
Extraction Method: Principal Component Analysis. Rotation Method: Varimax with Kaiser Normalization.							

Eigenvalues, Extracted Components, and Rotated Components. It measured how strong the constructs were and how many items which assessed employee retention is included in the model. According to the analysis, there are three components in the model with Eigenvalues more than 1.5, which was subsequently retained. In this case, the factors are made by the function of observed items by removing the clutter of low correlations or low inter item relationship (those are less than 0.50) that may insignificant. These 7 factors are specified below along with their components which are found from the rotated component matrix table:

Factor 1 can be entitled to “Performance Appraisal and Future Growth” because this factor contains of high coefficients for ‘My Bank selects right person at right place at right time’ (.669), ‘Performance is measured with unbiasedness in my Bank’ (.654), ‘In this Bank, there is no nepotism in the selection’ (.647), ‘Performance is measured with the weight of work’ (.605), ‘It has good and transparent reward practice policy’ (.556) and ‘In this Bank we have self-actualization opportunity’ (.514).

Factor 2 entitled as “Leadership Support with Work Environment” this factor contains of maximum coefficients for ‘Enjoyable working condition in my Bank’ (.680), ‘Always I get appreciation of my decent work’ (.677), ‘I get recognition for each work from my manager’ (.661), ‘I have freedom in my work’ (.621), ‘My manager guides me in my future career’ (.548), ‘Work is monitored by manager effectively’ (.542) and ‘This Bank assigns to me a work with sufficient time & according to capacity’ (.542).

Factor 3 we considered as “Training and Development” this factor covers the high coefficients for ‘This Bank allocates an adequate fund for training purpose’ (.762), ‘Trainings obtained from my Bank makes me competent for higher position’ (.725), ‘This Bank facilitates the clear career paths’ (.604), ‘Our training instructors are very knowledgeable’ (.588) and ‘This Bank arrange contemporary training frequently’ (.532).

Factor 4 can be expressed as “Recruitment Policy” this factor comprises the high coefficients for ‘This Bank follows a standard policy to recruit employees’ (.626), ‘My colleagues are supportive and friendly’ (.598), ‘This Bank recruits from both internal and external’ (.594) and ‘On time salaries and bonuses payment’ (.539).

Factor 5 can be entitled to “Employee Benefits” because this factor contains of high coefficients for ‘Medical allowance is sufficient to me and my family’ (.646), ‘Leave plan of my Bank is satisfactory to me’ (.604), ‘TA/DA policy is sufficient to me’ (.589) and ‘Retirement benefits are very lucrative of my Bank’ (.581).

Factor 6 entitled as “Management Support to Employee” this factor contains of maximum coefficients for ‘There are entertainment facilities e.g. sports, PIKNIK’ (.582), ‘Salary structure is standard compared to other Banks’ (.567) and ‘There is a good opportunity to get experience from diversified work’ (.554).

Factor 7 we considered as “Job Security” this factor covers the high coefficients for ‘There is no involuntary termination policy/practice without great offence’ (.739), ‘In this Bank, no one has influencing power to make an involuntary termination’ (.730) and ‘This Bank gives sufficient time to the employee in involuntary termination’ (.703).

4.4.2 Reliability Test

Reliability test is the most commonly used measure to check internal consistency of the items in an instrument of a research. Cronbach’s alpha is widely used and is regarded as a popular test that confirmed the reliability of each measure (Tavakol&Dennick, 2011). In accessing the data from the seven variables summed to determine the job satisfaction factors scores formed a reliable scale. Thus, the reliability test using the Cronbach Alpha values was conducted prior to further analysis. The alpha values for the “Performance appraisal and future growth” (0.707), “Leadership support with work environment” (0.717), “Training and development” (0.714), “Recruitment policy” (0.756), “Employee benefits” (0.730), “Management support to employee” (0.718) and “Job security” (0.768) indicated that the items formed a scale of reasonable internal consistencies in its reliability. The highest correlation for each item with at least one item in the constructs was between the value of 0.154 and 0.534. Therefore, all of the items correlate adequately in the constructs.

Table 4.7 Reliability Analysis

Factors	Reliability Analysis	
	Number of Items	Cronbach Alpha Value
Factor 1: Performance appraisal and future growth	6	0.707
Factor 2: Leadership support with work environment	7	0.717
Factor 3: Training and development	5	0.714
Factor 4: Recruitment policy	4	0.756
Factor 5: Employee benefits	3	0.730
Factor 6: Management support to employee	4	0.718
Factor 7: Job security	3	0.768

4.4.3 Regression Analysis

4.4.3.1 Assumption Test for Regression Analysis

Linear regression is an analysis that measures whether one or more explanatory variables predict the dependent variable. The regression has some key assumptions such as Linear relationship, Multivariate normality, no or little multicollinearity, no auto-correlation & Homoscedasticity and no outliers in dataset.

4.4.3.1.1 Tests on Linearity

Figure 4.2 Scatter Plot for Linearity Test

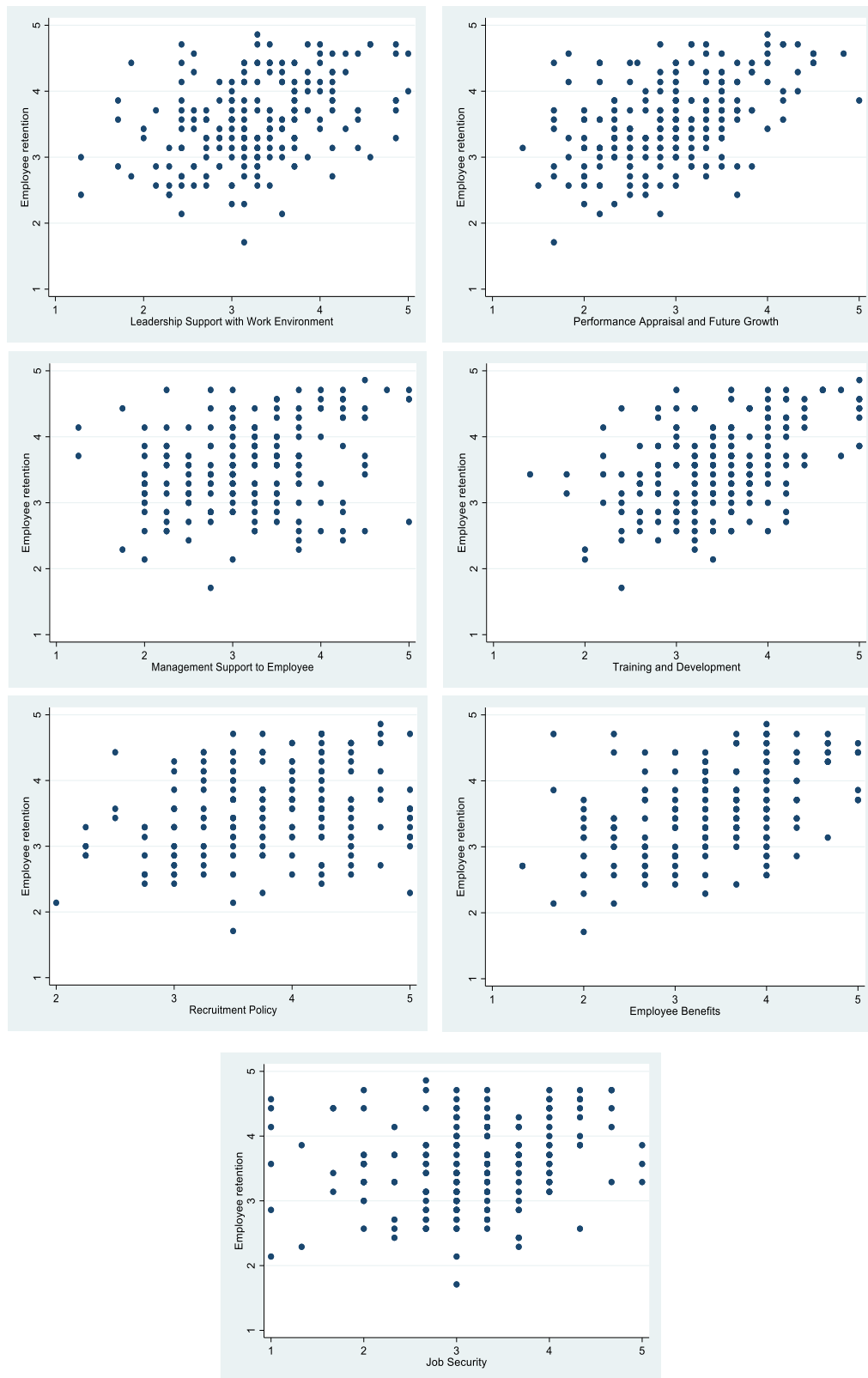

The above scatter plots represent the scatter plots of all possible independent variables with dependent variable (Employee retention). The plots illustrate that all independent variables are more or less linearly related with dependent variable

4.4.3.1.2 Tests on Normality of dependent variable

Figure 4.3 Histogram for Normality Test

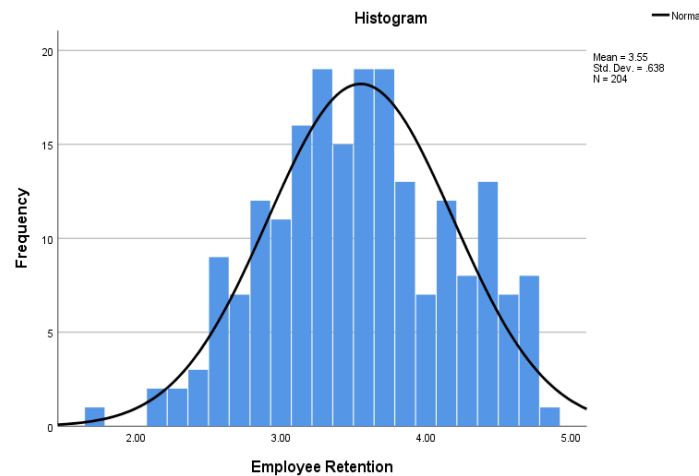

From the 4.3 figure we observed that the distribution of dependent variable is normal. This normally distributed dependent variable met our regression assumption.

The values of the residuals are independent

Table 4.8 Durbin Watson Test

	R	R square	Adjusted R square.	SE	Durbin Watson
Multiple regression model	0.60	0.36	0.34	0.51	1.92

This assumption is basically same as saying that we need our observations to be independent (or uncorrelated). This can be tested by Durbin-Watson test. This statistic can vary 0 to 4. It can be said that the values of the residuals are independent if the Durbin Watson statistic is close to 2. Values below 1 and above 3 are cause of concern. In this case the value is 1.92, so this assumption has been met.

4.4.3.1.3 Tests on Multicollinearity

Table 4.9 Variance Inflation Factor

Independent Variables	Collinearity Statistics	
	Tolerance	VIF
(Constant)		
Performance appraisal and future growth	0.562	1.780
Leadership support with work environment	0.648	1.542
Training and development	0.601	1.665
Recruitment policy	0.856	1.168
Employee benefits	0.725	1.380
Management support to employee	0.705	1.418
Job security	0.879	1.138

Here we checked the absence of multicollinearity using VIF values. All the way at the right end of the table, we found the VIF values. As stated by O'Brien 'commonly a VIF of 10 or even one as low as 4 have been used as rules of thumb to indicate excessive or serious collinearity'. By considering these rules of thumb, each value is below 10(O'Brien, 2007), indicating that the assumption is met.

4.4.3.1.4 Tests on Nonlinearity and Homogeneity of Variance

Figure 4.4 Scatter Plot for Homogeneity Test

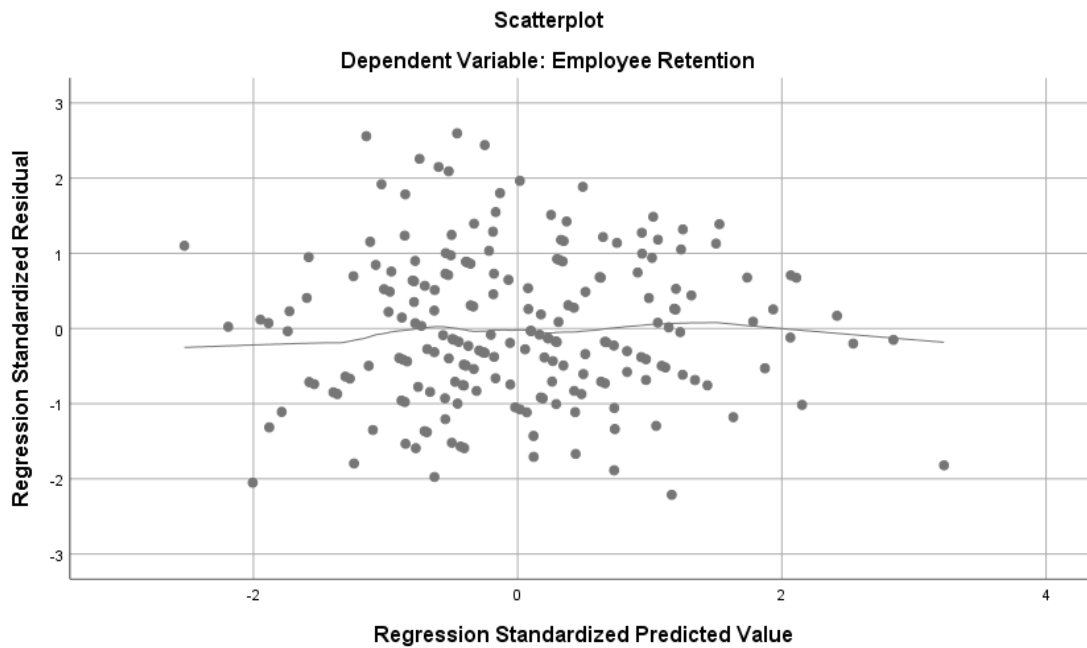

It appears that the relationship of standardized predicted to residuals is roughly linear around zero. We can conclude that the relationship between the response variable and predictors is zero since the residuals seem to be randomly scattered around zero.

4.4.3.1.5 Test on Normality for Residuals

Figure 4.5 Normal P-P plot for regression standardized Residuals

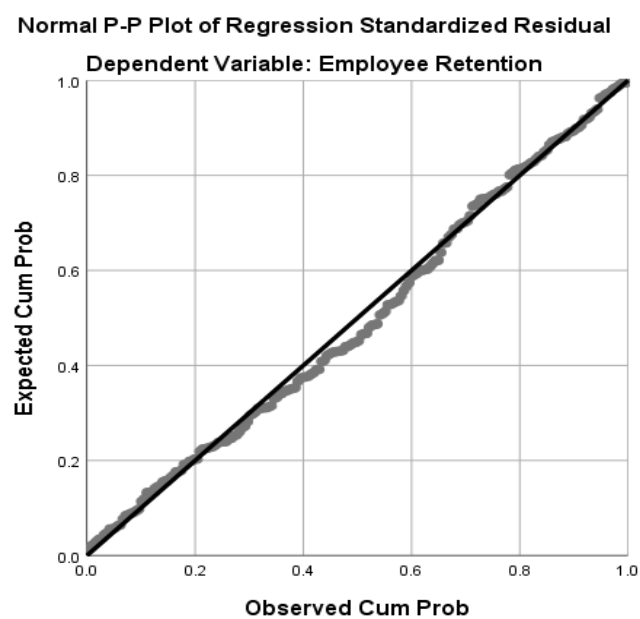

This assumption can be tested by looking at the P-P plot for the model. The closer the dots lie to the straight line the closer the residuals are normally distributed. In this case our data points mostly touch the straight line or are close to the line. So, it can be said that this assumption has been met.

4.4.3.1.6 Test for identifying the outliers.

The final assumption can be checked by going to the data set and looking the cook's distance. Any value above 1 are likely to be significant outliers, which may influence the model. In this case no such instances have occurred our maximum value is 0.07551. So, there are no influential cases biasing our model.

4.4.3.2 Simple Regression

In simple regression, there is one dependent variable and one independent variable. This is performed to quantify the dependency of dependent variable on explanatory variable (Neter J. et al., 1990).

Table 4.10 Simple Linear Regression

Influencing Factors	Unstandardized Coefficients		t	Sig.
	B	Std. Error		
Performance appraisal and future growth	0.424	0.055	7.730	0.000
Leadership support with work environment	0.343	0.058	5.957	0.000
Training and development	0.440	0.057	7.723	0.000
Recruitment policy	0.220	0.065	3.405	0.001
Employee benefits	0.358	0.051	7.062	0.000
Management support to employee	0.227	0.058	3.938	0.000
Management support to employee	0.227	0.058	3.938	0.000

***Dependent Variable: Employee Retention**

From the above table, it is revealed that if we perform simple regression by taking these seven independent variables individually all are shown the significant impact on employee retention. 'Training and development' shown the highest impact ($B=0.440$, $p<0.001$) on employee retention and minimum impact ($B=0.220$, $P=0.001$) found for the variable 'recruitment policy'.

4.4.3.3 Multiple Regression

Regression Analysis is sometimes used to build model for the relationship between dependent variables and one or more independent variables (Ramlan & Adnan, 2016). For this study Multiple Linear Regression has been chosen to estimate the relationship between a response variable and seven independent variables.

Multiple Linear Regression is an extension of Simple Linear Regression. It is used to predict the value of one dependent variable based on two or more explanatory variables (Kumar, 2014). In this study, considering employee retention as a dependent variable and tangible products, personnel service quality, level of commitment and level of compassion as independent variables Multiple Linear Regression has been performed here.

Table 4.11 Model Summary for Multiple Regression

R	R Square	Adjusted R Square	Std. Error of the Estimate
0.606	0.367	0.344	0.51679

R, the multiple correlation coefficient is the measure of the prediction of the dependent variable based on independent variables (Ramlan & Adnan, 2016). The value $R=0.606$, indicated that the level of prediction to assess employee retention was good, (Refer to table 4.11). R^2 value, (coefficient of the determination) 0.367 indicated that 36.7% of employee retention could be explained by the seven independent variables.

Table 4.12 ANOVA Table

	Sum of Squares	df	Mean Square	F	Sig.
Regression	30.353	7	4.336	16.236	0.000
Residual	52.347	196	0.267		
Total	82.700	203			

F- statistic is used for testing if the null hypothesis should be rejected or supported. The F- statistic results combined with the p value indicated that the overall results obtained in the analyses were significant (Ramlan& Adnan, 2016). However, it is to be noted that it does not indicate that all the four independent variables have significant impact on employee retention. The above table shows explanatory variables are statistically significant i.e. the model is a good fit of the data $F=16.236$, $p\text{ value}<0.001$).

Table 4.13 Multiple Regression

	Unstandardized Coefficients		t	Sig.	95.0% Confidence Interval for B	
	B	Std. Error			Lower Bound	Upper Bound
(Constant)	1.176	0.275	4.282	0.000	0.634	1.718
Performance appraisal and future growth	0.216	0.067	3.219	0.002	0.084	0.349
Leadership support with work environment	0.088	0.063	1.398	0.164	-0.036	0.211
Training and development	0.191	0.068	2.823	0.005	0.058	0.324
Recruitment policy	0.053	0.058	0.909	0.364	-0.062	0.167
Employee benefits	0.205	0.054	3.819	0.000	0.099	0.311
Management support to employee	-0.065	0.057	-1.136	0.257	-0.178	0.048
Job security	0.030	0.048	0.617	0.538	-0.065	0.124

***Dependent Variable: Employee Retention**

The P values (Sig.) from above table illustrated that the Performance appraisal and future growth, Training and development and Employee benefits are statistically highly significant i.e. these three independents variables had significant impact on employee retention.

The coefficients (B) estimated how strongly the explanatory variables influenced the dependent variable (Ramlan& Adnan, 2016). According to the values of B and P it can be said that Performance appraisal and future growth had highest significant impact ($B=0.216$, $P=0.002$) on employee retention. Based on this analysis, strength of association of Employee benefits at second ($B=0.205$, $P<0.001$) followed by Training and development ($B=0.191$, $P=0.005$). Other four independent variables have no significant impact on employee retention. In this regression analysis our all independent variables are made on the basis of factor analysis. However, the overall scenario of coefficients with p -value is given in the following figure.

Figure 4.6 Graphical Representations of Multiple Regressions

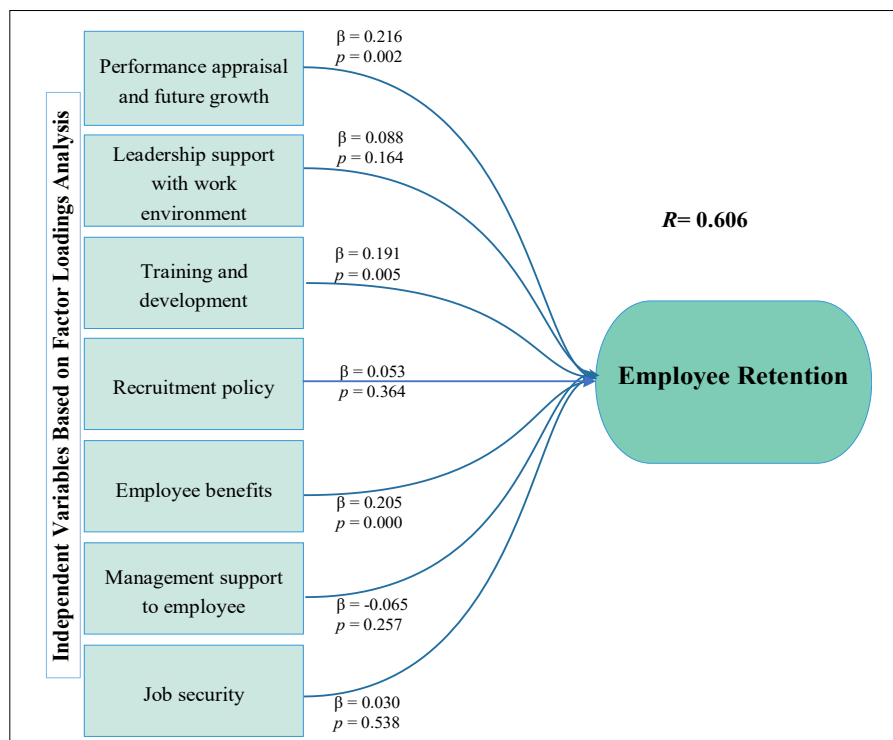

5. Conclusion and Recommendation

The main objective of the study was to examine the factors influencing employees' retention in the Private Banks of Bangladesh. The study based on the results of different statistical analysis showed that the ability of banks in Bangladesh to retain their existing employees depends on various factors. In this study we performed seven factors to investigate which are most influential factors to retain the employee. From the correlation study we observed that all these seven factors are highly correlated to the employee retention. This study also reveals that employee benefit is the most important factor to retain the employees of the organization. In our study, the employee benefits include salary structure, entertainment facilities and experience opportunities. The management of the bank should analyze the benefits of the peer banks within a certain interval and update the benefits for the employees of their organization. Respondents of this study, agree that the if the organization provides broad based training which expands their knowledge, skills and attitudes for efficient performance that is training acts as a retention tool. Respondents also argued that if the management of the bank encourages and supports training and ensures the training content is well designed and clear thus equipping them with skills, knowledge to bridge the gap between standard performance to the desired performance in the organization then employee retention rate will increase gradually for that organization. Training opportunities should also be evaluated by the management in order to increase performance and quality of the employees. The future growth opportunity is another important factor to retain the employees. If banks are to retain their existing employees, there is the need for them to pay much attention to these factors since by the nature of banks, customers develop trust and confidence in these banks if they meet the same employees they have develop friendship over time than frequently meeting different employees because of turnover.

References

- Ahmad, N., Iqbal, N. and Sheeraz, M., 2012. The effect of internal marketing on employee retention in Pakistani banks. *International Journal of Academic Research in Business and Social Sciences*, 2(8), p.270.
- An Gie Yong and Sean Pearce; A Beginner's Guide to Factor Analysis: Focusing on Exploratory Factor Analysis; *Tutorials in Quantitative Methods for Psychology*, 2013, Vol. 9(2), pp. 79-94, Doi: 10.20982/tqmp.09.2.p079

- Babbie, Earl R. *The Practice of Social Research*. 12th ed. Belmont, CA: Wadsworth Cengage, 2010.
- De Vaus, D. A. *Research Design in Social Research*. London: SAGE, 2001; Trochim, William M.K. Research Methods Knowledge Base. 2006.
- Duffield, C.M., Roche, M.A., Blay, N. and Stasa, H., 2011. Nursing unit managers, staff retention and the work environment. *Journal of clinical nursing*, 20(1-2), pp.23-33.
- Davidson, M. and Wang, Y. (2011). Sustainable labor practices? Hotel human resource managers views on turnover and skill shortages. *Journal of Human Resources in Hospitality and Tourism*, 10 (3), 235-253.
- Hong, E.N.C., Hao, L.Z., Kumar, R., Ramendran, C. and Kadiresan, V., 2012. An effectiveness of human resource management practices on employee retention in institute of higher learning: A regression analysis. *International journal of business research and management*, 3(2), pp.60-79.
- HamidahRamlan, MohdSharrizat Adnan; The Profitability of Islamic and Conventional Bank: Case study in Malaysia; *Procedia Economics and Finance* 35 (2016), pp. 359–367
- James, L. and Mathew, L., 2012. Employee Retention Strategies: IT Industry. *SCMS Journal of Indian Management*, 9(3).
- Johnson M (2000). *W inning the people wars: talent and the battle for human capital*. London: Prentice Hall.
- Karatepe, O. M. and Olugbade, O. A. (2009). The effects of job and personal resources on hotel employees' work engagement. *International Journal of Hospitality Management*, 28(4), 504-512.
- Kumar, R. (2014) *Research Methodology: A Step-by-Step Guide for Beginners*. 4th Edition, SAGE Publications Ltd., London.
- Lyria, R.K., Namusonge, G.S. and Karanja, K., 2017. The effect of talent retention on organizational performance of firms listed in the Nairobi Securities Exchange. *Journal of Human Resource and Leadership*, 1(3), pp.56-68.
- Mohlala, J., Goldman, G.A. and Goosen, X., 2012. Employee retention within the information technology division of a South African bank. *SA Journal of Human Resource Management*, 10(2), pp.1-11.
- Mohsen Tavakol, Reg Dennick; Making sense of Cronbach's alpha; *International Journal of Medical Education*, 2011; 2:53-55; ISSN: 2042-6372; DOI: 10.5116/ijme.4dfb.8dfd.
- Mwangi, E.K. and Omondi, M., 2016. Factors influencing staff retention in the banking industry in Kenya. A case study of equity bank limited. *Strategic Journal of Business & Change Management*, 3(2).
- Neter J, Wasserman W, Kutner MH. *Applied linear models: regression, analysis of variance, and experimental designs*. 3rd ed. Homewood, Ill: Irwin, 1990; 38– 44, 62–104
- Presbitero, A., Roxas, B. and Chadee, D., 2016. Looking beyond HRM practices in enhancing employee retention in BPOs: focus on employee–organisation value fit. *The International Journal of Human Resource Management*, 27(6), pp.635-652.
- Ritter, D. (2011). The Relationship between Healthy Work Environments and Retention of Nurses in Hospital Setting. *Journal of Nursing Management*, 11(19), 27-32.
- R.M. O'Brien, A caution regarding rules of thumb for variance inflation factors, *Qual. Quant.* 41 (2007), pp. 673–690.
- Sinha, D. & Shukla, S. K. (2013). A study of Employee Retention in the Pharmaceuticals sector in Dehradun City: *International Journal of Education and Psychological Research (IJEPR)* 2 (1), 30-39
- Salman, A., Ahmad, N. and Matin, F., 2014. Factors affecting on employees retention in banking sector: An investigation from Karachi. *European Journal of Business and Management*, 6(37), pp.2222-1905.
- Sandhya, K. and Kumar, D.P., 2011. Employee retention by motivation. *Indian Journal of science and technology*, 4(12), pp.1778-1782.
- Setia M. and SinghD.(2014). EMPLOYEE RETENTION: A CHALLENGE FACED BY INDIAN BANKING INDUSTRY- A STUDY. *International Journal of Current Research* Vol. 6, Issue, 11, pp.9856-9860, November, 2014.
- Tanchi, Khadiza Rahman, "Analyzing the Factors Influencing Employee Turnover in Private Commercial Banks in Bangladesh" *Daffodil International University Journal of Business and Economics*, Vol. 9, No. 1, PP. 119-130, June, 2015
- Yamamoto, H., 2011. The relationship between employee benefit management and employee retention. *The International Journal of Human Resource Management*, 22(17), pp.3550-3564.



Analysis of the Effect of Loan to Deposit Ratio, Non-Performing Loans and Capital Adequacy Ratio on Return on Assets with Good Corporate Governance as Intervening Variable in Banking Companies Listed in the Corporate Governance Perception Index (CGPI) for the Period 2014 – 2018

Viviana Tantiara Arsew¹, Zainul kisman¹, Ni Nyoman Sawitri¹

¹Universitas Trilogi, Indonesia

Abstract

The purpose of this study was to examine the effect of loan to deposit ratio (LDR), non-performing loans (NPL), and capital adequacy ratio (CAR) on return on assets (ROA) in banking companies listed on the Indonesian Institute for Corporate Governance (IICG) in 2014-2018. This study uses Good Corporate Governance (GCG) as an Intervening variable. The use of intervening variables GCG in this study is a recent breakthrough in increasing return on assets. The sampling technique is purposive sampling. With this sampling method, the samples used in the study were 10 of the best banking companies implementing Good Corporate Governance registered in The Indonesian Institute for Corporate Governance (IICG) in 2014-2018. This study uses secondary data obtained from SWA Magazine publications. The analysis technique used in this study is path analysis. The results of the first structural equation model that LDR and NPL have a significant negative effect on GCG and CAR has a positive significant effect. The results of the second structural equation model that NPL, CAR, GCG have an influence on ROA, but LDR does not have a significant effect. The implication of this research is that GCG as a very large variable intervening plays a role in banks in increasing ROA.

Keywords: Loan to Deposit Ratio, Non-Performing Loans, Capital Adequacy Ratio, Return on Assets, Good Corporate Governance

I. INTRODUCTION

I.1. Introduction and research rationale

The development of banking that is increasingly rapid at this time leads to increasingly fierce bank competition. As a financial institution that plays an important role in supporting the economy in Indonesia, banks face

increasingly complex risks and challenges. The risks and challenges faced by the bank are internal and external. Challenges from internal banks originate from the management of the bank itself, while external challenges from banks can originate from the economic conditions of a country where the bank operates. In addition, the condition of the country's economy which is the parent of foreign banks operating in Indonesia is also a challenge for banks. There are risks and challenges faced by banks, it is necessary to carry out an assessment related to the soundness of commercial banks in Indonesia. This assessment is intended so that commercial banks in Indonesia can survive in facing increasingly complex challenges and risks. Rating of the soundness of commercial banks is regulated in Bank Indonesia Regulation Number 13/1 / PBI / 2011 concerning Rating of Soundness of Commercial Banks. The assessment includes the integration of the bank's risk profile, Good Corporate Governance (GCG), profitability, and bank capital.

Liquidity is the company's ability to meet short-term obligations. These capabilities include the ability to provide funds when a customer requires withdrawal of deposit funds, the ability to provide funds when meeting credit requests without any delay, and the ability of a bank to maintain operational conditions in order to remain liquid (Fahmi, 2014: 117). The higher this ratio, the lower the liquidity of the bank concerned.

Financial ratios that can be used to measure credit risk are Non Performing Loans (NPL), this ratio measures the ability of banks to minimize the problem loans they face (Puspitasari, 2009).

Capital Adequacy Ratio (CAR) is a benchmark assessment of capital ratios in the context of the soundness of each bank. Capital adequacy is how a bank is able to finance its activities with capital ownership, in other words, CAR is used to measure the capital adequacy of banks to support assets that contain or generate risk, for example by granting credit to customers (Fahmi, 2014: 181).

Return On Assets (ROA) is a ratio used to show a company's ability to generate profits using total assets.

The following is empirical data about the variables used in this study, namely: loan to deposit ratio, non-performing loans, and capital adequacy ratio, return on assets (ROA) and good corporate governance. The selected sample is a banking company registered with the Indonesia Institute for Corporate Governance (IICG). Can be seen in Table 1.1 as follows :

Tabel 1: Average Banking Financial Ratios registered at The Indonesian Institute for Corporate Governance (IICG) in 2014-2018.

Variable	Years				
	2014	2015	2016	2017	2018
LDR (%)	84,95	85,91	84,61	84,97	87,22
NPL (%)	1,20	1,23	1,17	1,18	1,15
CAR(%)	17,01	17,96	19,70	19,73	19,83
GCG(score)	83,95	83,90	85,03	85,78	88,27
ROA(%)	2,50	2,40	2,42	2,53	2,70

Sources: Financial statement in IDX; data processed.

Based on table 1, it can be seen that the financial ratios of banks registered at banking companies registered at the Indonesia Institute for Corporate Governance (IICG) in the 2014-2018 period fluctuated each year. Increases and decreases in ROA are also followed by three independent variables: loan to deposit ratio, non-performing loans, capital adequacy ratio and good corporate governance as an intervening variable.

I.2. Research Objectives

1. Want to test how the influence Loan to Deposit Ratio, Non-Performing Loans, Capital Adequacy Ratio on Good Corporate Governance
2. Want to test how the influence of Loan to Deposit Ratio, Net Performing Loans, Capital Adequacy Ratio on Return On Assets.

II. LITERATURE REVIEW AND HYPOTHESIS FORMULATION

Grand Theory, Empirical Evidence and Hypothesis Formulation

Agency Theory

According to Atmaja (2018), Agency theory states that there is an asymmetry between managers (agents) and shareholders (principals) where managers are more aware of internal information and company prospects in the future compared to shareholders and other stakeholders. Principals will sacrifice their resources in the form of compensation received by the agent, with compensation given to the agent, the principal hopes to reduce differences of opinion and reduce actions that deviate from the interests of the principal. For this reason, principal will set rules such as GCG to oversee managers or banker.

Trade-Off Theory

According to Brigham, and Ehrhardt (2005). This theory explains the idea that how much is the company's debt and how much is the company's equity resulting in a balance between costs and profits. This theory states that a company has an optimal debt level and tries to adjust its actual debt level to the optimal point when the company is at a debt level that is too high (overleveraged) or too low (undelivered). In a stable condition, the company will adjust its debt level to the average level of the debt in the long run. Debt and equity balances are needed so that managers (agents) can achieve optimal company or bank ROA.

Signaling Theory

According to Brigham and Hosuton (2014), signaling theory is a behavior of company management in giving instructions to investors regarding management's views on the company's prospects for the future. In the framework of signal theory, it is stated that the impetus of the company to provide information is because there is information asymmetry between company managers and outsiders, this is because company managers know more information about the company and prospects to come than outsiders. By submitting this information to an external party, the external party is expected to provide a proportional and positive response. So the profit or ROA is optimal.

Relationship of Loan to Deposit Ratio to Good Corporate Governance.

According to Mulyono (1995), the LDR ratio is the ratio of the ratio between the number of funds channeled to the community (credit) with the number of community funds and own capital used. This ratio illustrates the ability of banks to repay withdrawals by depositors by relying on loans provided as a source of liquidity. The higher this ratio the lower the ability of bank liquidity (Dendawijaya, 2000).

The following are the results of previous studies: Kiswanto & Ari (2016) states that the Loan to deposit ratio has a significant effect on Good Corporate Governance.

Based on previous research above, it can be made a hypothesis of the relationship between the two variables as follows:

H1: LDR has a positive effect on GCG

Relationship of Non-Performing Loan to Good Corporate Governance.

According to Ismail (2009), Non-Performing Loan (NPL) is a situation where the customer is unable to pay part or all of his obligations to the bank as agreed. Each bank must be able to manage credit well in giving credit to the public and in returning credit according to the terms and conditions that apply so as not to cause problem loans.

According to Taswan (2006) and Kisman (2017), the ratio used to assess financial performance in managing non-performing loans is the NPL (Non-Performing Loan) ratio. Nonperforming loans are classified as Collectible, Current, Substandard, Doubtful and Loss. The smaller the NPL, the smaller the credit risk borne by the bank. Banks in conducting credit must conduct an analysis of the ability of debtors to repay their obligations. After credit is granted, banks are required to monitor the use of credit and the ability and compliance of debtors in fulfilling their obligations. The Bank conducts a review and binding of collateral to minimize credit risk. Banking practitioners agree that the safe limit of a bank's NPL must not exceed 5%.

Research by Ika Permata and Retno (2018), states that Net Performing Loans have a significant and positive effect on Good Corporate Governance.

Based on previous research above, it can be made a hypothesis of the relationship between the two variables as follows:

H2: NPL has a positive effect on GCG.

Relationship of Capital Adequacy Ratio to Good Corporate Governance

According to Kuncoro (2011), CAR is capital adequacy ratio that shows banks in maintaining sufficient capital and the ability of bank management to identify, measure, monitor, and control risks that arise that can affect the amount of bank capital.

According to Bank Central of Indonesia (Number 9/13 / PBI / 2007), CAR is the provision of minimum capital for banks based on broad risk assets, both assets listed in the balance sheet and administrative assets as reflected in obligations that are still contingent and / or commitments provided by banks for third parties or market risk. In other words, CAR is the ratio of bank performance to measure the adequacy of capital owned by banks to support assets that contain or generate risk, for example, loans.

Research by Kiswanto & Ari (2016), states that the Capital Adequacy Ratio has a significant effect on Good Corporate Governance.

Based on previous research above, it can be made a hypothesis of the relationship between the two variables as follows:

H3: CAR has a positive effect on GCG.

Relationship of Loan to Deposit Ratio, Non-Performing Loans, Capital Adequacy Ratio simultaneously to Good Corporate Governance

Based on the existing theories and previous research, the researcher wants to analyze the effect of Loan to Deposit Ratio, Net Performing Loans, Capital Adequacy simultaneously on Good Corporate Governance. How the relationship between variables above can be seen from the explanation below.

Banking liquidity (LDR) needs to be managed to meet the needs when customers take their funds and distribute loans (credit) to borrowers (debtors). If the LDR value is too high, it means that the bank does not have sufficient liquidity to cover its obligations to customers (depositor, third-party funds or in Indonesia called the DPK). Conversely, if the LDR value is too low, it means that banks have sufficient liquidity but their income (interest income) may be lower because as is well known, the banking world earns income through loans.

The higher Net Performing Loans can mean that the quality of bank credit is getting worse and the NPL ratio is not reasonable causing loss of opportunity to obtain income from loans and banks must accept losses and operational activities due to non-performing loans.

Capital Adequacy Ratio is the ratio of bank performance to measure the adequacy of capital owned by banks to support assets that contain or generate risk, for example, loans granted.

Based on relationship and previous research above, it can be made a hypothesis of the relationship between the four variables as follows:

H4: Loan to Deposit Ratio, Net Performing Loans and Capital Adequacy Ratio have simultaneously effect on Good Corporate Governance

Relationship of Loan to Deposit Ratio to Return On Assets.

Loan to Deposit Ratio (LDR) reflects the ratio between financing provided by commercial banks to their customers compared with funds that have been entered or collected from the public. Banks that have large total assets, have the opportunity to extend credit to the borrowers in large numbers, so as to obtain high profits (Alper et al., 2011). The size of the LDR ratio of a bank will affect bank profitability. The higher the LDR owned by a bank also shows that the bank's ability to obtain profits the better. So it can be said that LDR has a positive effect on ROA (Kisman,2017).

Research by Restiyana (2011) shows that LDR has a positive effect on ROA.

Based on previous research above, it can be made a hypothesis of the relationship between the two variables as follows:

H5: Loan to Deposit Ratio has a positive effect on Return On Assets.

Relationship of Non-Performing Loans to Return On Assets.

The NPL ratio shows the ability of bank management to managing non-performing loans provided by banks. The higher the NPL ratio, the worse the quality of bank credit that causes the number of problem loans is greater so that it can cause the possibility of a bank in a greater problematic condition.

The following are the results of several previous studies that Non-Performing Loans negatively affect ROA (Indah and Arief,2015). Meanwhile, according to Ayu (Aye et al.,2017) and Kisman (2017), that the Non-Performing Loan has a significant effect on profitability.

Based on explanation above, it can be made a hypothesis of the relationship between the two variables as follows:

H6: Non-Performing has negative effects on Return On Assets.

Relationship of Capital Adequacy Ratio to Return On Assets

According to Darmawi (2011), one component of the capital factor is capital adequacy. The ratio to test the bank's capital adequacy ratio is CAR (Capital Adequacy Ratio). CAR shows how far all bank assets that contain ratios that show how far all bank assets that contain risks (credit, inclusion of securities, bills at other banks) are financed from the bank's own capital funds in addition to obtaining funds from sources outside the bank, such as public funds, loans (debt), and others.

Research by Restiyana (2011) and Deden (2016), shows that the Capital Adequacy Ratio has a positive and significant effect on Return On Assets.

Based on previous research above, it can be made a hypothesis of the relationship between the two variables as follows:

H7: Capital Adequacy Ratio has a positive effect on Return On Assets.

Relationship of Good Corporate Governance to Return on Assets.

Research on good corporate governance provides empirical evidence that the variable of good corporate governance is an important factor in determining company value and influencing company profitability.

Good corporate governance also guarantees profit and security of funds invested in banks that will not be embezzled by bank managers. The implementation of good corporate governance can prevent mistakes in decision making so that it will automatically increase the value of the company, which is reflected in profitability.

Research by Anjani and Yadnya (2017) Good Corporate Governance has a significant effect on Return On Assets.

Based on previous research and explanation above, it can be made a hypothesis of the relationship between the two variables as follows:

H8: Good Corporate Government has a positive effect on Return On Assets.

Relationship of Loan to Deposit Ratio, Net Performing Loans, Capital Adequacy Ratio and Good Corporate Governance simultaneously to Return On Assets

Based on the existing theories and previous research, this study wants to analyze the effect of Loan to Deposit Ratio, Non-Performing Loans, Capital Adequacy Ratio and Good Corporate Governance simultaneously on Return on Assets. How the relationship between variables above can be seen from the explanation below.

Loan to Deposit Ratio, Non-Performing Loans, Capital Adequacy Ratio and Good Corporate Governance are of the ratio that can be used in terms of measuring the financial performance of the bank. Then the changes in the four ratios also partially affect ROA as explained above. In line with the partial influence above, it is simultaneously expected that LDR, NPL, CAR and GCG influence ROA.

Based on explanation above, it can be made a hypothesis of the relationship between the five variables as follows:

H9: Loan to Deposit Ratio, Non-Performing Loans, Capital Adequacy Ratio and Good Corporate Governance have simultaneously effect on Return On Assets.

Relationship of Loan to Deposit Ratio, Net Performing Loans, Capital Adequacy Ratio to Return On Assets with Good Corporate Governance as an intervening variable.

Loan to Deposit Ratio is a ratio that measures the extent of the bank's ability to repay withdrawals of funds made by depositors by relying on loans provided as a source of liquidity. The higher this ratio, the lower the liquidity of the bank concerned. But on the contrary, the lower the LDR ratio, the higher the liquidity of the bank concerned. This ratio is also an indicator of the vulnerability and ability of a bank.

A non-performing loan is a situation where the customer is unable to pay part or all of his obligations to the bank as agreed. Each bank must be able to manage credit well in giving credit to the public and in returning credit according to the terms and conditions that apply so as not to cause problem loans. The smaller the NPL, the smaller the credit risk borne by the bank.

Capital Adequacy Ratio is capital adequacy that shows banks in maintaining adequate capital and the ability of bank management to identify, measure, supervise, and control the risks that arise that can affect the amount of bank capital (Kuncoro, 2011).

Good Corporate Governance (GCG) is a healthy corporate governance procedure that has been introduced by the Indonesian government and the International Monetary Fund (IMF). This concept is expected to protect shareholders and creditors so that they can regain their investment.

Return On Assets is a ratio used to measure a company's ability to generate profits by using the total assets owned by the company after adjusting for costs to fund these assets (Hanafi and Halim, 2007).

Based on the description above, it can be seen that the independent variables with intervening variables in research affect each other and have a relationship with the dependent variable. The relationship that occurs between the independent variable and the intervening variable is expected to be an interrupting variable between the independent variable and the dependent variable so that the independent variable does not directly affect the emergence of the dependent variable.

Based on previous research and explanation above, it can be made a hypothesis of the relationship between the five variables as follows:

H10: Loan to Deposit Ratio, Non-Performing Loans, Capital Adequacy Ratio have an effect on Return On Assets with Good Corporate Governance as an intervening variable.

III. RESEARCH METHODS

III.1 RESEARCH METHODS

The object of this study is the Banking Companies listed on the Indonesia Stock Exchange, which have a score of Corporate Governance Perception Index of the Indonesian Institute for Corporate Governance Period 2014 - 2018. Types of data used in this study are secondary data, namely in the form of panel data for all related variables. The population in this study is banking with a total of 45 companies.

Based on sample selection, the total sample of Banking listed on the Indonesia Stock Exchange that has a score of Corporate Governance Perception Index of The Indonesian Institute for Corporate Governance (IICG) that meets the criteria is 10 companies listed on the Indonesia Stock Exchange in 2014-2018.

III.2. POPULATION AND SAMPLE

The population used in this study is that the banks listed on the Indonesia Stock Exchange have a score of 10 companies in the Corporate Governance Perception Index of the Indonesian Institute for Corporate Governance (IICG).

The sampling criteria for this study are as follows:

1. Banking Companies listed on the Indonesia Stock Exchange during the observation period, namely 2014 - 2018.
2. Companies that publish data on company financial statements that are published on the Indonesia Stock Exchange at the end of each year during monitoring, namely 2014 - 2018.
3. Banking Companies that have a Corporate Governance Perception Index of the 2014 Indonesian Corporate Governance Institute (IICG).

This study uses secondary data. Secondary data is data that has been processed by the relevant institution which is sourced from the financial statements of the related company that has been audited and published to the general public. The financial report data is obtained from the website of the Indonesia Stock Exchange through www.idx.co.id.

III.3 METHOD OF ANALYSIS

In this study, the analysis method is carried out by path analysis which is a development of the regression model. Through this path analysis, the regression equation involves independent and dependent variables by testing intervening variables. Path analysis can also measure the relationship between variables in the model both directly and indirectly.

III.4. DEFINITION ON OF OPERATIONAL VARIABLES

Dependent Variables

The definition of operational variables is very important in research. This is intended to avoid misunderstandings or differences in perceptions regarding the data to be collected. In this study Return On Assets are used as dependent variables.

Return On Assets is a ratio used to measure a company's ability to generate profits.

Independent Variables

Loan to Deposit Ratio (LDR)

Loan to Deposit Ratio (LDR) is the ratio between the total volume of credit extended by banks and the number of funds received from various sources. LDR is the company's financial ratio related to liquidity.

Non-Performing Loans (NPL)

Part of bank credit that is not smooth until the bad debt where the bank did not manage to pull it back

Capital Adequacy Ratio (CAR)

Capital Adequacy Ratio is the ratio of the adequacy of capital owned by banks to support assets that contain or generate risk, for example, loans granted.

Intervening Variable

GCG is a score of Corporate Governance Perception Index of The Indonesian Institute for Corporate Governance (IICG).

III.5. DATA ANALYSIS

The analysis technique used in this study is path analysis. Before the path analysis is carried out, the assumption of path analysis must first test. The test consists of normality, multicollinearity, and heteroscedasticity. The path analysis model is as follows:

Substructure Equation 1:

$$Y = \rho_{yx1} x_1 + \rho_{yx2} x_2 + \rho_{yx3} x_3 + \epsilon_1$$

Substructure Equation 2:

$$Z = \rho_{zx1} x_1 + \rho_{zx2} x_2 + \rho_{zx3} x_3 + \rho_{zy} y + \epsilon_2$$

Figure 1: Framework for Research Models

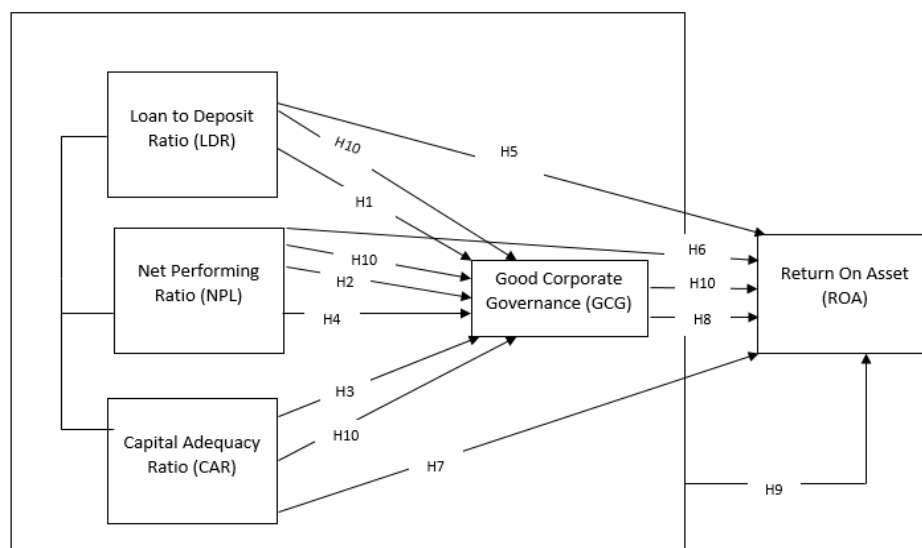

The application of GCG principles and practices will increase domestic investor confidence in the company. The benefits of implementing Good Corporate Governance (Daniri, 2014) can reduce agency costs and the cost of capital, and increase profitability (ROA) also the value of shares. The challenges of banking in the future not only lie in intense competition but also include weak banking capabilities, sustainable profitability and efficiency of bank operations, customer protection and information technology that still needs to be improved.

Trust and partiality in the interests of the community are a final estuary of banking integrity. Banking consolidation is based on three strengths, namely, capital-based, good corporate governance and corporate culture will be the eyes of the banking heart and are expected to illuminate national integrity. The application of GCG principles and practices will increase domestic and international investor confidence in the company and ultimately can increase profitability and value of shares.

IV. RESULTS AND DISCUSSION

Before conducting statistical analysis, the data to be processed, first must meet the regression analysis assumptions (Ghozali,2013).

TESTING OF THE REGRESSION ANALYSIS ASSUMPTION AND RESULT.

Substructure Equation 1:

Before conducting statistical analysis, the data to be processed, first must meet the regression analysis assumptions.

Table 2: One-Sample Kolmogorov-Smirnov Test (Normality Test)

		Unstandardized Residual
N		50
Normal Parameters ^{a,b}	Mean	,0000000
	Std. Deviation	,01240605
Most Extreme Differences	Absolute	,091
	Positive	,050
	Negative	-,091
Test Statistic		,091
Asymp. Sig. (2-tailed)		,200 ^{c,d}

a. Test distribution is Normal.

b. Calculated from data.

c. Lilliefors Significance Correction.

In table 2 above, the Asymp value is obtained. Sig (2- tailed) of 0.200 or can be written as a probability value (P-value) = 0.200 > 0.05 or Ho is accepted. Thus, residual data are normally distributed.

Table 3: Autocorrelation Test (Durbin- Watson) Model Summary

Model	R	R Square	Adjusted Square	R	Std. Error of the Estimate	Durbin-Watson
1	,696 ^a	,485	,451		,01280	,872

Source: data processed

From Table 3 above, the results of autocorrelation with Durbin - Watson are 0.872, which means that the autocorrelation category does not occur because the D-W number is between -2 to 2 (Singgih, 2013)

Table 4 : Tolerance dan VIF (Multicollinearity Test)

Model	Colinearity Statistics	
	Tolerance	VIF
1 (Constant)		
LDR	0,888	1,126
NPL	0,825	1,212
CAR	0,827	1,208

Source: data processed

Based on the results of testing the tolerance value (see Table 4 above) also shows that there is no independent variable that has a tolerance value below or less than 0.10, which means that there is no correlation between the

independent variables whose value is more than 95%. The results of the calculation of Variance Inflation Factor (VIF) also showed the same results, namely, there are no independent variables that have a VIF value ≥ 10 . So it can be said and concluded that there is no multicollinearity between the independent variables in the regression model.

Figure 2: Scatterplot graph (Heteroscedastisity Test)

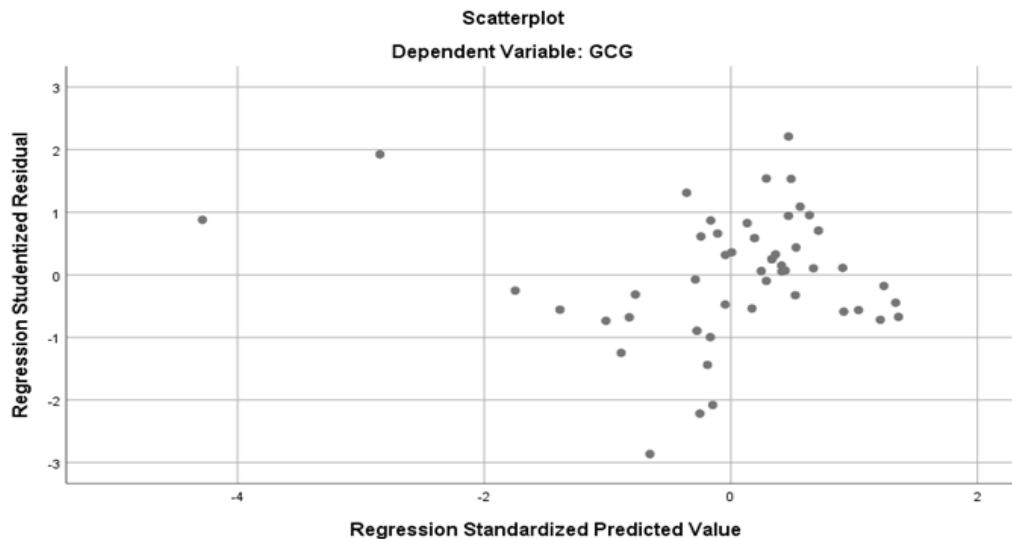

Based on Figure 2 above, there is a scatterplot graph that shows the points of diffuse and does not form certain clear patterns. So it can be concluded that there are no symptoms of heteroscedasticity.

Table 5: Summary of Results : Substructure Equation 1

Model	Standardized Coefficients B	t-test Sig.	Description	F-test and Sig.	R-Square
LDR → GCG	-,244	0,035	Significant	0.000 Significant	0.485
NPL → GCG	-,560	0,000	Significant		
CAR → GCG	,239	0,046	Significant		

Table 5 above is a summary table for substructural model equations 1. The data information contained in table 5 is derived from the processing of multiple regression analysis data. Table 5 will be used to assess whether the substructural 1 equation model is good enough (fit model) or not. Then the results in table 5 will be used to see the direct or non-direct effect on ROA in Figure 4.

Based on the table, the substructural 1 equation model is considered to be quite good (fit model) because all the independent variables (LDR, NPL and CAR) are significant and simultaneously also significant (see F-test). The R-squares are quite moderate. So overall the substructural 1 equation model and its coefficient information are valid and unbiased. Therefore we can draw conclusions using the data in table 5. Furthermore, the results can be used for the path analysis that is the basis of this research analysis (see Figure 4).

Substructure Equation 2:

Table 6: One-Sample Kolmogorov-Smirnov Test (Normality Test)

		Unstandardized Residual
N		50
Normal Parameters ^{a,b}	Mean	,0000000
	Std. Deviation	,34215523
Most Extreme Differences	Absolute	,091
	Positive	,091
	Negative	-,071
Test Statistic		,091
Asymp. Sig. (2-tailed)		,200 ^{c,d}

a. Test distribution is Normal.

b. Calculated from data.

c. Lilliefors Significance Correction.

d. This is a lower bound of the true significance.

Tabel 7: Autocorrelation Test (Durbin- Watson) Model Summary^b

Model	R	R Square	Adjusted Square	R	Std. Error of the Estimate	Durbin-Watson
1	,892 ^a	,795	,777		,35704	1,328

a. Predictors: (Constant), GCG, LDR, CAR, NPL

b. Dependent Variable: ROA

From Table 7 above, it can be seen that the Durbin-Watson value is 1.328 in the autocorrelation free region because it is between -2 to +2. So the decision taken in the autocorrelation test is accepted Ho, reject H1. It means that this test does not contain an autocorrelation problem. Thus it can be concluded that the regression equation model is free from autocorrelation symptoms.

Tabel 8: Tolerance dan VIF (Multicollinearity Test)

Model	Colinearity Statistics	
	Tolerance	VIF
1 (Constant)		
LDR	0,805	1,241
NPL	0,549	1,821
CAR	0,758	1,319
GCG	0,515	1,941

Source: data processed

Based on Table 8, the results of testing the tolerance value also shows that there is no independent variable that has a tolerance value below or less than 0.10, which means that there is no correlation between the independent

variables whose value is more than 95%. The results of the calculation of Variance Inflation Factor (VIF) also showed the same results, namely, there are no independent variables that have a VIF value ≥ 10 .

Figure 3. Scatterplot graph (Heteroscedastisity Test)

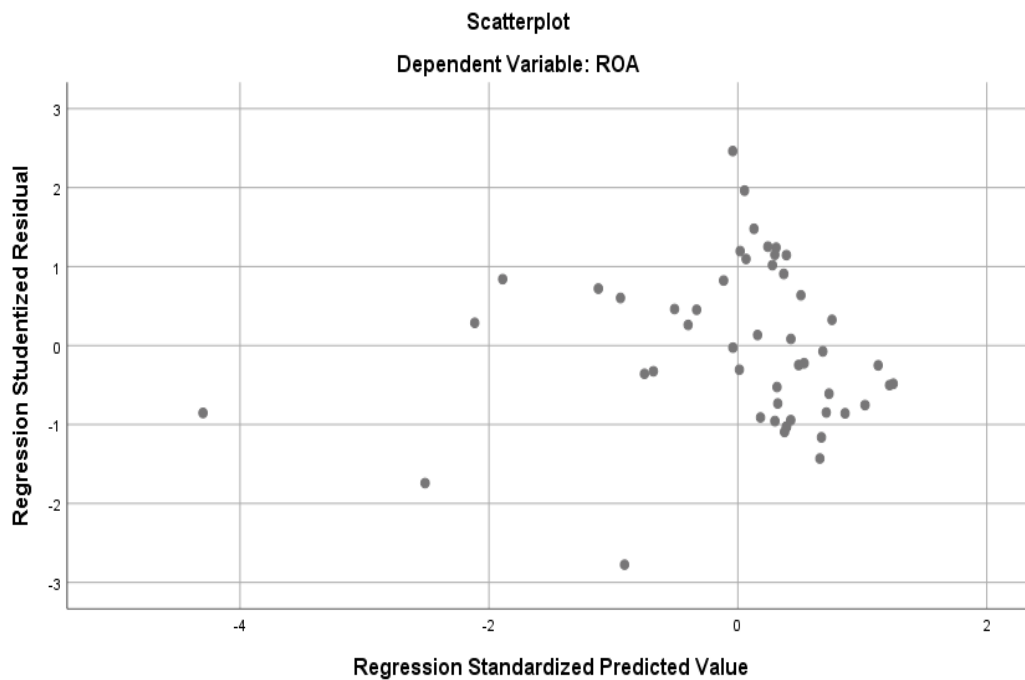

Based on Figure 3 above, there is a Scatterplot graph that shows the scattered points do not form a certain clear pattern. So it can be concluded that there are no symptoms of heteroscedasticity.

Table 9: Summary of Results: Substructure Equation 2

Model	Standardized Coefficients B	t-test Sig.	Description	F-test and Sig.	R-Square
LDR \rightarrow ROA	-.062	0.411	Not Significant	0.000 Significant	0.795
NPL \rightarrow ROA	-.505	0.000	Significant		
CAR \rightarrow ROA	.433	0.000	Significant		
GCG \rightarrow ROA	.175	0.006	Significant		

Table 9 above is a summary table for substructural model equations 2. The data information contained in table 9 is derived from the processing of multiple regression analysis data. Table 9 will be used to assess whether the substructural 2 equation model is good enough (fit model) or not. Then the results in table 9 will be used to see the direct or non-direct effect on ROA in Figure 4.

Based on the table, the substructural 2 equation model is considered to be quite fit because all the independent variables (NPL, CAR and GCG) except LDR are significant. LDR not significant because the size of the interbank credit that is sampled is very different. Simultaneously, all variables also significant (see F-test). The R-squares are high. So overall the substructural 2 equation model and its coefficient information are valid and unbiased. Therefore we can draw conclusions using the data in table 9. Furthermore, the results can be used for the path analysis that is the basis of this research analysis (see Figure 4).

Path Analysis

Path Analysis is to combine the data in Table 5 and Table 9 to see the direct and indirect effects in order to solve the problem of how to improve ROA by using GCG intervening variables.

Figure 4: Coefficient of Path Analysis

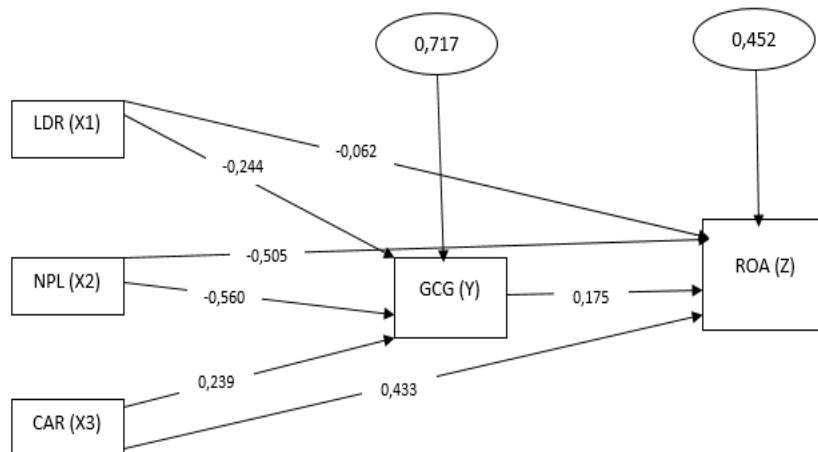

Source: data processed

The path coefficient interpretation is as follows:

- Effect of LDR on ROA :
Direct influence = -0,062
Indirect influence (through GCG) = $-0,244 \times 0,175 = -0,0427$
Total influence = $-0,062 + (-0,0427) = -0,1047$
- Effect of NPL on ROA
Direct influence = -0,505
Indirect influence (through GCG) = $-0,560 \times 0,175 = 0,098$
Total influence = $-0,505 + 0,098 = -0,407$
- Effect of CAR on ROA
Direct influence = 0,433
Indirect influence (through GCG) = $0,239 \times 0,175 = 0,0418$
Total influence = $0,433 + 0,0418 = 0,4748$
- The effect of GCG on ROA = 0,175

The above results are summarized in Table 10. Table 10 will be able to show the role of each variable influencing the ROA and the role of GCG as intervening variable.

Tabel 10: Summary of the Value of Direct Effects, Indirect Effects and Total Effects Between Variables

Influence of Variables	Direct influence	Indirect influence (through GCG) : intervening variable	Total influence
LDR (X1) → ROA (Z)	-0.062	$-0.244 \times 0.175 = -0.0427$	-0.1047

NPL (X2) → ROA (Z)	-0.505	-0.560 x 0.175 = 0.098	-0.407
CAR (X3) → ROA (Z)	0.433	0.239 x 0.175 = 0.0418	0.4748
GCG (Y) → ROA (Z)	0.175		0.175
LDR (X1) → GCG (Y)	-0.244		-0.244
NPL (X1) → GCG (Y)	-0.560		-0.560
CAR(X1) → GCG (Y)	0.239		0.239

Source: Data Process

Based on the above calculation Table 10, it can be concluded as follows:

1. Loan to Deposit Ratio has an indirect effect on Return On Assets, from the calculation results that the direct effect of -0.062 is smaller than the indirect effect - 0.0427(through GCG). Because LDR to ROA directly has no significant effect based on table 9. So it is better to influence LDR on ROA through GCG (intervening variable) than directly. This means that LDR in influencing ROA through GCG can be seen GCG as intervening variable and here plays a role in increasing ROA. This role is due to GCG improving loan management (LDR) and reducing the risk of bad credit (NPL) and capital management (CAR). So that the overall total LDR effect on ROA increases when managing GCG better.
2. Non-Performing Loans have an indirect effect on Return On Assets, from the results of calculations that the direct effect of -0.505 (lowers ROA).But indirect effect of 0.098 (through GCG). This path also shows that GCG acts as an intervening variable from NPL to ROA. Like the LDR to ROA path. NPL has an effect on increasing ROA through the application of GCG because the decrease in NPL in this period has an impact on improving GCG scores. An increased GCG score means better bank governance. Furthermore, it affects the increase in ROA. So once again here the role of GCG as an intervening variable between NPL and ROA is clearly seen because it increases ROA. The role of GCG has also been shown in the upper path between the influence of LDR on ROA through GCG. GCG here shows its role of reducing smaller ROA decreases due to an increase in NPL when there is GCG as an intervening variable.
3. Capital Adequacy Ratio has a direct effect on Return On Assets, from the calculation results that the direct effect of 0.433 , and this increase in ROA will increase if the bank applies GCG. The addition of ROA due to CAR (through GCG) is 0.0418. So that overall ROA increases higher than not applying GCG. Capital Adequacy Ratio is the ratio of bank performance to measure the adequacy of capital owned by banks to support assets that contain or generate risk. The increasing quality of CAR will be an influence on the increase in profits shown by ROA, this is very supportive for the continuity of business activities more adequately on capital, the tendency of an increase in profits generated on assets will also increase. So that this condition needs to be maintained by the Bank, or more enhanced its CAR because more CAR increases automatically raise the public's trust in the Bank that optimal management of CAR can increase the value of GCG.
4. The role of GCG can improve ROA. And that role can be seen by comparing the direct influence of each variable and indirectly through intervening. By intervening in good corporate governance, the effect of using GCG is higher than not using GCG. This shows that GCG has a role in increasing ROA due to changes in LDR, NPL and CAR variables. This means that if a bank wants to increase profits, not only loans, bad loans and capital should be considered, but the Good Corporate Government must also be maintained.

V. CONCLUSION

Based on the results of statistical tests obtained after data collection, data processing, hypothesis testing, and analysis and discussion related to the research hypothesis, the researcher draws the conclusions as follows:

1. Simultaneously the variable loan to deposit, non-performing loans, capital adequacy ratio have significant effect to good corporate governance.
2. Through intervening good corporate governance variables, simultaneously the non-performing loans, capital adequacy ratio, good corporate governance have a significant effect on return on assets. Partially,

non-performing loans, capital adequacy ratios, good corporate governance have an influence on asset returns, But the loan to deposit does not have a significant effect.

VI. RECOMMENDATION

Based on the results of research and discussion, there are several suggestions that can be given, including:

1. For the management of banking companies to be prudent in managing funds and liquidity in accordance with the principles of good corporate governance. Companies that manage policies in managing liquidity in accordance with applicable banking regulations and principles of good corporate governance (ALMA).
2. For the public, investors or potential investors, to be more careful in analyzing the factors that influence return on assets. In seeing the effect of variables on return on assets, it is better to include good corporate governance (GCG) as an intervening variable. Considering that GCG will increasingly look at the effect of each variable on ROA. Thus increasing the decision taken. This research has provided evidence.
3. For future researchers, it is better to add an analysis of the influence of other variables not used in this study for better results.

References

- Ari, Anjani Luh Putu ., Yadnya, I Putu . 2017. Pengaruh *Good Corporate Governance* terhadap profitabilitas pada perusahaan perbankan yang terdaftar di BEI. E-Jurnal Manajemen Universitas Udayana. Volume 5 Tahun 2017.
- Auliya, Rizka. 2014. Pengaruh *risk, Good Corporate governance, earning* dan *capital* terhadap profitabilitas pada bank umum swasta nasional devisa di Indonesia. STIE Perbanas Surabaya.
- Bernardin Deden Edwar Yokeu. 2016. Pengaruh *Capital Adequacy Ratio dan Loan to Deposit Ratio* terhadap *Return on assets*. E-Journal Ekonomi dan Bisnis Universitas Bina Sarana Informatika. Volume 4 Nomor 2 Tahun 2016.
- Budi, Ni Luh Putu., Wiagustini, dan Ida Bagus. 2017. Pengaruh kecukupan modal dan risiko kredit terhadap profitabilitas likuiditas sebagai pemediasi pada bank perkreditan rakyat di kabupaten badung. E-Jurnal Ekonomi dan Bisnis Universitas Udayana. Volume 6 Nomor 6 Tahun 2017.
- Dewi, Ni Kadek Venimas, Wayan Cipta, dan I Ketut Kirya. 2015. Pengaruh LDR, LAR, DER dan CR Terhadap ROA. E- Journal Bisma Universitas Pendidikan Ganesha Jurusan Manajemen. Volume 3 Tahun 2015.
- Frisca, Frisilia., Raisa Pratiwi. 2014. Pengaruh *Good corporate governance*, Likuiditas dan ukuran perusahaan terhadap profitabilitas pada Perusahaan BUMN yang termasuk dalam IICG dengan struktur modal sebagai variabel intervening. STIE Multi Data Palembang.
- Hevy, Komang. 2019. Pengaruh *Good Corporate Governance* terhadap Profitabilitas Perbankan dengan Risiko Kredit sebagai Variabel Intervening (Pada Perbankan yang Terdaftar di BEI Periode 2014 -2016). Universitas Mataram. (e-ISSN: 2477-1767:vol7.no1- Maret-2019).
- Ika Permatasari, Retno Novitasary. 2013. Pengaruh Implementasi *Good Corporate Governance* terhadap Permodalan dan Kinerja Perbankan di Indonesia Manajemen Risiko sebagai Variabel Intervening. Universitas Negeri Surabaya.
- Indah Dwi, Arief. 2015. Pengaruh Non Performing Loan (NPL) dan Capital Adequacy Ratio (CAR) terhadap profitabilitas. Universitas Negeri Semarang.
- Kisman, Z. Model for Overcoming Decline in Credit Growth (Case Study of Indonesia With Time Series Data 2012m1-2016m12). Journal of internet Banking and Commerce. Vol.22,2017.
- Kiswanto dan Asri Purwanti. 2016. Pengaruh Tingkat Kesehatan Bank menurut Risk Based Rating terhadap Kinerja Keuangan dengan *Good Corporate Governance* sebagai Variabel Intervening pada umum Syariah dan Unit Usaha Syariah di Indonesia. E-Jurnal Akuntansi Indonesia Universitas Unissula, Vol.5 No.1 2016.
- Permatasari Ayu Nur, Dadan Rahadian dan Irni Yunita. 2017. Pengaruh CAR, LDR, BOPO, NPL dan Ukuran Perusahaan terhadap Profitabilitas (Studi Kasus pada Bank Umum Swasta dan Bank Devisa di Indonesia periode 2012 -2015). E-Proceeding of Management Universitas Telkom: Vol.4 No.2 2017.
- Pedoman Umum Good Corporate Governance Indonesia 2006.*
- Peraturan Bank Indonesia Nomor : 13/1/PBI/2011 tentang Penilaian Tingkat Kesehatan Bank Umum.
- Peraturan BI No. 8/14/PBI/2006 tentang Pelaksanaan *Good Corporate Governance* bagi Bank Umum.
- Prinsip Dasar Pedoman *Good Corporate Governance* Perbankan Indonesia, diterbitkan oleh Komite Nasional Kebijakan Governance

- Restiyana. 2011. Analisis pengaruh CAR, NPL, BOPO, LDR, dan NIM terhadap Profitabilitas Perbankan. Universitas Diponegoro Semarang.
- Riski Agustiningrum. 2018. Pengaruh antara *Capital Adequacy Ratio* (CAR), *Non performing Loan* (NPL), *Loan to Deposits Ratio* (LDR). E-Jurnal Manajemen Universitas Udayana. Volume 2 Nomor 8 Tahun 2018.
- Sandra, Kurniawati, Zilal Hamzah, dan Tri Kunawangsih. (2018). Analisis Pengaruh CAR, LDR, DER, BI Rate dan Inflasi Terhadap ROA Pada 10 Bank Besar di Bursa Efek Indonesia. Seminar Nasional Cendekiawan 4 Tahun 2018.
- SE BI No. 13/24/DPND petunjuk pelaksanaan Peraturan BI No. 13/I/PBI.2011 25 Oktober 2011 Penilaian Tingkat kesehatan Bank Umum.
- Sri Wahyuni Rasyid. 2012. Analisis Pengaruh Loan to Deposit ratio (LDR) Net interest margin (NIM) dan efisiensi terhadap return on assets (ROA) Bank Umum Indonesia. Universitas Hasanuddin.
- Otoritas Jasa Keuangan, Booklet Perbankan Indonesia 2014. ISSN : 1858-4233 Departemen Perizinan dan Informasi Perbankan, , Edisi 1, Maret 2014.



Human Resources Management Practices and Total Quality Management (TQM) is the Precondition to Gain the Sustainable Competitive Advantage in the Bangladesh Ready-Made Garments Sector

Farhana Rashid¹, Che Azlan Taib², Rushami Zien Yusoff³, Mohd Akhir Hj. Ahmad⁴

¹ School of Technology Management and Logistics, Universiti Utara Malaysia, Malaysia United International University, Bangladesh. Email: farhana_rashid@oya.uum.edu.my

² School of Technology Management and Logistics, Universiti Utara Malaysia, Malaysia. Email: c.azlan@uum.edu.my

³ College of Business, Universiti Utara Malaysia, Malaysia. Email: rzy278@uum.edu.my

⁴ School of Technology Management and Logistics, Universiti Utara Malaysia, Malaysia. Email: makhir@uum.edu.my

Abstract

Bangladesh Garments manufacturing industry is expanding at a rate of 20% per year and around 76% of the export earnings are came from RMG sector (BEPB, 2018). Currently 4.2 million workers are working in this sector where 4490 manufacturing units are in operation (BGMEA, 2018). Bangladesh Ready-Made Garments (RMG) shows remarkable growth and significant contribution in the country's economic development though product and service qualities are yet a considerable problem to worry about. RMG companies in Bangladesh are not fully aware about the impacts and value of Total Quality Management (TQM) implementation. At the same time, Bangladesh garments industry fully labor intensive rather than technology oriented as Bangladesh is the cheapest labor country, the average labor cost per hour is only \$0.3. Researchers argue that effective implementation of HRM and TQM practices is a main criteria and predictor of gaining sustainability in business. As, it is notable to mention that in case of Bangladesh RMG sector most of the existing literature give more emphasis and discuss about the infrastructural and strategic matters whereas TQM and Human Resource Management (HRM) practices in an attempt to improve sustainable competitive advantage is still a debate both theoretically as well as empirically. In this research tried to point out that HRM practices and TQM are positively related to organizational sustainable competitive advantage. In this aspect, literatures proved that, HR practices didn't get much attention which need to be measured and analysis in the aspect of Bangladesh RMG sectors quality performance improvement as in RMG sector human resources is the main advantage for industrial growth and sustainable competitive advantage in business. So this study is required to lift up this expectation to fulfill this research gap So there is a huge gap for further research. Proposed research direction and conclusion are discussed in conclusion of this research.

Keywords: Total Quality Management, Sustainable Competitive Advantage, Human Resource Management practices, RM

INTRODUCTION

Cost of poor quality of Bangladesh ready-made garments amounted to 18 percent of the operating costs (BGMEA, 2018). The RMG industry has been Bangladesh's key export industry and a main source of foreign exchange for the last 25 years though poor quality of products and services are considerable factor for the development of this sector.

Meanwhile the apparel sector, all the Bangladeshi garment companies are producing at the low end of the market (Rahman and Masud, 2011). Basically they are performing cutting, making and trimming (CMT) activities (Abdullah and Yusuf, 2008; Johir, Saha, and Hassan, 2014). Therefore, this industry takes maximum lead time to process an order (Yunus and Yamagata, 2012). According to Rahman and Anwar (2011) in Bangladesh the lead time for apparel export varies between 90-120 days, whereas the time for Sri-Lanka is about 19-45 days, China 40-50 days and for India 50-70 days for similar products.

Cost of poor quality of Bangladesh ready-made garments amounted to 18 percent of the operating costs (BGMEA, 2015). In this regard, Sharmin Akhter (2014) stated that the theory of quality management is new in Bangladesh RMG sector and the state is in a limited understanding condition. In contrast of few organizations that have adopted quality management practices have experienced an overall improvement in corporate performance (Rahman, 2010). However, according to Mamun and Islam (2012) in nearly all cases, TQM organizations achieved better employee relations, higher productivity, better customer satisfaction, increased market share and improved profitability. According to Sharmin Akhter (2014) little research has been conducted in TQM practices area in Bangladesh Ready-Made Garments sector. According to Jha and Joshi (2010) in today's global competition and economic liberalization, quality has been considered as an important factor for achieving competitive advantage. In case of Bangladesh Ready-made Garments companies, rather than take the whole process, most local authorities narrowed down their quality approach to few operations in order to cut cost (Sawhel, 2012). TQM practices is always the most neglected field of research in case of Bangladesh RMG sector as very few research have been conducted in this area (Rahman and Masud, 2011; Ferdousi and Shabnam, 2013). So there is an unsolved and emerging research argument in the field of TQM practices in Bangladesh RMG sector is yet need to be answered. However, many garments companies in Bangladesh don't have full knowledge and awareness about the effective implementation of TQM practices whereas they only use and stressed on ISO 9000 which sometimes cause problems (Shareef, Vinod and Kumar 2008; Ariful, Nasima and Rashed, 2012). In this regard, according to Sohail and Teo (2003) the certification of ISO 9000 is the initial step of TQM implementation though survey shows that few researchers stressed only on total quality management practices exclusively. Heras et al. (2012) also verified the result of these studies. So their study concluded with the view that the application of ISO 9000 concept is primary initiative and TQM is contribute further towards the development and ensure organizational quality performance. As Bangladesh RMG sector is now only used ISO 9000 which need to transformed and transit to TQM implementation. So this research will help to explore this research gap.

On the other hand, according to Seddiqe and Basak (2014) Human Resource is the most important asset for Ready-made Garments industry in Bangladesh. Bangladesh RMG sector should focus on proper implementation of HR policies to emphasis quality performance (Absar and Mahmood, 2014). As each organizations success and quality goal accomplishment is largely depends upon the capabilities of human resources (Budhwar and Debrah, 2011). In this regard according to Rahman (2012) against technological scenery, a thorough analysis of human resource management practices on manufacturing industries especially on Bangladesh RMG sector is very much needed. HRM practices are immensely necessary for the achievement and ensuring quality performance in the organization. It is not secondary rather an crucial and major elements for the implementation of TQM practices (Abbas, 2012). TQM studies related to HR practices can be found in the operations management literature but paid little attention to human resources issues towards gaining sustainable competitive advantage (Shahi, Faisal and Aftab, 2014; Issac et al., 2014). According to Alsuhaيمي (2012) indirect effects (mediation) of HRM have been neglected in most empirical research specifically in quality management area. These issues are more significant in Bangladesh RMG sector as never tested the mediating role of HRM practices in the aspect of TQM and sustainable competitive advantage (Ferdousi and Shabnam, 2013). So there is a huge research gap in this area which needs to justify further.

However, Bangladesh has reached and gains a remarkable development especially in inexpensive workforce context of RMG sector still its development and continuity of growth is not assured (Adhikari and Weeratunge, 2007). In this respect, according to Fasil and Osada (2011) TQM practices are the precondition for the continuous development of business to cope up with the current competitive market and globalization. For identifying the need of TQM practices in Bangladesh RMG sector, it already focused and start working on using quality control issues but unfortunately due to structural difficulties and inflexible hierarchical difficulties quality goals not achieved (Sharmin Akhter, 2014). So, the defining role of TQM implementation in predicting to gain sustainable competitive advantage in Bangladesh RMG context is required (Lee, 2012). Hence, the purpose of this study is to generate research idea for investigation the potential link and association of TQM practices in Bangladesh RMG sector to gain sustainable competitive advantage mediated by Human Resource Management practices.

SIGNIFICANCE OF THE STUDY

To promote and facilitate TQM adaptation in RMG sector in Bangladesh, this research result will contribute significantly. The levels of service offered by ready-made garments companies in Bangladesh were not always acceptable to customers. However, this study is immensely significant for Bangladesh Ready-Made garments companies as for the growing competition, imposition of various new rules and regulations in global business context. The necessity of this research can be justified. One, almost every organization need to develop a quality environment to ensure the quality performance. Two, the purpose of the organizations are mainly to variegate the competitive market as well as boost up the export and revenue through quality performance. Three, to cope up with the changing market condition and ensuring quality performance, organizations need to involve every employee as well as gain commitment. Four, ensuring customer satisfaction is the precondition of business success and sustainability. Five, the importance of group work and an interdisciplinary research was firmly recommended. As well as the findings of this study will be useful to government and other organizations in Bangladesh that are currently implementing TQM practices, as well as those seeking to establish TQM practices within their systems with the aim of improving performance as well as gaining sustainable competitive advantage of their businesses (Chowdhury, Ahmed, & Yasmin, 2014). The current study offers significant values for practitioners since it has considerable managerial significance. At the same time, this research will be significant in Bangladesh garments sector by offering new insights into the various TQM as well as HRM functions. The results of the study will enable buyers as well as customers to buy products from Bangladesh without worrying about the quality standard of products and services. Clearly, theoretical contribution of this study is significant because the research model will form theoretical and practical variables to relate TQM, HRM practices and sustainable competitive advantage. These initiatives will cover the latest research gap on the implementation of TQM, HRM as well as gaining sustainability in the literature. Additionally, it is believed that this study can be replicated in other context such as other product and service industries in Bangladesh. Therefore, this study will assist and explore for future research prosperities and opportunities in TQM area of research. Another relevance of this study is to serve as a guide for researchers who focus on quality management to strategize and help maintain competitive advantage of a given government through implementation of TQM practices (Fahmida Khatun, 2015). Overall, this research can help to build up remarkable understanding of practicing TQM in Bangladesh RMG sector as well as contribute significantly in building the scientific knowledge in the subject of the research area.

LITERATURE REVIEW

Human Resource Management

Generally, Human resource management (HRM) is the governance of an organization's employees. Absar (2014) denoted that due to lack of proper HR policies and procedures, labour-intensive manufacturing firms are facing shortage of workers, and high job turnover in developing countries such as Bangladesh. Shahin and Basak (2014) stated that Human Resource is the most important asset for Ready-made Garments industry in Bangladesh for implementing TQM properly. In Bangladesh context very few researchers have been conducted though the importance of HRM practices are immensely important for organizational development, growth and sustainability (Ahamed, 2013). In this regard according to Hossan, Rahman and Rumana (2012) there is a rapid growth of industrialization in Bangladesh, yet, the realities for Bangladesh RMG sector is that their people remain

undervalued, under trained and underutilized. So the potential growth and prospect in Bangladesh RMG sector is huge. And for using this opportunities it should focused on proper implementation of HR policies to emphasis quality performance (Weeratunga, 2003; Absar & Mahmood, 2014).

Pfeffer (1994) introduced 16 HR practices which denote best practice. In context of Bangladesh ready- made garments industry and TQM implementation, in this research we consider the following four practices: recruitment and selection, job analysis, manpower planning, equal employment opportunity act (EEOA).

The main focus of recruitment and selection process is the choosing the right person for the right position. According to Mládková (2005), "workers must be able and willing to cooperate and communicate and accept the way of sharing their knowledge (skills, abilities and experience) based on reciprocity, reputation and altruism." Schuler (1987) give emphasised in his study on more general, implicit and less formalised selection criteria are proposed by some authors. In Bangladesh ready-made garments, they don't follow any defined recruitment and selection policies which largely affect employees' turnover and competitiveness (Ahamed, 2013). On the other hand, Geisler stated that, "manpower planning is the process – including forecasting, developing and controlling by which a firm ensures that it has- the right number of people, the right kind of people, at the right places, at the right time, doing work for which they are economically most useful." Manpower planning is associated with organizational optimum size of workforce, appropriate training design, compensation system design as well as the future vision of the workforce management which are highly recommended in case of TQM practices in Bangladesh RMG sector (Ahamed, 2013). According to Bansari (2010), "most garments factories in Bangladesh pay little attention to labour standards and labour rights, disallow trade union activities, unsafe working environment, and ineffective laws and discard fair labour practices, and compliance enforcement is limited and limited role of stakeholders." According to Ahamed, F. (2011), "there is a rising fear in Bangladesh that the readymade garments sector may face a decline in demand and social compliance in the RMG industry is a key requirement for most of the world's garments buyers which ensures labour rights, labour standards, fair labour practices and a Code of Conduct."

So for ensuring quality practices and gaining sustainability in RMG sector of Bangladesh much attention should be given to EEO approach to avoid labor unrest and lack of quality performance. Job analysis is required huge impact for starting to implement any HR practices in organization (Sharmin, 2014). According to Cascio (1991) for evaluating the organizational performance effectively job analysis also associated with performance management and compensation, recognition and reward. Therefore, according to Dobbins et al. (1991), individual skills and competencies are focused in job analysis which is needed for empowering employees which is essentially significant in case of TQM implementation. Lastly, According to Shahin and Basak (2014) measuring job fitness is also a part of job analysis process which includes change management, job classification, creativity, and job design and job rotation. In this research, job analysis requires more significant attention in context of Bangladesh ready-made garments industry to gain sustainable competitive advantage for implementing TQM.

Therefore, according to Absar (2014) HRM practices were not given proper acknowledgements and preferences in aspect of Bangladesh RMG sector. So based on literature it is easily understandable that HR practices didn't get much attention which need to be measured and analysis in the aspect of Bangladesh RMG sectors quality performance improvement as in RMG sector human resources is the main advantage for industrial growth and sustainability in business. So this study is required to lift up this expectation to fulfil this research gap.

Total Quality Management

For defining quality there is no unison. Various researchers define the concept of quality in various ways. Quality Gurus defined quality and total quality management in numerous ways, such as, Deming, Crosby, Juran, Garvin, Feigenbaum and Ishikawa etc. every one gave various types of definition. Garvins definition was very remarkable; he defined quality in respect of industry based, usage based, service and product based, theoretical based, customer based approaches. Eight attributes of measuring service and product quality is also mentioned by him (Garvin, 1987). According Juran quality is "fitness for use." Planning of quality, control of quality as well as quality

improvement is the quality trilogy which was also mentioned by Juran. According to Crosby, "quality is the conformance to requirements or specifications and requirements are based on customer needs."

Zero defect quality improvement plans to achieve performance improvement which consist 14 steps also mentioned by Crosby (Kruger, 2001). Deming defined, "quality is a predictable degree of uniformity and dependability, at low cost and suited to the market". To enhance and ensure the performance as well as productivity, Deming also mentioned 14 quality management principles. To improve organizational performance Ishikawa insist on the importance of total quality control. Ishikawa diagram (the fish bone diagram), the cause and effect diagram is also Ishikawa's contribution to identify quality issues and problems (Kruger, 2001). Feigenbaum denoted the ideas and views of organization wise total quality control. And most interestingly he was the initial user of the concept of total quality control in the literatures of quality aspect. According to Feigenbaum, "quality is the total composite product and service characteristics of marketing, engineering, manufacturing and maintenance through which the product and service in use will meet the expectations by the customer" (Kruger, 2001). The significant elements of these quality development concepts consists commitment of management, strategic quality system approach, measurement of quality, improvement of process, training and development and reducing the various symptoms and reasons of problematic incidents. TQM always give emphasis on customer satisfaction to ensure quality culture by using continuous improvement concept. According to Kanji and Wallace (2000), "this culture varies both from one country to another and between different industries, but has certain essential principles which can be implemented to secure greater market share, increased profits, and reduced costs."

Rao et. al (1996) illogically, TQM should be the set of practices that enable an organization to deliver quality products or services.

TQM defined as ...

- The way of managing organization to achieve excellence
- Total – everything
- Quality - degree of excellence
- Management – art, act of way of organizing, controlling, planning, directing to achieve certain goals

According to BS4778:1991, TQM is a management philosophy embracing all activities through which the needs and expectations of the CUSTOMER and COMMUNITY, and the objectives of the organization are satisfied in the most efficient and cost effective manner by maximising the potential of ALL employees in a continuing drive for improvement."

However, According to Zairi and Youssef (1995), "management awareness of the importance of total quality management, alongside business process reengineering and other continuous improvement techniques was stimulated by the benchmarking movement to seek study, implement and improve on best practices." Originally management commitment and continuous improvement was developed in aspect of using in manufacturing industries though later service sector also included in the usage categories, such as use teller transactions in case of bank's service, processing order in various catalog organizations, etc.). Therefore, to identify various critical factors for TQM, many researches were conducted as well as lots of identified by many researchers as well as academicians and organizations such as "Malcolm Baldrige Award, EFQM (European Foundation for Quality Management), and the Deming Prize Criteria". On the basis of these researches, a vast majority of managerial concepts, tools, methods, process and strategic system have been developed. For measuring the organizational performance Saraph et al. (1989) identified and mentioned 78 items that were categorized in to eight critical factors of TQM. These are: "Role of divisional top management and quality policy, role of the quality department, training, product and service design, supplier quality management, process management, quality data and reporting, and employee relations." Other researchers Flynn et al. (1994), suggested other tools to identify major critical factors of TQM. They mentioned seven factors of quality. These are "top management support, quality information, process management, product design, workforce management, supplier involvement, and customer involvement." It's mentionable that Saraph et al. and Flynn et al., their recommended elements are quite identical. Flynn et al.

identified the influence of TQM practices in aspect of performance of quality and gaining competitive advantages of the organizations. In this regard, other significant study, Anderson et al. (1994) mentioned the basic concepts of TQM practices on the basis of Deming's 14 principles. By using the Delph technique they could able to reduce the number of elements from 37 to only 7. The elements are: "visionary leadership, internal and external cooperation, learning, process management, continuous improvement, employee fulfillment, and customer satisfaction." On the basis of the Malcolm Balridge Award measurement tools, Black and Porter (1996) suggested critical factors for TQM. Actually they formulated 32 elements which were categorized into 10 different categories of critical factors which are: "corporate quality culture, strategic quality management, quality improvement measurement systems, people and customer management, operational quality planning, external interface management, supplier partnerships, teamwork structures, customer satisfaction orientation, and communication of improvement information."

On the basis of thorough investigation of literatures Ahire et al. (1996) also recommended 12 elements to measure critical factors of TQM of firms. The 12 factors are: "supplier quality management, supplier performance, customer focus, statistical process control usage, benchmarking, internal quality information usage, employee involvement, employee training, design quality management, employee empowerment, product quality, and top management commitment." Motwani (2001) denoted, "TQM as constructing a house." Firstly, he considers top management commitment as the base line concept. For a better house construction of base line or foundation is essential. After that "employee training and empowerment, quality measurement and benchmarking, process management, and customer involvement and satisfaction" should be assured and placed. All these elements are considered as the basic four concepts of constructing a house. When the four concepts or pillars are developed properly then time to give emphasis on product manufacturing and design as well as service quality which are the end step of ensuring TQM practices of organization. In this regard, generally many researchers have been mentioned that the center of effective implementation and execution of TQM practices is top management commitment and capability to work as a visionary leader to cope up with the continuous changing and competitive market (Absar & Mahmood, 2011). Literatures also showed the necessity of training for the effective implementation of TQM practices (Palo & Padhi, 2003; Quazi, Hong, & Meng, 2002). In this respect, Wali, Deshmukh and Gupta (2003) also work on selecting TQM elements for organizational success. Though, their research work focused on quality gurus works only. In Bangladesh few researchers (Rahman and Masud, 2011; Alsuhaيمي, 2012; Parul Akhter, 2015) work haven been found which was concentrated only on the TQM elements which were proposed by Ahire, Golhar and Waller (1996) as well as they tried to relate it with Bangladeshi context.

In their research they mentioned twelve TQM elements which are responsible for Bangladeshi organizational success (Rahman and Masud, 2011; Alsuhaيمي, 2012; Parul Akhter, 2015). The twelve factors are: Innovation and leadership, employer and employee relationship, rewards and recognition, culture of the organization, Information system, concentration on customer related factor, issues related with ethics, channel of organizational communication, work Team, mutual respect among employees, employee empowerment, continuous improvement.

However, the commonality of concepts of quality and TQM of various researchers are hard to find. Suppose many researchers give emphasis on the "technical and programmatic properties of TQM," whereas another group of researchers pointed out "the general management philosophy." Many other researchers mentioned, "the holistic picture when formulating constructs of TQM (Saraph et al., 1989; Anderson et al., 1994; Flynn et al., 1994; Ahire et al., 1996; Black and Porter 1996; Motwani, 2001; Sila and Ebrahimpour, 2005; Demirbag et al., 2006)". Therefore, on the basis of the above literatures, it is easily concluded that the ideas and opinions of various researchers are not identical rather complementary to each other. And in this research more focused will be given on leadership and top management commitment, focus of customer, process approach, training & development, system approach, continuous improvement, reward and recognition and supplier relationship.

Sustainable Competitive Advantage

Sustainable competitive advantages are company assets, attributes, or abilities that are difficult to duplicate or exceed and provide a superior or favorable long term position over competitors. According to Bohoris (1995)

many organizations have already realized that their only way of surviving in today's competitive global market is to become a successful total quality organization. At the same time, Corbett and Rastrick (2000) stated that there is significant association between TQM activities and organizational competitiveness. Several other researchers support the findings of this study (Shabbir et al, 2010). All these elements associated with sustainability which could achieve through successful quality implementation. According to Fasil and Osada (2011) Total Quality Management is a buzzword for the organizations to safeguard their growth and sustainability in today's strongly competitive and turbulent global scenario.

Currently garments sectors financial performance is satisfactory but to gain the long term sustainability and competitiveness need to focus on TQM practices (Rahman, 2011). According to Zineldin (2006) RMG sector needs to retain its customers by providing excellent quality services with minimum or no defects to gain sustainability. So, the defining role of TQM implementation in predicting to gain sustainable competitive advantage in Bangladesh RMG context is required (Akhter, 2015). According to Pinho (2008) in the global market, for gaining sustainability practices of TQM received proper attention and acknowledgement. Kanji (2001) stated that, "organizations need a framework that is comprehensive, flexible and easy to adopt and help to gain sustainability." According to Talib et al. (2010), "the reasons being only to help industries improved its efficiency and competitiveness through quality improvement." TQM practices enhance the whole organizational communication system which is highly required for quality performance in the current business world (Lee, 2012). Drew and Healy (2006) stated that, "TQM allows firms to obtain a high degree of differentiation, satisfying customer needs and strengthening the brand image, and also acts as a tool to reduce costs by preventing mistakes and time wastage, while it allows improvement in the corporation processes." Sila and Ebrahimpour (2003) also had given emphasis on conducting research on TQM elements in aspect of various countries as well as various industries. For sustainability cost reduction as well as product and service differentiation is required which can be achieved through TQM practices (Sharma & Kodali, 2008).

In this research organizational performance selected as the part of gaining sustainable competitive advantage in Bangladesh RMG sector. According to Li et al. (2006) organizational performance refers to how well an organization achieves its market-oriented goals as well as its financial goals. In this regard, Stock et al. (2010) mentioned that a number of prior studies have measured organizational performance using both financial and market criteria, including return on investment (ROI), market share, profit margin on sales, the growth of ROI, the growth of sales, and the growth of market share. In this research long term performance is focused which is related with organizational long-term sustainability. According to Terziovski (2006) TQM is the source of sustainable competitive advantage for business organizations. Teh et al. (2009) stated that TQM work as a source of enhancing organizational performance through continuous improvement in organization's activities. At the same time, much research had been conducted to define the relationship among TQM and innovation (Prajogo & Brown, 2004). The relation between TQM and innovation also need to be considered in aspect of gaining Bangladesh RMG sectors sustainable competitive advantage which is focused in this study.

The effect of TQM practices on gaining sustainable competitive advantage in context of Bangladesh ready-made garments industry should be select for further research which will done in this research as there is a huge research gap for it. In this Regard, according to Dean and Bowen (2014) the recognition of TQM as a competitive advantage is widespread around the world, especially in Western countries, and today very few companies especially manufacturing companies can afford to ignore the term TQM. Therefore, according to Issac et al. (2014) TQM has been widely considered as management tool for business stability, growth and prosperity as a tool to keep competitive advantage. In this regard, Dale and Plunkett (1995) stated that for last two decades, quality has been considered as one of important factor in manufacturing, service and purchasing to increase sales and profits. There is an inconsistency of research result of these studies and worthy to examine as research gap. According to Lewis et al. (2006) the relationship is not so clear when the TQM concept is divided into different dimensions and those dimensions are evaluated for their separate effect.

PROPOSED FRAMEWORK

According to Li et al. (2012) TQM practices enhance the whole organizational communication system which is highly required for quality performance in the current business world. Recent research proves that Bangladesh RMG sector faces some serious quality issues that have largely influenced the growth rate of this sector (Haque et al., 2011; Ariful, Nasima and Rashed, 2012). Over the last three decades, there has been a growing interest in Total Quality Management (TQM) as a strategy that is capable of offering organizations a competitive advantage (Reinhardt & Gurtner, 2014). Currently RMG's are facing immense global competition (Heras et al. (2012)). TQM is one of the most widely used operation management practices which most of the developed countries already adopted (Jung & Wang, 2006; Johir, Saha & Hassan, 2014). Whereas, According to BGMEA (2014) the quality of products and services of Bangladesh ready-made garments are a vital issue to concern. RMG can charge high prices as well as increase their profit if they can ensure about their quality operation of product and service delivery (Ariful, Nasima, & Rashed, 2012; Yunus & Yamagata, 2012).

Many organizations have already realized that their only way of surviving in today's competitive global market is to become a successful "total quality organization" (Alsuhaime, 2012). Empirically, In the aspect of Bangladesh garments manufacturing industry a TQM approach unique to the needs and culture of the organization must be developed (Rahman & Masud, 2011; Johir, Saha & Hassan, 2014). At the same time, Absar and Mahmood (2012) stated that in the context of TQM, the extent to which HR departments undertake and support organizational sustainability competitive advantage have been examined and seriously questioned. In the current Bangladesh RMG context, HRM researchers paid much attention on TQM practices and implementation in case of organizational profitability (Absar & Mahmood 2012; Parul Akhter 2015. Literatures suggest that, several TQM practices help organization to gain sustainable competitive advantage, specially, developing country like Bangladesh ready-made garments industry(Bansari, N., 2010; Ahamed, F., 2011).Hence, the following framework is put forward (Figure: 1)

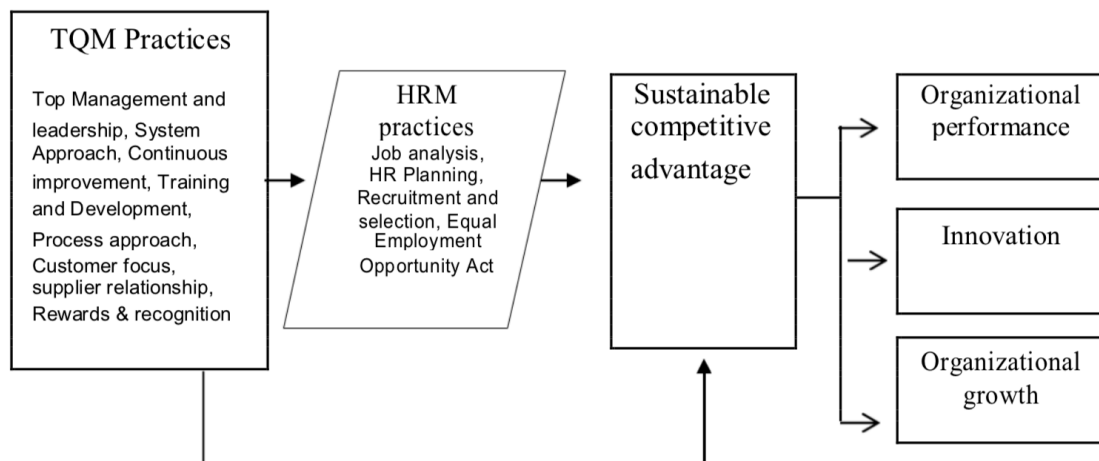

Figure 1: Proposed Research Framework

Based on the Figure 1, HRM practices will influence or alter the value of link among IV and DV. The IV (Independent Variable) is consists of eight TQM practices such as leadership and top management commitment, customer focus, process approach, system approach, training and development, continuous improvement, supplier relationship, reward and recognition. HRM practices work as mediator which consists four practices. The four functions are: Selection and recruitment, job analysis, manpower planning and equal employment opportunity (EEO) will help to build up the efficient workforce. And lastly, the DV (Dependent Variable) is the sustainable competitive advantage which consists of three criterions to measure, such as organizational performance, innovation and organizational growth in the context of Bangladesh Ready-made Garments industry. DV and IV relation or association will be influenced by the levels of mediator, either strong or weak. In few circumstances,

the relation will be either positive or negative depends on the level of mediator. So the impact of mediator will be considerable in aspect of defining the condition of IV and DV.

PROPOSITION TESTING

This part explains how the relationship among variables will be managed and how hypotheses developed and tested. Hypothesis tests, or tests for statistical significance, require a number of elements. Before going further, the proper terminologies such as null and alternative, distribution data, critical value, confidence level, two-tailed or one-tailed test and errors should need to be considered. From the purposed framework, null hypothesis can be generated. A null hypothesis is a claim made, a belief expressed, a statistic is held to be the norm. The proposed framework assigned Human Resources Practices as a mediator variable. Based on the literature reviewed in the previous section, therefore these hypotheses are formulated:

H1: Total Quality Management practices are positively associated with Human Resource Management practices.

H2: Total quality management practices are positively associated with sustainable competitive advantage.

H3: Total quality management practices are negatively associated with sustainable competitive advantage.

H4: Human Resources practices are positively associated with sustainable competitive advantage.

In order to achieve the objectives of the study, according to Creswell (2009), there are mainly three approaches used as the process to collect data and information for the purpose of investigation certain issue; quantitative, qualitative, and mixed method. There is no right or wrong what approach researcher may choose. The important is related with the research paradigm. The research approach selection is based on the research problem. Thus, the research approaches, designs, and the methods represent a perspective about research that presents information in a successive way from broad constructions of research to the narrow procedures of methods (Creswell, 2009).

CONCLUSION

The performance and growth rate of Bangladesh RMG is diminishing. Current research shows various problems associated with the quality issues. However, the performances of Bangladesh RMG sectors are largely influenced by the international quality standard and regulations. By integrating the HRM practices literature into the TQM and organizational sustainable competitive advantage literature, this study do able to scientifically prove the practitioners of RMG sectors that the introduction of TQM is a compulsory step to gain a sustainable competitive advantage. Organizations worldwide have been exploring ways to improve business practices to gain competitive edge. The aim of this study was to test the impact of TQM practices on sustainable competitive advantage at ready-made garments companies in Bangladesh. TQM practices have positive and significant effect toward organizational sustainable competitive advantage. The question whether this proposed framework or model is valid and reliable to be answered if further investigation has been carried out. Henceforth, the examinations of each hypothesis and the subsequent empirical investigations of this study are crucial to validate the proposed research framework. It is expected that the study will be beneficial to local manufacturing players, policy makers, government and relevant practitioners.

References

- Ahamed, F. (2012). Improving Social compliance in Bangladesh's Ready-made Garment Industry. *Journal of Labour and Management in Development*, Vol 13. Retrieved from: <http://www.nla.gov.au/openpublish/index.php/lmd/article/viewFile/2269/3148>
- Akhter, Sharmin. (2014). Deming Management Method in the Readymade Garments Industry of Bangladesh. *Journal of Management*, Vol. 9(1), 178-189.
- Alsuhaimi, M. R. (2012). The Implementation of Total Quality Management in King Saud University. *International Journal of Independent Research and Studies-IJIRS*, Vol. 1(2), 84-88. Ahamed, F.
- (2013). Could monitoring and surveillance be useful to establish social compliance in the ready-made garment (RMG) industry of Bangladesh? *International Journal of Management and Business Studies*, Vol. 3 (3), 088-100.

- Ariful M. I., & Anwarul Haque, A.F.M. (2012). Key aspects of TQM implementation in manufacturing organization- an empirical investigation. *International Journal of Research in Management & Technology (IJRMT)*, ISSN: 2249-9563, Vol. 2 No. 3.
- Alireza Anvari, Yusof Ismail & Seyed Mohammad Hossein Hojjati (2011). A Study on Total Quality Management and Lean Manufacturing: Through Lean Thinking Approach. *World Applied Sciences Journal*, 12 (9): 1585-1596.
- Bangladesh Bureau of Statistics. (2015). Statistical pocket book of Bangladesh. GOB. Dhaka. Government Printing Office.
- BKMEA. (2014). Export Performance of RMG of Bangladesh for 2011-12 and 2012-13. Annual Report of Bangladesh Knitwear Manufacturers and Export Association. Retrieved from <http://www.bkmea.com/facts-figures.html>
- Bangladesh Garment Manufacturers and Exporters Association. (2015). Annual Report of BGMEA. Retrieved from www.bgmea.com
- Calvo-Mora, Picón, A., Ruiz, C., & Cauzo, L. (2014). The Relationships between Soft-Hard TQM Factors and Key Business Results. *International Journal of Operations & Production Management*, Vol.34 (1), 115–143.
- Feng, M., Terziovski, M. & Samson, D. (2007). Relationship of ISO 9001: 2000 Quality System Certification with Operational and Business Performance: A Survey in Australia and New Zealand-based Manufacturing and Service Companies. *Journal of Manufacturing Technology Management*, Vol. 19 (1), 22–37.
- Fasil, T. & Osada, H. (2011). Multiple dimensions of TQM success in developing countries: an empirical study on Deming prize winners from India and Thailand. *International Journal of Innovation and Learning*, Vol. 9(2), 184-203.
- Gopal K Kanji, & Mike Asher (1996). 100 methods for TQM. Response Books, New Delhi. Hietschold, N., Reinhardt, R., & Gurtner, S. (2014). Measuring Critical Success Factors of TQM Implementation Successfully-a Systematic Literature Review. *International Journal of Production Research*. Retrieved from <http://dx.doi.org/10.1080/00207543.2014.918288>
- Harun, N. A., Rashid, A. A., & Alrazi, B. (2013). Measuring the Quality of Sustainability Disclosure among the Malaysian Commercial Banks. *World Applied Sciences Journal*, Vol. 28, 195–201. Ishikawa, K. (1985). *What is TQC. The Japanese way*. Englewood Cliffs, NJ: PrenticeHall.
- Islam, M.M., & Khan, A.M. (2013). Minimization of Reworks in Quality and Productivity Improvement in the Apparel Industry. *International Journal of Engineering and Applied Sciences*, 1(4), 147-165.
- Israfil Shahin Seddiq, & Avizit Basak. (2014). Importance of Human Resource Management and the Competitive Advantage: A Case Analysis on Basis of the Textile Industry of Bangladesh. *Global Journal of Management and Business Research: A Administration and Management*, Vol.14 (9), 93-115.
- Islam, Md. Ariful, & Haque, A.F.M. Anwarul. (2012). Pillars of TQM Implementation in Manufacturing Organization- An Empirical Study. *Journal of Research in International Business and Management*, Vol. 2(5), 128-141.
- Jahid, H. (2013). The Competitiveness of Ready Made Garments Industry of Bangladesh in Post MFA Era: How Does the Industry Behave to Face the Competitive Challenge. *British Journal of Economics, Management & Trade*, Vol. 3(3), 296-306.
- Juran, J.M. (1995). *A history of managing for quality: The evolution, trends and future direction of managing for quality*. Milwaukee, WI: ASQC Quality Press.
- Kim, D., Kumar, V., & Kumar, U. (2012). Relationship between quality management practices and innovation. *Journal of Operations Management*, Vol. 30, 295-315.
- Md. Ariful Islam, & Anwarul Haque, A.F.M. (2012). Key aspects of TQM implementation in manufacturing organization-an empirical investigation. *International Journal of Research in Management & Technology (IJRMT)*, Vol. 2(3), 268.
- Munim Joarder, Nurul Hossain, & M M Hakim. (2010). Post-MFA Performance of Bangladesh Apparel Sector. *International Review of Business Research Papers*, Volume 6(4), 134 – 144.
- Nurul Absar, & Monowar Mahmood (2011). New HRM Practices in the Public and Private Sector Industrial Enterprises of Bangladesh: A Comparative Assessment. *International Review of Business Research Papers*, Vol. 7(2), 118-136.
- Ooi, K. B. (2014). TQM Practices and Knowledge Management: A Multi-group Analysis of Constructs and Structural Invariance between the Manufacturing and Service Sectors. *Total Quality Management & Business Excellence*. doi:10.1080/14783363.2014.914642.
- Parul Akhter (2015). Key Factors of TQM Implementation in the Textile and RMG Industry: A Study of Some Textile and RMG Companies of Bangladesh. *IOSR Journal of Business and Management*, Volume 17(2), 26-37.

- Prajogo, D.I. (2005). The comparative analysis of TQM practices and quality performance between manufacturing and service firms. *International Journal of Service Industry Management*, Vol. 16(3), 217–228.
- Rahman, M. M., & Masud, A.K.M. (2011). Quality Improvement in Garments Industry Through TQM Approach. *International Conference on Mechanical Engineering (ICME2011)* 18-20, Dhaka, Bangladesh, pp.1 -2.
- Rahman, M. M., & Masud, A.K.M. (2011). Quality Improvement in Garments Industry Through TQM Approach. *Proceedings of the International Conference on Mechanical Engineering, ICME 11-RT- 044*.
- Rahman, M. M., & Masud, A. K. M. (2011). Quality Improvement in Garments Industry Through TQM Approaches. *Journal of Management*, Vol. 12(1), 111-119.
- Shah Johir Rayhan, Sajeeb Saha, & Mohammad Masudul Hassan (2014). Factors Affecting the Customer Buying Behavior in Relation to Readymade Garments in Bangladesh. *International Research Journal of Marketing*, Vol. 2(2), 36-42.
- Sila, I., & Ebrahimpour, M. (2003). Examination and Comparison of the Critical Factors of Total Quality Management (TQM) across Countries. *International Journal of Production Research*, Vol. 41 (2), 235–268.
- Sharif Ahmed, Syduzzaman, Mahbubor Rahman, Mazedul Islam, & Ahashan Habib (2014). Effect of Total Quality Management (TQM) on Employee Satisfaction in the Apparel Industries of Dhaka Division. *European Scientific Journal*, Vol. 22(7), 251-269.
- Shahid Mehmood, Faisal Qadeer, & Aftab Ahmad (2014). Relationship between TQM Dimensions and Organizational Performance. *Journal of Commerce and Social Sciences*, Vol. 8 (3), 662-679.
- Sila, I., & Ebrahimpour, M. (2005). Critical linkages among TQM factors and business results, *International Journal of Operations & Production Management*, Vol. 25 (11), 1123- 1155.
- Sadrul Huda, Nargis Akhtar, & Afsana Akhtar (2011). Employee's View on Job Satisfaction: A Study on Garments Industry in Bangladesh. *Indus Journal of Management & Social Sciences*, Vol. 5(1),1-9
- Sukhwinder, Singh. (2013). TQM: An Emerging Necessity for Small Scale Industry Sector. *Global Research analysis*, Vol. 2 (1), 136–137.
- Talib, F., Rahman, Z., & Qureshi, M. N. (2010). The Relationship Between total Quality Management and Quality Performance sin the Service Industry: A Theoretical Model. *International Journal of Business Management and Social Sciences*, Vol. 1(1), 113-128.
- Uddin, Md Abbas. (2012). Readymade Garments Industry of Bangladesh: How the Industry is Affect in Post MFA Period. Unpublished master's thesis, Curtin University of Technology, Perth, Australia.
- Yunus, M., & Yamagata, T. (2012). The Garment Industry in Bangladesh. Fukunishi (Ed.). *Dynamics of the Garment Industry in Low Income Countries: Experience of Asia and Africa (Interim Report)*. Chousaken Kyu, Huokokusho, IDE-JETRO



The Level of Adoption of the International Accounting Standard 34 (IAS 34.) : The Case of Bahrain Listed Companies

Dr. Abdulla A. Rahman Ali¹

¹ Assistant Professor, University of Bahrain, College of Business Administration, Department of Accounting, Kingdom of Bahrain. Email: Mohanad52@hotmail.com

Abstract

The purpose of this study to explore the level of adoption of the International Accounting Standard 34 (IAS 34) in the preparation of interim reports by listed companies on Bahrain Stock Exchange (BSE). The data used in this exploratory study were based largely on information already published in the interim financial reports that are available at Bahrain Stock Exchange and on the websites of the listed companies. Neither IAS 34, nor does the national accounting legislation in Bahrain require firms to prepare interim financial statements . However, as elsewhere around the globe, companies in Bahrain prepare interim financial reports in compliance with the IAS 34. Not least because it is required for a company to be listed on Bahrain Stock Exchange (BSE). In addition, in order to maintain investor confidence, listed companies often exert considerable effort to disclose all necessary information that shows their financial position and ability to continue as a going concern through preparing more timely, costly interim reports. The results of this exploration reveal that the listed companies actually comply with the requirements of IAS 34, regardless of the high cost involved.

Keywords: International Accounting Standard 34 (IAS, 34) Bahrain Stock Exchange (BSE), Interim Financial Report

Introduction

The function of accounting is to provide pertinent, reliable, and timely financial information for decision making by various users, including investors, creditors and government authorities. The information is often provided through annual financial statements (the balance sheet that shows the financial position of a firm at specific date (what it owns and what it owes), statement of income that shows the results of operation during a period, and statement of cash flows to provide information on cash position, which is difficult to obtain from the statement of financial position.

The financial statements are usually prepared on annual basis. However, in the current volatile and dynamic business environment, the demand for more frequent, up- to-date reporting has gained an increasing momentum. It is now widely claimed that annual reporting is not enough to assess the ever changing business environment. Indeed, in the US as early as 1933 -1934, the Securities and Exchange Commission (SEC), required listed

companies planning to issue securities on the stock exchange to provide up to date information for users both annual and interim. SEC requires that Form 10 Q, to be filed quarterly and form 10 K to be issued annually at year end. Equally Securities and Exchange Board of India (SEBI) issued guidelines on February 4, 2000, requiring the stock exchanges to amend their listing agreements requiring each company to furnish unaudited financial result on a quarterly basis. The SEBI further required each listed company to submit quarterly compliance report on corporate governance.

In effect, the need for frequent reporting has long been recognized, but only in June 1999, that IAS 34 was first issued, and amended in 2010, 2012, 2014.

An interim financial report is either complete or condensed set of financial statements that normally covers a period of less than a year, semiannual, quarter, or a month (IAS 34-4). According to (IAS 34.8 the statement has to be in a condensed form, which means that only headings and subtotals used in last annual financial statements are required (IAS 34.10), The statements often include statement of financial position, statement of comprehensive income, statement of cash flows, results of operations, statement of changes in equity, and selected explanatory notes. However, IAS 34 does not specify which entities must publish an interim financial report.

In Bahrain, the Commercial Companies Act (CCA- 1975), requires all limited liability companies to provide annual audited financial statements, (income statement, balance sheet, and Board of Directors' report on distribution of dividends). The CCA, 1975, does not require limited liabilities companies to follow a specific set of accounting standards. However, in 1993, the Ministry of Commerce and Agriculture advised the limited liabilities limited liabilities corporate companies to adopt IASs.

The Bahrain Stock Exchange (BSE), was established in 1987, but operations started only on 17 June 1989, with 28 listed companies. The Bahrain Stock Exchange (BSE), is an independent separate legal entity supervised by a Board of Directors, chaired by the Governor of the Central Bank of Bahrain. In 2010, the authorities issued a law to establish Bahrain Bourse (BHB) as a corporation under the 1975 Commercial Companies Act (CCA- 1975).m In 2017, the number of listed companies on the Bahrain Stock Exchange (Bahrain Bourse). Increased to 42. At present, there are 50 companies listed with a market capitalization of \$ 25.3 billion and 5 overseas listings. The Bahrain Bourse is currently a member of various regional and foreign organizations to enhance its operations, such as the Union of Arab Stock Exchanges, the Federation of Euro-Asian Stock Exchanges, the World Federation of Exchanges, the Africa & Middle East Depositories Association, and the Association of National Numbering Agencies.

As of 2015 foreigners are allowed to buy, own or sell bonds, units of mutual funds, and warrants of domestic joint-stock companies. Expatriates living in Bahrain are allowed to purchase, own, and/or trade up to 49% of a domestic joint-stock company's equities. However, an expatriate is not allowed to own more than 1% of a company's issued capital.

There are ten companies that are completely open to foreign investors: Arab Banking Corporation (ABC), Arab Insurance Group (ARIG), Ahli United Bank (AUB), Al Baraka Banking Group (BARKA), Bahrain Middle East Bank (BMB), Ithmaar Bank (ITHMR), Investcorp Bank (INVCORP), Bahrain Shamil Bank (SHAMIL), Al Salam Bank (SALAM), and TAIB Bank (TAIB).

Foreign security holders are legally entitled to reap all the benefits of the ownership of securities of domestic joint-stock companies. They have voting rights on all matters submitted for approval, and receive dividends and other distributions tax free. The sale and purchase of a security creates a binding contract on the part of the seller to deliver

Over the last two decades listed companies on Bahrain Stock Exchange almost doubled from 27 in 2,000 to 50 in 2018 with a market capitalization of more than \$ 53 billion and 5 overseas listings.

Literature Review

Literature survey reveals that very few number of studies were carried out on interim financial reporting in developing countries (Joshi and Bremser, 2003); Omar and Simon, 2011). This clearly indicates that interim financial reporting has not received the necessary attention in the developing world including Bahrain in the contrast to the enorous attention in Europe and the US.

Joshi and Bremser, (2003). suggest that the size of a company in the developing countries is a driving force to adopt IAS 34), and further claim that their findings could be generalized to other developing countries. Equally, other studies suggest that overall disclosure in interim reports is directly related to the size of the reporting firms (Rahman *et al.*, 2007; Schadewitz, 2010; Spasic and Dencic- Mihajlov, 2014). Further, Omar and Simon (2011) found that companies listed in Amman Stock Exchange (Jordan) age, and industry type, along with a few other variables, are factors determine disclosure in interim reports.

IFRS, however, does not require the preparation of interim financial statements. Paragraph 36 in IAS 1 Presentation of Financial Statements only requires that:

'An entity shall present a complete set of financial (including comparative information at least annually.'

Nonetheless, it must be stressed that interim reports are by no means designed to provide reasonable assurance or reliable financial information as compared to the annual reports. Not least because of the shortness of the time period, not audited financial information, and that interim financial reports are subject to management manipulation. Furthermore, the variation between seasons of some businesses, the allocations of cost and expenses among interim periods, may render the benefits of unaudited interim financial statements to be limited.

IAS 34 does not specify the entities that are required to publish interim financial statements, the frequency of interim reports, nor the length of time required to be released after each reporting date. However, the standard encourages, publicly-traded entities to provide interim financial reports

"at least as of the end of the first half of their financial year, no later than 60 days after the interim reporting date".

Accounting Standards (AS-25), on the other hand, assert that ‘

"Timely and reliable interim financial reporting improves the ability of investors, creditors and others to understand an enterprise's capacity, to generate earnings and cash flows, its financial condition and liquidity."

An interim financial report may contain either a complete or condensed set of financial statements for a period less than a year. IAS 34.8 defines condensed to include only headings and subtotals used in last annual financial statements are required (IAS 34.10).,According to IAS 34 the minimum content requirement for the interim financial report is a condensed balance sheet, condensed income statement, condensed cash flow statement, condensed statements showing changes in equity, and selected explanatory notes. IAS 34 also requires an enterprise to apply the same accounting policies in its interim financial report as are applied in its annual financial statements. The accounting policy changes subsequent to the date of the most recent annual financial statements that will be reflected only in the next annual financial statements. The frequency of an enterprise's reporting annual, semiannually, or quarterly should not affect the measurement of its annual results. To achieve that objective, measurements for interim reporting purposes are made on a year-to-date basis, w3hich poses a serious challenge for practitioners, in particular in dynamic economy.

FASB summarized the following objectives and uses for interim reporting to:

1. *estimate annual earnings.*
2. *make projections.*
3. *identify turning points.*
4. *evaluate management performance.*
5. *supplement the annual report.*

Nevertheless, despite its well-recognized advantages, interim reporting faces serious drawbacks.

1. Inventory Problems

For a commercial enterprise, inventory is a major current asset that directly affect working capital and generation of income. Interim reporting faces three different inventory problems, namely: quantity of inventory, valuation of inventories, and adjustments of valuation. Determination of inventory quantity depends largely on physical counts. However, physical counts are often taken on annual basis. Not least, because physical inventory counts are time consuming, daunting business. which hinders inventory count quarterly or monthly prohibitive Inventory valuation, on the other hand, depends on inventory flow assumption. Various inventory valuation methods are accepted by both GAAP and IFRS, namely FIFO, LIFO, average, and specific identification. However, each of these methods produces different inventory value, different cost of goods sold and consequently different income figure. Further, the use LIFO during inflationary periods often poses serious problems in particular in developing countries.

2. Matching Problem

There are two accounting bases, accrual and cash bases. Both GAAP and IFRS prefer the accrual basis of accounting rather than the cash basis. Under the accrual basis, cash receipts from customers do not necessarily occur in the same period in which a firm recognizes revenues. Equally, cash payments to employees, suppliers, and governments do not necessarily occur in the same period in which expenses are incurred. Because of this time lag between cost and revenues, matching of costs and revenues becomes a daunting task. Moreover , certain adjustments, such as accrued payroll, prepaid items, depreciation management bonuses or income taxes are often determined at the end of a fiscal year. Accordingly, such vital adjustments are often not performed in interim reports.

In general, it is important that in assessing firm's results of operations and financial position, the analyst has to take into consideration that interim reports are far less reliable than annual data. Also, interim financial reports are subject to management manipulation.

3. Disclosure Problem

According to both GAAP and IFRS, companies listed on the stock exchange are required to include full disclosures of all useful, relevant and reliable information in their annual financial statements. IFRS 8 requires an entity to:

“disclose information to enable users of its financial statements to evaluate the nature and financial effects of the business activities in which it engages and the economic environments in which it operates” (IFRS 8, para 1).

Interim reports, on the other hand, do not require mandatory interim disclosure. In effect, the interim reporting practices are likely to vary across companies. In addition, the question of determining materiality in order to decide the nature and amount of disclosure poses yet a serious problem. not least, because Measurements for interim reporting purposes should be made on a year-to-date basis, so that the frequency of the entity's reporting does not affect the measurement of its annual results. [IAS 34.28]. indeed, IAS 34.26, requires change in estimates during interim year the nature and amount of that change must be disclosed in the notes to the annual financial statements.

External Audit

In Bahrain, as elsewhere, the Commercial Companies Act (CCA) 1975, requires that annual reports must be audited by an external auditor to add credibility, verify reliability of the financial information and assess that appropriate accounting practices are in place. Interim reports, on the other hand, are based on internal verification, normally by internal auditors. In effect, they are not audited by an independent auditor, which render the value of information less reliable and less credible internal reports.

Further, IAS 34 does not specify which entities must publish an interim financial report. That is generally a matter for local laws and government regulations. The IAS 34, requires the interim report include condensed current period financial statements and comparative information for previous period, namely statement of financial position, statement of comprehensive income, statement of cash flows, statement of changes in equity, and selected explanatory notes.

In addition, IAS 34 requires companies to apply the same accounting policies in the interim report as used in in the annual report, and that full disclosures are required when there are changes in accounting policy. Assets and liabilities are reported and measured for interim reporting purposes on the basis of information available on a year-to-date basis. Although both annual and interim financial statements are based on reasonable estimates, however, the preparation of interim financial reports often requires a greater use of estimation methods than annual financial statements, which hinders their usefulness.

METHODOLOGY

The data used in this exploratory study was based largely on information published in interim financial reports that are available at Bahrain Stock Exchange and on the websites of the listed companies.

Analyses of Results

Financial statements provide a summary of all the financial activities of an entity during specific period. These statements are used to evaluate the results of operations of a business entity (income statement), the financial position (balance sheet) and the cash position. According to the Commercial Companies Act (CCA) 1975, all companies are required to prepare annual financial statements. However, due to the ever changing business environment following globalization, the demand for more timely, detailed interim financial information gained an increasing momentum.

Interim financial reporting involves frequent financial statements throughout the year (monthly, quarterly or semiannual). These statements are often used by external users, mainly creditors and investors or internally by business executives. These reports, although unaudited and often based on estimates, are a useful tool to predict future performance to facilitate more informed business decisions. In addition, interim reports may reveal significant information concerning changes affecting the business and seasonality effects, both of which annual reports could conceal. However, there are certain inherent limitations to interim reporting as a result of their condensed time period. Also interim reports cannot account for fluctuations in revenue, temporary market conditions, or limited disclosures.

This study was carried out to determine the extent of adoption of IAS 34, by listed Bahraini companies. The study reveal that in the first year of the implementation date, more than 75 % of the listed companies had adopted IAS 34. At present, there are 50 companies listed on Bahrain Stock Exchange all adopting IAS 34, and all unanimously prepare interim reports in compliance with requirements of IAS 34.1. All the companies that prepared interim reporting in the early years in Bahrain prepared income statements, balance sheets and cash flow statements, indicating a high degree of compliance to IAS 34. Moreover, all firms published their interim reports on their websites. Companies prepared interim reports for various reasons namely, for a management control, to maintain investor confidence and satisfy listing requirements. The majority of respondents stressed that interim reports are highly relevant for their firms. Further, it has been claimed that interim reports improved performance. A good example is possibly Investcorp (a leading global provider and manager of alternative investment products). On February 5, 2019, management of Investcorp asserted that.

“Despite the challenging macroeconomic environment, the Firm’s net income for the period was \$58 million, up 5% compared to \$55 million for the six months ended December 31, 2017 (H1 FY18). On a fully diluted basis, earnings per ordinary share were \$0.74 for H1 FY19, up 6% from \$0.70 for H1 FY18. Investcorp attributes its resilient performance to the Firm’s continued focus on delivering the strategic objectives”.

Further, consistent with the requirements of IAS 34.11, all companies listed on Bahrain Stock Exchange present basic and diluted earnings per share (EPS) for the interim period. However, the respondents were not on voice regarding the cost of compliance to IAS 34, expensive or not.

Summary and Conclusion

Regardless of its serious limitations outlined earlier, interim financial reports are now sweeping across all industries worldwide. At present, companies listed on the Bahrain Stock Exchange (BSE) unanimously prepare interim financial reports in compliance with IAS 34, regardless of cost. Not least because, compliance is required by the listing requirements, listed companies are often keen to boost investor confidence, and interim financial reports are often used as a management control tool. Nevertheless, the fact that these reports are reviewed rather than audited by an independent auditor, render their level of assurance moderate and reliability limited. Further, seasonal business variation affect their predictive ability, whole the possibility of management manipulation hinders their usefulness.

This study concludes that all companies listed on the Bahrain Stock Exchange (BSE) prepare interim reports in compliance with IAS 34. Moreover, they use the same accounting policies in the interim report as used in the annual report, and provide full disclosures whenever there are changes in the accounting policy. This is consistent with earlier studies. (Joshi and Bremser, 2003;) Omar and Simon, 2011; Bayoud *et al.*, 2012; Elzahar and Hussainey, 2012; Al-Hamadeen and Badran, 2014; Spasic and Dencic-Mihajlov, 2014).

References

- Abdel-Khalik, A. R., & Espejot, J. (1978). Expectations Data and the Predictive Value of Interim Reporting. *Journal of Accounting Research*. 16 (1). 1-13.
- Al-Hamadeen, R. & Badran, S. (2014), "Nature and Determinants of CSR Disclosure: Experience of the Jordanian Public Shareholding Companies," *European Journal of Business and Management*, 6 (13), 18-34.
- Alsharairi, M. & Al-Abdullah, R. (2008). *The Impact of Adopting International Accounting Standards on the Jordanian Environment: The Perspective of Accountants, Auditors and Academicians*. International Conference on Business Globalization: Challenges and Opportunities in the 21st Century.
- Bayoud, N. S., Kavanagh, M., & Slaughter, G. (2012), "Factors Influencing Levels of Corporate Social Responsibility Disclosure by Libyan Firms: A Mixed Study." *International Journal of Economics and Finance*, 4(4),
- Brown, L. D., & Rozeff, M. S. (1979). The Predictive Value of Interim Reports for Improving Forecasts of Future Quarterly Earnings. *The Accounting Review*. 54 (3). 585-591.
- Butler, M., Kraft, A., & Weiss, I. S. (2007). The Effect of Reporting Frequency on the Timeliness of Earnings: The Cases of Voluntary and Mandatory Interim Reports. *Journal of Accounting and Economics*. 43 (2-3). 181-217.
- Chua, W. F. (1986). Radical Developments in Accounting Thought. *The Accounting Review*. 61 (4). 601-632.
- Elzahar, H., & Hussainey, K. (2012). Determinants of Narrative Risk Disclosures in UK Interim Reports. *The Journal of Risk Finance*. 13 (2). 133 -
- Hossain, M., & Hammami, H. (2009). Voluntary Disclosure in the Annual Reports of an Emerging Country: The Case of Qatar. *Advances in Accounting, Incorporating International Advances in Accounting*, 25(2), 225-
- Juhmani, O. (2012). Ownership Structure and Corporate Voluntary Disclosure: Evidence from Bahrain. *International Journal of Accounting and Financial Reporting*, 3(2), 133-148.
- Juhmani, O. (2012). Ownership Structure and Corporate Voluntary Disclosure: Evidence from Bahrain. *International Journal of Accounting and Financial Reporting*, 3(2), 133-148.
- Joshi, P.L., Al-Mudhahki, J. (2013). Empirical Study of Compliance with International Accounting Standards (IAS-1) by Stock Exchange Listed Companies in Bahrain. *Journal of Financial Management and Analysis*, 26(2),
- Joshi, P.L., Ramadhan, S. (2002). The adoption of international accounting standards by small and closely held companies: evidence from Bahrain. *The International Journal of Accounting*, 37(4), 429-440.
- Joshi, P. L., & Bremser, W. G. (2003). Interim Reporting Practices by Companies in Bahrain: Preparation of Interim Accounts and Early Adoption of IAS 34. *Advances in International Accounting*. 16. 105-122.

- KPMG. (2014). Guide to Condensed Interim Financial Statements -Disclosure checklist. KPMG.
- Krippendorff, K. (2004). *Content Analysis: An Introduction to Its Methodology*. USA: Sage Publications.
- Malek Alsharairi, Radhi Al-Hamadeen, Frances Issa, Oday Kakish “Interim Financial Reporting and Compliance with IAS 34: The Case of the Jordanian Financial Sector” *International Journal of Business and Social Science Vol. 6, No. 11; November 2015*.
- Mangena, M. (2004). *On the Perceived Importance of Disclosure Items in UK Interim Financial Reports: Evidence from the Investment Analysts*. Working paper series, Bradford University, England.
- Mangena, M., Kinman, R., & Citron, D. (2007). Investment Analysts’ Perception of Disclosure in UK Interim, Financial Reports. *Journal of Applied Accounting Research*. 8 (3). 146-185. 20.
- Nieuwoudt, M. J. (1998). Interim Financial Reporting - Compliance to Local Statutory Requirements, Local Regulatory Requirements and Local and International Accounting Standards. *Meditari Accountancy Research*. 6. 241
- Omar, B., & Simon, J. (2011). Corporate Aggregate Disclosure Practices in Jordan. *Advances in Accounting*. 27 (1). 166-186.
- Opong, K. K. (1988). *The Information Content of Interim Financial Reports – U.K. Evidence*. University of Glasgow, Scotland.
- Rahman, A. R., Tay, T. M., Ong, B. T., & Cai, S. (2007). Quarterly Reporting in a Voluntary Disclosure Environment: Its Benefits, Drawbacks and Determinants. *The International Journal of Accounting*. 42 (4). 416-442.
- Ryan, B., Scapens, R., and Theobald, M. (2002), *Research Method & Methodology in Finance & Accounting*, Thomson, London.
- Schadewitz, (2010). *Financial and Nonfinancial Information in Interim Finland Determinants and Implications*. Aalto University School of Economics, Finland.
- Securities and Exchange Board of India (SEBI), [HTTP// SEBI.gov.in](http://SEBI.gov.in)

Appendix**Companies Listed on the BSE**

Sector	Number	Apply IAS 34
Commercial banks sector	7	Yes
Investment sector	14	Yes
Insurance sector	6	Yes
Services sector	8	Yes
Industrial sector	3	Yes
Hotels & tourism sector	6	Yes
Overseas companies	5	Yes

Commercial banks sector

Stock symbol	Company
AUB	Al-Ahli United Bank
AUB.PREF.A	AUB Class A Preference Share
SALAM	Al Salam Bank
BISB	Bahrain Islamic Bank
BBK	<u>Bank of Bahrain and Kuwait</u>
NBB	National Bank of Bahrain
BSB	The Bahraini Saudi Bank

Services sector

Stock symbol	Company
BASREC	Bahrain Ship Repairing & Engineering Company
CPARK	Bahrain Car Park Company
CINEMA	Bahrain Cinema Company
DUTYF	Bahrain Duty Free Shop Complex
BMMI	Bahrain Maritime & Mercantile International
BATELCO	Bahrain Telecommunications
TRAFCO	General Trading & Food Processing Company
Nass	Nass Corporation

Insurance sector

Stock symbol	Company
BKIC	Bahrain & Kuwait Insurance Company
AHLIA	Al-Ahlia Insurance Company
AIIC	Arab International Insurance Company
TAKAFUL	Takaful International Company
ARIG	Arab Insurance Group
BNH	Bahrain National Holding Company

Investment sector

Stock symbol	Company
BARKA	Al Baraka Banking Group
INOVEST	Inovent
ABC	Arab Banking Corporation
BCFC	Bahrain Commercial Facilities
BMB	Bahrain Middle East Bank
ESTERAD	Esterad Investment Company
GFH	Gulf Finance House
GMG	Gulf Monetary Group
INVCORP	Investcorp Bank
ITHMR	Ithmaar Bank
TAIB	TAIB Bank
UGB	United Gulf Bank
UGIC	United Gulf Industries Corporation
SICO-C	Securities and Investment Company

Industrial sector

Stock symbol	Company
ALBH	Aluminium Bahrain
BFM	Bahrain Flour Mills Company
POLTRY	Delmon Poultry Company

Hotels & tourism sector

Stock symbol	Company
FAMILY	Bahrain Family Leisure Company
BHOTEL	Bahrain Hotels Company
BTC	Bahrain <u>Tourism</u> Company
SEEF	Seef Properties B.S.C.
BANADER	Banader Hotels Company
NHOTEL	National Hotels Company

Overseas companies

Stock symbol	Company
BMUSC	Bank Muscat
GLOBAL	Global Investment House
SIIG	International Investment Group
SDTL	<u>Sudan Telecommunications Company</u>
UFC	United Finance Company



Emerging Technologies in Management Accounting

Bruce H. Geddes, Ph.D.¹

¹Keiser University, US. Email: drbrucegeddes@gmail.com

Abstract

This paper gives a broad overview of emerging technology fields and their effect on management accounting. The research involved reviewing, describing, analyzing, and summarizing some of the literature in the area. The first field examined was that of business intelligence (BI) and its necessary partnership with management accounting. Following the BI section is an examination of how software aids accounting analytics. Next up is the surging field of big data and how it is poised to revolutionize the accounting profession. Included in this area are the definitions of descriptive, predictive, and prescriptive analytics. The study found that many of the emerging technologies required more research at a rapid pace because of the importance that management accountants play in the success of organizations. An additional area impacted is accounting education because of the need for business schools to turn out graduates with the necessary skills to meet the needs of a changing accounting profession.

Keywords: Emerging Technologies, Management Accounting, Accounting

Accounting is the most vital part of the information system (Andrei et al., 2018). Managerial Accounting (MA) has evolved from the traditional costing information of providing relevant information for managers to newer guidelines of Activity Based Costing and the Balanced Scorecard approach creating added value (Hint et al., 2018). Managerial accounting is the first source of information, permitting corroborating decisions to accomplish stationary goals (Andrei et al., 2018). With the onset of globalization, managerial accounting has adapted to new circumstances by changing the role and expanding utility for management (Vultur, 2018).

Expanding Role of Managerial Accounting

Accounting is a social science because it meets the criteria of it having a terminology, a study object, methodology, and laws. And because managerial accounting can provide answers to questions about costs, the contribution amounts of goods and activity, it has won the informational conflict with financial accounting. Managerial accounting includes aspects necessary to provide information to managers about processes, operations of an organization, elements needed to make decisions and possible backlash of said decisions, and those elements required to administer control in a perennial and efficient manner (Andrei et al., 2018).

Traditional accounting systems have been replaced with forward-looking and forward-thinking advanced systems focusing on efficiency and effectiveness. Managerial accounting now has the role of driving, influencing decisions, and identifying new strategies. With such innovations as Life Cycle Costing and Strategic Managerial Accounting, the focus of MA is on creating measurable value (Hint et al., 2018). Using internal information to put forth business solutions makes managerial accounting a vital management tool regardless of the degree delegation of responsibilities (Andrei et al., 2018).

Increased competition has led to the revamping of organizations' internal processes and pointing to management accounting's essential place in producing better knowledge of costs, sales prices, forecasting, and the necessary tools for a company's success. Because of the continuous changes of economies, processes, the firm's activities, the production, and distribution of products requiring constant retooling and development of management techniques have led to continued research in management accounting (Nicoletta, 2019).

The role of the accountant has changed from a number cruncher to a trusted business partner and advisor. In every company, MA is an unequalled judge of past events, the crucial guide to the present, and the fundamental advisor for the future. In the current global economy, MA is an up to date path and a realistic choice for business leaders. MA allows business leaders to handle complex problems in a complex environment. And the management accountant's role is to know the costs and aid in shaping the managers' decisions by adapting to their tools and practices to meet the demands of the decision-makers (Nicoletta, 2019).

Kose & Agdeniz (2019) noted the function of MA is to provide upper management with vital information as a part of the accounting process. And the role of MA has changed to providing information for strategic decisions, solve complex problems, and the integration of methods used in decision making. Knowledge is a source of competitive advantage, and MA is at the center of defining, collecting, measuring, and analyzing data.

Kose & Agdeniz (2019) reported the institute of Management Accountant's revision of the MA Competency Framework. The definition of the competencies is:

Strategic Management: Leading the future of strategic planning, decision making, and performance monitoring.

Reporting and Control: Standardized measuring and reporting of performance.

Technology and analytics: Manage technology and analyze data.

Business acumen and operations: Contribution of a cross-functional business partner for company-wide operations.

Leadership: Inspirational team leadership to accomplish goals.

Professional ethics and values: Demonstration of ethics, professionalism, and legal compliance to sustain a business model.

In a global business economy, to be more effective in cost identification, increased productivity leading to more substantial profits, a firm must become familiar with MA tools (Kabir, 2019)

Business Intelligence

Business intelligence (BI) are technological tools used to gather, store, access, and analyze data to aid businesses to make informed decisions. Companies use BI to become more competitive by adapting quickly to customer demands and changes in their operating environment. Although many of the attributes of BI are intangible, a business should not discard its importance (Moreno et al., 2019).

The data revolution has caused a refinement and a change in the management accountant's careers and job descriptions. Accountants will be free from robotic tasks such as billing, management reports, and organizing financial data to evaluating, analyzing, and interpreting it. The leadership of an organization will expect to be more connected with the management accountant as they will have more time to analyze trends and create insight (Lawson, 2019).

Since business intelligence and analytics (BI&A) incorporate data collection for supporting decision making and management accounting is a decision-supporting activity, there is a clear link. Therefore, the integration of the two is necessary. There are four technological aspects BI&A (1) infrastructure, which is cloud-based (2) data management (internal and external data synchronization) (3) data analysis including artificial intelligence and statistical techniques (4) information delivery. There is an integration of these aspects because you can't have one without the other, referred to as the "technology stack" of BI&A. The foundational purpose of these is to gather, process, and analyze data to improve the manager's decision making (Rikhardsson & Yigitbasioglu, 2018).

BI can aid in today's global economy of needing real-time accounting data. Real-time accounting offers a multitude of benefits over traditional methods of reporting. Higher competition requires more current information allowing managers to make needed decisions in a fast-paced business environment. Recognized among several real-time reporting technologies, BI allows the creation and disseminating of more focused and relevant data to managers empowering long-term goal planning and optimization of the daily business process by the organization (Trigo et al., 2014).

There has been an elevation of interest in BI for accounting. Highly efficient BI systems are synonymous with the implementation of performance measurement system design. However, the usefulness of BI is only practical if the organization is laser-focused with concrete procedures and is not subject to improvisation. If managers make decisions not grounded in facts and data, but from spontaneous competencies, then BI is less effective (Peters et al., 2018).

Accounting Analytics

Business analytics (BA) is using computer software to garner insight from data to make a better business decision instead of leaving things up to a standardized process. BA applies a set of technologies and methods to use data to comprehend and analyze business data. The makeup of BA is (1) predictive analytics – what could happen now or later, is there a recognizable pattern? Predictive analytics consists of large-scale data usage to highlight analytical and predictive business model performance, (2) Prescriptive analytics – the approach of optimization in two areas, addressing the best outcome, and its achievement (Nielsen, 2018). (3) Descriptive analytics – answers the question of what happened; it is the most common analytics type used by firms today and contains descriptive statistics (Appelbaum et al., 2017).

Acito & Khatri (2014) pointed out BA addresses significant issues such as financial statement effect, stock prices, the cost of capital, and the precarious balance between management behavior and shareholder interest. A synthesis of knowledge gained from BA to apply to management accounting is (1) the focus of management accountants must be on a comprehensive view in an analysis culture (2) MA must be concerned with decision-based in facts having an impact on value (3) MA must be focused on predictions and forecast (4) MA must focus on visualized reporting and presenting the information in an understandable, exciting and useful way (5) management accountants must have the skillset for MA (Nielsen, 2018).

MA can use prescriptive analytics to reinforce decisions made about uncertainties. MA must infringe on the management accountants and non-accountants to solve problems unapologetically. MA has lengthened its traditional focus to include identifying financial performance drivers and new non-financial metrics. Trends occurring in MA now are (1) no longer focusing on customer profitability and product channel (2) MA explaining role in the organization (3) the shift of predictive accounting (4) BA entrenched in enterprise performance management (5) synchronized and improved MA methods (6) recognizing information technology and sharing of services is a business (7) improved MA skills (Appelbaum et al., 2017).

Big Data

Big data is in just about every element of organizations today. For example, a business may create, purchase, extract, administer, release, retrieve, and analyze millions of data elements from within or outside of the company (Appelbaum et al., 2017). The description of Big data is (1) volume – the total amount of data stored, (2) velocity – creation intensity for new data (3) variety – the assortment of data and its byproduct (Huttunen et al., 2019). Big data will bring extraordinary benefits and gains to individuals and companies by reducing data storage costs and making enormous volumes of data available in real-time, allowing organizations to make relevant and cost-conscious decisions (La Torre et al., 2018).

Big data has structured and unstructured data. Structured data has a pattern of well-defined information, and unstructured data is streaming free information. Obtaining value from big data, structured and unstructured data must be combined so that analysis can take place. The analytics of big data is advanced. The advanced processes

allow for large volumes of data to be processed. Utilizing advanced techniques of analysis includes text, audio, video, social media. The analysis leads to descriptive, diagnostic, or predictive analytics ((Huttunen et al., 2019).

The analysis of big data is quantitative, which entails testing training and scoring models. Several techniques are applied, such as data mining, semantic analysis, data visualization, data discovery, and geospatial analysis. Additionally, analyzed are email, tweets, and transaction analysis by text mining. Big data analysis involves software for data visualization such as Hadoop, NoSQL, and Tableau. The software empowers predictive analytics since it is the most popular form of analytics used (Dewu & Barghathi, 2019).

Discussion

Business Intelligence

Business Intelligence is in its infancy. There are still businesses that do not know what to do with it or how to use it. BI systems should not be embarked on merely because other companies are doing the same. However, firms must diligently analyze what their need is in terms of these systems and what benefits may lie ahead for them (Tamandeh, S. (2016).

BI is used to administer the flow and holdings of business information inside of a company. BI helps convert massive amounts of data into pure knowledge for the organization's managers. BI's main application is the assistance in firm decision making, therefore using the system's structural and non-structural data is the basis for BI (Tamandeh, S. (2016).

BI represents a shift in data analysis done by management accountants. Management accountants no longer must use the IT department for data analysis because of the ease of predictive analysis. Predictive analysis utilizes the BI power of big data, so basing the review on historical data is not used. Focusing on its four characteristics, (1) prediction (2) rapid analysis (3) relevant business analysis, and (4) user-friendly tools, BI takes on the need for real-time analysis head-on and links it to informed decision making (Brands, 2014).

Accounting Analytics

Management accountants can use data analytics to aid organizations to interpret data. Interpretation is made by:

- Determine the best metric to track - use data analysis to develop goals on the use of data.
- Ensure "clean" data – make sure the information received is accurate and relevant.
- Utilize the functionality of available tools – analyze the system thoroughly and use all elements completely.
- Don't let new terms like 'Big Data' scare you – data does not have to be analyzed and utilized by a data center (Amato, 2016).

Management accountants will need to learn an entirely new skill set in the area of analytics to be successful. They must be able to successfully excerpt and review the immense amount of data they are privy to while familiarizing themselves with the most modern methods of data governance, query, analytics, and visualization. Linking knowledge of technology with strategic and leadership skills will allow management accounting professionals to break-down and relay the story the data is telling (Lawson, 2019).

Using analytics directed at big data, accountants can widen their monitoring techniques to include unstructured data that may lead to the identification of improvement areas. Organizations will need to develop new procedures with the ability to continuously monitor, analyze, and decipher data. Accountants, because of their unique training and skills, can utilize these skills to examine the effect this has on performance measures and how it aligns with the firm's strategic objectives. Management accountants will see their roles grow within the organization because of their ability to interject their business knowledge into the mining of structured and unstructured data (Richins et al., 2017).

Big Data

The most meaningful thing about big data is there is now a more significant variety of data, including externally generated data from websites, email, and texts. However, expansion of service is nothing new to the modern-day accountant. Accountants have a history of responsibility expansion when it comes to organizational improvement (Janvrin & Weidenmier, 2017).

The management accountant's focus has changed because of big data. Businesses invest heavily in the ability to collect, process, prepare, and analyze data, and they expect their management accountants to possess a deep, clear understanding of the data. This data needs to be of high quality. High-quality data is complete, precise, valid, accurate, relevant, and timely. Most businesses view this data as an asset that impacts the firm's bottom line tremendously. If the data is of poor quality, it will harm the management accountant because it may cause errors in the forecasting. To be good at data analysis, the management accountant needs excellent data. (Appelbaum et al., 2017).

Big data contains massive data sets that traditional database management systems cannot analyze. The majority of big data, 90%, is unstructured and contains information considered soft data such as email, social media postings, phone calls, website visits, and streamed videos. Big data can aid as long as there is a conversion of storage units of big data into actionable information. This creates a specialization where a data analyst/scientist flourish. For management accountants to use big data, these specialists must comprehend, identify, convert, and analyze the data (Warren et al., 2015).

Because management accountants have access to more data and better ways to analyze this data, systems that incorporate this additional data can use descriptive, predictive and prescriptive analytics to answer the questions of what has happened, what will happen, and what is the best solution moving forward (Appelbaum et al., 2017). Big data may speed up the merging of U.S. GAAP and IFRS, developing a global system with accounting as the lynchpin. Big data is a technological advancement that is poised to change the processing of financial transactions and usher in new forms of documentation to support management accounting (Warren et al., 2015).

Future Impact

There is no doubt managerial accounting is changing in the next few years. Managerial accounting spotlights the future and what will happen (Ioana et al., 2019). Managerial accounting has evolved from traditional costing information to new guidelines (Hint et al., 2018). With the advent of big data and data analytics, management accounting will be the center of information for decision making in an organization. Management accounting key roles are strategic management, reporting, and control, operations, and leadership (Kose & Agdeniz, 2019).

In the future, with the onset of big data and with business analytics using several different ways to analyze information, data will pervade most accounting fields, including managerial accounting. Affected will be the decisions for product mix, make or buy, pricing, and profitability. Analytic data will become an intangible asset equal to personnel, machinery, and real estate. In this globalized business world, there is an overwhelming need to keep pace with rapid change. Successful businesses will be able to change in real-time with fluidity and ease. There will be a replacement and integration of simple modeling policies into models of advance statistical data allowing managers to make changes and test even small theories (Steen, 2018).

The traditional utilization of the general ledger continues to change by automation as managers continue to ask for more from their management accountants. Today's management accountants are challenged by explosive changes to forecasts and putting the rigor of the budgetary process on edge. More questions about the story behind the numbers remain, and the expectation is management accountants will have the answers. Management accountants are at the cusp of this evolution, analyzing metadata to create a strategic analysis for management, integrating these skills to not only divulge prospective strategy but also to anticipate trends for operational data. Tomorrow's management accountants should rise above the profession's historical competencies and stereotypes to become

real business colleagues and bridge the gap of what the business desires with the customer and the enterprise data accumulated by the organization (Eng, 2018).

Accounting Education

Accounting education holds a long history of identifying the needs of the industry and adapting the curriculum to meet those needs. Because data analytics may develop into a stand-alone major, business schools should teach it (Tschakert et al., 2017). Demand is continually increasing for graduates with data analytics in their educational background (Dzuranin et al., 2018).

Unlike the predictions of some researches on the demise of accounting as a profession (Frey & Osborne, 2013), academia is familiar with the specific skill set needed to be an accountant and the unique qualifications which an accountant brings to an organization. With the identification of accountants with data analysis as an identified need, the accounting curriculum has evolved. The expectation is that universities produce properly trained accountants, and because of this expectation, schools must evolve with the profession (Dewu & Barghathi, 2019).

Future Research

There are areas in management accounting with limited research conducted. This paper touched on some, for example, business intelligence. Torres & Sidorova (2019) remarked there are many unanswered questions on how business intelligence contributes to an organization. Research has failed to consider how BI plays a role in organizational spontaneity (Peters et al., 2018). Research is needed to see if SMEs take advantage of cloud-based business intelligence solutions (Trigo et al., 2014).

There is also some research to be done in analytics, as all the additional data bought on by big data needs to be analyzed. There is a lot of unknown information concerning the role of management accountants in company strategies supported by analytics (Rikhardsson & Yigitbasioglu, 2018). From an accounting analytics viewpoint, Nielsen (2018) recommended research to produce new and enticing solutions for accounting with a data-related and comprehensive view as the beginning point. In accounting education, research needs to be conducted that includes the opinions of professional bodies of accounting (Dewu & Barghathi, 2019). Lastly, an empirical study of the managerial accounting framework to use data analytics in the surroundings of an enterprise system is necessary before its application (Appelbaum et al., 2017).

Conclusion

This paper presented a broad overview of emerging technological fields in management accounting. It began with a look at the current state of management accounting and how the role of management accountants has expanded into the vital supplier of information for business decisions. The next section explored business intelligence and its essential contribution to managerial accounting. Accounting analysis, the main feeder for business intelligence, followed the section on BI. Big data rounded out the technological aspects of the article on emerging technologies; this section described big data and how it shapes management accounting moving forward. A discussion ensued on each of the emerging technologies, and this section also included future impacts on management accounting, the evolution of accounting education, as well as a look at recommendations for future research in the field of management accounting.

References

- Acito, F., & Khatri, V. (2014). Business analytics: Why now and what next? *Business Horizons*, 57(5), 565–570.
<https://doi-org.ezp.waldenulibrary.org/10.1016/j.bushor.2014.06.001>
- Amato, N. (2016). Why the power of data is in the analysis. *Journal of Accountancy*. 54(2), pp-68-69.
<https://www.journalofaccountancy.com>

- Andrei, G., Galmeanu R., & Radu, F. (2018). Managerial accounting - an essential component of the information system. *Valahian Journal of Economic Studies*, 9(2), 109–114. <https://doi-org.ezp.waldenulibrary.org/10.2478/vjes-2018-0022>
- Appelbaum, D., Kogan, A., Vasarhelyi, M., & Yan, Z. (2017). Impact of business analytics and enterprise systems on managerial accounting. *International Journal of Accounting Information Systems*, 25, 29–44. <https://doi-org.ezp.waldenulibrary.org/10.1016/j.accinf.2017.03.003>
- Brands, K. (2014). Big data and business intelligence for management accountants. *Strategic Finance*, 95(12), pp 64–65. <https://sfmagazine.com/editorial-guidelines-submissions/>
- Contrafatto, M., & Burns, J. (2014). Social and environmental accounting, organizational change and management accounting: A processual view. *Management Accounting Research*, 24(4), 349–365. <https://doi-org.ezp.waldenulibrary.org/10.1016/j.mar.2013.10.004>
- Dewu, K., & Barghathi, Y. (2019). The accounting curriculum and the emergence of Big Data. *Accounting & Management Information Systems / Contabilitate Si Informatica de Gestiuine*, 18(3), 417–442. <https://doi-org.ezp.waldenulibrary.org/10.24818/jamis.2019.03006>
- Dzurainin, A. C., Jones, J.R., and Olvera, R.M. (2018). Infusing data analytics into the accounting curriculum: A framework and insights from faculty. *Journal of Accounting Education*, 43, 24–39. doi: 10.1016/j.jaccedu.2018.03.004.
- Eng, A. C. (2018). Tomorrow's management accountants. *Strategic Finance*, 6. <https://sfmagazine.com/>
- Frey, C. B., & Osborne, M. A. (2017). The future of employment: How susceptible are jobs to computerisation? *Technological Forecasting & Social Change*, 114, 254–280. <https://doi-org.ezp.waldenulibrary.org/10.1016/j.techfore.2016.08.019>
- Hint, M., Popa, M.-A., Trif, M., & Bădescu, M. (2018). New dimensions of managerial accounting and its influences in an unstable environment. *Annals of the University of Oradea, Economic Science Series*, 27(1), 181–191. <https://doaj.org/>
- Huttunen, J., Jauhiainen, J., Lehti, L., Nylund, A., Martikainen, M., & Lehner, O. M. (2019). Big Data, Cloud Computing and Data Science Applications in Finance and Accounting. *ACRN Oxford Journal of Finance & Risk Perspectives*, 8, 16–30. <http://www.acrn-journals.eu/>
- Ioana, M. T., Ioana, A. F., Nicoleta, D. G., & Gabriela, M.T. (2019). Know-how present status of insurances domain from the perspective of managerial accounting. *Annals of the University of Oradea, Economic Science Series*, 28(1), 194–202. <https://doaj.org/>
- Janvrin, D. J., & Weidenmier, W. M. (2017). “Big Data”: A new twist to accounting. *Journal of Accounting Education*, 38, 3–8. <https://doi-org.ezp.waldenulibrary.org/10.1016/j.jaccedu.2016.12.009>
- Kabir, M. R. (2019). Management accounting dynamics in bangladesh: Areas and factors behind the changes. *Asia-Pacific Management Accounting Journal*, 14(2), 51–77. <https://apmaj.uitm.edu.my/>
- Kose, T., & Agdeniz, Ş. (2019). The role of management accounting in risk management. *Journal of Accounting & Finance*, 509–525. <https://doi-org.ezp.waldenulibrary.org/10.25095/mufad.607200>
- La Torre, M., Botes, V.L., Dumay, J., Rea, M.A. & Odendaal, E. (2018). The fall and rise of intellectual capital accounting: new prospects from the Big Data revolution. *Meditari Accountancy Research*, 26(3), 381–399. <https://doi-org.ezp.waldenulibrary.org/10.1108/MEDAR-05-2018-0344>
- Lawson, R. (2019). New Competencies for Management Accountants. *CPA Journal*, 18–21. <https://www.cpajournal.com/>
- Moreno, V., Vieira da Silva, F. E. L., Ferreira, R., & Filardi, F. (2019). Complementarity as a Driver of Value in Business Intelligence and Analytics Adoption Processes. *Revista Ibero-Americana de Estratégia (RIAE)*, 18(1), 57–70. <https://doi-org.ezp.waldenulibrary.org/10.5585/ijsm.v18i1.2678>
- Nicoletta, G. C. (2019). Management accounting: The boundary between traditional and modern. *Journal of Academic Research in Economics*, 11(2), 453–461. <https://www.jare-sh.com/>
- Nielsen, S. (2018). Reflections on the applicability of business analytics for management accounting – and future perspectives for the accountant. *Journal of Accounting & Organizational Change*, 14(2), 167–187. <https://doi-org.ezp.waldenulibrary.org/10.1108/JAOC-11-2014-0056>
- Peters, M. D., Wieder, B., & Sutton, S. G. (2018). Organizational improvisation and the reduced usefulness of performance measurement BI functionalities. *International Journal of Accounting Information Systems*, 29, 1–15. <https://doi-org.ezp.waldenulibrary.org/10.1016/j.accinf.2018.03.005>
- Richins, G., Stapleton, A., Stratopoulos, T. C., & Wong, C. (2017). Big Data Analytics: Opportunity or Threat for the Accounting Profession? *Journal of Information Systems*, 31(3), 63–79. <https://doi-org.ezp.waldenulibrary.org/10.2308/isys-51805>
- Rikhardsson, P., & Yigitbasioglu, O. (2018). Business intelligence & analytics in management accounting research: Status and future focus. *International Journal of Accounting Information Systems*, 29, 37–58. <https://doi-org.ezp.waldenulibrary.org/10.1016/j.accinf.2018.03.001>

- Steen N. (2018). Reflections on the applicability of business analytics for management accounting – and future perspectives for the accountant. *Journal of Accounting & Organizational Change*, 14(2), 167–187. <https://doi-org.ezp.waldenulibrary.org/10.1108/JAOC-11-2014-0056>
- Tamandeh, S. (2016). The effect of business intelligence on management accounting information system. *European Online Journal of Natural and Social Sciences*, 5(1), pp. 190-199. <http://european-science.com/eojnss>
- Torres, R., & Sidorova, A. (2019). Reconceptualizing information quality as effective use in the context of business intelligence and analytics. *International Journal of Information Management*, 49, 316–329. <https://doi-org.ezp.waldenulibrary.org/10.1016/j.ijinfomgt.2019.05.028>
- Trigo, A., Belfo, F., & Estébanez, R. P. (2014). Accounting Information Systems: The Challenge of the Real-time Reporting. *Procedia Technology*, 16, 118–127. <https://doi-org.ezp.waldenulibrary.org/10.1016/j.protcy.2014.10.075>
- Tschakert, N., Kokina, J., Kozłowski, S., & Vasarhelyi, M. (2017). How Business Schools Can Integrate Data Analytics into the Accounting Curriculum. *CPA Journal*, 87(9), 10–12. Retrieved from <https://search-ebshost-com.ezp.waldenulibrary.org/login.aspx?direct=true&db=bth&AN=124942824&site=eds-live&scope=site>
- Vultur, P. (2018). Study based on the importance of the information provided by management accounting on the managerial process in the joint stock companies in the north-east area of moldova. *USV Annals of Economics & Public Administration*, 18(1), 134–142. <http://www.seap.usv.ro/annals/ojs/index.php/annals>
- Warren, J., Moffitt, K. C., & Byrnes, P. (2015). How Big Data Will Change Accounting. *Accounting Horizons*, 29(2), 397–407. <https://doi-org.ezp.waldenulibrary.org/10.2308/acch-51069>



The Role of Well-being on the Impact of High Performance Work Systems on Physicians' Job Burnout

Thadeus Mkamwa¹

¹ St. Augustine University of Tanzania, Faculty of Business Administration.
Email: thadeus.mkamwa@gmail.com

Abstract

This is a theoretical paper which examines the role of physicians' wellbeing in the relationship between utilization of High Performance Work Systems (HPWS) and Physicians' job burnout. The research is aimed at recommending a new model which should be adopted when researchers are identifying gaps that exist in theory and methodology on the link between HPWS and employee outcomes. The paper adopts among other theories a Critical Theory perspective which calls for Axel Honneth's three spheres of relationships in the communication between employees and employers. The paper starts by mapping key concepts on HPWS, physicians' well-being and physicians' burnout. The paper also identifies types of evidence that link HPWS with physicians' well-being and physicians' burnout. It ends with synthesizing existing knowledge on reducing physicians' burnout and improving physicians' well-being. Overall, the study proposes that in order to improve employee wellbeing and get away with the 'pessimistic perspective' which claims that HR practices are harmful to the employees' well-being, employers are obligated to examine operations which are based on 'personal relationships' which are either contractual or non-contractual, but still legally binding. In this way, workplaces which are using HPWS will reduce physicians' burnout and improve their wellbeing. Discussion, recommendation for future research and conclusion are made.

Keywords: High Performance Work Systems, Physicians' Wellbeing, Physicians' Job Burnout

1. Introduction

Much as researchers claim that there is neither a commonly accepted definition nor a gold standard for measuring quality of life (Katschnig, 2006:139), however, in measuring people's well-being, there is a universal agreement that quality of life is a multi-dimensional construct integrating physical, emotional, and social well-being and functioning as perceived by the individual (Lutz et al., 2007). The definition by Lutz et al. (2007) derives from the World Health Organization Quality of Life Assessment (WHOQOL), which states that quality of life (QoL) is an individual's perception of their position in life in the context of the culture and value systems in which they live and in relation to their goals, expectations, standards and concerns.

The dilemma on employees' well-being and productivity at work has been discussed and studies made without conclusive remarks (Peutere, Saloniemi, Aho, Natti, & Nummi, 2018). According to the Europe 2020 Strategy

(European Commission, 2010), the future prosperity of European workers is not based on low wages but on the high quality of working life. This makes it clear that the issue of employees' well-being and quality of life is not only an organizational or academic issue but also a political issue. Thus, improving quality of work has a potential benefit in raising worker well-being and lowering the social costs of ill-health (Felstead, Gallie, Green & Henseke, 2019).

Physicians are employees whose well-being is an issue of importance for several reasons besides the political and academic grounds mentioned above. These include:

- a. That Medicine is a unique organizational environment in which the health of physicians may be a significant risk factor for inadequate patient safety and suboptimal care. Likewise, globally, physicians are reporting increasing levels of job burnout, especially among younger physicians in training (Montgomery, 2014).
- b. Studies suggest that quality of healthcare systems is also dependent on the physicians' well-being (Wallace, Lemaire & Ghali, 2009). In surgical literature links have been established between patients' safety, medical errors, quality of life and burnout (Shanafelt, Balch, Bechamps, Russell, et al., 2010).
- c. Ethically, constant changes in the workplace context make employees' concerns secondary and neglected which erode work-related well-being which may result into negative consequences to both employees and organizations (Guest, 2017; Beer, Boselie, & Brewster, 2015).

Besides views in Strategic HRM on the negativity of HRM practices on physicians' well-being, the current concern in HRM literature is that while globally physicians are at risk of leaving their jobs and engage in different specialties; in some countries, physicians have been leaving their countries to other countries to seek for better employment environment than their own. Notwithstanding, studies are conscious of unethical trend in workplaces which encourages HRM practices which promote productivity and performance at the expense of employee well-being (Guest, 2017).

Several studies suggest that HRM practices and the so-called High-Performance Work Systems (HPWS) are associated with higher performance and higher organizational commitment, however outcomes for employees' health-related well-being are less clear-cut with some indication that HRM practices can be associated with higher stress (Guest, 2017:24; see also Van de Voorde, Paauwe, & Veldhoven, 2012; Peccei, van de Voorde & van Veldhoven, 2013). There is relatively dearth of research which links HPWS with physicians' well-being. However, for the past three decades, the literature on Strategic Human Resource Management and performance shows that researchers have focused much on organizational and performance-related outcomes and less on the health of the employees per se (Montgomery, 2016). This has led some researchers to claim that if there is any positive outcome of HRM practices to the employee well-being, then the outcome is a 'by-product' and not the intended target (Appelbaum Bailey, Berg, & Kalleberg, 2000; Guest, 2017). Studies show that individual as well as organizational work characteristics such as job monitoring, job control, effort-reward balance, organizational justice, and support at work, have predicted health-related outcomes at work (i.e., sickness, absence, and minor psychiatric morbidity (North, Syme, Feeney Head, Shipley, & Marmot, 1993; Kivimaki, Elovainio, Vahtera, & Ferrie, 2003; and Head, Kivimaki, Siegrist, et al., 2007).

Burnout is an aspect of employee health at work which is concerned with his or her physiological and psychological well-being (Danna & Griffin, 1999). Burnout among physicians is a problem which must not be ignored by any country. Estimates show that burnout levels among physicians is between 25% and 60% and can reach as high as 75% (Goehring, Bouvier, Kunzi & Bovier, 2005; Goitein, Shanafelt, Wipf, Slatore & Back, 2005). Burnout has also been associated with performance among physicians where major findings include burnout and depression being main sources of major medical errors among surgeons (Shanafelt et al., 2010). In this regard, there is great likelihood that physicians' burnout is an aspect of employees' well-being which puts their work and life at risk. If not well studied, physicians' work conditions may lead into poor policy decisions. This study is set to examine how organizations can reduce physicians' burnout and improve physicians' well-being. In this regard, the study explores the role of well-being in the relationship between the use of HPWS and physicians' job burnout.

1.1. Study Outline

This study is organized in the following manner:

- i. Introduction which covers study outline, study objectives and research questions
- ii. Theoretical concepts and arguments related to the topic
- iii. Identifying gaps that exist in theory and methodology
- iv. Mapping key concepts on HPWS, physicians' well-being and physicians' burnout
- v. Identifying types of evidence that link HPWS with physicians' well-being and physicians' burnout
- vi. Synthesizing existing knowledge on reducing physicians' burnout and improving physicians' well-being
- vii. Recommendation on a new model for future research
- viii. Conclusion

1.2. Study Objectives

This research seeks:

- i. To identify factors which show that physicians well-being is at risk
- ii. Examine the extent to which utilization of HPWS is related to the burnout problem
- iii. Suggest alternative ways to resolve the problem that exists between utilization of HRM practices (HPWS) and physicians' well-being

1.3. Research Questions

- i. To what extent is physicians' well-being at risk?
- ii. How is utilization of HPWS related to physicians' burnout and well-being?
- iii. What model is recommended to resolve the so called 'dark side of HPWS' and physician's well-being agenda?

2. Literature Review

2.1. Theoretical Constructs and Arguments

Theoretically, this study is informed by several theoretical perspectives. It is informed by Critical Theory - not much on its critique to capitalism, but on the way Max Horkheimer (from the Frankfurt Institute for Social Research, 1930s) conceived the possibility of rational organization of society where there is progress in the human domination of nature and emancipation of individuals. Unlike other traditional forms of critical theory, this theory conceives of itself as part of a struggle for an "association of liberated human beings, in which everybody would have an equal chance of self-development" (Wellmer, 2014:706).

The study likewise adopts Axel Honneth's perspective of critical theory where he proposes three relational systems, i.e., the three 'spheres of action' in modern society, namely the sphere of personal relationships, the sphere of the market economy, and the sphere of the political public (Honneth, 2014:131). The 'sphere of personal relationships' explains and enriches our understanding of the potential mechanism behind the relationship between the employer and the employee. The understanding is based on the principles of legitimation such as 'social freedom' in this particular sphere of action (Wellmer, 2014). The theory also highlights the importance of examining contractual and non-contractual roles and obligations in relational systems since they are based on legal systems (Honneth, 2014).

Another perspective which is used in this study is the Job Demand Control Theory (Karasek 1979). This theory explains the mechanism behind potential negative relationship between HR practices, the so called HPWS and employee well-being, and thus increased physicians' burnout. The 'demand-control' model of stress, for example, predicts that jobs with higher demands combined with low employee discretion or control will create the most strain (Gallie, 2005; Karasek, 1979). This theory therefore, calls for increased job control and autonomy which

must lead employees to positive health effects since “malleable features of the work environment are associated with perceived effects of work on health” (Ettner & Crzywacz, 2001:101). Work pressure and increased job demands especially long working hours have been linked to ill-being, i.e., negative indicators in employee well-being (Gallie, 2008), and increased work-life conflict (Gallie & Russell, 2009). The rationale behind these findings is a common perception that there is an increase in work intensity due to increased international competition. On the other hand, some researchers claim that despite an increase in skills development, job pressure can also be increased by additional responsibilities at work and decision making pressure (Gallie & Russell, 2009). Organizations are constantly competing to improve their productivity and performance based on the need for speed innovation. This has necessitated organizations to adopt just in time management processes, speed information transmission and decentralized decision making as organizational design methods. The blend between new technologies and new HR practices has led to the so called ‘time-based competition’ (Askenazy, Thesmar, Thoening, 2006) which puts more decision making pressure on employees.

Lastly, the study adopts Christophe Dejours’ Psychodynamics Theory of Work (Dashtipour & Vidaillet, 2017) which highlights situations in which workers should be supported by organizations to work well. With this theory, Dejours suggests that in the experience of working, based on unconscious dynamics, an encounter of the subject with the ‘real of work’ there is an affect of suffering which can or cannot be overcome or sublimated depending on circumstances. In this way, work is viewed as a field of exploitation for instrumental reasons. The theory, however, calls for collective organizational action or cooperation to transforming such affect into pleasure or good health (Dashtipour & Vidaillet, 2017). In this regard, this research is informed by Dejours concern in the process of work as described below:

Dejours’ work is concerned with identifying the conditions that turn the experience of work either into one of pleasure, subjective expansion, and freedom or one of pathological suffering. ...work is central to subjectivity and health, to the relationship between men and women, to the community, and finally to the theory of knowledge (Dashtipour & Vidaillet, 2017:19).

These theories explain potential mechanism behind the suggestion that based on the nature of their profession, physicians’ well-being is at risk in their working environment. Traditionally, the Labor Process Theorists posit that there are different and fundamentally opposite interests between employers and employees. According to Godard (2004, 2010) the need for profit overrides employees’ well-being in organizations. In this regard, should one take the Labor Process Theory perspective, HRM practices are considered as means through which employees are exploited. The practices are conceived to be managerial tools of control and monitoring resulting into employee compliance and performance (Grant, Christianson & Price, 2007).

2.2. Research Gap (Theory and Methodology)

Literature on the linkage between work and health show inconsistencies in findings across studies which could be due to methodological differences or theoretical biases (Ettner & Crzywacz, 2001) or dataset employed and specification tested (Godard, 2010). Another aspect that might be related to inconsistent findings might be geographical or national differences of the study areas (Godard, 2010). Notwithstanding, for about three decades, studies have shown that implementation of HRM practices the so called HPWS lead into positive employee behavioral outcomes such as discretionary efforts and extra role behaviors in the workplace (Huselid, 1995; Berg, Kalleberg, & Appelbaum, 2003; Elorza, Harris, Aritzeta & Balluerka, 2016). These practices have also been termed HR enhancing practices in the sense of enhancing skills, motivation and empowerment among employees (Subramony, 2009; Rauch & Hatak, 2016). HPWS have also been associated with reduced employee turnover (Huselid, 1995; Fabi, Lacoursiere & Raymond, 2015; Sikora, Ferris, & van Iddekinge, 2015). However, studies have also shown mixed results to the same research questions. Bryson & Forth (2015) for example have shown that increases in workload (worker output per hour/employees working harder) alongside static wages, has reduced fairness and threatened well-being but no evidence of improved productivity.

Notwithstanding, we are observing a movement of physicians from one country to another. These movements of physicians suggest that our understanding of the work conditions among physicians or the relationship between

them as employees and their employers is still limited. This gap of knowledge necessitates further research on the factors behind this process or the reasons behind this phenomenon. Another gap is on the way research is carried out in this HRM practices-well-being relationship. Several studies have used HR officers to ask questions about employee well-being instead of asking employees themselves. This has led to having unrealistic research procedures (e.g., common method variance) and unreliable findings since employees themselves are the best knowledgeable people of their own work conditions and their psychological or physical well-being. It is good to cite here what Kinnie, Hutchinson, Purcell, Rayton & Swart (2005:11) highlighted on this point noting that, 'the fulcrum of the HRM-performance causal chain is the employees' reactions to HR practices as experienced by them.' In this regard, our proposition is that physicians' well-being must have a role in mediating the impact of HPWS and employee work-related outcomes (these outcomes can be attitudinal or behavioral).

2.3. Mapping key concepts of HPWS

There are different approaches to understanding HRM and in particular understanding the utilization of the 'progressive' or 'high-road' HRM practices the so called HPWS (Peccei et al., 2013:16). Concepts which have been used to connote HPWS (Huselid, 1995; Appelbaum et al., 2000) include High Involvement Practices (Batt, 2000; Guthrie et al., 2001), HR enhancing practices (Sabramony, 2009), and high commitment practices (Arthur, 1994; Pfeffer, 1998). These HRM practices are characterized by the relationship between employers and employees whereby employers provide to employees the following:

- a. Opportunities for worker involvement and participation
- b. Intensive training and development, and
- c. Incentives (Wood & de Menezes, 2011)
- d. Other provisions such as providing employees with skills, knowledge and abilities, motivation and opportunities to perform their primary role task (Appelbaum et al., 2000). These approaches are meant to elicit employees' discretionary behaviors and discretionary efforts (Berg, Kalleberg, & Appelbaum, 2003; Shin & Konrad, 2017).

Besides the 'high-road' or 'progressive' HR practices, HRM is also related to 'exploitative' or 'low-road' HRM practices in employer-employee relationships (Peccei et al. 2013; Ramsay, Scholaris & Harley, 2000). These exploitative practices are a source of concern to HRM researchers and practitioners since they contribute to the 'dark side of HRM-performance' linkages. As transactional HRM systems, they include practices such as low pay, long hours, tight monitoring, low discretion, and job insecurity (Peccei et al., 2013:17).

While many studies over the past three decades have shown that High Performance Work Systems (HPWS) may benefit employers since they increase organizational performance by eliciting employee discretionary behaviors and employees in turn exhibit discretionary efforts (e.g., Berg, Kalleberg, & Appelbaum, 2003; Takeuchi, Chen & Lepak, 2009; Zatzick & Iverson, 2011; Elorza, Harris, Aritzeta, & Balluerka, 2016; Shin & Konrad, 2017), there are claims that HPWS can also (adversely) work at the cost of employee outcomes. The rationale behind this suggestion is that by their very nature HPWS could push employees to work harder to raise productivity at the cost of their well-being (e.g., Ramsay, Scholaris & Harley, 2000; Wood & De Menezes, 2011; Jensen, Patel & Messersmith, 2013, Van De Voorde & Jensen, 2016; Misra, 2018). Another view which is based on the AMO Model (Appelbaum et al., 2000) suggests that when employees are encouraged to use their Abilities when given Opportunities to do so, and when they are Motivated, their performance outcome is not an end to their benefit, rather they are used for the benefit of the organization and not for their well-being (Boxall, Guthrie & Paauwe, 2016; Guest, 2017). In this regard, under this perspective, it is claimed that HPWS has failed to service the goal of employee well-being. Overall, these scholars present what has been called the 'dark side' of High-Performance Work Practices (Van De Voorde & Jensen, 2016; Misra, 2018).

2.4. Mapping Key Concepts of Employee Well-being

Grant, Christianson & Price (2007:52) define employee well-being as 'the overall quality of an employee's experience and functioning at work.' Literature shows that there are different aspects of employee well-being. These include mental or psychological well-being, work-related well-being such as job satisfaction, and "general"

well-being, like depression and anxiety. Well-being can also be "context-free well-being" or "domain-specific" (e.g., work-related) well-being (Warr, 2007; De Witte, Pienaar & De Cuyper, 2016). Psychologists and sociologists have also developed a well-being index which includes psychological, physical and social parameters in order to capture a person's general well-being (Diener & Seligman, 2004; Grant, Christianson & Price, 2007).

Research has demonstrated that employee well-being is an important concern for organizations. Studies indicate that employee well-being has a significant impact on the performance and survival of organizations by affecting costs which are related to illness and health care (Danna & Griffin, 1999). The changing work environment suggests that there is increased work demands, work overload, and pressures at work which negatively affect employee work-related well-being (Guest, 2017; Derks & Bakker, 2010). A study by Felstead et al. (2019), for example, found that in the UK, in low skilled jobs, average levels of autonomy have declined, and work demands have increased. In similar manner, job insecurity is another aspect which affects employee work-related well-being (De Witte et al., 2016).

2.5. Link between HPWS and Well-being

Traditionally, the mainstream HRM scholars argue that there is a positive relationship between perceptions of HRM and employee well-being (Peccei, 2004). However, several studies have attempted to link HPWS and employee outcomes such as job-related well-being with different results including negative correlations and mixed results findings (Ramsay, Scholarios, & Harley, 2000; Godard, 2004; Guest, 2017). The positive side of HPWS or also called the 'high-road approach to management' (Ramsay, Scholarios, & Harley, 2000) has been and is still demonstrated by studies which link HPWS with organizational and employee outcomes across different sectors and contexts. According to some of the studies, these HR practices are associated with higher levels of well-being (Alfes, Shantz & Truss, 2012) and lower levels of stress and emotional exhaustion (Kalmi & Kauhanen, 2008). On the other hand, the critical HRM research has focused on the negative aspects of HRM practices in the sense of viewing performance management practices as coercive or inequitable management device (De Witte, 2016). This is the so called 'exploitative' or 'low-road' HRM systems (Peccei et al., 2013; Batt, 2000). These two distinct approaches to the problem always call for further research on resolving the debate on whether HRM practices in particular the HPWS are positive to employees' well-being or not.

Table 1 below provides empirical studies which have examined the link between HRM practices and employee well-being.

Author(s)	Research Study/Country	Design, Sample & Response Rate	Findings
Boxall, P. & Macky, K. (2008)	High Involvement Management Processes (HIWPs), work intensification and employee well-being	Interviews of 1004 New Zealand employees through Computer Assisted Telephone Interviews (CATI). Response rate was 34.2%. Results are based on 775 permanent employees. 58.9% were working in the private sector, followed by government department 12.6%. The interviews collected self-report perceptual data plus factual data of a personal nature	Mixed results: a) HIWPs were associated with higher job satisfaction, a better work-life balance, lower work intensification and no increased stress or fatigue. b) With increased pressure to work long hours, work overload, and job demands; HIWPs were associated with job dissatisfaction, higher stress and fatigue, and greater work-life imbalance.
Bryson, A. & Forth, J. (2015)	Study on the impact of recession on productivity on British workplaces (2004-2011) with 5 or more employees in private sector. Focus on change in organizational characteristics & individual productivity	Data used is the 2011 Workplace Employment Relations Survey 2011 (WERS). Data was collected from managers, worker representatives and employees in 2,700 workplaces with 5+ employees	Mixed results: Increases in workload (worker output per hour/employees working harder) alongside static wages. This has reduced fairness and threatened well-being but no evidence of improved productivity.

De Witte, H., Pienaar, J. & De Cuyper, N. (2016).	Examination of normal causation on the consequences of job insecurity for health and well-being	Analysis of scientific and scholarly databases for articles on employee well-being and job insecurity between 1987 and 2015. Overall, 84 articles were identified, and 57 longitudinal studies were analyzed. Most studies came from the European Union (64.9%) and 26.3% from USA and Canada, and the rest from other countries, i.e., China, Japan, and South Korea.	From 57 longitudinal studies, the study found evidence that job insecurity influences employee (somatic) health and negatively impact on (psychological) well-being over time.
Felstead, A., Gallie, D., Green, F. & Henseke, G. (2019).	Examination of the links between intrinsic job quality, work pressure, work autonomy, and worker's well-being.	Longitudinal study, with panel data from responses made in 2012 and 2014. a). Original cross-sectional study included 2782 interviews with workers aged 20–65. b) 1108 of 2497 from 2012 were re-interviewed using around half of the questions they were asked in 2012 c) Response rate to the 2012 survey was 49%, and 71% in the follow-up survey d) The results are based on 908 respondents who were employees in both surveys	Mixed results: 1. High involvement management practices decreased required effort but increased discretionary effort and reported levels of work exhaustion fell. 2. Increase in the extent of workplace computerization increased work exhaustion rate, but also increased discretionary effort.
Ungureanu, P., Bertolotti, Pilatti, M. (2019).	Comparative study on conditions for perceived Well Being Initiatives (WBIs) and received WBIs between employees and employers in 3 global companies which employ between 1,500 to 80,000 people.	Design: Qualitative Study using Grounded theory approach. Methods: use of available information (reports & strategic documents, archival data, etc.), open ended interviews with Vice President HRs, semi-structured interviews to top management, founder, HR managers and other employees from different sections. Three sites were sampled from manufacturing (200 people), tertiary (64) and 130 from quaternary services i.e., (knowledge-intensive).	There is a need for alignment of employees' attributions and employers' intentions of WBIs in implementing strategic businesses. Shared strategic intentionality shaped employees' perceptions of the WBIs packages they were offered by the employers. Effective WBIs in organizations depend on alignment of employers' intentions and employees' attributions of the initiatives made.
Villajos, E., Tordera, N., Jose M. Peiro, J.M., & Van Veldhoven, M. (2018).	Assessment of the links between employee perceptions, organizational performance and job-related employee well-being	Study 1: Participants were contacted by postgraduate students who participated in the research. Sample was 554 employees who completed the survey Majority 60.3% from service sector. Study 2: 1647 employees from 41 Spanish organizations from different sectors. HR or Firm Manager participated - Questionnaire based. 81% from the service sector	Employee support bundle (HR practices supporting employees) is a strong predictor of life satisfaction and an indicator of employee well-being General life well-being is generally and strongly related to HR employee -support practices
Wood, S., Van Veldhoven, M., Croon, & De Menezes, L. (2012).	Assessing the extent enriched job design and HIM practices influence employee well-being by testing two aspects of well-being (job satisfaction and job-related anxiety-comfort)	UK's Workplace Employment Relations Survey 2004. <i>Workplace data</i> - data from managers - face to face interview with senior person - 2295 workplaces. Response rate was 64%. <i>Employee data</i> – survey of employees, self-completion questionnaire, 22,451 employees, response rate was 61%. Findings are based on the sample of 14,127 employees and 1177 workplaces.	Mixed results: High-involvement management practices were negatively associated with well-being but had a positive association with performance.

2.6. Mapping Key Concepts of Employee Burnout

Burnout is a work-related stress disorder which affects many people in working age which results from a combination of many factors both work-related and individual-related (Salminen, Andreou, Holma, Pekkonen, & Mäkikangas, 2017). The term burnout has been used to describe different realities of people's experiences at work from fatigue, stress, loss of idealism and passion for one's work to psychological syndrome as response to chronic stressors in the job (Maslach, Schaufeli & Leiter, 2001). Three dimensions of burnout have been identified; overwhelming exhaustion, feeling of detachment from one's job and lack of accomplishment (Maslach, Schaufeli & Leiter, 2001). Some of identified factors which contribute to burnout include; time demands, lack of control,

work planning, work organization, difficult job situations and interpersonal relations (Montgomery, 2014). In assessing employee well-being, burnout has been considered as an individual problem, however, literature shows an increase in the evidence of factors that link burnout to organizational problems which are related to working environment and organizational culture (Montgomery, Todorova, Baban & Panagopoulou, 2013). Burnout, for example, is associated with patients' mortality and morbidity (Montgomery, 2014).

2.7. The Link between HPWS and Employee Burnout

McMurray, Linzer, Konrad, Douglas, Shugerman & Nelson (2000) carried a Physician Work Life Study. It was a survey which contained 150 items assessing career satisfaction and gender differences among multiple aspects of work life. The study adopted a nationally representative random stratified sample of 5,704 physicians in primary and specialty nonsurgical care (N = 2,326 respondents; 32% female, adjusted response rate = 52%). Their findings included that women had 1.6 times the odds of reporting burnout compared with men ($P < .05$), with the odds of burnout by women increasing by 12% to 15% for each additional 5 hours worked per week over 40 hours ($P < .05$). Lack of workplace control predicted burnout in women but not in men. Likewise, female physicians were more likely to report satisfaction with their specialty and with patient and colleague relationships ($P < .05$), but less likely to be satisfied with autonomy, relationships with community, pay, and resources ($P < .05$).

Likewise, a study by Dekker & Schaufeli (1995) examined the relationship between psychological distress and burnout. The findings included that job insecurity and exhaustion increased job burnout. Shanafelt et al. (2010) carried out a study on self-assessment of major medical errors, and standardized assessments of burnout and quality of life. The study was a cross-sectional survey in June 2008 with a sample of 7905 surgeons who are members of American College of Surgeons. The results showed that major medical errors reported by surgeons are strongly related to a surgeon's degree of burnout and their mental quality of life. In short, burnout was major predictor of medical errors.

Vander Elst, Van den Broeck, De Cuyper & De Witte (2014) carried a study on the links between job insecurity, job control and mental exhaustion. The study findings showed evidence of causation of loss of job control, mental exhaustion and its effect on well-being through control. Likewise, Mäkikangas & Kinnunen (2003) studied the relationship between job satisfaction and mental distress. Their findings included that job insecurity was related to ratings of emotional exhaustion and mental distress overtime. However, the study showed no effects for physical symptoms.

3. Discussion and Recommendation of a New Model

The discussion in this paper is based on the following question: how can this existing body of knowledge on the field help researchers suggest new models to reducing physicians' burnout and improving physicians' well-being? There is a connection between work conditions and health of employees. However, "multiple features of employment arrangements and workers' health is not well understood" (Ettner & Grzywacz, 2001:101) and that is why it needs to be studied. Considerable research in Strategic HRM has addressed this problem of the link between HRM practices and employee outcomes. Overall, researchers tend to agree that the conduit through which this problem can be resolved is "people." Peccei et al. (2013) for example, highlight that employee psychological, attitudinal and behavioral outcomes at work, including employee well-being, are hypothesized to play a key role in understanding the impact of HR practices on organizational and employee outcomes. In this regard, it is important to examine the mediating role of employee well-being in the impact of HR practices (i.e., HPWS) on individual or employee outcomes. By doing so, such research will be contributing to the debate on understanding the 'black box' problem which needs a critical review and empirical evidence in the SHRM literature.

There is an 'optimistic perspective' which claims that utilization of HRM practices is beneficial to the employees and that generally it improves employee attitudes, behaviors and their well-being (Peccei, 2004; Peccei et al., 2013). The basis and rationale behind this optimistic perspective is the social exchange theory (Blau, 1964; Gouldner, 1960) which asserts that employees will pay back favorably to the employers if they are treated well. In this regard, these HR practices are expected to increase employees' discretionary behaviors such as

commitment, and combined with employee empowerment and rewarding work environment, employees get quality work life (Peccei et al., 2013). Despite this optimistic perspective, however, researchers are cautious of the misuse of this perspective since it amounts to Pollyanna Fallacy which claims that people will always be looking at the positive aspects of things and thus will be grateful to those who have been good to them. This assertion is based on the norm of reciprocity theory (Gouldner 1960), which makes two minimal demands that “(1) people should help those who have helped them, and (2) people should not injure those who have helped them” (Gouldner, 1960:171).

David Guest (2017) suggests a configuration of employee and employer terms in resolving the problem of unequal gains between employers who extensively and intensively utilize HR practices (HPWS) at the expense of employees who are considered to be subjects or losers in this tension. While this study acknowledges this great suggestion, this study goes further than Guest’s suggestion in proposing the Critical Theory perspective which has been adopted in this study. Honneth’s three spheres of relationships have a bearing in what employees as individuals have to say in order to maintain their social freedom and configure their contractual and non-contractual obligations to the employer (2014:131). It is important to note what Kinnie et al. (2005:11) highlighted on this point noting that, 'the fulcrum of the HRM-performance causal chain is the employees' reactions to HR practices as experienced by them.'

In this regard, a new model which this study proposes is based on the Social Critical Theory. This study proposes that in order to get away with the ‘pessimistic perspective’ which claims that HR practices are harmful to the employees’ well-being, employers are obligated to examine operations which are based on ‘personal relationships’ which are either contractual or non-contractual, but still legally binding. In this regard, at personal level relationships, employers have to consider employees’ individual needs and properties, and at the market level they have to consider employees’ particular interests and abilities, and at political public sphere, they have to consider employee individual aims and self-determination (Honneth, 2014:131). By doing so, employees will be involved fully and will be exercising their individual and social freedom in the workplace.

4. Conclusion

The mediating role of physicians’ well-being in analysing the relationship between HPWS and physicians’ burnout is based on lack of (divergence from) policy emphasis on improving work conditions which is likely to have major leverage in reducing even other work-related problems such as work family conflict (Gallie & Russell, 2009). In this regard, in order to reduce physicians’ burnout in a HPWS workplace, policies on improving physicians’ well-being have to be aligned with employee interests. It should be remembered that research on burnout has its roots in care-giving and service occupations where the core business was the relationship between the provider and the recipient rather than a stress response to an individual (Maslach, Schaufeli & Leiter, 2001). So, establishing interpersonal relationships in the workplace might be the right thing to do in order to mitigate other symptoms of burnout such as psychological and physical ailments including mental health.’

References

- Alfes, K., Shantz, A. and Truss, C. (2012). The link between perceived HRM practices, performance and well-being: the moderating effect of trust in the employer. *Human Resource Management Journal*, 22 (4), 409–427.
- Appelbaum, E., Bailey, T., Berg, P. & Kalleberg, A. (2000). *Manufacturing Advantage: Why High-Performance Work Systems Pay Off*. Ithaca, NY: ILR Press.
- Arthur, J. B. (1994). Effects of human resource systems on manufacturing performance and turnover. *Academy of Management Journal*, 37(3), 670-687.
- Askenazy, P., Thesmar, D., & Thoenig, M. (2006). On the Relation Between Organisational Practices and New Technologies: The Role of (Time Based) Competition. *The Economic Journal*, 116(508): 128–154. <https://doi.org/10.1111/j.1468-0297.2006.01050.x>
- Beer, M., Boselie, P. and Brewster, C. (2015). ‘Back to the future: implications for the field of HRM of the multistakeholder perspective proposed 30 years ago.’ *Human Resource Management*, 54 (3), 427–438.

- Berg, P., Kalleberg, A. L., & Appelbaum, E. (2003). Balancing work and family: The role of high-commitment environments. *Industrial Relations: A Journal of Economy & Society*, 42(2), 168-188. <http://dx.doi.org/10.1111/1468-232X.00286>
- Blau, P. (1964). *Exchange and Power in Social Life*. New York: John Wiley.
- Boxall, P. & Macky, K. (2008). High-involvement work processes, work intensification and employee well-being: A study of New Zealand worker experiences. *Asia Pacific Journal of Human Resources*, 46(1): 38–55. [1038-4111] DOI: 10.1177/1038411107086542
- Boxall, P., Guthrie, J. and Paauwe, J. (2016). 'Editorial introduction: progressing our understanding of the mediating variables linking HRM, employee well-being and organisational performance.' *Human Resource Management Journal*, 26(2), 103–111
- Bryson, A. & Forth, J. (2015). 'The UK's Productivity Puzzle.' IZA Discussion Paper No. 9097. Centre for Economic Performance.
- Danna, K., & Griffin, R. W. (1999). Health and well-being in the workplace: A review and synthesis of the literature. *Journal of Management*, 25(3), 357-384.
- Dashtipour, P. & Vidaillet, B. (2017). Work as affective experience: The contribution of Christophe Dejours' 'psychodynamics of work.' *Organization*, 24(1), 18–35. DOI: 10.1177/1350508416668191
- Derks, D. & Bakker, A. (2010). The impact of e-mail communication on organizational life. *Cyberpsychology*, 4(1), 1–14.
- De Witte, H., Pienaar, J. & De Cuyper, N. (2016). Review of 30 years of longitudinal studies on the association between job insecurity and health and well-being: is there causal evidence? *Australian Psychologist*, 51(1), 18–31.
- Diener, E., & Seligman, M. E. P. (2004). Beyond money. *Psychological Science in the Public Interest*, 5(1), 1–31.
- Elorza, U., Harris, C., Aritzeta, A., & Balluerka, N. (2016). The effect of management and employee perspectives of high-performance work systems on employees' discretionary behaviour. *Personnel Review*, 45(1), 121-141. <https://doi.org/10.1108/PR-07-2014-0167>
- Ettner, S. L., & Grzywacz, J. G. (2001). Workers' perceptions of how jobs affect health: A social ecological perspective. *Journal of Occupational Health Psychology*, 6(2), 101-113. <http://dx.doi.org/10.1037/1076-8998.6.2.101>
- European Commission (2010) Europe 2020. A strategy for smart, sustainable and inclusive growth. Communication from the Commission, COM (2010) 2020 final, 3 March 2010, Brussels.
- Fabi, B., Lacoursiere, R. & Raymond, L. (2015). Impact of high-performance work systems on job satisfaction, organizational commitment, and intention to quit in Canadian organizations, *International Journal of Manpower*, 36(5):772-790. DOI: 10.1108/IJM-01-2014-0005
- Felstead, A., Gallie, D., Green, F. & Henseke, G. (2019). The determinants of skills use and work pressure: A longitudinal analysis. *Economic and Industrial Democracy*, 40(3) 730–754.
- Gallie, D. (2005). Work Pressure in Europe 1996–2001: Trends and Determinants. *British Journal of Industrial Relations*, 43(3):351-375. <doi/epdf/10.1111/j.1467-8543.2005.00360.x>
- Gallie, D. & Russell, H. (2009). Work Family Conflict and Working Conditions in Western Europe. *Social Indicators Research*, 93(3):445-467. DOI: 10.1007/s11205-008-9435-0
- Godard, J. (2004). A critical assessment of the high performance paradigm. *British Journal of industrial Relations*, 42(2), 349-378.
- Godard, J. (2010). What Is Best for Workers? The Implications of Workplace and Human Resource Management Practices Revisited. *Industrial Relations*, 49(3), 466-488. <https://doi.org/10.1111/j.1468-232X.2010.00610.x>
- Goehring, C., Bouvier, G.M., Kunzi, B., Bovier, P. (2005). Psychosocial and professional characteristics of burnout in Swiss primary care practitioners: a cross-sectional survey. *Swiss Med Wkly.*, 135(7–8):101–108.
- Goitein, L., Shanafelt, T.D., Wipf, J.E., Slatore, C.G., Back, A.L. (2005). The effects of work-hour limitations on resident well-being, patient care, and education in an internal medicine residency program. *Arch Intern Med.*, 165(22):2601–2606.
- Gouldner, A. (1960). The norm of reciprocity. *American Sociological Review*, 25(2): 161-178.
- Grant, A., Christianson, M. & Price, R. (2007). Happiness, health, or relationships? Managerial practices and employee well-being tradeoffs? *Academy of Management Perspectives*, 21(3), 51-63.
- Guest, D. (2017). Human resource management and employee well-being: towards a new analytic framework. *Human Resource Management Journal*, 27(1), 22-38. <https://doi.org/10.1111/1748-8583.12139>
- Head, J., Kivimaki, M., Siegrist, J., et al. (2007). Effort-reward imbalance and relational injustice at work predict sickness absence: The Whitehall II study. *Journal of Psychosomatic Research*, 63(4):433–440.
- Honneth, A. (2014). *Freedom's Right: The Foundations of Democratic Life*. Polity Press, Cambridge, UK.
- Jensen, J. M., Patel, P. C., & Messersmith, J. G. (2013). High-performance work systems and job control: Consequences for anxiety, role overload, and turnover intentions. *Journal of Management*, 39(6), 1699-1724. <https://doi.org/10.1177/0149206311419663>

- Kalmi, P. & Kauhanen, A. (2008). Workplace innovations and employee outcomes: evidence from Finland. *Industrial Relations: A Journal of Economy and Society*, 47(3), 430–459.
- Karasek, R. (1979). Job demands, job decision latitude, and mental strain: implications for job redesign. *Administrative Science Quarterly*, 24(2), 285–308. doi:10.2307/2392498
- Kinnie, N., Hutchinson, S., Purcell, J., Rayton, B. & Swart, J. (2005). Satisfaction with HR practices and commitment to the organisation: why one size does not fit all. *Human Resource Management Journal*, 15(4): 9-29. <https://doi.org/10.1111/j.1748-8583.2005.tb00293.x>
- Kivimäki, M., Elovainio, M., Vahtera, J., Ferrie, J.E. (2003). Organisational justice and health of employees: prospective cohort study. *Occup Environ Med.*, 60(1):27–33.
- Maslach, C., Schaufeli, W., & Leiter, M. (2001). Job burnout. *Annual Review of Psychology*, 52, 397–422. doi:10.1146/annurev.psych.52.1.397.
- Mäkikangas, A., & Kinnunen, U. (2003). Psychosocial work stressors and well-being: self-esteem and optimism as moderators in a one-year longitudinal sample. *Personality and Individual Differences*, 35, 537–557. doi:10.1016/S0191-8869(02)00217-
- McMurray, J.E, Linzer, M., Konrad, T.R., Douglas, J., Shugerman, R. & Nelson, K. (2000). The Work Lives of Women Physicians. *Gen Intern Med.* 15:372–380.
- Misra, K. (2018). High-Performance Human Resource Practices and Team Job Satisfaction: Moderating Role of Team Citizenship Behaviors. *International Journal of Human Resource Studies*, ISSN 2162-3058, Vol.8, No. 3, pp.86-102: <https://doi.org/10.5296/ijhrs.v8i3.13010>
- Montgomery, A.J. (2016). The relationship between leadership and physician well-being: a scoping review. *Journal of Healthcare Leadership*, 8:71–80.
- Montgomery, A., Todorova, I., Baban, A., & Panagopoulou, E. (2013). Improving quality and safety in the hospital: the link between organizational culture, burnout, and quality of care. *British Journal of Health Psychology*, 18(3): 656–662.
- Montgomery, A.J. (2014). The inevitability of physician burnout: implications for interventions. *Burnout Research*, 1(1):50–56.
- North F, Syme SL, Feeney A, Head J, Shipley MJ, Marmot MG. (1993). Explaining socioeconomic differences in sickness absence: the Whitehall II study. *BMJ*. 306(6874):361–366.
- Peutere, L, Saloniemä, A., Aho, S., Natti, J. & Nummi, T. (2018). High-involvement management practices, job control, and employee well-being in the public and private sectors. Evidence from Finland. *Transfer*, 24(4): 467–486: DOI: 10.1177/1024258918807387
- Peccei, R. (2004). Human Resource Management and the Search for the Happy Workplace, Rotterdam: Inaugural Lecture, Erasmus University Institute of Management.
- Peccei, R., van de Voorde, K. & van Veldhoven, M. (2013). 'HRM, well-being and performance: a theoretical and empirical review,' in J. Paauwe, D. Guest & P. Wright (eds), *HRM and Performance: Achievements and Challenges*, Chichester: Wiley, pp. 15–45.
- Ramsay, H., Scholarios, D., & Harley, B. (2000). Employees and high-performance work systems: Testing inside the black box. *British Journal of industrial relations*, 38(4), 501-531. <https://doi.org/10.1111/1467-8543.00178>
- Rauch, A. & Hatak, I. (2016). A meta-analysis of different HR-enhancing practices and performance of small and medium sized firms, *Journal of Business Venturing*, 31(5):485-504. DOI: 10.1016/j.jbusvent.2016.05.005
- Shanafelt, T.D., Balch, C.M., & Bechamps, G., et al. (2010). Burnout and medical errors among American surgeons. *Annals of Surgery*, 251(6):995-1000, DOI: 10.1097/SLA.0b013e3181bfdab3
- Salminen, S., Andreou, E., Holma, J., Pekkonen, M., Mäkikangas, A. (2017). Narratives of burnout and recovery from an agency perspective: A two-year longitudinal study. *Burnout Research*, 7, 1–9.
- Shin, D., & Konrad, A. M. (2017). Causality between high-performance work systems and organizational performance. *Journal of Management*, 43(4), 973-997. <https://doi.org/10.1177/0149206314544746>
- Subramony, M. (2009). A meta-analytic investigation of the relationship between HRM bundles and firm performance. *Human Resource Management*, 48(5), 745-768. <https://doi.org/10.1002/hrm.20315>
- Takeuchi, R., Chen, G. & Lepak, D.P. (2009) Through the looking glass of a social system: Cross-level effects of high-performance work systems on employees' attitudes. *Personnel Psychology*, 62(1): 1–29.
- Van de Voorde, K., Paauwe, J. & van Veldhoven, M. (2012). 'Employee well-being and the HRM-performance relationship: a review of quantitative studies.' *International Journal of Management Reviews*, 14: 4, 391–407.
- Van De Voorde, K., & Jensen, J. M. (2016). "High Performance at the Expense of Employee Health? Reconciling the Dark Side of High-Performance Work Systems." In *Understanding the High-Performance Workplace* (pp. 81-102). Routledge.
- Wallace, J.E., Lemaire, J.B., & Ghali, W.A. (2009). Physician wellness: a missing quality indicator. *Lancet*. 374(9702):1714–1721.

- Zatzick, C.D. & Iverson, R.D. (2011). Putting employee involvement in context: a cross-level model examining job satisfaction and absenteeism in high involvement work systems. *The International Journal of Human Resource Management*, 22(17): 3462–3476.
- Ungureanu, P., Bertolotti, F., & Pilatti, M. (2019). What drives alignment between offered and perceived well-being initiatives in organizations? A cross-case analysis of employer -employee shared strategic intentionality, *European Management Journal*, <https://doi.org/10.1016/j.emj.2019.03.005> (in press).
- Vander Elst, T., Van den Broeck, A., De Cuyper, N., & De Witte, H. (2014). On the reciprocal relationship between job insecurity and employee well-being: mediation by perceived control? *Journal of Occupational and Organizational Psychology*, 87, 671–693. doi:10.1111/joop.12068
- Warr, P. (2007). *Work, Happiness, and Unhappiness*. London: Lawrence Erlbaum Associates.
- Wellmer, A. (2014). On critical theory. *Social Research: An International Quarterly*, 81(3), 705-733.
- Wood, S., & De Menezes, L. (2011). High involvement management, high-performance work systems and wellbeing. *International Journal of Human Resource Management*, 22(7): 1585–1608.
- Wood, S., Van Veldhoven, M., Croon, & De Menezes, L. (2012). Enriched job design, high involvement management and organizational performance: the mediating roles of job satisfaction and well-being. *Human Relations*, 65(4): 419–446.



Analysis of Capital Adequacy Ratio, Prime Lending Rate, and Third-Party Funds on Profitability of Commercial Banks in Indonesia, With Liquidity as Intervening Variable

Purwani Pujiati¹, Zainul Kisman¹, Aam Bastaman¹

¹ Universitas Trilogi, Indonesia

Abstract

This study aims to determine the effect of Capital Adequacy Ratio, Prime Lending Rate, and Third-Party Funds on Profitability of Commercial Bank with Liquidity as an intervening variable. The sample of this research is the banks of the BUKU IV category listed in Bank of Indonesia and its financial statements published by the Indonesia Financial Services Authority (OJK) period 2009-2018, using a cluster sampling method. There are 5 banks of the BUKU IV category as the samples. Hypothesis testing using path analysis technique. The results of this research show that Capital has a positive and significant effect on Liquidity, Third-Party Funds (bank deposits) and Prime Lending Rate has a negative and significant effect on Liquidity. Thus Third-Party Funds has a positive effect on Profitability, then Capital and Liquidity have a negative effect on Profitability, meanwhile, Prime Lending Rate does not affect Profitability. The implication of this research that the liquidity policy is a determining variable acting as an important intermediary for linking Capital Policy, interest rates, and Third-Party Funds in order to increase bank profits.

Keywords: Capital Adequacy Ratio, Prime Lending Rate, The Third Party Funds, Loan to Deposit Ratio, and Return on Assets

I. INTRODUCTION

I.1. Introduction and research rationale

Since January 5, 2011, Bank Indonesia has made an instrument for assessing the soundness of banks, namely the regulation of bank soundness using the RGEC (Risk Profile, Good Corporate Governance, Earnings, and Capital) method. Through RGEC, Bank Indonesia wants banks to be able to identify problems early, by making appropriate and faster follow-up improvements, and to apply Good Corporate Governance (GCG) and better risk management so that banks are more resilient in facing crises (Bank Indonesia, 2011).

Lembaga Pengembangan Perbankan Indonesia (LPPI) (Yudistira & Dupla, 2017), noted a number of problems that occurred in Indonesian banking. Problems in the banking sector can be seen from several factors such as efficiency, profitability, capital, and problem loans.

Bank Indonesia (BI) must close national banks if the capital adequacy ratio (CAR) of banks is less than the BI regulation at 8% because this will only cause banks liquidity problems and cause problems. Reflecting on the Century Bank case, the banking regulator has changed the Bank Indonesia Regulation (PBI) which explains that the positive CAR has been able to receive the Short-Term Funding Facility (FPJP). Whereas in the previous PBI, only banks with a minimum CAR of two percent could only submit (Purwanto, 2016).

Chairman of the Board of Commissioners of the Indonesian Deposit Insurance Corporation (LPS) Halim Alamsyah expressed in a national seminar initiated by the Institute for Development of Economics and Finance (INDEF) in Jakarta in November 2017, that the level of bank profitability has continued to decline over the past five years due to the weak margins of lending, plus the high ratio of non-performing loans. For example, for a large asset bank or commercial bank Business Activity (BUKU) IV, the acquisition of ROA in December 2015 reached 4%, then decreased to the range of 2.5% to 3% in December 2016, and stagnated at around 3% in September 2017 (Baihaqi, 2017).

The same problem also befell banks with the category of Commercial Banks Business Activities (BUKU) III with a minimum capital of IDR 5 trillion to IDR 30 trillion, relatively stable from 1.84% in November 2017 to 1.82% in the same period in 2018. As a result, a number of BUKU III banks contacted by Kontan (Kontan.co.id) only set a stagnant ROA in 2019 (Sitanggang & Tendi, 2019).

Halim Alamsyah also highlighted slowing credit growth. In September 2017, loans grew by 7.9% or decreased compared to August 2017 which amounted to 8.4%. Another cause of bank profitability continues to decline, according to Halim, which is increasingly fierce banking competition, plus the entry of players in the financial services sector, such as the financial technology industry (fintech) (Rajagukguk, 2017).

Return on Assets (ROA) is a measure of bank profitability, which ratio is used to measure the performance and effectiveness of banks in obtaining profits by utilizing the assets they have. ROA calculation using the ratio between profit before tax to total assets owned.

In the annual Economic Report released by Bank Indonesia stated that aside from the aspect of profitability and financial ratios, banking performance can also be measured from the ability of banks to raise public funds (Third Party Funds) commonly referred to as DPK. The greater the funds owned by a bank, it is also accompanied by the large opportunities for the bank to carry out its activities in achieving its objectives (Nandadipa, 2010).

Several authors have conducted similar studies with research conducted by the author on the performance of this bank, including by (Parenrengi & Hendratni, 2018), (Pardede, 2016), (Haryoso & Kusdiasmo, 2016), (Yanti & Masdjojo, 2018), and (Widiarti, Siregar, & Andati, 2015), regarding the analysis of several variables, which influence different variables in each study of bank performance.

I.2. Research Objectives

This study aims to analyze how the direct influence of CAR, SBDK and DPK variables on LDR and ROA variables, as well as the LDR effect on ROA, and the indirect effect of CAR, SBDK, and DPK on ROA through LDR as intervening variable, on banks that were collected in the BUKU IV group 2009-2018.

II. LITERATURE REVIEW AND HYPOTHESIS FORMULATION

Theory, Empirical Evidence, and Hypothesis Formulation

Return On Assets (ROA)

According to Van Horne & Wachowicz (2005), ROA measures the overall effectiveness in generating profits through available assets; the power to generate profits from invested capital. Munawir (2010) gives an understanding of ROA is one form of profitability ratios aimed at measuring the ability of companies with all funds used for company operations to generate profits. Whereas Syamsudin (2011) defines ROA as a measurement of the ability of a company to produce overall profits by means of the overall available assets. So ROA is a ratio

that shows how much net income can be obtained from all the wealth owned by banks because that is what is used is the profit rate after tax and the average bank wealth.

According to Bank Indonesia (2011), ROA can be calculated with the following formula:

$$\text{ROA} = \frac{\text{Net Profit Before Taxes}}{\text{Total Assets}}$$

Table 1. ROA Component Rating

Ratio	Rating	Predicate
ROA > 1,5%	1	Very Good
1,25% < ROA ≤ 1,5%	2	Good
0,5% < ROA ≤ 1,25%	3	Sufficient
0% < ROA ≤ 0,5%	4	Not Good
ROA ≤ 0%	5	Very Unkind

Source: SE BI No. 13/24/ DPNP 2011

Capital Adequacy Ratio (CAR)

According to Bank Indonesia (SE BI No. 13/24/ DPNP 2011) CAR is the provision of minimum capital for banks based on active risk in the broadest sense, both assets listed in the balance sheet and administrative assets as reflected in obligations that are still contingent and/or committed provided by banks for third parties as well as market risk. It can be concluded that CAR is the bank's performance ratio to measure the capital adequacy of banks to support assets that contain or generate risk, such as loans given to customers.

Bank Indonesia sets the minimum standard on CAR, which is 8%. This regulation is written in PBI No. 10/15 / PBI / 2008 article 2 paragraph 1 (BI: 2017). Based on Bank Indonesia Circular No. 3/30 / DPNP 2001 (BI: 2017). The CAR formula is as follows:

$$\text{CAR} = \frac{\text{Bank Capital}}{\text{Total of ATMR}} \times 100\%$$

Risk-Weighted Assets (ATMR) according to Sudirman (2013) is the total risk balance of bank balance sheets and administrative accounts. Balance sheet assets and administrative assets have been weighted according to a predetermined risk weighting level. Each item in an asset is assigned a risk weighting, the amount of which is based on the level of risk contained in the asset itself or the class of customers or the nature of the collateral. Supervision regarding the provisions on ATMR is to ensure that the maximum ATMR is based on the weighting set by Bank Indonesia. Risk weight ranges from 0-100% depending on the level of liquidity, the more liquid the assets, the smaller the risk weighting. The purpose of ATMR is to control the growth of bank assets that provide high returns with low risk.

Table 2. CAR component rating

Ratio	Rating	Predicate
CAR ≥ 12%	1	Very Good
9% ≤ CAR < 12%	2	Good
8% ≤ CAR < 9%	3	Sufficient
6% < CAR ≤ 8%	4	Not Good
CAR ≤ 6%	5	Very Unkind

Source: SE BI No. 13/24/ DPNP 2011

Prime Landing Rate (SBDK)

Judisseno (2002) said that interest rates are income earned by people who give excess money or surplus spending units to be used temporarily by people who need and use the money to cover their deficits or deficit spending units. Interest rates are the price of using investment funds (loanable funds). The interest rate is one indicator in determining whether someone will invest or save (Boediono, 2014).

Third-Party Funds (DPK)

According to Undang–Undang RI No. 10 1998 concerning Banking, third party funds (deposits) are funds entrusted by the public to banks based on fund storage agreements in the form of demand deposits, deposits, certificates of deposit, savings and or other similar forms. The bank obtains these funds from three sources namely, first-party funds from owners and bank profits; second party funds obtained through the money market; and third party funds sourced from public deposits in the form of demand deposits, savings, time deposits, certificates of deposit, and guarantee deposits. Of the three bank funding sources, third party funds contributed the most. Third-party funds are the most important source of funds for bank operations. These funds can be used to be placed in posts that generate income, one of which is credit.

The source of bank funds according to Kasmir (2014) is the bank's efforts to raise funds from the public. The acquisition of these funds depends on the bank itself, whether from community deposits or from other institutions. This is in accordance with the function of the bank that the bank is a financial institution in which its daily activities are engaged in finance, so the sources of bank funds are also inseparable from the financial sector itself. To support the bank's activities as a seller or provide loans, banks must first buy money or raise funds so that the difference in the interest the bank gets a profit.

Loan to Deposit Ratio (LDR)

According to Darmawi (2011), liquidity is a term used to indicate a stock of cash and other assets that are easily converted into cash. The banking health assessment tool in terms of liquidity factor that is often used is the LDR ratio.

In theory, the greater the amount of credit given, the higher the LDR and the smaller the amount of credit disbursed, the lower the LDR. This shows that the amount of credit given from a high LDR value will increase the amount of profit received by banks from interest income (Hamidah, Goldan, & Mardiyati, 2014).

The ability of banks to repay withdrawals of funds made by relying on loans provided as a source of liquidity is measured using the LDR ratio. LDR ratio comparison will be inversely proportional to bank liquidity, the higher the ratio, the lower the bank liquidity, and vice versa if the lower the LDR ratio, the higher the bank liquidity. According to Sudirman (2013), the LDR ratio can be formulated as follows:

$$\text{LDR} = \frac{\text{Credit}}{\text{Third - Party Funds}} \times 100\%$$

Table 3. LDR Component Ranking Criteria

Ratio	Ranking	Criteria
$\text{LDR} \leq 75\%$	1	Very Good
$75\% < \text{LDR} \leq 85\%$	2	Good
$85\% < \text{LDR} \leq 100\%$	3	Sufficient
$100\% < \text{LDR} < 120\%$	4	Not Good
$\text{LDR} > 120\%$	5	Very Unkind

Source: SE BI No. 13/24/ DPNP 2011.

Relationship of Capital Adequacy Ratio (CAR) to Loan to Deposit Ratio (LDR)

According to Hersugondo & Tamtomo (2012), it was found that during the research period partially, the Capital Adequacy Ratio variable had a positive and significant effect on LDR. This is intended so that the banking companies in Indonesia can make an optimal liquidity policy strategy so that the banking companies can still exist for now and in the future.

The results of data analysis proving that there is a positive and significant influence of CAR variables on LDR are also supported by the research of Ratu Edo & Wiagustini (2014), the greater the minimum capital (CAR) to overcome problems arising from bank assets that contain risks, the liquidity of a bank will get higher

The provisional hypothesis of the study is as follows:

H1: Capital Adequacy Ratio (CAR) affects the Loan to Deposit Ratio (LDR)

Relationship of Prime Lending Rate (SBDK) to Loan to Deposit Ratio (LDR)

According to Kasmir (2014), LDR is the ratio used to measure the composition of the amount of credit given compared to the number of public funds and own capital used. The higher the interest rate on credit, the less public interest in taking credit and vice versa, the lower the interest rate on loans, the higher the demand for credit from the public.

In a previous study, Fahrana (2018) found that loan interest rates had a positive but not significant effect on loans.

Provisional hypothesis formulation of these variables is as follows:

H2: Prime Lending Rate (SBDK) affects Loan to Deposit Ratio (LDR)

Relationship of Third Party Funds (DPK) to Loan to Deposit Ratio (LDR)

An increase in third party funds will result in credit growth, therefore the growth of DPK has a positive effect on LDR (Nandadipa, 2010).

Delsy Setiawati Ratu Edo's research (2014) proves that there is a positive and significant influence of the variable Third Party Fund (DPK) on Loan to Deposit Ratio (LDR). This hypothesis is also supported by Sharvina (2017) which shows that Third Party Funds (DPK) has a positive and significant effect on Loan to Deposit Ratio (LDR).

Provisional hypothesis formulation of these variables is as follows:

H3: Third Party Funds (DPK) affects Loan to Deposit Ratio (LDR)

Relationship of Loan to Deposit Ratio (LDR) to Return on Assets (ROA)

According to Nusantara (2009) the higher the LDR shows the higher the funds disbursed and the lower the LDR shows the lack of effectiveness of banks in lending.

Research conducted by Kasbal (2011), Ramdany (2012), Agustiningrum (2013) shows that LDR has a positive effect on profitability. The same results with research according to Dewi, Herawati, & Sulindawati (2015) that the Loan to Deposit Ratio (LDR) affects profitability either partially or simultaneously.

Provisional hypothesis formulation of these variables is as follows:

H4: Loan to Deposit Ratio (LDR) affects Return on Assets (ROA)

Relationship of Capital Adequacy Ratio (CAR) to Return on Assets (ROA).

The higher the CAR, the better the bank's ability to bear the risk of any risky productive credit/assets. If the CAR value is high, the bank is able to finance operational activities and make a significant contribution to profitability (Dendawijaya, 2009).

The results of research conducted by Mawardi (2005), Nusantara (2009), Bilal (2013), Wityasari (2014), Sudiyanto & Suroso (2010) show that CAR has a positive effect on profitability (ROA).

Provisional hypothesis formulation of these variables is as follows:

H5: Capital Adequacy Ratio (CAR) affects the Return on Assets (ROA).

Relationship of Prime Lending Rate (SBDK) to Return on Assets (ROA).

Based on the results of Kurniawati's research (2012), lending and interest rates together with have a significant effect on profitability (ROA). The magnitude of the effect of lending and interest rates on profitability (ROA) is 19.9% in a positive direction, while the remaining 80.1% is influenced by other factors outside this study.

Provisional hypothesis formulation of these variables is as follows:

H6: Prime Lending Rate (SBDK) affects the Return on Assets (ROA).

Relationship of Third Party Funds (DPK) to Return on Assets (ROA).

Sudiyanto (2010) examined DPK using time series data on a sample of banks listing on the IDX and concluded that Third Party Funds had a significant effect on bank profitability. While Nasution (2011), Anggreni & Suardika (2014), and Permatasari (2017) who conducted research on state-owned banks in Indonesia also produced findings that Third Party Funds had a positive and significant effect on ROA.

Provisional hypothesis formulation of these variables is as follows:

H7: Third Party Funds (DPK) affect the Return on Assets (ROA).

Relationship of Capital Adequacy Ratio (CAR) to Return on Assets (ROA) through the mediation of Loan to Deposit Ratio (LDR).

According to the Indonesian economic report, the main source of profit of a bank is obtained from the distributed credit. The amount of credit extended will determine bank profits (Kasmir, 2014). Banks that have a high CAR will also have a lot of credit, so if CAR increases it will increase the LDR (Nandadipa, 2010).

The reverse results in the study of Wityasari & Pangestuti (2014) that from the mediation test with the Sobel test found that CAR does not have an indirect effect on ROA through LDR, in other words, LDR variables cannot mediate between the independent variable (CAR) and the dependent variable (ROA). Similar to the results of research conducted by the Pangestika (2018) shows that the variable Loan to Deposit Ratio (LDR) was not found to mediate the effect of Capital Adequacy Ratio (CAR) on Return On Assets (ROA).

So that the hypothesis can be drawn as follows:

H8: Capital Adequacy Ratio (CAR) has no effect on Return on Assets (ROA) through the mediation of the Loan to Deposit ratio (LDR).

Relationship of Prime Lending Rate (SBDK) to Return on Assets (ROA) mediated by the Loan to Deposit Ratio (LDR).

In the business world will certainly affect if interest rates rise, namely in sectors that rely on financing from loans (credit). When there is an increase in credit interest, the value of the customer's business is not proportional to the financing provided and the customer objects to a high-interest rate, hence the occurrence of bad credit that will affect the bank's profit. (Syaichu & Wibowo, 2013).

So the temporary hypothesis is as follows:

H9: Prime Lending Rate (SBDK) affects the Return on Assets (ROA) mediated by the Loan to Deposit Ratio (LDR).

Third-Party Funds (DPK) affect the Return on Assets (ROA) mediated by the Loan to Deposit Ratio (LDR).

An increase in third party funds will result in credit growth, therefore the growth of DPK has a positive effect on LDR (Nandadipa, 2010). Research conducted by Harmanta & Ekananda (2005), Meydianawati (2006), Pratista (2010) produced a positive and significant DPK influence on LDR. The lower LDR shows the lack of effectiveness of banks in lending so that banks lose the opportunity to make a profit (ROA) (Rusdiana, 2012).

So from the above studies, hypotheses can be built as follows:

H10: Third Party Funds (DPK) affect the Return on Assets (ROA) mediated by the Loan to Deposit Ratio (LDR)

III. RESEARCH METHODS

III.1 RESEARCH METHODS

The object of this study is the Banking Companies listed central bank of Indonesia (BI), which has published a financial report in financial service authority (OJK) Period 2009 - 2018. Types of data used in this study are secondary data, namely in the form of panel data for all related variables. The population in this study is banking with a total of 50 companies.

Based on sample selection, the total sample of BI listed that meets the criteria is 5 companies listed on OJK in 2009-2018.

III.2. POPULATION AND SAMPLE

The population in this study is conventional commercial banks whose existence is directly monitored by the OJK, especially those included in the Commercial Banks Business Activity (BUKU) IV group with a total of 5 banks, from 2009 to 2018. Sampling using the cluster sampling method based on bank groups as the following:

1. Conventional commercial banks that are included in the BUKU IV group are published in the OJK for the period of 2009 to 2018.
2. Conventional commercial banks that have financial statement data available during the study period from 2009 to 2018.

III.3 METHOD OF ANALYSIS

In this study, the analysis method is carried out by path analysis which is a development of the regression model. Through this path analysis, the regression equation involves independent and dependent variables by testing intervening variables. Path analysis can also measure the relationship between variables in the model both directly and indirectly.

III.4. DEFINITION ON OF OPERATIONAL VARIABLES

Dependent Variables

The definition of operational variables is very important in research. This is intended to avoid misunderstandings or differences in perceptions regarding the data to be collected. In this study Return On Assets are used as dependent variables.

Return On Assets is a ratio used to measure a company's ability to generate profits.

Independent Variables

Capital Adequacy Ratio (CAR)

Capital Adequacy Ratio is the ratio of the adequacy of capital owned by banks to support assets that contain or generate risk, for example, loans granted.

Prime Lending Rate (SBDK)

Prime Lending Rate (SBDK) is a price that must be paid by debtors to banks for loans that have been given. For banks, the loan interest rate is the selling price that will be charged to debtors.

Third-Party Funds (DPK)

Third-Party Funds (DPK) are funds obtained from the community, in the sense of the community as individuals, companies, governments, households, cooperatives, foundations, etc. both in rupiah and in foreign currencies.

Intervening Variable

Loan to Deposit Ratio (LDR) is the ratio between the total volume of credit extended by banks and the number of funds received from various sources. LDR is the company's financial ratio related to liquidity.

III.5. DATA ANALYSIS

The analysis technique used in this study is path analysis. Before the path analysis is carried out, the assumption of path analysis must first test. The test consists of normality, multicollinearity, and heteroscedasticity. The path analysis model is as follows:

Substructure Equation 1:

$$Z = \rho_{zx1} x_1 + \rho_{zx2} x_2 + \rho_{zx3} x_3 + \epsilon_1$$

Substructure Equation 2:

$$Y = \rho_{yx1}.X_1 + \rho_{yx2}.X_2 + \rho_{yx3}.X_3 + \rho_{yz}.Z + \epsilon_2$$

Based on the literature review and strengthened by previous research it is suspected that variables such as CAR, SBDK, and DPK directly influence LDR and LDR also directly influences ROA. It is also assumed that CAR, SBDK, and DPK indirectly influence ROA which is mediated by the LDR variable. Thus the writer can formulate the research framework as follows:

Figure 1: Framework for Research Models

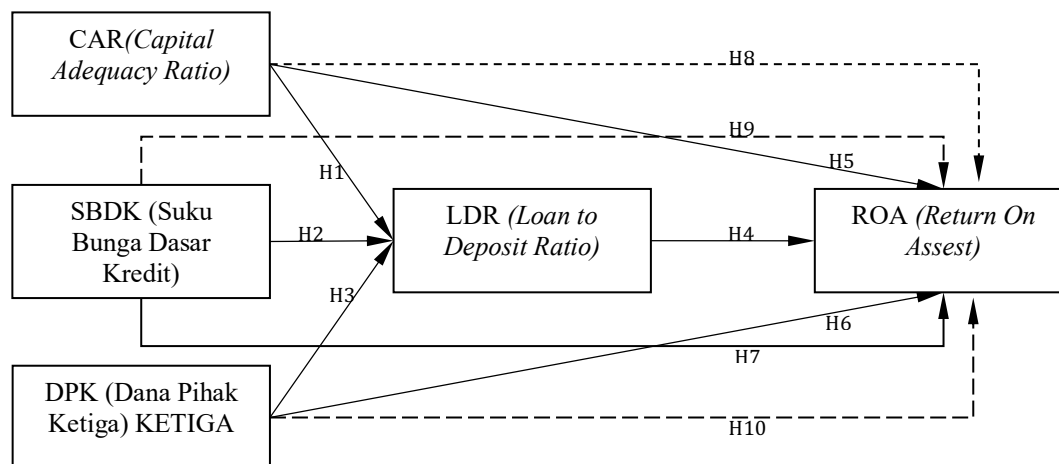

IV. RESULTS AND DISCUSSION

Before conducting statistical analysis, the data to be processed first must meet the regression analysis assumptions (Ghozali,2013).

TESTING OF THE REGRESSION ANALYSIS ASSUMPTION AND RESULT

Substructure Equation 1:

Before conducting statistical analysis, the data to be processed first must meet the regression analysis assumptions.

Table 4. One-Sample Kolmogorov-Smirnov Test

		Unstandardized Residual
N		50
Normal Parameters ^{a,b}	Mean	.0000000
	Std. Deviation	9.23691499
Most Extreme Differences	Absolute	.152
	Positive	.066
	Negative	-.152
Kolmogorov-Smirnov Z		1.075
Asymp. Sig. (2-tailed)		.198

a. Test distribution is Normal.

b. Calculated from data.

In table 4 above, the Asymp value is obtained. Sig (2- tailed) of 0.198 or can be written as a probability value (P-value) = 0.198 > 0.05 or Ho is accepted. Thus, residual data are normally distributed.

Table 5. Autocorrelation Test (Durbin- Watson) Model Summary

Model	R	R Square	Adjusted R Square	Std. Error of the Estimate	Durbin-Watson
1	,564 ^a	,318	,274	9,53336	,398

Source: data processed

From Table 5 above, the results of autocorrelation with Durbin - Watson are 0.398, which means that the autocorrelation category does not occur because the D-W number is between -2 to 2 (Singgih, 2013).

Table 6. Tolerance dan VIF (Multicollinearity Test)

Model	Collinearity Statistics	
	Tolerance	VIF
1 (Constant)		
CAR	.418	2,391
SBDK	.652	1,533
DPK	.465	2,149

Source: data processed

Based on the results of testing the tolerance value (see Table 6 above) also shows that there is no independent variable that has a tolerance value below or less than 0.10, which means that there is no correlation between the independent variables whose value is more than 95%. The results of the calculation of Variance Inflation Factor (VIF) also showed the same results, namely, there are no independent variables that have a VIF value >10. So it can be said and concluded that there is no multicollinearity between the independent variables in the regression model.

Figure 2: Scatterplot graph (Heteroscedasticity Test)

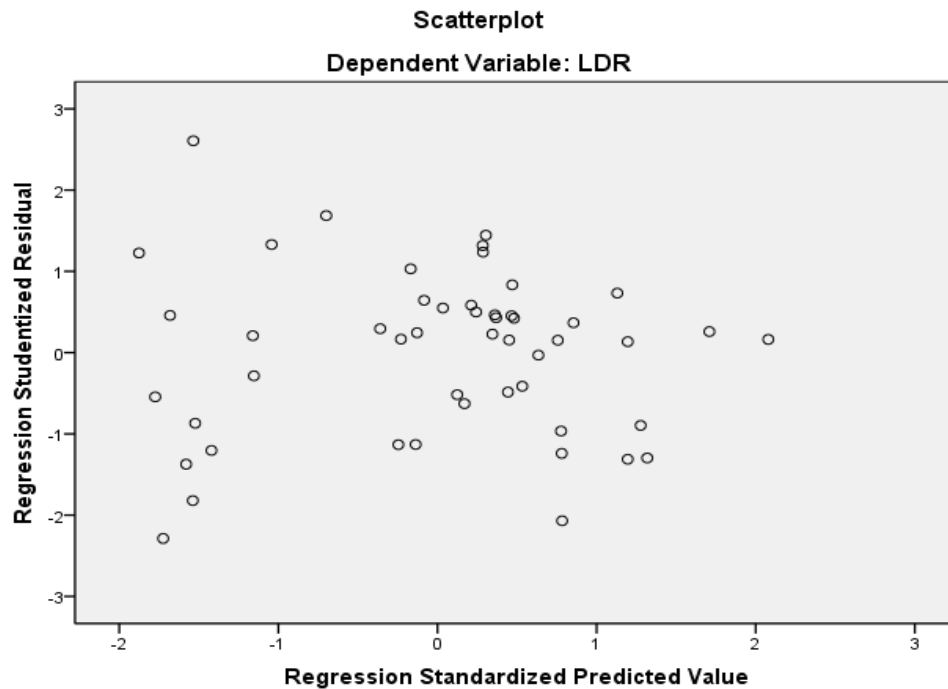

Based on Figure 2 above, there is a scatterplot graph that shows the points of diffuse and does not form certain clear patterns. So it can be concluded that there are no symptoms of heteroscedasticity.

Table 7. Summary of Results: Substructure Equation 1

Model	Standardized Coefficients	t-test Sig	Description	F-test and Sig.	R-Square
CAR → LDR	.339	.078	Significant	0,000	0,318
SBDK → LDR	-.493	.002	Significant		
DPK → LDR	-.386	.036	Significant		

Table 7 above is a summary table for substructural model equations 1. The data information contained in table 7 is derived from the processing of multiple regression analysis data. Table 7 will be used to assess whether the substructural 1 equation model is good enough (fit model) or not. Then the results in table 7 will be used to see the direct or non-direct effect on ROA in Figure 4.

Based on the table, the substructural 1 equation model is considered to be quite good (fit model) because all the independent variables (CAR, SBDK, and DPK) are significant. The R-squares are quite moderate. So overall the substructural 1 equation model and its coefficient information are valid and unbiased. Therefore we can draw conclusions using the data in table 7. Furthermore, the results can be used for the path analysis that is the basis of this research analysis (see Figure 4).

Substructure Equation 2:

Table 8. One-Sample Kolmogorov-Smirnov Test

		Unstandardized Residual
N		50
Normal Parameters ^{a,b}	Mean	.0000000
	Std. Deviation	.74739162
Most Extreme Differences	Absolute	.074
	Positive	.070
	Negative	-.074
Kolmogorov-Smirnov Z		.523
Asymp. Sig. (2-tailed)		.947

a. Test distribution is Normal.

b. Calculated from data.

In table 8 above, the Asymp value is obtained. Sig (2- tailed) of 0.947 or can be written as a probability value (P-value) = 0.947 > 0.05 or Ho is accepted. Thus, residual data are normally distributed.

Tabel 9. Autocorrelation Test (Durbin- Watson) Model Summary

Model	R	R Square	Adjusted R Square	Std. Error of the Estimate	Durbin-Watson
1	.660 ^a	.435	.385	.77990	.726

a. Predictors: (Constant), LDR, DPK, SBDK, CAR

b. Dependent Variable: ROA

From Table 9 above, it can be seen that the Durbin-Watson value is 0.726 in the autocorrelation free region because it is between -2 to +2. So the decision taken in the autocorrelation test is accepted Ho, reject H1. It means that this test does not contain an autocorrelation problem. Thus it can be concluded that the regression equation model is free from autocorrelation symptoms.

Tabel 10. Tolerance dan VIF (Multicollinearity Test)

Model	Collinearity Statistics	
	Tolerance	VIF
1 (Constant)		
CAR	.391	2,560
SBDK	.529	1,890
DPK	.422	2,367
LDR	.682	1,467

Source: data processed

Based on Table 10, the results of testing the tolerance value also shows that there is no independent variable that has a tolerance value below or less than 0.10, which means that there is no correlation between the independent variables whose value is more than 95%. The results of the calculation of Variance Inflation Factor (VIF) also showed the same results, namely, there are no independent variables that have a VIF value >10.

Figure 3: Scatterplot graph (Heteroscedasticity Test)

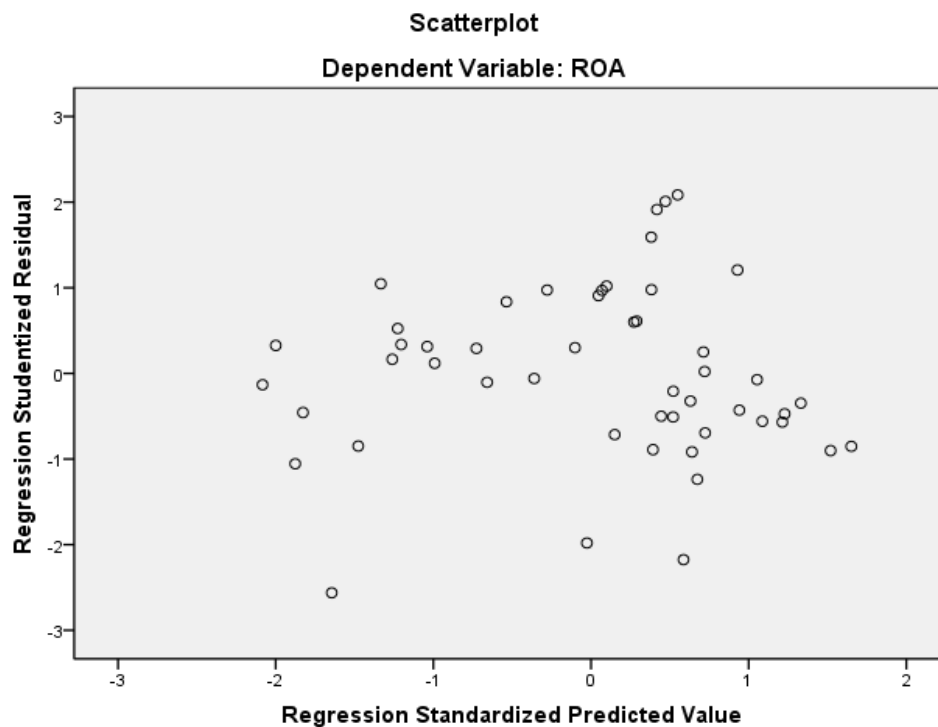

Based on Figure 3 above, there is a Scatterplot graph that shows the scattered points do not form a certain clear pattern. So it can be concluded that there are no symptoms of heteroscedasticity.

Table 11. Summary of Results: Substructure Equation 2

Model	Standardized Coefficients	t-test Sig	Description	F-test and Sig.	R-Square
CAR → ROA	-.458	.014	Significant	0,000	0,435
SBDK → ROA	-.166	.286	Not significant		
DPK → ROA	.732	.000	Significant		
LDR → ROA	-.337	.017	Significant		

Table 11 above is a summary table for substructural model equations 2. The data information contained in table 11 is derived from the processing of multiple regression analysis data. Table 11 will be used to assess whether the substructural 2 equation model is good enough (fit model) or not. Then the results in table 11 will be used to see the direct or non-direct effect on ROA in Figure 3.

Based on the table, the substructural 2 equation model is considered to be quite fit because all the independent variables (CAR, DPK, and LDR) except SBDK are significant. SBDK not significant because SBDK has no effect on ROA because banks included in BUKU IV are not under the influence of the lure of the interest rate. Facilities in the form of good service are an attraction of this bank group. The R-squares are quite moderate. So overall the substructural 2 equation model and its coefficient information are valid and unbiased. Therefore we can draw conclusions using the data in table 11. Furthermore, the results can be used for the path analysis that is the basis of this research analysis (see Figure 4).

Figure 4: Coefficient of Path Analysis

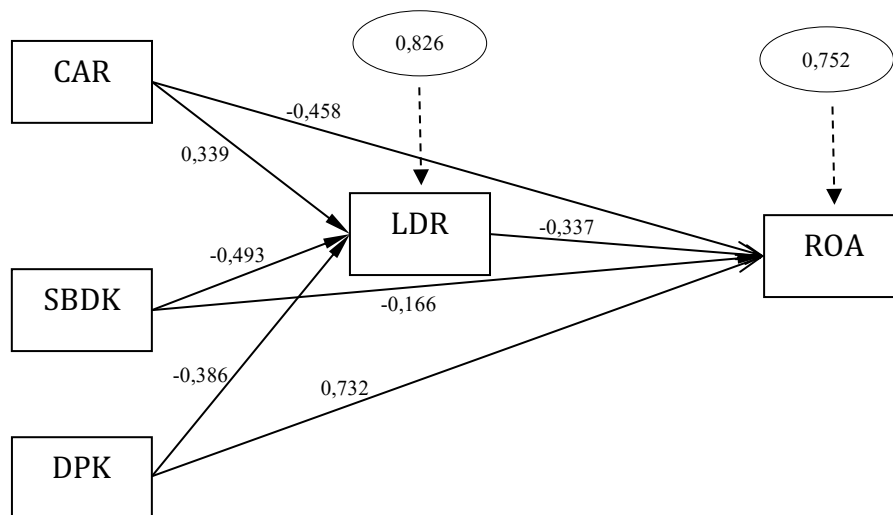

Source: data processed

The path coefficient interpretation is as follows:

- Effect of CAR on ROA :
 - Direct influence = -0,458
 - Indirect influence (through LDR) = $0,339 \times -0,337 = -0,114$
 - Total influence = $-0,458 + (-0,114) = -0,572$
- Effect of SBDK on ROA:
 - Direct influence = -0,166
 - Indirect influence (through LDR) = $-0,493 \times -0,337 = 0,166$
 - Total influence = $-0,166 + 0,166 = 0,000$
- Effect of DPK on ROA
 - Direct influence = 0,732
 - Indirect influence (through LDR) = $-0,386 \times -0,337 = 0,130$
 - Total influence = $0,732 + 0,130 = 0,862$
- The effect of LDR on ROA = -0,337

The above results are summarized in Table 12. Table 12 will be able to show the role of each variable influencing the ROA and the role of LDR as an intervening variable.

Table 12. Summary of the Value of Direct Effects, Indirect Effects and Total Effects Between Variables

Influence of Variables	Direct influence	Indirect influence (through LDR) : Intervening variable	Total influence
CAR (X1) → ROA (Y)	-0,458	$0,339 \times -0,337 = -0,114$	$-0,458 + -0,114 = -0,572$
SBDK (X2) → ROA (Y)	-0,166	$-0,493 \times -0,337 = 0,166$	$-0,166 + 0,166 = 0,000$
DPK (X3) → ROA (Y)	0,732	$-0,386 \times -0,337 = 0,130$	$0,732 + 0,130 = 0,862$
LDR (Z) → ROA (Y)	-0,337	-	-0,337
CAR (X1) → LDR (Z)	0,339	-	0,339
SBDK (X2) → LDR (Z)	-0,493	-	-0,493
DPK (X3) → LDR (Z)	-0,386	-	-0,386

Source: data processed

Based on the above calculation Table 12, it can be concluded as follows:

1. Capital Adequacy Ratio has an indirect effect on Return On Assets, from the calculation results that the direct effect of -0.458 is smaller than the indirect effect - 0.114 (through LDR). Because CAR to ROA directly has no significant effect based on table 8. So it is better to influence CAR on ROA through LDR (intervening variable) than directly. This means that CAR in influencing ROA through LDR can be seen LDR as an intervening variable and here plays a role in increasing ROA. This role is due to LDR policy improving capital management (CAR). So that the overall total CAR effect on ROA increases when managing LDR better.
2. Prime Lending Rate (SBDK=X2) has an indirect effect on Return On Assets, from the results of calculations that the direct effect of -0.166 (lowers ROA). But the indirect effect of 0.166 (through LDR). This path also shows that LDR acts as an intervening variable from SBDK to ROA. Like the CAR to ROA path. SBDK has an effect on increasing ROA through the policy of LDR. So here the role of LDR as an intervening variable between SBDK and ROA is clearly seen because it increases ROA. The role of LDR has also been shown in the upper path between the influence of CAR on ROA through LDR. LDR here shows its role in reducing smaller ROA decreases due to an increase in SBDK when there is LDR as an intervening variable.
3. Third-Party Funds (DPK) has a direct effect on Return On Assets, from the calculation results that the direct effect of 0.732, and this increase in ROA will increase if the bank applies LDR. The addition of ROA due to DPK (through LDR) is 0.130. So that overall ROA increases higher than not applying a good policy of LDR. In the conception of credit/financing management, third party funds (DPK) is the basis for decisions or policies in the Bank. If DPK in a stable condition, then this will provide a degree of certainty decision in granting credit. Because of the increase, DPK lending decisions will be even higher. DPK influential was positive towards Credit Distribution. When funds are collected from high society, then the decision to extend credit will be increasingly too high.
4. The role of LDR can improve ROA. And that role can be seen by comparing the direct influence of each variable and indirectly through intervening. By intervening in a good policy of LDR, the effect of through good policy of LDR is higher than aggressive LDR. This shows that LDR has a role in increasing ROA due to changes in CAR, SBDK, and DPK variables. This means that if a bank wants to increase profits, not only loans, bad loans and capital should be considered, but the Loan to Deposit Ratio must also be maintained.

V. CONCLUSION

Based on the results of statistical tests obtained after data collection, data processing, hypothesis testing, and analysis and discussion related to the research hypothesis, the researcher draws the conclusions as follows:

1. Partially the independent variables in this study affect the intervening variable (LDR).
2. Partially all the independent variables affect the dependent variable (ROA) except the SBDK variable which does not show influence.
3. Independent variables except DPK show an indirect effect on the dependent variable (ROA) through mediating the intervening variable (LDR).

VI. RECOMMENDATION

Based on the results of research and discussion, there are several suggestions that can be given, including:

1. For bank BUKU 4 (which is a sample), it must be prudent to manage its credit (LDR) because this variable is proven in this study as an intervening variable that mediates the influence of Capital (CAR), Third-Party Funds (bank deposits) and bank interest (Prime Lending Rate) on profit achievement (ROA) bank.
2. CIMB NIAGA as a new member in the BUKU IV bank group, as a "new child" has the smallest ratio numbers among other old BUKU IV members. Core capital is also at the threshold of entry requirements in the BUKU IV group, as well as the average annual profit being the smallest. For this reason, it is recommended that CIMB NIAGA be able to increase the ratio, profit, and core capital figures so that they do not "downgrade" from the BUKU IV bank group.
3. For the community as the owner of the funds, if they want to channel their funds to the bank in the form of investments or deposits in order to consider important variables that influence the bank where the investment

is to achieve optimal profits. And for people who need funds from banks to be wiser in making decisions to receive credit or loans from banks.

4. For future researchers, it is better to include other independent variables that contribute more to the bank's profitability variables, such as core capital variables (with regard to size), external factors (economic and political).

References

- Undang-undang Republik Indonesia No. 10 tahun 1998 tentang Perubahan atas Undang-undang no. 7 tahun 1992 tentang Perbankan. (1998). *Presiden Republik Indonesia*.
- Aji, T. W., Susyanti, J., & Slamet, A. R. (2017). Pengaruh Suku Bunga Kredit, Risiko Kredit dan Kecukupan Modal terhadap Profitabilitas. *e – Jurnal Riset Manajemen Prodi Manajemen, Fakultas Ekonomi Unisma*, website : www.fe.unisma.ac.id (email : e.jrm.feunisma@gmail.com).
- Anggreni, M. R., & Suardhika, I. S. (2014). Pengaruh Dana Pihak Ketiga, Kecukupan Modal, Risiko Kredit dan Suku Bunga Kredit pada. *ISSN: 2302-8556 E-Jurnal Akuntansi Universitas Udayana*. 9.1, 27-38 .
- Aryaningsih, N. (2008). Pengaruh suku bunga, inflasi, dan jumlah penghasilan terhadap permintaan kredit di PT. BPD Cabang Pembantu Kediri. *Lembaga Penelitian Undiksha : Jurnal penelitian dan pengembangan sains dan humaniora*.
- Baihaqi, B. (2017, Nopember 23). *Tingkat Profitabilitas Perbankan Terus Menurun*. Retrieved from *Harian Ekonomi Neraca*: <http://www.neraca.co.id/article/93427/tingkat-profitabilitas-perbankan-terus-menurun>
- Bank Indonesia, D. (2011). Penilaian Tingkat Kesehatan Bank Umum. *Surat Edaran Bank Indonesia (SE BI) No.13/ 24 /DPNP*. Jakarta, Indonesia: Bank Indonesia.
- Bank, I. (2013, Januari 15). Transparansi Informasi Suku Bunga Dasar Kredit. *Surat Edaran Bank Indonesia (SEBI) no. 14/1/DPNP*. Jakarta, Jakarta, Indonesia: Bank Indonesia.
- Boediono. (2014). *Seri Sinopsis Pengantar Ilmu Ekonomi no. 5 Ekonomi Makro*. Yogyakarta: BPFE.
- Brigham, & Houston. (2010). *Dasar-dasar Manajemen Keuangan, Buku I, Edisi II*. Jakarta: Salemba Empat.
- Budiawan. (2008). Analisis Faktor - Faktor yang Mempengaruhi Penyaluran Kredit pada Bank Perkreditan Rakyat (Studi Kasus pada BPR di Wilayah Kerja BI Banjarmasin). *Tesis Program Studi Magister Manajemen Universitas Diponegoro Semarang*.
- Christiano, M., Parengkuan, T., & Saerang, I. (2014). Analisis Terhadap Rasio-rasio Keuangan untuk mengukur Profitabilitas pada Bank-bank Swasta yang Go Public. *Jurnal EMBA Vol.2 No.4 Desember*, 817-830.
- Darmawi, H. (2011). *Manajemen Perbankan*. Jakarta: Bumi Aksara.
- Dendawijaya, L. (2009). *Manajemen Perbankan*. Jakarta: Ghalia Indonesia.
- Dewi, L. E., Herawati, N. T., & Sulindawati, E. L. (2015). Analisis Pengaruh NIM, BOPO, LDR, DAN NPL terhadap Profitabilitas (Studi Kasus Pada Bank Umum Swasta Nasional Yang Terdaftar Pada Bursa Efek Indonesia Periode 2009-2013). *e-Journal SI Ak. Universitas Pendidikan Ganesha Jurusan Akuntansi Program SI (Volume: 3 No. 1)*.
- Fahrana, H. (2018). Fkator-faktor yang Pengerahui Penyaluran Kredit pada Bank Umum Swasta Nasional Devisa di Indonesia. *Jurnal Ekonomi Daerah (JEDA) Vol 8, No 1 (2020)* .
- Ferdinand, A. (2014). *Metode Penelitian Manajemen*. Semarang: BP Universitas Diponegoro.
- Ghozali, I. (2013). *Aplikasi AnalisisMultivariate dengan Program IBM SPSS 21Update PLS Regresi*. Semarang: Badan Penerbit Universitas Diponegoro.
- Gubernur Bank Indonesia. (2012). Tentang Kegiatan Usaha dan Jaringan Kantor Berdasarkan MOdal Inti Bank. *Peraturan Bank Indonesia Nomor 14/26/PBI/2012*.
- Gudono. (2012). *Analisis Data Multivariate. Edisi 2*. Yogyakarta: BPFE.
- Hamidah, Goldan, S. M., & Mardiyati, U. (2014). Analisis Pengaruh LDR, NPL dan Operational Efficiency Ratioterhadap Return On Assets pada Bank Devisa di Indonesia periode 2010-2012. *Jurnal Riset Manajemen Sains Indonesia (JRMSI) | Vol. 5, No. 1*.
- Harjito, A., & Martono. (2010). *Manajemen Keuangan*. Yogyakarta: Ekonosia.
- Haryoso, P., & Kusdiasmo, B. (2016). Capital Adequacy Ratio (CAR) dan Dana Pihak Ketiga (DPK) terhadap Return On Asset (ROA) dengan Penyaluran Kredit sebagai Variabel Intervening. *Advance Vol.4 No.1 Edisi Maret 2016, ISSN 2337 - 5221*.
- Hasanudin, & Prihatiningsih, M. (2010). Analisis Pengaruh Dana Pihak Ketiga Tingkat Suku Bunga kredit Non Performing Loan (NPL) dan Tingkat Inflasi terhadap penyaluran Kredit Bank Perkreditan Rakyat (BPR) di Jawa Tengah. *Politektik Negeri Semarang, 5(1)*, 25-31.
- Hersugondo, & Tamtomo, H. S. (2012). Pengaruh CAR, NPL, DPK, dan ROA terhadap LDR Perbankan Indonesia. *Dharma Ekonomi. Vol.XIX, No.36, Oktober*.
- Idroes, F. (2008). *Manajemen Resiko Perbankan*. Jakarta: PT. Raja Grafindo Persada.

- Ismail. (2013). *Manajemen Perbankan. Edisi Pertama*. Jakarta: Kencana.
- Judisseno, R. K. (2002). *Sistem Moneter Dan Perbankan Di Indonesia*. Jakarta: PT Gramedia Pustaka Utama.
- Kasmir. (2014). *Bank dan Lembaga Keuangan Lainnya, Edisi Revisi*. Jakarta: Raja Grafindo Persada.
- Kieso, D. E., Jerry, J. W., & Terry, D. (2007). *Akuntansi Intermediete, Terjemahan Emil Salim, Jilid 1, Edisi Kesepuluh*. Jakarta: Erlangga.
- Kontan, H., & Adi, T. (2019, Maret 28). *Struktur dan kinerja perbankan Indonesia*. Retrieved from Kontan.co.id: <https://analisis.kontan.co.id/news/struktur-dan-kinerja-perbankan-indonesia>
- Kuncoro, M., & Suhardjono. (2011). *Manajemen Perbankan*. Yogyakarta: BPFE.
- Lokollo, N. G. (2018). Pengaruh Dana Pihak Ketiga (Dpk), Dan Non Performing Loan (Npl) Terhadap Loan To Deposit Ratio (Ldr) Dan Dampaknya Pada Profitabilitas (Studi Pada Bank Pertanian Di Asia Tenggara Dan Asia Timur). *Masters thesis, Universitas Pamulang*, <http://eprints.unpam.ac.id/id/eprint/7254>.
- Mishkin, F. S. (2008). *Ekonomi Uang, Perbankan, dan Pasar Keuangan, Edisi 8*. Jakarta: Salemba Empa.
- Munawir. (2007). *Analisis Laporan Keuangan*. Yogyakarta: Liberty.
- Munawir, S. (2010). *Analisa Laporan Keuangan*. Yogyakarta: Liberty.
- Nandadipa, S. (2010). Analisis Pengaruh CAR, NPL, Inflasi, Pertumbuhan DPK., *Skripsi*.
- Novianto, A. (2011). Analisis Pengaruh Nilai Tukar (Kurs) Dolar Amerika/Rupiah (Us\$/Rp), Tingkat Suku Bunga SBI, Inflasi, dan Jumlah Uang Beredar (M2) terhadap Indeks Harga Saham Gabungan (IHSG) di Bursa Efek Indonesia (BEI) periode 1999.1–2010.6. *Undergraduate thesis*.
- Nugraha, R. E. (2014). Analisis Pengaruh CAR, NPL, BOPO, ROA, dan NIM terhadap LDR(Studi Empiris Pada Perbankan Syariah Di Indonesia Periode 2010-2012). *Naskah Publikas Universitas Muhammadiyah Surakarta*.
- Otoritas Jasa Keuangan. (2017). Retrieved from www.ojk.go.id: <https://www.ojk.go.id/id/kanal/perbankan/Pages/Bank-Umum.aspx>
- Otoritas Jasa Keuangan Republik Indonesia. (2016). Tentang Kegiatan Usaha dan jaringan Kantor Berdasarkan Modal Inti Bank. *Peraturan Otoritas jasa Keuangan Nomor 6/POJK.03/2016*.
- Pardede, D. N. (2016). Analisis Pengaruh CAR, Dana Pihak Ketiga (DPK), NIM, DAN LDR terhadap Profitabilitas Perbankan dengan LDR sebagai Variabel Intervening (Studi Pada Bank Umum Go Public di Indonesia Periode 2010-2014). *Skripsi*.
- Parenrengi, S., & Hendratni, T. W. (2018). PPengaruh dana pihak ketiga, kecukupan modal dan penyaluran kredit terhadap profitabilitas bank. *Jurnal Manajemen Strategi dan Aplikasi Bisnis, Vol 1, No.1*, 9 – 18.
- Prasanjaya, A., & Ramantha, I. (2013). Analisis Pengaruh Rasio CAR, BOPO, LDR dan Ukuran Perusahaan terhadap Profitabilitas Bank yang terdaftar di BEI. *E-Jurnal Akuntansi Universitas Udayana 4.1, ISSN: 2302-8556*, 230-245.
- Prayudi, A. (2012). Pengaruh Capital Adequacy Ratio (CAR), Non-Performing Loan (NPL), BOPO, Return On Asset (ROA) dan Net Interest Margin (NIM) terhadap Loan to Deposit Ratio (LDR). *Gunadarma University E-Paper*. <http://papers.gunadarma.ac.id/>.
- Purwanto, D. (2016, Januari 4). *CAR Perbankan Kurang dari 8% Harus Ditutup*. Retrieved from Oke Finance: <https://economy.okezone.com/read/2010/01/04/320/290796/car-perbankan-kurang-dari-8-harus-ditutup>
- Puspitasari, D. (2009). Analisis Pengaruh CAR, NPL, NIM, BOPO, LDR, dan Suku BUnga BI terhadap ROA. *Tesis Prodi Magister Manajemen Universitas Diponegoro*.
- Putra, A. P., & Anggoro. (2017). Pengaruh Suku Bunga SBI, CAR, LDR, ROA, dan NPL terhadap Penyaluran Kredit Modal Kerja (Studi Pada Perusahaan Perbankan Yang Terdaftar Di BEI Periode 2005 – 2010) . *Other thesis, UPN "VETERAN" YOGYAKARTA* <http://eprints.upnyk.ac.id/id/eprint/11093>.
- Rajagukguk, R. (2017, Nopember 2017). *LPS: Profitabilitas Perbankan Turun, Rasio Kredit Bermasalah Tinggi*. Retrieved from iNews.id - Finance: <https://www.inews.id/finance/bisnis/lps-profitabilitas-perbankan-turun-rasio-kredit-bermasalah-tinggi>
- Ratu Edo, D. S., & Wiagustini, N. P. (2014). Pengaruh Dana Pihak Ketiga, Non Performing Loan, dan Capital Adequacy Ratio terhadap Loan to Deposit Ratio dan Return On Asset pada sektor Perbankan di Bursa Efek Indonesia. *ISSN : 2337-3067 E-Jurnal Ekonomi dan Bisnis Universitas Udayana 3.11*, 650-673 .
- Retherford, R. D. (1993). *Statistical Models For Causal Analysis. Program on Population*. Honolulu, Hawaii: East-West Center.
- Retnadi, D. (2006). Perilaku Penyaluran Kredit Bank. *Jurnal Kajian Ekonomi*.
- Romadhoni, E. N. (2014). Analisis Pengaruh Capital Adequacy Ratio (CAR), Non Performing Loan (NPL), Biaya Operasional Pendapatan Operasional (BOPO), Return On Asset (ROA) dan Net Interest Margin (NIM) terhadap Loan to Deposit ratio (LDR). *Universitas Muhammadiyah Surakarta*.
- Sarwono, J. (2006). *Metode Penelitian Kuantitatif dan Kualitatif*. Yogyakarta: Graha Ilmu.
- Sharvina, A. (2017). Pengaruh Dana Pihak Ketiga (Dpk) Dan Capital Adequacy Ratio (Car) Terhadap Loan To Deposit Ratio (Ldr) Pada Pt. Bank Negara Indonesia (Persero)Tbk. <http://repository.ekuitas.ac.id/handle/123456789/456>.
- Siamat, D. (2005). *Manajemen Lembaga Keuangan. "Kebijakan Moneter dan Perbankan" edisi kesatu*. Jakarta: Fakultas Ekonomi Universitas Indonesia.

- Sinungan, M. (2000). *Manajemen Dana Bank*. Jakarta: Bumi Aksara.
- Sipahutar, M. A. (2007). *Persoalan-persoalan Perbankan Indonesia*. Jakarta Pusat: Gorga Media.
- Sitanggang, L. M., & Tendi. (2019, Pebruari 5). *Return on asset (ROA) dari bank BUKU III menyusut di tahun 2018 lalu*. Retrieved from Kontan.co.id: <https://keuangan.kontan.co.id/news/return-on-asset-roa-dari-bank-buku-iii-menyusut-di-tahun-2018-lalu>
- Sitorus, R. (2017, Desember 12). *Profitabilitas Perbankan Diproyeksikan Kian Tergerus*. Retrieved from Bisnis.com: <https://finansial.bisnis.com/read/20171212/90/717780/profitabilitas-perbankan-diproyeksikan-kian-tergerus>
- Sudirman, W. (2013). *Manajemen Perbankan – Menuju Bankir Konvensional yang Profesional*. Jakarta: Kencana Prenada Media Grup.
- Sugiyono. (2007). *Statistik Untuk Penelitian*. Bandung: CV. Alfabeta.
- Sunariyah. (2013). *Pengantar Pengetahuan Pasar Modal, Edisi 6*. Yogyakarta: UPP STIM YKPN.
- Syaichu, M., & Wibowo, S. E. (2013). Analisis Pengaruh Suku Bunga, Inflasi, CAR, BOPO, NPF. *Diponegoro Journal of Management Volume 2, Nomor 2, ISSN (Online): 2337-3792*, 01-10.
- Syamsudin, L. (2011). *Manajemen Keuangan Perusahaan*. Jakarta: Rajawali Pers.
- Van horne, J. C., & wachowicz, J. J. (2005). *Fundamental of Financial Management/Prinsip-prinsip Manajemen Keuangan (Edisi Kedua belas)*. Jakarta: Salemba Empat.
- Widiarti, A. W., Siregar, H., & Andati, T. (2015). The Determinants of Bank's Efficiency in Indonesia. *Bulletin of Monetary, Economics and Banking, Volume 18, Number 2*.
- Wityasari, M., & Pangestuti, I. R. (2014). Analisis Pengaruh CAR, DANA PIHAK KETIGA (DPK), NPL, dan LDR terhadap Profitabilitas Perbankan dengan LDR sebagai Variabel Intervening. *Diponegoro Journal of Manajemen*, 01-14.
- Yanti, S. T., & Masdjojo, G. N. (2018). Pengaruh Capital Adequacy Ratio, Loan to Deposit Ratio, Net Interest Margin, dan Non Performing Loan terhadap Profitabilitas pada Bank Umum Swasta Nasional Devisa periode 2013-2017 . *Dinamika Akuntansi, Keuangan dan Perbankan, Vol. 7, No. 2*, 173 - 185 .
- Yudistira, G., & Dupla, K. (2017). *LPPI ungkap persoalan di perbankan Indonesia*. Retrieved from Kontan.co.id: <https://keuangan.kontan.co.id/news/lppi-ungkap-persoalan-di-perbankan-indonesia>
- Yudistira, G., & Kartika, H. (2018, Agustus 27). *Ini penyebab rasio profitabilitas bank swasta lebih rendah dari bank BUMN*. Retrieved from Kontan.co.id: <https://keuangan.kontan.co.id/news/ini-penyebab-rasio-profitabilitas-bank-swasta-lebih-rendah-dari-bank-bumn>
- Yuliani. (2017). Hubungan Efisiensi Operasional dengan Kinerja Profitabilitas pada Sektor Perbankan yang Go Publik di Bursa Efek Jakarta. *Jurnal Manajemen & Bisnis Sriwijaya Vol. 5 No. 10*.
- Zain, D. (2018). Riset Bisnis. <https://slideplayer.info/slide/12270081/>, (pp. 01-101).



Crime Treasure Islands: Tax Havens, Tax Evasion and Money Laundering

Michele Sabatino¹

¹ Assistant Professor, Department of Economics and Law Kore University of Enna, V.le delle Olimpiadi, Cittadella Universitaria, 94100 Enna, e-mail: michele.sabatino@unikore.it

Abstract

Globalization has encouraged the introduction of economic crime at the international level. Organized crime easily entered in legitimate activities through money laundering operations. In this context "tax havens" play an essential role in the globalization of financial crime. In these places, in fact, crime launders money coming from illegal activities and reinvests it in new activities. This paper intends to examine in depth the "chain" of illegal money with reference to "tax havens," starting from their definition, and detecting the existing network between tax evasion, money laundering and reinvestment in lawful activities.

Keywords: Tax Haven, Tax Evasion, Laundering, Off-shore company

JEL: F38, H26, K14

1. Introduction

The increasing expansion of criminal phenomena within legal economic activities has enforced the awareness that an efficient policy against organized crime cannot be exclusively a matter of criminal law measures implementation, but new strategies have to be carried out, starting from the relationship between tax crimes and criminal organizations in its multiple angles.

In this regard, indeed, it should be pointed out that the relationship between the achievement of the wealth through criminal activities and the taxation of the earnings that come about from these activities, mainly, has been examined through a tax policy focused on the research of tax revenue and the repression of the phenomenon of evasion. The struggle against tax evasion is conceived as a way to "make revenue" and to reduce tax pressure on legal activities and citizens.

In a fast-changing world and in the perspective of finding new law enforcement strategies against the presence of criminal organizations in legal markets, it is useful to analyze, on one hand, the connection between money laundering and tax evasion, and, on the other, it is necessary to make efforts and use resources, at different levels, national and international, in order to battle the so called "tax havens."

The world economic scenario, although constantly evolving, is, in fact, characterized by already integrated and highly competitive financial systems, with the presence of a widespread diffusion of banking and para-banking services aiming to offer on market appropriate operational instruments for several needs. This is the result both of the globalization of the economy and the extensive process of monetary liberalization with the consequent large fluctuation of assets at both national and transnational level, as well as with the advent of the internet. Moreover, in the intermediary sector, the international competition has solicited wide-ranging financial initiatives, at times ambitious and sophisticated, simultaneously concurrent cause and consequence of the interdependence of markets of different economies.

In this context, the organized crime easily entered in the legal market taking on the typical models of a company: the connection between the illegal and legal activities is exactly represented by money laundering, often put into practice through financial operations which generate evasion phenomena and tax elusion, both national and international. It is not by chance that the connection between money laundering and tax evasion has repeatedly been the focus of particular attention by the European Union, the OECD and the G20 countries, even if the action against money laundering and tax havens has not always been connected to the repression of crime organization, but rather to prevent the financing of terrorist organizations.

Several researches and investigations have, in fact, allowed to observe that "tax havens," carry out an essential function in the globalization of the activities related to financial crime because they ensure to their client's tax reliefs, banking secrecy and judicial immunity. Those criminal activities generate important profits, that subsequently can destabilize economic, industrial and financial sectors, in other words impeding both national and international policies. Criminal organizations take advantage and abuse of the discrepancies of the legislative, regulatory, legal and judicial systems. In this way they can prosper without being regulated by common laws to which legal activities must comply.

This paper, therefore, aims to analyze matters such as money laundering, tax evasion and elusion which through "tax havens" find the best way to avoid inspections and taxation of national States. These "sacred places," often represent the opportunity for crime to launder money that comes from illicit activities and reinvest it on legal ones. A proper "bleaching operation" of the assets with the advantage to be extremely confidential and devoid of any taxation. Therefore, while it is true, that tax havens are where it occurs one of the most form of inequality between wealth, citizens, taxed companies and wealth without any tax impositions, eluding the role of the national State as an equalization instrument, also, these places are where criminal organizations are strengthened (and nowadays we can even talk about terroristic organizations) becoming transnational and able to reinvest the huge and illicit assets in legal companies.

2. Definition and business

According to the most common definition "tax havens" are those Countries or territories with lower taxation or where, as it often happens in many cases, it is not applied any taxation¹. The aim of these tax havens is to attract non residents companies or natural persons, in order to let them start commercial activities or move their assets, avoiding or bypassing the regulations of their Countries where they actually carry out their activities. The expression "haven or off-shore financial center" is related to islands such as Cayman or Bahamas, and the states of the hinterland such as Switzerland (Tab 1). Actually we are referring to offshore activities when a subject resident in a country – more or less falsely - holds assets or domiciles the business in another Country in order to benefit of tax breaks. One of the peculiarity of many tax havens is the secrecy or opacity that guarantees the anonymity of the subjects that own financial activities and commercial companies.

¹ There are several definitions of "tax haven." According to the OECD, in the strict sense, they are those countries with no or only nominal income tax, which do not exchange information on tax matters with other countries, which are characterized by substantial financial opacity and do not require, for the purposes of residence, the requirement for the exercise of the effective activity on the national territory. Many countries with no or only nominal taxation, but which declare tax cooperation with other states, are therefore not included in the tax havens list in the strict sense. Below a broader concept of tax haven will be used, as in the aforementioned text of Zucman. For defining and methodological aspects, see: M. CARBONE, M. BOSCO, L. PETESE, The geography of tax havens, IPSOA Manuals, Wolters Kluwer, Milan, 2015. See also: M. GARA, P. DE FRANCESCIS, Tax havens: operational characteristics, empirical evidence and financial anomalies, Bank of Italy, Financial Information Unit for Italy, anti-Money Laundering notebooks, n. 3, 2015.

The way these territories or states work is relatively simple, although each of them is regulated by a specific legislation. Many banks receive money coming from all over the world – without any preclusion related to the identity of the owners often requesting moderate bank charges compared to those applied by others credit institutions. In this way they can let money "work" legally on international financial markets, and clients cannot have the obligation to justify the origin of their capitals. The protection of the anonymity is guaranteed. Therefore these places are far from being little faraway lands, rather the off-shore areas are represented by a geography that closely corresponds to the main centers of the economic activity: United States, Europe, Asia.

Table n. 1 – The main tax havens

Tax havens	Under the administration of:	Offered services
City of London	Great Britain	<ul style="list-style-type: none"> • On the tax front, rates of 5% and 1% and numerous legal loopholes • Administrative facilities in corporate management • Taxes on natural persons are very favorable and often insignificant, with the acquisition of the status of “resident not domiciled” it is possible to benefit of the taxation of incomes produced only in the United Kingdom.
Jersey, Guernsey, Isle of Mann, Cayman Islands, British Virgin Islands, Turk Islands, Caicos, Bermuda, Bahamas, Anguilla, Antigua and Barbuda, Belize	Great Britain	They refer to the tax system of Great Britain
Delaware	United States of America	<ul style="list-style-type: none"> • Among the best off-shore state in the world for secrecy and low taxation • Under the tax profile, very low taxation on companies incomes and profits
Switzerland	Switzerland	<ul style="list-style-type: none"> • Absence of obstacles to international capital transfers • Fiscally it is a state with a strong competitive regime • Banking secret is protected by the art. 28 c.c swiss, art. 27 federal banking law and art. 23-ter federal banking law
The Principality of Liechtenstein	Switzerland	Banking secrecy is guaranteed by strict rules
The Grand Duchy of Luxembourg	Luxembourg	<ul style="list-style-type: none"> • Extremely favorable tax laws with a net cut of 80% of taxable income • absence of withholding tax • banking secrecy
Netherlands and Netherlands Antilles	Netherlands	<ul style="list-style-type: none"> • Tax exemption on income flows to other jurisdictions in exchange for very low charges
The Principality of Monaco	The Principality of Monaco	<ul style="list-style-type: none"> • Tax system based on indirect withdrawals • no taxation for those who acquire the status of a Monegasque citizen

Singapore	Great Britain	<ul style="list-style-type: none"> • Bureaucracy is next to nothing for entrepreneurs • common law is the legal system
Other European Tax havens		Ireland, Cyprus, Malta, Principality of Andorra, Gibraltar, Vatican, San Marino
Other tax havens of the United States of America		Nevada, Wyoming, Panama, Marshall Islands, US Virgin Islands
Oceania Tax Havens		Narau, Niue, Samoa, Tonga, Vanuatu, Cook Islands
Asia tax havens		Malaysia, the Philippines, Brunei, Dubai, Saudi Arabia, Qatar, Kazakhstan, United Arab Emirates, Kuwait, Hong Kong.
African Tax havens		Lebanon, Seychelles, Liberia, Kenya, Mauritius, Ghana, Morocco, Tunisia, Somalia, Angola, Djibouti.

Source: our elaboration on the OECD (The Organization for Economic Co-operation and Development) data

According to the International Monetary Fund (FMI), seeing as the phenomenon of money laundering is between 2 and 5% of the global gross domestic product (GDP) and that half of international capital flows pass through or is kept in those territories, it is assumable that the money in circulation is between 600 and 1500 billions of Euro. In addition the financial wealth of families and companies is kept in these tax havens. Gabriel Zucman economist of Berkeley University of California, through a transparent methodology, has estimated, that 8% of financial capital of families is kept in these tax havens. The financial asset is the wealth kept by natural persons in bank accounts, in the shape of shares and obligations in mutual funds and insurance contracts, after deducing the debts. In 2014, this capital amounted, at the global level, 87.000 billions of Euro; 6.900 of this amount should be kept in open accounts in tax havens. Thirty percent 30% of off-shore assets, 2.100 billions are located in Switzerland. The rest is scattered among Singapore, Hong Kong, Bahamas, Cayman Islands, Luxembourg, and other tax havens that offer banking and financial services to Billionaires of all over the world. Where does the wealth kept in these tax havens come from? The main part of 2400 billions of euro comes from Europe, 1050 billions from United States and 1200 from Asia. The remaining part from other nations. In Europe, 10% of families financial assets is kept offshore, in the United States 4%. The percentages are higher in the emerging and developing Countries. In Africa, the wealth kept abroad is around 30%. In Russia and middle east oil-producing Countries is more than 50%.

Beyond the fact that companies or individuals that keep their assets in tax havens, are not obliged to pay taxes, or just a small part, these privileged areas carry out a remarkable role in the economy of developed countries. Not all tax havens offer the same level of advantages: some do not apply any taxation; others mainly agreed a tax exemption for the companies which keep their assets on their territories; others, instead, agreed to do not tax residents. Corporations take advantage from this situation, that seems, sometimes, to be deliberately studied for them. Whereas the tax evasion is one of the segments of the market of the offshore centers, these areas easily attract those who wish to avoid to pay taxes for their assets and incomes. The holders of large private assets, such as companies and corporations, are considered as privileged clients for these marketplaces. The money flow of these marketplaces has a central role in the system of global finance.

Because of their legal vacuum and the tolerance of large States, tax and financial havens accept many other activities. The money coming from corruption seeks refuge in tax havens, through a two ways system: it becomes possible to bring out illicitly, the money used for the corruption, and make the money resulting from corruption get back. Some security companies, larger providers of contractors and weapons for any local conflict, can seek refuge here in total discretion. In the end, for some time now, but recently with a strongly increasing, these countries give to merchant fleets a nationality called "of convenience," in other words "a shadow flag" in order to take advantage, in low tax conditions, of ships whose safety is extremely dubious.

In short, tax havens represent, therefore, a requisite increasingly significant for the global economy, especially with an impact on developing countries on the basis of four main modalities:

- the research from private and companies to find a way to considerably elude or reduce the payment of the taxes due to contribute to public finances;
- in fiscal terms transnational corporations have a relevant competitive advantage compared to national companies because they are more able than national ones to structure trade exchanges and investments through fictitious subsidiaries in territories with privileged taxation. The competition between them is unequal, no matter if local companies are technically more efficient or innovative than transnational competitors. Basically, big companies will be favored to the detriment of small ones, as well as those international compared to those national. Whereas in the developing countries most of the companies are smaller and more recent and focused on their inner dimension compared to those of developed countries, this tax system partiality will illegitimately favor transnational companies of industrialized countries to the detriment of internal competitor companies of developing countries;
- the opportunity of a safe coverage to launder the proceeds coming from political corruption, fraud, scam, illegal arms trade, drug trade, trough bank secrecy and trust services provided by globalized off-shore financial institutions. The lack of transparency of international financial markets contributes, in this way, to increase globalized crime, terrorism, corruption, as well as the embezzlement of resources from political and business elite;
- the instability of financial markets, mainly to the disadvantage of poor countries. Indeed, off-shore financial centers are used as a channel for rapid transfers of assets inside and outside national economies, destabilizing financial markets.

Trust, offshore companies, triangulation and creations of "international business companies" are some of the main tools provided for the potential clients of tax havens. Tricks and artifices are also related to accounting: normally, in case of evasion, clients keep an illegal accounting in an offshore server (a remote accounting that leaves no traces in the computer of the client). Sometimes it can be helpful the conventional regulation: a company that deals with trade of digital products on the web, for example, although it operates on a specific market, the server will be localized in a different country, with a privileged tax system, where this integrates stable organization, with a consequent attraction to a smaller imposition of incomes produced.

In this context, organized crime finds new fields to operate, assuming by now, the same specific peculiarities of a multinational enterprise, such as a significant liquidity, becoming in this way able both to compromise the economic system as a whole and to taint the business activities themselves (Becchi, Rey, 1994). Indeed tax and financial havens have a central role in the universe of illicit finance (assets that come from criminal and illicit activities), because they are "money laundering laboratories." These welcoming territories that launder and monetize dirty money of crime and corruption are the transparent prism through which the opacity of the illicit economy can be analyzed.

3. Tax evasion and elusion practices

The overview of tax havens is, therefore, quite complex and cannot immediately be identified because it is constantly evolving. The phenomenon, actually, seems to be increasing. In the last decade, during the financial crisis of 2007-2008, there was an increase of the so called "capital flight" towards tax havens. There are many people and several companies that try to hide their wealth completely or in part and mainly from public authorities (tax, financial, judicial, police). Usually it concerns incomes legally gained, but with the deliberate aim to escape from tax and social legislation: pay less taxes and hide profits. But on the other hand, it is about illicit incomes, came from arms trade, supply of mercenaries, drugs, prostitution, theft, racketeering, blackmail, smuggling and abuse of corporate assets.

Usually, within each national territory, these tax evasion and elusion practices occurred, taking the cue from legislative, administrative and judicial inadequacies. However these inadequacies have increasingly developed at the international level, also because of the lack of international organisms able to regulate, administrate and control, or rather exploiting the differences among national legislations. In a broad mobility condition of assets, disparities have turned into considerable advantages or disadvantages.

Tax elusion for multinationals occurs because of the gaps in the Law. In order to have an idea of its entity, we may consider that, in the United States, in 2013, companies made 650 billion of dollars of profits abroad. Half profits come from nations of a low or void tax imposition: Bermuda, the Netherlands, Luxembourg, Ireland, Singapore and Switzerland. The taxes evaded and eluded by corporations have been estimated, only for the United States, in 130 billions of dollars per year. Regarding 6900 billions of Euro of the assets that families keep in tax havens, according to Zucman, only 20% has been declared. The remaining 5.500 billions would escape, therefore, to taxation. The global loss of tax revenue amounts to 170 billion of euros, 30 for the United States and Asian countries, and 13 billion of euro for Africa.

Firstly this phenomenon is possible, through the suppression of currency controls and the free capital movements as well as the willingness of each State to attract mobile capital through articulated forms of *tax social and environmental dumping*. Moreover, this condition, takes advantage from recent technological developments: dematerialization of financial transactions; use of new means of communication; electronic currency transfers out of any control. In the end, the same evolution of the capitalism is the main cause of this trend: the creation of a single money market at the global level that let finance dominate all others economic sectors and to impose its influence on all human activities. The interconnections between bank systems and national financial markets have, therefore generated a global financial field. At the same time, national public authorities (Police, Justice, Revenue, Customs) actually remained, despite of many agreements and international conventions, confined within their respective national borders.

The developing of fraud and tax evasion is also the consequence, direct or indirect, of some political choices at the European level. Since 1992, governments of the European Union approved the total freedom of the circulation of assets without rapidly start a balancing process of tax systems and capitals and income taxation. This lack of balance, naturally pushed the owners of these assets to move them towards those European Union States which guarantee a low taxation. Recently this trend has crossed UE borders (even if some European Union States are real tax havens) involving other national entities that are specialized in these kinds of activities. The concern to attract mobile assets has brought about some States to adopt *tax dumping* policies. In order to finance national public expenditure, the tax burden on labour and income have been increased, extremely less mobile, causing an increase of internal social inequalities.

In the end, legal economy globalization has been followed by the globalization of criminal economy. Several criminal activities have been internationalized and their networks of relations have adopted a transnational logic. In the context of general economy, globalization through deregulation has facilitated also the integration of legal economy together with the criminal one causing serious social and economic consequences.

4. Money laundering

As already mentioned, criminal organizations easily break into the market assuming the characteristics of business activities where the connection between illicit and legal activities has been represented by money laundering, often through financial transactions connected to tax evasion and elusion. The tax evasion phenomenon and the money laundering coincide on the fact that they both locate illicit assets in tax havens. The interrelation between the legislation against money laundering and the one that aims at reducing the phenomenon of tax evasion it can be identified in the legislation of many OECD countries, which are progressively adapting their legislations to the measures identified by the FATF (International Financial Action Group) in the 49 recommendations, as well as the standards developed by the Global Forum on the subject of transparency and exchange of information on tax matters.

FATF has developed a model of laundering phenomenon, called “triphasic” because is composed by three phases:

- the first phase is represented by the *placement* of illicit assets, and it occurs through the introduction of these illicit capitals inside the financial system. The easiest and more common transaction consists to fractionate a significant amount of cash to obtain many little amounts, in order to make them less

- suspicious and more difficult to be identified when they are deposited on bank accounts;
- the second phase is the *layering* that consists, instead, in the subsequent movement of assets through a set of transactions (transfers, bank transfers, loans, payments) in order to hide the connection between the money and its illicit source. Practically it concerns to transfer these amounts on bank accounts of other marketplaces, particularly in those countries that do not collaborate with anti-money laundering inspections. These interbank transfers, therefore, start from the many bank accounts came about from the fractionated deposits and that are direct to a main collector account in an off-shore center. It is clear that uncontrolled electronic transfers facilitate these transactions;
 - in the last phase, in the end, called *integration*, financial resources are introduced in the legal economic cycle through investments in properties, luxury goods, companies or other. The introduction of funds in legal economic activities occurs through shell companies constituted in tax havens countries: real estate acquisitions; companies takeovers through stakes; purchases of companies, clinics, restaurant chains etc.. During the money laundering procedure can be involved: lawyers specialized in company law, accountants, notaries, real estate agents, insurance agents, trust companies, banks, financial institutions. It is estimated that a bank which operates in the field of money laundering, for instance, gains a source of income between 10% to 40% of the amounts paid for this purpose.

Different money laundering techniques are mainly applied through a double typology of transactions: on one side, those having a fictitious economic purpose that aim to dissimulate the illicit origin of the money; on the other, those transactions that aim to hide the real owners of the assets through figureheads. The first kind of transactions, for example, uses fake invoices to justify money transfers through fictitious imports, that can provide a justification regarding funds transfers to suppliers located abroad. The second type of transactions is, instead, carried out through a simulated negotiation with the purpose to hide the real owner of the wealth.

In both cases it is possible to detect similar techniques and patterns used for tax evasion: indeed, both the use of fake invoices and the fictitious use of intermediaries constitute an extremely diffused phenomenon in the field of evasion conducts. Therefore, criminal phenomena (and *firstly* the money laundering) and tax evasion are extremely connected.

Also for this, in the new community directive regarding anti money laundering is now expressively provided the reference to tax crime related to direct and indirect taxes. New anti-money laundering regulations, approved by the European Commission, jointly to the regulation regarding informative data of transfers of funds, in order to guarantee the "traceability," clarify, in fact, that anti-money laundering and evasion are more and more two sides of a coin. In fact, the Commission underlines that the inclusion of tax crimes linked to direct and indirect taxes is the result of the indications of the FATF (Financial Action Task Force).

Definitely, money laundering is useful and profitable for financial and economic crime and it is an important aspect in order to accelerate and expand global crime in the economy and finance. Moreover the complexity of this phenomenon has caused economic and social consequences: it contributed to accelerate the instability of international capital movements and currency prices and could destabilize the bank system. In the end money laundering put entire sectors under the control and the influence of organized crime altering the competition: companies can easily cut prices or even "producing at a loss," by virtue of the fact that their real financing comes from other sources. Actually, money laundering can put entire countries under the control of the organized crime.

5. International instruments against tax havens

The OECD struggle against the illegal use of tax havens officially started in 1998 with the publication of the Report named "*Harmful Tax competition- an Emerging Global Issue*," drafted following the request proposed by the Ministers of the member States to develop specific measures against the distorted effects of harmful tax competition on investments and financing decisions as well as on national tax bases. The first issue examined by the Report concerned the identification of the criteria in order to distinguish legal tax practices from harmful ones. The second one concerned the elaboration of a list of countermeasures summarized in nineteen recommendations that member states were invited to adopt in order to impede the diffusion of the phenomenon in question efficiently.

In particular, those recommendations aimed to increase the efficiency of the internal measures already adopted by the member states, avoiding the application of the international conventions that could favor harmful tax competition phenomena and eventually intensifying the international cooperation. The first recommendation concerns the introduction of an internal disposition regarding the CFC – Controlled Foreign Companies. Precisely, the Organization invited member states without any regulation regarding this issue to adopt the CFC rules or equivalent regulations as a possible solution for the harmful tax competition. Countries which are already provided by this regulation were instead invited to extend the implementation to all tax practices that could be considered harmful by the virtue of the criteria mentioned in the Report. The Report of 1998 ended with the commitment of the member States to avoid any measure that could be harmful as well as to remove, within 5 years from the date of the approval of the guidelines by the Council (within April 2003), all the harmful aspects present in their tax regimes.

On the basis of the previous indications, in June 2000, the OECD published a new Report named “*Towards Global Tax Co-operation*,” in which 47 tax regimes considered potentially harmful have been identified. In this mentioned Report was also published the first blacklist which includes 35 states or territories labeled as tax havens where the deadline for the removal was more urgent compared to the potentially harmful tax regimes. In particular, States were invited to send by 31 July 2001 an *advance commitment letter* that is a letter with which they committed to eliminating the harmful tax practice adopting new measures, and avoiding the introduction of new others, and ensuring an appropriate information exchange with foreign financial administrations. Moreover, the OECD requested a detailed plan where it was indicated the timing and the conditions through which the tax haven would have eliminated the harmful practice.

A determining change of direction occurred with the publication of the report “*The OECD’s Project On Harmful Tax Practice*” where the lack of a proper exchange of information became according to the OECD the main criterion to identify tax havens. According to the organization, in a now global economic context, each single government could not longer rely solely on information from internal sources to guarantee the fulfillment of the tax obligations by their taxpayers. Therefore, the exponential increase of transnational transactions made by these taxpayers requested a close collaboration of the different foreign tax administrations.

In the following Reports, remarkable progresses reached by the organization against the harmful tax practices were put into light. Following the publication of the first black list in 2000, in fact, States included in this list have promptly shown their willingness to remove any harmful tax practices in their tax systems. In particular in 2002 only seven of the thirty five Countries were again considered tax havens, subsequently reduced to five in 2003. As regards to potential harmful tax systems, instead, the Report of 2006 underlined that 18 of the 47 harmful tax systems initially identified were abolished, 14 modified and 13 considered more harmful after more accurate analysis.

After the publication of the Report “*Addressing Base Erosion and Profit Shifting*” in February 2013, OECD initiated a new international project to obstruct tax base erosion phenomenon through the fictitious transfer of incomes in tax havens. Unlike the previous reports, this project do not focus on the identification of the peculiarities of harmful tax practices, but rather, on what let corporations practice tax strategies particularly aggressive. In other terms, the attention of the Organization moved from the requisites that let a Country to attract foreign investments in its territory to the detriment of third countries, to the ways used by States to erode the tax base of their resident country through the fictitious transfer of incomes in tax havens.

The requirement to adopt a new action plan came about from the awareness that international tax regulations contained in each single legal system were not more adequate to regulate an economic system where interactions between different tax systems became more and more frequent. Up to then, therefore, member States planned their own tax system without taking into consideration the effects caused by the tax regulations of other foreign countries, because, in a closed economic context, cross- border transactions were rather marginal because of the insufficient mobility of the capital. Globalization process and the subsequent increasing of international exchanges have meant that existent *mismatches* between the different national legal systems caused numerous cases of double non-taxation, punctually used by multinational companies to reduce their tax burden. Recent studies in this matter

have in fact shown how tax plan schedules adopted by societies became by the time particularly aggressive because they were focused to transfer the produced wealth to locations with a particularly low level of taxation. Therefore, these strategies have caused a mismatch between the State where the incomes were produced and the State where these were effectively taxed. The project aimed to bring back the taxation of the profits in the Countries where the activities took place and where the added value was actually produced, so as to render ineffective those planning strategies that exploiting the obsolete rules and the scarce coordination between the different national tax systems, reducing the tax revenue of the single States. For this purpose, in July 2013, the organization published an international Action Plan composed generally by 15 actions that member states should have implemented within two years from the date of publication.

The 29th October 2014, in Berlin, G20 Countries and small off-shore tax havens, signed an historic agreement with regard to combating international tax frauds. All this, thanks to the commitment of the OECD. More than 90 Countries signed an agreement to pass to the automatic exchange of tax data about taxpayers around the world, including information such as for example having a bank account abroad, the collection of income or interest, the purchase of company shares. In 58 Countries it started from 2017, while in others 34 from 2018. Only Panama, Bahrein, Cook islands, Nauru and Vanuatu confirmed their refusal to conform themselves to this agreement. It was important, because among the signatories there were states or territories that up to then, were based on the policy of bank secrecy, such as Luxembourg, Austria, or off-shore centers often labelled for their lack of transparency, such as Cayman or Bermuda. It does not concern to a symbolic agreement, because it has obliged tax administrations to transmit data according to the OECD regulations regularly. This exchange mode would have improved the procedure, which was based on request of data only following administration or judicial investigations on subjects suspected of fraud.

In accordance with the developing of the OECD, also European Commission has recently reinforced the struggle against aggressive tax plan. On the 28th January 2016 the Commission, in fact, published a new anti-evasion package of measures with both legislative and non-legislative initiatives in order to impede aggressive tax plan and increase tax transparency to create in the European Community a more fair context for companies. Particularly remarkable is the Council Directive that contains regulations against tax evasion practices that directly have an impact on the internal market² (so called “*Anti Tax Avoidance Directive*” or ATAD), adopted by the Council on the 12th July 2016. The objective of the provision is to facilitate the implementation of the recommendations disposed by the OECD in the European Community. In particular the Directive introduced specific disposals in matter of:

- deductibility of the interest expenses (art.4). This regulation aims to prevent the fictitious transfer of intra group debts in Countries where more favorable deductibility regulations are applied;
- outbound tax (art. 5). The purpose of this provision is to discourage the transfer of the tax residency of tax payers and/or their assets in low taxation countries solely in order to reduce the due tax burden;
- general anti abuse clause (art. 6). This provision is intended to fill any possible gap in the anti-abuse regulations in force;
- foreign subsidiary companies (art. 7 and 8). The regulation aims to prevent the affected transfer of profits to low taxation jurisdictions, exclusively to obtain a remarkable tax saving and divert the taxation of the country of residence;
- Hybrid mismatches (art. 8). This provision is meant to avoid those practices that through the mismatch of national tax systems they obtain situations of double non-taxation.

With regards to the implementation, member States must apply the Directive by 31 December 2018.

As previously mentioned, among the regulations contained in the recent Directive, also those regulations related to CFC are included. In particular, the measures contained in articles 7 and 8 of the mentioned provision can be applied to tax payers which, alone or jointly to subsidiary companies, hold in the foreign company a shareholding able to guarantee them the majority of the voting rights, to the capital namely to the profits. Therefore, the

² Directive n.2016/1164 EU on the 12th July 2016.

forementioned provision, includes, in the subjective context of the implementation of the regulation, both the cases of control of law and those cases related to economic control, in accordance with OECD recommendations.

6. Conclusions and open issues

In the light of this, we can affirm that the most dangerous issue of tax havens is represented by the real risk that large amounts of money made through business activities and transferred to tax havens in order to evade taxes once they reached bank vaults of these countries, these amounts can be confused with other available funds obtained by illicit activities (more criminal compared to tax evasion), creating new money laundering forms and other criminal practices, until the traces and the origin of financial transactions go lost. The development of the tax havens issue has been described from some recent events that involved global economy in the last years. For instance, the case "*Panama Papers*," although it has not been defined, it seems to show how recurring to tax havens has been not only a way to pay less taxes but also an instrument to hide remarkable accounting and financial statement fraud. Recent events that have involved important and consolidated industrial and financial corporations have pointed out how national control tools can be insufficient to prevent and fight against criminal phenomena perpetrated on international financial markets.

The advent of Internet and the e-commerce, in this context, has promoted new opportunities but also generated complexity. It has been noted how these instruments can be, on one side, a real and not "virtual" help to money laundering, and, on the other, an additional and dangerous obstacle for competent national authorities to control and fight against these activities. Moreover, considering the problematic peculiarities connected to the e-commerce, if this activity is managed by a company located in an off-shore center we could talk about "haven within haven," where the guarantees for the launderers are integrated and strengthened, creating an invincible juridical stronghold.

During the year, governments, being aware of this situation, have started to promote coordinated international activities to fight against money laundering through combined and common measures. Conventions have been stipulated with States included in the so-called *black list* in order to trade according to correct parameters and to demonstrate a greater sense of responsibility from financial institutions. However, up to now, some bank and financial off-shore systems continue to practice secrecy and confidentiality policies.

Several initiatives have been carried on at the international level, in order to obtain some successes regarding information exchanges, impeding that loyalty policy practiced by banks during the transfer of assets toward tax havens. The European Union established the principle of automatic exchange of information through Saving Tax Directive, and it has indicated a global model for the cooperation in tax matter. Also the OECD, independently, focused on procedure and systems of information exchange between national tax authorities. The outcome is unequivocal, there is the necessity of an international tax organization that mainly can ensure minimum standards of transparency and cooperation among states, in order to limit negative global implications came about from internal tax system, such as those of tax havens. In this regards many proposals have been carried out by experts and international organizations. Among these we can essentially mention three:

- i. the creation of "*a global register of financial assets that registers the owners of all outstanding shares and bonds.*" This would be a register, accessible to all tax authorities of the countries, indicating who owns the financial securities, shares, bonds and shares of mutual investment funds in the world. The International Monetary Fund could be the Authority able to have the technical skills to make it work in the medium term;
- ii. the provision of "*sanctions proportionate to the cost that tax havens impose on other countries,*" possibly imposing customs duties on those countries with privileged taxation that do not assume cooperative behaviors;
- iii. "*the review of corporate taxation*" based on consolidated profits around the world and not on profits Country by country.

Ultimately the fight against the phenomena just mentioned and, therefore, against crime encounters many obstacles. It is relatively easy to demonstrate how numerous proposals and concrete solutions exist but that the open questions remain mostly devolved to the governments and the national and international *decision-makers*.

As extensively demonstrated, financial globalization has favored the interweaving of licit and illicit economies, especially in those places outside the law that are financial havens. The rights of nations and people have not longer say in the matter, in these territories, because the most powerful states were those who have tolerated or favored their development. The most effective solutions can, therefore, be found only by carefully considering the fact that the issue of crime and tax havens is a purely "political" issue.

References

- Ardizzi G., Petraglia C., Piacenza M., Turati G. (2012), Measuring the underground economy with the currency demand approach: a reinterpretation of the methodology, with an application to Italy (Working papers), Banca d'Italia, N. 864 - April;
- Becchi A. – Rey G.M. (1994), *The criminal economy*, Laterza, Rome – Bari;
- Caramognoli G. (2011), *Main Outlines of law enforcement action*, in Black list and tax havens, Rimini, MAGGIOLI Editore, p. 13.
- Carbone M., Bosco M., Petese L. (2015), *Tax havens geography*, IPSOA Manuali, Wolters Kluwer, Milan;
- Catalano I. (2011), Dossier on *Organized Crime and tax evasion, the fight against tax evasion as an instrument against organized crime and to the diffusion of activities formally legal*. *Instruments Res*, Year III, N. 4, October;
- Daniele V. (2017), *Tax havens and globalization. Notes on the hidden wealth of Nations. Tax havens inspection*, by G. Zucman, Ed. ORDINES, ISSN 2421-0730N. 1 – June;
- European Union Directive n. 2016/1164 UE of the 12th July 2016 containing regulations against tax elusion practices that directly have an impact on internal market;
- Gara M., De Franceschis P. (2015), *Tax havens: operative peculiarities, empirical evidence and financial anomalies*, Banca d'Italia, Financial Information Unit for Italy, Anti Money Laundering Notebooks, n. 3;
- Gourguechon G. et al. (2001), *Tax havens, Outlaw finance*, curated by ATTAC France, ASTERIO Ed., April;
- GUARDIA DI FINANZA (ITALIAN FINANCE POLICE) – Scuola di Polizia Tributaria (Italian Tax Police Academy) (2008), *Economic, financial and criminal profiles in the international context: analysis of some countries in the area of Central and South America*, curated by Officials of the 35° Advanced Course of Italian tax Police Academy, 2007 – 2008;
- ISTAT (2017), *Report on the unobserved economy and on tax and social security evasion, Year 2017* (art. 10-bis.1 c. 3 Law 31st December 2009, n.196), ISTAT (Italian National Statistics Institute);
- Leo M. (2006), *Income tax in the Consolidate Law*, Giuffré, Milan, p. 2100;
- OECD (Organization for Economic Cooperation and Development) (1998), Report “*Harmful Tax competition- An Emerging Global Issue*”. Available at: <https://www.oecd.org/tax/transparency/44430243.pdf>;
- OECD (2001), Report “*The OECD’s project on harmful tax practices: the 2001 Progress Report*”. Available at: <https://www.oecd.org/ctp/harmful/2664450.pdf>;
- OECD (2006), Report “*The OECD’s project on harmful tax practices: 2006 update on progress in member countries*”. Available at: <https://www.oecd.org/ctp/harmful/37446434.pdf>;
- OCSE (2015), Report “*Designing Effective Controlled Foreign Company Rules*” in ACTION 3: 2015 Final Report. Available at: <http://www.oecd.org/ctp/designing-effective-controlled-foreign-company-rules-action-3-2015-final-report-9789264241152-en.htm>;
- Parisi A. (2004), *Markets, companies and banks – Structure and functioning*, Giuffré Editore, Milan;
- Razzante R., Palumbo G. (2014), *Organized Crime, money laundering and tax evasion: from Al Capone to Sciascia, up to “redditometro” (method of assessing income)* Cap. I, Vol. *The new frontiers of financial crime. Tax evasion, frauds and money laundering*, Filodiritto Editore, Bologna, March;
- European Parliament Resolution of 11 June 2013 regarding organized crime, corruption and money laundering: recommendations regarding actions and initiatives to be taken (interim report) (2012/2117(INI)) (2016/C 065/03), GUCE C 65/16;
- Shaxson N. (2014), *Treasure islands: A journey to tax havens where globalization treasure is hidden*, Feltrinelli;
- Zucman G. (2017), *The hidden wealth of the Nations. Tax havens investigation*, add editore, Torino, 2015 (con prefazione di T. Piketty). N.1.



Building Acceleration of Economic Growth Model Through Education and Health Budget Allocation: Cases in Indonesia

Hasyim¹, Rina Anindita², Baharudin³, Gunawan⁴

^{1,2}Esa Unggul University , Jakarta, Indonesia. Email: Rina.anindita@esaunggul.ac.id

^{3,4}STIE AMKOP, Makassar, Indonesia

Abstract

The Role of Capital Expenditure on Education, Health Expenditure, on the effort to reduce poverty level is an interesting study because the allocation of expenditure to several countries including Indonesia is quite large, so it is necessary to review the effectiveness of the budget allocation to reduce poverty and increase human economic growth (Psacharopoulos, 1972) in Todaro, 2000). The level of public welfare can no longer be measured from monetary values such as income per capita, but should include non-economic measures (Connolly and Munro (1999); Perkins (2001); Todaro and Smith (2002); and Van Den Berg 2005), and more focus on human development which can be measured from the high government commitment in allocating budget for education, health and other factors which are strongly related to the development of human resources. The objectives of this research are to analyze and assess on how: (i) the impact of the allocation of education capital expenditure and the allocation of health expenditure on the Human Development Index; (2) the influence of human development index on economic growth; (3) the effect of economic growth on the level of poverty; and (4) the interpretation of the economic growth acceleration model. The research was conducted by taking samples in 23 regencies/municipalities in South Sulawesi Province which is one of the provinces with the highest economic growth rate in Indonesia. The data used is Panel data with period 2004 - 2016, then processed by using regression analysis method. The Result of the Research from the first model., it shows that from the t test, it is found that the variables contained in the data which give significant effect to the Human Development Index is the allocation of Education fund, at the real level of 5%. The value of R2 generated in this model is 0.637 which means that 63.7% of the human development index in 23 urban districts for 10 years is explained by the variables in the model, the allocation of education and health funds, the rest by other variables in the model. The variables in the allocation of education funds have a negative influence on the human development index. The value of regression coefficient of this variable is 0.72 with p-value of 0.003. meaning that any 1% increase in health allocation funds will reduce the human development index by 0.72. For the panel data analysis with this random effect model there are individual and time effects that show differences in human development indexes between districts and municipalities and between years. So the value of constants to be obtained will be different for each district/municipality and different for each time. The determinant coefficient value generated in model 1 shows the figure of 0.637 means that 63.7% of the human development index is explained by the variables in the model, i.e. the allocation of education and health funds. In model 2 it was found that the value of determinant coefficient is 0.0854, which means that only 8.5% of the diversity of economic growth in the twenty three districts/municipalities in South Sulawesi in the period 2007-2016 explained by the variables on the human development index.

Keywords: Education Budget Allocation, Human Development Index, Economic Growth, Developing Countries

INTRODUCTION

The problem of poverty in Indonesia has always been the main concern, as the government has realized that failure to overcome the problem of poverty will lead to the emergence of various social, economic, and political issues within the community. Over the last few decades Indonesia's economic growth has experienced ups and downs in accordance with world economic conditions, where the national income which is the benchmark of economic growth shows fluctuating growth

According to Mankiew (2008), human resource development can be done through improving the quality of human capital. Human capital that refers to education and health is a fundamental development objective in a region, namely education is essential to achieve a decent life, while health is the core of prosperity. Improving the quality of human capital depends on the availability of infrastructure to support investments in human resources, such as housing and transportation, which are public goods provided by the government in order to meet the needs of the community.

The allocation of local government expenditures reflected in the Regional Budget (APBD) will have a positive impact on human development as well as economic growth, primarily the allocation of direct spending on education, health and infrastructure. These three direct expenditure allocations will be outlined in personnel expenditure, goods and services expenditures, and capital expenditures, indicating that personnel expenditures and goods and services expenditure are incapable of contributing to human development and economic growth, and only capital expenditures is capable of responding to human development and economic growth.

Connolly and Munro (1999); Perkins (2001); Todaro and Smith (2002); and Van Den Berg (2005), similarly offer a measurement of the achievement of economic development objectives on more abstract matters relating to the social, cultural and economic aspects of society which focus more on the level of human development progress.

In the essence that development is human development, so it needs to be prioritized that the allocation of spending for this purpose lies in the preparation of budget (Adi, 2009). Human development can be observed through the size of the Human Development Index (HDI), where HDI is one way to measure the level of physical and non-physical qualities of the population. Physical quality is reflected in life expectancy, while non-physical (intellectual) quality through the average of school attendance and literacy rate, as well as the economic capacity of the community as reflected in the purchasing power value of parity index.

Based on these perspectives, there is a need for in-depth and systematic study on the performance of regional development policies through the implementation of local expenditure allocations to reduce poverty levels through HDI and economic growth. Conceptually the development approach puts development policy in a strategic and important position in development acceleration. This can be spelled out in more effective and efficient regional fiscal policies that can directly address the basic needs and requirements of the community through the allocation of local spending for public services and the construction of basic community infrastructure.

Empirically, there have not been many studies that specifically verified and estimated capital spending capabilities of education, health, and infrastructure in APBD in reducing poverty through economic growth in response to human development, and Social Overhead Capital (SOC) especially the regencies/municipalities in South Sulawesi. Thus, local development policy makers do not have sufficient scientific references in allocating their APBD expenditures appropriately to reduce poverty, aimed at increasing the acceleration of economic growth.

The objectives of this research are (i) to analyze and examine the effect of allocation of education capital expenditure and health expenditure allocation to Human Development Index in South Sulawesi Province; (2) analyze and test the effect of HDI on economic growth in South Sulawesi Province; (3) analyze and examine the effect of economic growth on poverty level in South Sulawesi Province; and (4) interpretation of the economic growth acceleration model.

LITERATURE REVIEW

Education and Health Expenditure with Development Index

The allocation of spending on education and health is an instrument for improving the quality of human resources, which in turn impacts on poverty alleviation. As Sepulveda, 2010 states that pro-poor government spending is the allocation of basic health spending and basic education. This is because good education and health enable the poor to increase the value of their assets because their most important asset is their labor (Lanjouw, Pradhan, Saadah, Sayed, and Sparrow, 2001).

According to Todaro (2006), education and health are the fundamental development goals, to form broader human capacities that are at the heart of the meaning of development. On the other hand, poor communities who generally have no resources except energy capital, health becomes the most essential need. Health and education can be seen as a vital component of growth and development and an input of an aggregate production function. Its double role as input and output causes health and education very important in economic development.

Improvements in education and health will affect human development outcomes. Considering that indicators in the human development index (HDI) by UNDP put education and health as the main indicators in addition to economic indicators. Psacharopoulos (1972) in Todaro (2000) proves that education does have a positive influence on the development of economic growth. Improving health, education and nutrition is not only able to increase the capability, but also an important means in improving "human capital" in the future.

Human Development (IPM) Against Economic Growth

Human capital is one important factor in the process of economic growth. It can be believed that the economic performance will be better if human capital is qualified, in this case shown in the level of education, health, or other indicators as can be seen in various human development reports published by the United Nations Agency for Human Development (UNDP).

Thus, economic development should be considered in order to spur economic growth, including in the context of regional economies. This is important because development policies that do not encourage human quality improvement will only make the area concerned lag behind other regions, including in terms of its economic performance. Furthermore, improving the quality of human capital is also expected to provide benefits in reducing imbalances between regions, especially countries that have a wide area and a high level of socio-economic diversity.

High human development will be achieved as a result of stable economic growth conditions, through which economic growth will create health and education services, and open employment opportunities for the population. Conversely, high achievement of human development will encourage stable economic growth, which human development will create a qualified workforce, the birth of technological innovations, and trusted management.

Economic Growth and Poverty Rate

The Neo Classics pioneered by Solow who initiated the early model of economic growth (Solow Growth Model) argue that how savings, population growth and technological advances affect the level of economic output and growth over time. The Solow model is based on a production function that relies on capital and labor stocks, then assumed to have a constant scale return, so as not to affect the relationship between output workers and working capital, if the size of the economy is measured by the number of workers. Furthermore, (Lin, 2003; Bourguignon, 2004; Ravallion, 2005; and Warr, 2000, 2006) argue that high economic growth will enlarge economic capacity (Gross Domestic Product). High GDP is expected to create trickle down effect so that the welfare of society will increase, and will ultimately reduce the level of poverty, or better known as pro-poverty economic growth.

The concept of pro-poverty growth was first introduced in the 1950s and later confirmed by Chenery in 1974. (Kakwani and Pernia, 2000). Furthermore, it is implicitly described in the World Development Report 1990 (World Bank, 1990). Furthermore Bigsten and Levin (2000) argue that successful countries in growth are likely to succeed in reducing poverty, especially if there is appropriate policy support and institutional environment. Dollar and Kraay (2002) say that growth will provide far greater benefits for the poor if growth is accompanied by policies such as law enforcement, fiscal discipline, openness in international trade, and poverty alleviation strategies.

RESEARCH METHODS

Data

The data in this study are collected from 23 regencies/municipalities in South Sulawesi Province covering 20 districts and 3 cities, during the period of 2004-2014. This study uses pooled data by combining 23 districts/municipalities cross-section data and 11-year time-series data. Because the relationship between variables in this study is time-lag, the observation period for exogenous variables (predictors), which in this case the allocation of capital expenditure (education, health, and infrastructure) in APBD earlier in the year (t-1), both on the initial and final period of observation, while human development, social overhead capital, and economic growth, which is the endogenous variable (intervening), and the poverty level which is the endogenous variable (dependent) is the actual year period (t). Year 2004 was chosen as the initial observation for exogenous variables, and 2014 as the final year of observation for endogenous variables.

Data Analysis Method

Methods of data analysis using panel data regression, with several models built. In the first model the factors that determine the Human Development Index, with the variables of educational expenditure and health expenditure. The first model built is as follows

$$Y_{it} = \alpha + \beta_1 x_{1it} + \beta_2 x_{2it} + \mu_i + \gamma_t + v_{it}$$

With

- i : 1, 2, ..., 23, shows number of districts/municipalities in South Sulawesi
- t : 1, 2, ..., 10. time period under study *2007- 2016
- α : Interception coefficient
- β_1, β_2 : Slope Coefficient
- μ : The specific influence of the individual no.-
- γ : Effect of time t
- v_{it} : Effect of error on the i-th district/municipality and time t
- Y_{it} : Dependent variables (Human Development Index) for i-district and time-t
- x_{1it}, x_{2it} : The independent variable (Education and Health fund) for the i-th district and the time t

Second model is the factor that determines the rate of economic growth, with the variable is determined as Human Development Index.

The second model is

$$Y_{1it} = \alpha + \beta_3 Y_{it} + \mu_i + \gamma_t + v_{it}$$

- Y_{1it} : Dependent variable (Economic Growth) for district i and time t
- Y_{it} : The independent variable (Development Index) for the i-th district and the t-th time

The third model is the factor that determines the level of poverty, with the variables are the level of economic growth and Human Development Index.

The Third Model is

$$Z_{it} = \alpha + \beta_4 Y_{1it} + \beta_5 Y_{it} + \mu_i + \gamma_t + v_{it}$$

Z_{it} : Dependent variable (Poverty Rate) for district i and time t
 Y_{it}, Y_{1it} : Independent variable (Human Development Index and Economic Growth) for the district i and time t

After the model is made, then we proceed with the appropriate model specification for the three models, with the following stages:

1. Chow test, to test whether there is influence between individual and time. Chow test is done twice, the first to test whether there is an individual influence on the model used, with the following hypothesis:

$$H_0: \mu_1 = \mu_2 = \dots = \mu_{N-1} = 0$$

$$H_1: \text{at least there is one } i \text{ so } \mu_k \neq 0$$

The second is to test whether or not there is a time influence on the model used, the hypothesis test is as follows:

$$H_0: \gamma_1 = \gamma_2 = \dots = \gamma_{N-1} = 0$$

$$H_1: \text{there is at least one } t \text{ so } \gamma_k \neq 0$$

If from the second hypothesis testing it is obtained that H_0 is not rejected, then the appropriate model has no influence of time and individual from the model, as follows:

$$Y_{it} = \alpha + \beta_1 x_{1it} + \beta_2 x_{2it} + v_{it}$$

If in the first hypothesis H_0 is rejected, and in the second hypothesis H_0 is not rejected, then there is an individual influence on the model:

$$Y_{it} = \alpha + \beta_1 x_{1it} + \beta_2 x_{2it} + \mu_i + v_{it}$$

If the first hypothesis H_0 is not rejected and the second hypothesis H_0 is rejected, then there is a time influence on the model:

$$Y_{it} = \alpha + \beta_1 x_{1it} + \beta_2 x_{2it} + \gamma_t + v_{it}$$

If in the first hypothesis H_0 is rejected and in the second hypothesis H_0 is rejected, then there is the influence of both individual and time on the model, so that the model is formed as follows::

$$Y_{it} = \alpha + \beta_1 x_{1it} + \beta_2 x_{2it} + \mu_i + \gamma_t + v_{it}$$

2. Testing violations of assumptions, lack of correlation using Durbin Watson test, normality by looking at the standard leftover graph, and non-multicollinearity by looking at the value of Variance Inflation Factor
3. Model evaluation and Interpretation of coefficients

RESULT AND DISCUSSION

Result of Model Testing 1

The first model, with dependent variable is the human development index, the independent variables of education and health funds. The first model specification, for the first stage of the CHOW test, is performed to select the appropriate model, between the combined model, the individual fixed influence model or the fixed influence model of time. Chow test uses statistics F. In the first Chow test is a hypothesis to test whether there is influence of individuals on the model used. The result obtained is the -p value of the statistic F less than 0.05, so H_0 is rejected, which means that in this model there is an individual influence. Continued on the second hypothesis for the Chow test, the p-value obtained from the static F test is also less than 0.05 so that the second hypothesis is rejected, meaning in the model there is the effect of time. These results can not be determined whether the right model is the model of individual fixed influence (Fixed Effect) or the model which is influenced by time (random effect). The model specification is proposed by using Hausman Test to determine whether the appropriate model is a model with Fixed Effect or model with Random Effect.

Hausman Test, using the following hypothesis:

H_0 : there is at least one t so $\gamma_k \neq 0$ (Random Effect)

H_1 : at least there is one i so $\mu_k \neq 0$ (Fixed Effect)

The Hausman test uses the statistical value of F Test. The result of the test for this model, the obtained value of p from the statistic F is 0.8306 or greater than 0.05 so that H_0 is not rejected, it means that the correct model for the first model is Random Effect. It estimates that the data on panels may be interconnected between time and between individuals. In the random effect model, interdependent differences are accommodated by the error terms of each district/municipality. By seeing that in the first proper model is the random effect, the built equations do not need to test the heteroscedasticity, since the advantage of the random effect model has eliminated the problem of heteroscedasticity and auto correlation.

After going through various stages of testing, it has been obtained that the appropriate model is the model of random influence, as follows:

$$Y_{it}(\text{Human Development Index}) = \alpha + \beta_1 x_{1it} + \beta_2 x_{2it} + \mu_i + \gamma_t + v_{it}$$

$$Y_{it}(\text{Human Development Index}) = (\mu_i + \gamma_t) - 90.228 - 0.196 \ln X_1 - 0.72 \ln X_2 + v_{it}$$

The model illustrates the effect of variables in 23 districts/municipalities in South Sulawesi from 2007 to 2016. Based on the F test it has been achieved that p -value for F statistics is 0.000. This shows at the real level of 5% that there is at least one independent variables in the model that significantly influence the Human Development Index.

As for the t test, it is found that the variables contained in the data which give significant influence to the Human Development Index is the allocation of Education fund, at the real level of 5%. The value of R^2 generated in this model is 0.637 means that 63.7% of the human development index in 23 districts/municipalities for 10 years which is explained by the variables in the model, i.e. the allocation of education and health funds, as much as any other variables in the model. The variables in the allocation of education funds have a negative influence on the human development index. The value of regression coefficient of this variable is 0.72 with p -value of 0.003 meaning that any 1% increase in health allocation funds will reduce the human development index by 0.72. For the panel data analysis with this random effect model there are individual and time effects that show differences in human development indexes between districts and municipalities and between years. So the value of constant to be obtained will be different for each district/municipality and the value is different for each time.

Model 2 Test Results

Second model, with economic growth rate as dependent variable, independent variable of human development index. The first model specification, for the first stage of the Chow test is performed to select the appropriate model, between the combined model, the individual fixed influence model or the fixed influence model of time. Chow test uses statistics F. In the first Chow test there is a hypothesis to test whether there is influence of individuals on the model used. The result obtained is the p value of the statistic F is less than 0.05, so H_0 is rejected, which means that in this model there is an individual influence. Continued on the second hypothesis for the Chow test, the value obtained p is 0.007 from the static test of F which is also less than 0.05 so that the second hypothesis is rejected, meaning that the model is the effect of time. These results can not be determined whether the right model is the model of individual fixed influence (Fixed Effect) or the model is influenced by time (random effect). For that we do not need a model specification by using Hausman Test.

The second model is Fixed Effect. This model assumes that individual differences, in this study means each district/municipality, can be accommodated from different interceptions. Nevertheless the slope is the same for the inter district/municipality. But with the Fixed Effect model must pass Autocorrelation test. Autocorrelation test uses Wooldridge test for panel data, the result is the value of p for F test of 0.43 or above 0.05 means that this data is independent from autocorrelation problem.

After going through various stages of testing, it was found that the appropriate model is the model of random influence, as follows:

$$Y_{1it} = \alpha + \beta_3 Y_{it} + \mu_i + v_{it}$$

$$Y_{1it}(\text{Economic Growth}) = \mu_i - 20.878 - 0.199Y_{it} + v_{it}$$

The model illustrates the effect of independent variables for 23 districts/municipalities in South Sulawesi on Economic Growth in the period of 2007-2016. From t test it is found that the human development index variables give p-value of 0.000 at 5% real level. Thus, the human development index is a variable affecting the rate of economic growth. The value of R2 is 0.0854, which means that only 8.5% of the diversity of economic growth in the twenty-three districts/municipalities in South Sulawesi in the period 2007-2016 can be explained by the independent variable of the human development index, while the rest is explained by other variables outside the model. The human development index has a negative influence on economic growth. The coefficient value of this variable is -0.199 with a p-value of 0.000, meaning that any increase in 1 index of human development will decrease economic growth by 0.199%.

For the analysis of panel data with this fixed effect there are individual effects showing different economic growth between districts/municipalities based on the model specifications used, the constant values held by each district/municipality remain at all times observed and the value is different for each district/municipality.

Discussion

In general, the economic growth of the regencies/municipalities of South Sulawesi Province in the last five years (2009-2013), shows that the economic growth is quite high, even exceeding the national economic growth, which grows on average 7.32 percent per year and grows by 1.5 percent during the period of 2009-2013, where in 2009 the economic growth of South Sulawesi experienced 6.43 percent increase to 7.93 percent in 2013. The problem is the allocation of education funds and the allocation of health funds based on the results of statistical calculations using panel data, shows that the variable is negatively correlated. With the index of human resource development, in other words, the change of education fund allocation and health funding is inversely proportional to the development of human resources

The cause of this is probably due to unfulfilled macro assumptions in the implementation of allocated funds. According to Mankiw (2008) human resource development can be done through the improvement of the quality human capital that refers to education and health as a fundamental development objective in a region, namely education is essential to achieve a decent life, while health is the core of prosperity. Barro and Sala-i-Martin (2004) introduced an endogenous model that emphasized the importance of fiscal policy to foster economic growth that ultimately leads to poverty. The neoclassical model, in general, emphasizes the supply of labor, capital stock and technological change in the process of economic growth, which later developed into a human capital model in economic growth

Research Findings

The results showed that in model 1, there was a negative correlation between the variables of the allocation of education funds and the allocation of health funds to the human development index variables. This means that the increase in the allocation of education and health funds actually saw a decrease in the human resource development index, this finding is contrary to the theory used which states that supplementary allocations of education and health funds should encourage an increase in human development index.

Similarly in model 2 there is a negative effect between human development index variables on the rate of economic growth in South Sulawesi Province. This means that in the event of a decline in the human development index on the other hand there is economic growth. This condition indicates a paradox on factors that should run linearly between indices of human development and economic growth. A further hypothesis of this paradox is that there are assumptions that are not included in the calculations such as the assumption that an increase in the human

development index leads to an increase in the level of consumption ultimately prompting the Demand Pull Inflation.

CLOSING

Conclusion

In model 1 the allocation of education funds and the allocation of health funds are negatively correlated with human development index. In Model 2 human development index is also negatively correlated with economic growth. Thus it is concluded that the findings of this study need to be followed up by incorporating new assumptions such as budget allocation control factors to maintain effectiveness at budget allocations.

The results show that the right model to see the effect of education and health fund allocation on human development index is random effect model and to see the effect on economic growth and poverty rate we can use fixed effect. Further results indicate that the allocation of education funds has an impact on the human development index. The human development index affects economic growth and high economic growth will reduce poverty levels.

Suggestion

The allocation of education funds and health funds as an effort to improve and develop human resources should be done through the improvement of the supervision of allocation of funds in order to target the right, then the importance of fiscal policy to encourage economic growth which ultimately leads to the level of poverty. Assumptions that need to be considered are the provision of labor, capital stock and technological changes in the process of economic growth, which later developed into a human capital model in economic growth. In further research it is necessary to consider other variables that lie outside the scope of this study, such as the effect of huge infrastructure spending.

References

- Adams, Richard H. Jr, 2003. Economic Growth, Inequality, and Poverty: Finding from a New Data Set, Policy Research Working Paper #2972, World Bank, February.
- Ahluwalia, Montek S, dan Hollis B. Chenery, 1979. Growth and Poverty in Development Countries, *Journal of Development Economics*, Volume 16 September 1979, pp. 298-323.
- Anand, S. and Sen, A. 2000. Human Development and Economic Sustainability, *World Development* 28 (12): 2029-2049
- Balisacan, A. and Pernia, E. 2002. Probing Beneath Cross-national Averages: Poverty, Inequality, and Growth in the Philippines
- Balisacan, A., E.M. Perina, dan A. Asra, 2003. Revisiting Growth and Poverty in Indonesia: What do Subnational Data Show? *Bulletin of Indonesia Economic Studies*, Volume 39, Issue 3, December 2003.
- Barro, R.J., 1990. Government Spending in A Simple Models of Endogenous Growth. *Journal of Political Economy*.
- Barro and Sala-i-Martin 1990, "Public Finance in Models of Economic Growth" WP No 3362, NBER
- Barro, R.J., and Sala-i-Martin, 2004. *Economic Growth* 2nd Edition. London. England. The MIT Press Cambridge, Massachusetts.
- Bigsten, A., & Levin, J. 2001. Growth, income distribution, and poverty: A review. World Institute for Development Research Discussion Paper No. 2001/129
- Boex, Jameson, dkk, 2006, Fighting Poverty Through Fiscal Decentralization
- Cheyne Christine, O'Brien Mike and Belgrave Michael, 1998. Book Review: *Social Policy in Aotearoa/New Zealand: A Critical Introduction*. Article January 1998.
- Christy, Fhino Andrea & Adi, Priyo Hari. 2009. Hubungan Antara Dana Alokasi Umum, Belanja Modal, dan Kualitas Pembangunan Manusia. The 3rd National Conference UKWMS page 14. 10 Oktober 2009: Surabaya
- Connolly, Sara and Alistair Munro. 1999. *Economics of The Public Sector*. New York: Prentice Hall

- Danielson, Anders, 2002. Poverty, Inequality, and Growth in Jamaica, 1988-1998, and Beyond, Paper was presented at the IIIrd CEISEL conference, Amsterdam, July 3-7, 2002.
- Demombynes, Gabriel and Johannes G. Hoogeveen, 2004. Growth, Inequality and Simulated Poverty Paths for Tanzania, 1992-2002, The World Bank, Policy Research Working Paper #3432, October.
- Devarajan, S., Saroop, V., and Heng-fu Zou, 1996. The Composition of Public Expenditure and Economic Growth. *Journal of Monetary Economics* 37:313-344.
- Dollar, David and Aart Kraay, 2002. Growth is Good for the Poor, *Journal of Economic Growth* 7(3): 195-225.
- Gupta, and Mitra, 2004, Economic Growth, Health and Poverty: An Exploratory Study For India, *Development Policy Review*, 2004.
- Hayek F 1945, "The Road to Serfdom" The Institute of Economic Affairs
- Jafarov, Etibar dan Gunnarsson, Victoria. 2008. Government Spending on Health Care and Education in Croatia: Efficiency and Reform Option. IMF Working Paper
- Jhingan, M.L, 1999. *Ekonomi Perencanaan dan Pembangunan*. Jakarta : Raja Grafindo Persada.
- Kaldor, N. 1970, The Case for Regional Policies, *Scottish Journal of Political Economy*, Vol. 18 pp. 337-348. Reprinted in *Scottish journal of Political Economy*
- Klasen, Stephen. 2005. Measuring Poverty And Deprivation In South Africa. *Review of Income and Wealth* Volume 46, Issue 1, pages 33-58, March 2000
- Knowles, Stephen and Owen, P. Dorian. Education and Health in an Effect-Labour Empirical Growth Model. *The Economic Record* Vol. 73. No. 223. 1997.
- Kodoatie, R.J. 2003. *Manajemen dan Rekayasa Infrastruktur*. Pustaka Pelajar, Yogyakarta.
- Koopmans TC 1963, "On the Concept of Optimal Economic Growth" Discussion Paper no 163, Cowles Foundation, Yale University
- Koutsoyiannis A 1982. "Modern Microeconomics, second edition" The Macmillan Press, London
- Kuznets, Simon, 1955, *Modern Economic Growth : Structure and Spread*. London : Yale University Press
- Lanjouw, P, M Pradhan, F Saadah, H Sayed. R Sparrow, 2001 *Poverty, Education and Health in Indonesia: Who Benefits from Public Spending?* World Bank Working Paper No 2739 Washington D C.: World Bank
- Lee, Jong-Wha. 2005. "Economic Growth and Human Development in The" www.hdr.undp.org/docs/publications/occasionalpapers/oc24aa. Pebruari, 6, 2006.
- Lewis, Arthur W., 1954, *Economic Development with Unlimited Supplies Labour*, Manchester : Manchester School Press.
- Li, Hongyi and Liang, Huang, 2010, Health, Education, and Economic Growth in East Asia, *Journal of Chinese and Foreign Trade Studies*, vol. 3 No. 2, 2010.
- Lokshin, Michael & Yemtsov, Ruslan, 2003. "Evaluating the impact of infrastructure rehabilitation projects on household welfare in rural Georgia," Policy Research Working Paper Series 3155, The World Bank
- Majdi, Mekdem, 2012, Study of the Relation Between Health and Economic Growth, *Interdisciplinary Journal of Contemporary Research in Business*, May 2012 vol. 4 No. 1.
- Mankiw, Romer dan Weil 1992, "A Contribution to the Empirics of Economic Growth" *The Quarterly Journal of Economics*, Vol. 107, No. 2, pp. 407-437, JSTOR.
- Mankiw, N.Gregory. 2000. *Teori Makro Ekonomi Ed.4*, Jakarta: Penerbit Airlangga.
- Mankiw, N.Gregory. 2003. *Macroeconomics. Fifth Editions*. New York. Worth Publishers. 41 Madison Avenue.
- Mardiasmo, 2004. *Otonomi dan Manajemen Keuangan Daerah*, Penerbit, Andi Offset, Yogyakarta.
- Martinez-Vazquez, J., and R. McNab, 1997. Fiscal Decentralization, Economic Growth, and Demographic Governance. International Studies Program, Working Paper 97-7, Atlanta, Georgia State University.
- McGee Rosemary and Brock Karen 2001, "From poverty Assessment To Policy Change: Processes, Actors And Data" Working Paper 133, Institutes Of Development Studies, Brighton Sussex England..
- Meier, G. M. dan J. E. Rauch. 2000. *Leading Issues in Economic Development (seventh edition)*. New York-Oxford: Oxford University Press
- Miles, D., G. Myles, dan I. Preston, 2003. *The Economics of Public Spending*. New York, Oxford University Press.
- Mills dan Pernia. 1993. Korelasi Pertumbuhan Ekonomi dan Tingkat Kemiskinan di Indonesia. <https://yusniarisanti0795.wordpress.com>
- Mundle, S 1998, "Financing Human Development: Some Lessons from Advanced Asian Countries", *World Development* 26 (4):659-672
- Musgrave, Richard S., and Peggy B. Musgrave. 1989. *Public Finance in Theory and Practice*. New York: McGraw-Hill Book Company
- Myrdal, G. 1957. *Economic Theory and Underdeveloped Region*, Chapter 3: The Drift Towards Economic Inequalities In A Country
- Oluwatobi, Stephen, O. And Ogunrinola, I. Oluranti, 2011, Government Expenditure on Human Capital Development: Implications for Economic Growth in Nigeria; *Journal of Sustainable Development*, Departement of Economics and Development Studies, Covenant University Nigeria, 2011.

- Onuorah, A.C., and Akujuobi, L.E., 2012. Empirical Analysis of Public Expenditure and Economic Growth in Nigeria. *Arabian Journal of Business and Management Review*. Vol. 1. No. 11. 2012.
- Owen, Robert G. 1987. *Organization Behaviour in Education*. New Jersey: Englewood Clift)
- Parikesit, D., H. Purwoto and O. Z. Tamin. 2000. Economic Impact and Indirect Benefit of the Road Sector Budget. WP04: Technical Report. A Report prepared for SEPM Project Team, Jakarta
- Perkons, D.H., S. Radelet, D.R. Snodgrass, M. Gillis, 2001. *Economics of Development*, Fifth Edition, New York, WW. Norton & Company.
- Pigou, A.C M.A., 1960. *The Economic of Welfare*. Fourth Edition,. London; Mac Millan & CO LTD.
- Poli,WIM, 2010. *Tonggak-tonggak Sejarah Pemikiran Ekonomi*, Brilliant Internasional Cetakan Pertama.
- Pradhan, Rudra Prakash, 2010, Transport Infrastructure, Energy Consumption and Economic Growth Triangle in India: Contigration and Causality Analysis, *Journal of Sustainable Development*, Vinod Gupta School of Management, India Institute of Technology Kharagpur, India, 2010.
- Premchand, Arigapudi. 1999. Public Financial accountability, governance, corruption, and public financial management, by salvatore schiavencampo, ADB. November, Manila: 145-192
- Presber, Julian, J.H., 2011. The Chines Financial System and Its Impact On Economic Growth In China. *The ISM Journal of International Business*, 2011.
- Qiao, Martinez-Vazquez, dan Xu 2008. Expenditure Assignments in China
- Qureshi, Muhammad Azeem, 2009. Human development, public expenditure and economic growth: a system dynamics approach. System Dynamics Group, School of Social Sciences, University of Bergen, Bergen, Norway and Institute of Management Sciences, Bahauddin Zakariya University, Multan, Pakistan
- Ramirez, A., Raniz, G., and Stewart, F. 1998. Economic Growth and Human Capital, *World Development* 28 (2): 197-219.
- Raniz, G., and Stewart, F. Strategy for Success in Human Development.
<http://hdr.undp.or./docs/training/oxford/reading/Ranis%20and%20stewart.pdf> 15 Pebruari 2005.
- Ranis G and Stewart 2002, "Economic growth and human development in Latin America" *Cepal Review* 78
- Ravallion, Martin, 1995. Growth and Poverty: Evidence for Developing Countries in the 1980s, *Economics Letters* 48: 411-417.
- Ravallion, M. and G. Datt., 2000. When Growth is Pro-Poor? Evidence from the Diverse Experience of Indian States, The World Bank, Policy Research Working Paper #2263.
- Richardson, W, Harry, 1978. *Regional and Urban Economics*. Penguin Books. Great Britain : The Chausess Press Ltd.
- Rosen, H.S., and T. Gayer, 2008. *Public Finance*, Eighth Edition. Singapore and New York, McGraw-Hill International Edition.
- Safdari, Mehri, and Elahi, 2011. Impact of Human Capital on Economic Growth in Iran. *European Journal of Economics, Finance and Administrative Sciences*. ISSN 1450-2275 Issue 41 (2011). © EuroJournals, Inc. 2011. <http://www.eurojournals.com>
- Sen, A., 1999. *Employment, Tachonology, and Development*, Indian ed. Oxford University Press, New Delhi.
- Sepulveda, Cristian F., 2010, *The Consequences of Fiscal Decentralization on Poverty and Inequality*, George State University.
- Shelly, Gary L., and Wright, David B., 2008. Incremental State Higher Education Expenditures. *International Atlantic Economic Society*, 2008.
- Solow, R.M., 2000. *Growth Theory: An Exposition*. New York, Oxfodr University Press.
- Son HH and Kakwani N 2004, "Economic Growth And Poverty Reduction: Initial Conditions Matter", Working Paper No 2 International Poverty Centre, UNDP,
- Soubbotina, T.P. 2004. *Beyond Economic Growth (An Introduction to Sustaianable Development)*. The World Bank : Washington, D.C
- Sumner, Andy, 2012, *The Evolving Composition of Poverty in Middle-Income Countires: The Case of Indonesia 1991-2007*, IDS Working Paper, Volume 2012 No. 409.
- Tachiwou, Aboudou Maman, 2011. Infrastructure Development and Economic Growth in Togo. *International Journal of Economics and Finance*, Vol. 3. No. 3. 2011.
- Tang, Chor Foon and Lai, Yew Wah The Causal Relationship between ealth and Education Expenditures in Malaysia. *Theoretical and Applied Economics Volume XVIII* (2011), No. 8(561), pp. 61-74
- Todaro, Michael, P., dan Smith, SC. 2003. *Economic Development*. Eighth Edition. Pearson Education.
- Todaro , Michael, P., 2004. *Pembangunan Ekonomi di Dunia Ketiga*. Penerbit Erlangga Edisi Kedelapan, 2004.
- Tresch, R.W., 2008. *Public Sector Economics*. New York, Palgrave Macmillan.
- Tri, Maryani, 2011. *Analisis Indeks Pembangunan Manusia di Provinsi Jawa Tengah*, Tesis, UPN Veteran, Yogyakarta.
- UNDP, 2006. *Beyond Scarcity: Power, Poverty and The Global Water Crisis*. Human Development Report 2006. New York, UNDP.

- Van Den Berg, H. 2005. *Economic Growth and Development: An Analysis of Our Economic Achievements and Our Most Exciting Challenges*. Singapore and New York, McGraw-Hill International Edition, Economic Series.
- Vanegas, Manuel 2014. *The triangle of poverty, economic growth, and inequality in Central America: does tourism matter?* Department of Applied Economics, University of Minnesota, Falcon Heights, Minnesota, USA
- Wodon, Quentin T., 1999. *Growth, Poverty, and Inequality: A Regional Panel for Bangladesh*, The World Bank, Policy Research Working Paper #2070, March.
- World Bank. 1994. *World Development Report: Infrastructure for Development*. Oxford University Press, New York.
- World Bank, 2007c. *Analisis Pengeluaran Publik Papua: Sebuah Tinjauan Umum Keuangan Daerah dan Pelayanan Publik Pada Wilayah Tertinggal DI Indonesia*. Pemda Papua, Support Office For Eastern Indonesia (SofEI), The World Bank.
- Yao, Guevera Assamoi, 2007, *Fiscal Decentralization and Poverty Reduction Outcomes: Theory and Evidence*, George State University.
- Xie, D., Zou, H. and Davoodi, H. 1999. "Fiscal decentralization and economic growth in the United States", *Journal of Urban Economics*, 45(2), , 228–39.
- Zaman, Miethy, 2012. *Human Capital and Economic Growth: An empirical investigation using panel data*, (MSc Student, Economics, University of Nottingham, United Kingdom). *IOSR Journal Of Humanities And Social Science (JHSS)*. ISSN: 2279-0837, ISBN: 2279-0845. Volume 4, Issue 6 (Nov. - Dec. 2012), PP 43-56 www.iosrjournals.org.



The Moderating Role of the Legal Environment on the Relationship between TMT Characteristics and Organizational Performance in a Regulatory Setting in Kenya

Joseph O. Oketch¹, James M. Kilika², Godfrey M. Kinyua³

¹ Department of Business Administration, School of Business, Kenyatta University, Nairobi, Kenya. Email: jseph.oketch@gmail.com

² Department of Business Administration, School of Business, Kenyatta University, Nairobi, Kenya. Email: jmkilika@gmail.com

³ Department of Business Administration, School of Business, Kenyatta University, Nairobi, Kenya. Email: jefkinyua@gmail.com

Abstract

The legal environments of regulatory agencies are key predictors of their organizational performance as they influence how the regulatory agencies are created, their mandates, sources of funding and reporting frameworks. Reporting frameworks include the nature of the relationships between the regulatory agencies and the policy makers, political actors, the legislature, the executive, judicial processes, regulated entities and the public. The specific objective of the study was to establish the moderating effect of the legal environment on the relationship between top management team characteristics and organizational performance of the independent regulatory agencies in Kenya. To achieve this objective, the study adopted descriptive cross-sectional research design. The target population of the study was all the twenty-three state regulatory agencies currently existing in Kenya. Due to the uniqueness of each independent regulatory agency and the distinct roles played by each top management team member in their organization, the study adopted a census survey of all the top management team members in all the twenty three state regulatory agencies in order to capture the required information. Primary data was gathered using structured questionnaire administered through drop and pick later method. Descriptive statistics was then used to summarize the survey data into percentages, frequencies, means and standard deviations. Whisman and McClelland model was used to test for the moderation. The findings of the study showed that legal environment has significant moderating effect on the relationship between top management team characteristics and performance of the independent regulatory agencies in Kenya. The study recommends that the independent regulatory agencies should have stable funding mechanism so as not to rely on the parent ministries or exchequer support for them to be financially independent in executing their mandates. Lastly the study recommends for judicial system to recognize and support the work of the independent regulatory agencies in enforcement of the laws and regulations for their sectors or sub-sectors.

Keywords: Top Management Team Characteristics, Legal Environment, Independent Regulatory Agencies, Organizational Performance

1.0. Introduction

The external environment influences organizations as they make and execute strategic decisions aimed at propelling them to superior organizational performance regardless of the industry of their businesses (Hitt, Ireland, Sirmon & Trahms, 2011). According to Mkalama (2014), organizations today face external environments that are very dynamic and all the times filled with uncertainty. Several previous strategic management scholars have thus argued that to competently deal with the uncertainties presented by their external environments and to remain strategically focused so as to exhibit exemplary performance, organizations must always scan their external environments and fully understand the situations presented. Organizations must therefore build capabilities and core competences in order to counter the negative effects presented by their external environment while taking advantage of all the opportunities available (Njoroge, Ongeti, Kinuu & Kasomi, 2016). For the independent regulatory agencies, the legal environment gives them their mandates, defines their institutional structures and funding sources, and outlines their relationships to the sectors they regulate. The legal environment, therefore, sets the foundations for all their activities and beacons for evaluating their performance. It has been observed by previous strategic management scholars that the legal environments in all countries are becoming very volatile as governments try to enact legislations to match the ever changing expectations of their citizens and business landscapes due to globalization (Kikoyo, 2014).

The laws passed by governments and international laws adapted by a country for business operations form the legal environment of organizations in that country. The legal environment thus includes all the laws, regulations and government policies or directives that provide the relational systems between political power and any business. All countries or governments desire to regulate business activities within their borders. The legal environment therefore decides the limits for business operations. According to governments, the legal environment is meant to ensure a climate of political and legal stability, which should encourage desired businesses while discouraging the un-desired businesses and help in avoiding risks to either the citizens or the business entities (Voiculet, Belu, Parpandel & Rizea, 2010). The legal environments of regulatory agencies are mostly influenced by how the regulatory agencies are created, their mandates, sources of funding and reporting frameworks. Reporting frameworks include the nature of the relationships between the regulatory agencies' and the policy makers, political actors, the legislature, the executive, judicial processes, regulated entities and the public (OECD, 2013). Kikoyo (2014) conceptualized legal environment of regulatory agencies from three main dimensions namely; government policies for the sectors being regulated, laws in the country that form the regulatory agencies and the regulations that operationalizes the laws, and lastly the judicial systems in the country that deal with enforcement of laws. According to Christensen (2004), the greatest legal environmental challenge faced by regulatory agencies result from weak foundations of regulatory reforms and the intricate trade-off between political control and independence of the regulatory agencies.

Top management team characteristics refer to unique personal traits ascribed to members of the TMT that are either inborn or acquired, noticeable or perceptive. They are predictors of the worth of the TMT members in carrying out their tasks and managing their organizations (Mkalama, 2014). Previous scholars have grouped top management team characteristics into three categories namely, demographic characteristics, cognitive characteristics and psychological characteristics (Kasomi, 2015). Demographic characteristics are the observable or readily detectable features such as age, gender, education level, functional backgrounds and tenure. Psychological characteristics refer to subjective attributes such as personality traits and personal attitudes and beliefs such as self-esteem, self-efficacy, locus of control, emotional stability, task specific self-efficacy, optimism and resilience. Cognitive characteristics are associated with the ability of the TMT member to learn, remember, problem-solve and pay attention as they carry out their tasks (Kinuu, 2014).

Superior organizational performance is the most sought after outcome by all organizations be they public, private, national or multi-national, profit or non-profit organizations. However the definition of organizational performance remains to be a prickly subject among strategic management circles with various scholars and practitioners defining organizational performance differently (Kasomi, 2015). Javier (2002) while contributing to the subject, defined organizational performance in terms of economic, efficient and effective utilization of organizational resources in its activities. This is closer to what Daft (2000), suggested by postulating organizational

performance to be the capacity of the organization to realize its objectives and attain its goals through utilizing its assets in a proficient and appropriate way. Ricardo and Wade (2001), in their argument viewed organizational performance as the capability of an organization to maximize on its strengths while overcoming its weakness and to neutralize its threats while taking advantage of opportunities in order to achieve its objectives and goals.

Independent regulatory agencies in Kenya are a special category of state corporations with oversight role over their sectors or sub-sectors. They license operators, set prices where necessary, protect consumers, enforce compliance to licence conditions and market rules, enforce standards as well as codes of practice for the industry. They are meant to spur growth and improve services to consumers or end-users of the services in their particular industries. Currently there are twenty three (23) independent regulatory agencies in Kenya although there are plans to merge some of them so as to make them more efficient and effective. The management of the independent regulatory agencies in Kenya is bestowed on their board of directors and top management teams. Selection and identification of the top management teams with the requisite characteristics for each regulatory agency has been identified as an aspect that affects their performance (PTRP, 2013). Previous studies on performance of state corporations in Kenya have identified that some top management teams are deficient of appropriate talents that can enable implementation of suitable strategic management practices that could positively influence the performance of their organizations. Some of the top management teams have also been associated with failure of their organizations to align themselves to their ever changing and demanding business environments (Mkalama, 2014). The variation in the performance of the independent regulatory agencies have also been attributed to several other factors like; utilization of resources, poor identification of stakeholders and their needs, lack of sufficient resources, in appropriate organization structures and weak corporate governance structures (Ongeti, 2014).

2.0. Statement of the Problem

The Legal environment of state regulatory agencies are mostly influenced by how the regulatory agencies are created, their mandates, funding sources and institutional frameworks. The legal environment also defines the kind of association between the regulatory agencies and the various arms of government like the policy makers, the legislature, the executive and the judiciary as well as the regulated entities and the general public (OECD, 2013). Lack of clarity of roles, mandates and resources to the independent regulatory agencies are some of the factors that negatively affect their organizational performance (Stern, 2010). It has been argued that the institutional frameworks of the independent regulatory agencies have unclear or duplicate reporting lines that lead to ambiguity on the roles that the agencies ought to play in their various sectors or sub-sectors. On paper, the state regulatory agencies are meant to be independent and to have oversight roles over the regulated entities in their sectors or sub-sectors while the government ministries deal with policy. This has not been the case as the government still has strong control over the independent regulatory agencies as well as some of the regulated entities (GoK, 2013). This study therefore opted to investigate the moderating role of the legal environment on the relationship between TMT characteristics and performance in a regulatory setting in Kenya.

3.0. Literature Review

3.1. Theoretical Review

The advocates of open systems theory have argued that firms are influenced by what goes on in their external environments as they conduct their businesses. This is premised on the postulation of Ansoff & McDonell (1990) that organizations are environment serving and dependent. It is therefore necessary that organizations adapt or create a strategic fit with their environment if they are to sustain superior organizational performance (Njoroge, 2015). External environment has been considered by previous strategic management scholars to consist of interlinked sets of situations that play crucial roles in shaping the prospects, risks and limitations that organizations face and that impinge on their activities hence affecting their organizational performance. The external environment consists of situations originating beyond the organization's operating sphere and can be broadly categorized into legal, economic, political, social and technological forces. These factors are commonly designated as macro- environment (Pearce and Robinson, 2007). The other elements of the external environment are the situations influencing immediate operating sphere of the organization also denoted as micro-environment or industry forces. The micro-environment comprise of the labour markets, customers, suppliers, creditors, and trade

unions. They either encourage or limit the accomplishment of set organizational goals and impinge on the internal operations of the organization thus affecting its objectives and strategies (Gupta, 2009).

The legal environment influences organizations as they make and execute strategic decisions aimed at propelling them to superior organizational performance regardless of the industry in which the organizations operate in (Hitt, Ireland, Sirmon & Trahms, 2011). According to Mkalama (2014), organizations today face external environments that are very dynamic and all the times filled with uncertainty. Organizations must always therefore fully comprehend the different situations presented by their external environment to competently deal with the uncertainties presented in order to remain strategically focused and to thrive. Organizations must hence build capabilities and core competences to assist them in countering the negative effects presented by their external environments while taking advantage of all the opportunities available (Njoroge, Ongeti, Kinuu & Kasomi, 2016). The study of the moderating role of the legal environment on the relationship between TMT characteristics and performance in a regulatory setting in Kenya was therefore anchored on the open systems theory.

3.2. Conceptual and Empirical Review

Previous strategic management researchers have argued that it is crucial for organizations to synchronize themselves to the changing environmental conditions in order to thrive. They have asserted that organizations must continuously scan their environments to identify opportunities to exploit and threats to mitigate against so that they gain or maintain sustained competitive advantage. Thus the structure and characteristics of the environments where organizations operate have been identified to be vital for their organizational performance (Kirkbesoglu, 2012). The legal environment has been argued to provide a model for organizational life as it constructs important roles for organizational actors and impacts positively or negatively to their operations by establishing norms that penetrates into the organizational life. Thus, organizations must conform to their legal environment for them to remain relevant and to be allowed to remain in business. The structures and processes of organizations are therefore shaped in such a way as to comply with the dictates of their legal environments (Kikoyo, 2014). Although the component of environment has been scrutinized ostentatiously in several studies on different spheres, studies on the relationships between organizations and their legal environments remain to be limited.

According to Wheelen and Hunger (2009), strategic management process in organizations can be divided into four inter linked phases namely, environmental scanning, strategy formulation, strategy execution, and strategy evaluation and control. Environmental scanning is meant to assist the organizations identify openings and risks that are likely to affect the organizations' activities negatively or positively in the short term and long term. The external environment of organizations has been conceptualized by previous strategic management researchers to include political, legal, economic, social and technological factors that impinge on operations of the organizations. These scholars have viewed external environment as a provider of resources and information that are vital for the survival of organizations (Marcus, 2011).

According to Nogal-Meger (2018), one aspect of the legal environment is the regulatory enforcement framework. The study operationalized regulatory enforcement framework in terms of how objectively and meritoriously regulations are instigated and administered. The researchers argued that regulations set legal and organizational structures within the particular industries being regulated by governments. They therefore asserted that the regulatory enforcement framework aspect of the legal environment sets how government regulations are effectively applied and their influence on the regulated entities and the economy in general.

The study further highlighted that regulatory proceedings must be promptly conducted to ensure there are no arbitrary delays and that due process must be followed in the regulatory proceedings. According to the researchers, the second aspect of the legal environment is the concept of the rule of law that protects against manifestations of arbitrariness and sets standards of accountability for the entities involve in applying the regulations. The focus of the current study therefore was to investigate the influence of the legal environment on organizational performance of state regulatory agencies in Kenya. This is because the legal environment of the independent regulatory agencies gives them their mandates, defines their institutional structures as well as their relationships with the sectors or sub-sectors they regulate.

The greatest legal environmental challenge faced by regulatory agencies result from weak foundations of regulatory reforms and the intricate trade-off between political control and independence of the regulatory agencies. The current study therefore conceptualized the legal environment in terms of sector policies, Acts of parliaments or presidential directives and sector or sub-sector regulations (Christensen, 2004). The study categorized TMT characteristics into three sub-variables namely, TMT demographics, TMT psychological and TMT cognitive characteristics. The study hence operationalized TMT demographic characteristics in terms of age, education, functional background, tenure (Carpenter, 2002) and gender representation (Dezso & Ross, 2012). Likewise the study operationalized TMT psychological characteristics in terms of self-esteem, general self-efficacy, optimism, emotional stability, task specific self-efficacy, resilience and locus of control (Kinuu, 2014). TMT cognitive characteristics was operationalized terms of problem solving, attention, memory and learning (Bouquet, Morrison & Birkinshaw, 2003). Lastly the study operationalized organizational performance in terms of effectiveness, efficiency, relevance and financial viability (Muraga (2015).

The study thus conceptualized a relationship as revealed by reviewed literature on the effect of legal environment on the relationship between TMT characteristics and organizational performance. In the conceptual model below, TMT characteristics is the independent variable while organizational performance of the independent regulatory agencies is the dependent variable, while the legal environment is the moderating variable. These relationships are captured in the schematic model in Figure 2.

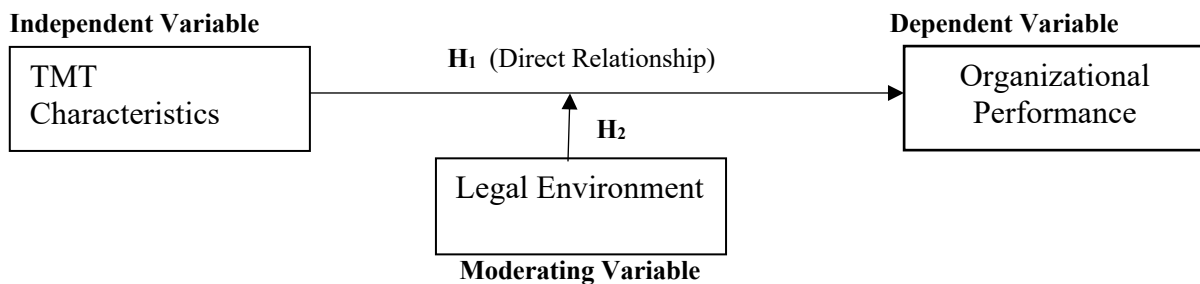

Figure 2: Conceptual Framework

Based on the logic presented in the conceptual framework, the authors proposed that the legal environment would moderate the effect of TMT characteristics on organizational performance of the independent regulatory agencies in Kenya. Specifically, the study proposed that;

Hypothesis H₁: TMT characteristics has a significant effect on organizational performance.

Hypothesis H₂: The Legal environment has a significant moderation effect on the relationship between Top management team characteristics and organizational performance of the independent regulatory agencies in Kenya.

4.0. Research Methodology

The study adopted positivist research philosophy since it delved to look at what causes the particular relationships and what the effects of these relationship are. Positivism philosophy favours quantitative methods where considerable amount of data is gathered for analysis (Muchemi, 2013). Positivist philosophy was also considered appropriate for the study as the researchers were independent of the phenomena being investigated and the properties of the occurrences under study were objectively measured (Mugenda & Mugenda, 2003). The study used a cross-sectional survey design because cross-sectional surveys enable collection of data across a large number of organizations at one point in time for analysis. In a cross-sectional survey research design, the desired data for each variable in the study can be collected from the entire population or a section of it to help test the research hypotheses (Njoroge, 2015). Other researchers like Mkalama (2014), Muchemi (2013), Ongeti (2014) and Kasomi (2015) while trying to test hypotheses and draw conclusions in similar studies have also used cross-sectional survey design successfully.

The study context was the independent regulatory agencies in Kenya. According to the presidential task force on parastatal reforms (PTPR) of 2013, Kenya had a total of one hundred and seventy-eight (178) state corporations spread across eighteen (18) government ministries as at 30th June 2013, out of which twenty three (23) were the independent regulatory agencies (GoK, 2013). The unit of analysis for this study was the twenty three (23) state regulatory agencies while the unit of observation was two hundred and thirty two (232) TMTs spread across the twenty three (23) independent regulatory agencies in Kenya. The researchers used a census of all the 232 TMTs from all the state regulatory agency as each was considered to have unique information relating to how the characteristics of the TMTs affected performance of their independent regulatory agencies. Primary data was collected using a structured questionnaire comprising of closed ended questions. The questionnaire was developed in line with the objectives and hypotheses of the study and guided by the literature review as well as theories underpinning the various study variables. Data on the variables were measured using a five point Likert scale ranging from "not at all" (1) to (5) "to a very large extent." The positive responses were validated, edited for completeness and consistency upon receipt in order to prepare them for statistical analysis. Descriptive and inferential statistics were then used to analyze the prepared data. Diagnostic tests of normality, multi-collinearity and homoscedasticity were carried out on the study data. The results confirmed that there were no violation of the assumptions of linear regression analysis that could result in biased estimates, over or under confident estimates of the precision of regression coefficients and untrustworthy confidence levels and significance tests (Chatterjee & Hadi, 2012). The test for the moderation effect adopted the 2 steps approach postulated by Whisman and McClelland (2005).

Step 1: The influence of TMT characteristics on Organizational Performance

The first model in the moderation was deployed to investigate the combined effect of the TMT characteristics on organizational performance.

$$\text{Organizational Performance} = \beta_{10} + \beta_{11} \text{ TMT Characteristics} + \varepsilon \dots\dots\dots 1$$

Step 2: Effect of TMT characteristics on Strategy Execution

The second step involved regression analysis of organizational performance on TMT characteristics, legal environment, and the interaction term between TMT characteristics and legal environment.

$$\text{Organizational Performance} = \beta_{70} + \beta_{71} \text{ TMT Characteristics} + \beta_{72} \text{ Legal Environment} + \beta_{73} \text{ TMT Characteristics} * \text{ Legal Environment} + \varepsilon \dots\dots\dots 2$$

Where; β_{ii} = Beta coefficient

ε = Error term

The inferential statistics included regression model summary, ANOVA and regression coefficients of the independent variables. The hypotheses were tested at 0.05 level ($\alpha=0.05$), hence where the calculated p value was less than 0.05, the model was established to be statistically significant and the study failed to reject the null hypothesis but where the calculated p value was greater than 0.05, the model was established to be statistically insignificant and the study rejected the null hypothesis.

5.0. Research Findings

5.1. Respondents Characteristics

The researchers distributed 232 questionnaires, out of which 166 were responded to positively. This represented an overall response rate of 71.6%. The respondents were from 19 state regulatory agencies out of the targeted 23, representing 82.6% involvement of the state regulatory agencies in Kenya. Similar previous studies conducted in the Kenyan context by Muchemi (2013) and Muraga (2015) had comparable response rates of 72.5% and 72.1% respectively. According to Mugenda and Mugenda (2003), 50% response rate is considered adequate, 60% good and above 70% very good. Very good response rates yield results that can be better inferred to a population

(Awino, 2011). Therefore, the study response rate was adjudged to be very good and appropriate. The respondent's characteristics are as shown in table 1.

Table 1: Respondents' Characteristics

Category	Number	Percentage
Designation		
CEO	10	6.0
Director/GM	45	27.1
Head of Department	84	50.6
Deputy Head of Department	1	0.6
Head of Section	24	14.5
Others	2	1.2
Total	166	100
Gender		
Male	115	69.2
Female	51	30.8
Total	116	100
Age		
30 and Below	1	0.6
31 - 35	5	3.0
36 - 40	9	5.4
41 - 45	47	28.3
46 - 50	65	39.2
51 - 55	34	20.5
Above 55	5	3.0
Total	116	100
Education		
Bachelors	19	11.4
Masters	131	79.0
PhD	16	9.6
Total	166	100
Tenure		
0 - 5	82	49.4
6 - 10	66	39.8
11 - 15	14	8.4
16 - 20	1	0.6
Over 20	3	1.8
Total	166	100
Functional Area		
Support	101	60.8
Technical	65	39.2
Total	166	100.0

The statistics in table 1 show that majority of the respondents were heads of departments at 50.6% (84) followed by directors/general managers at 27.1% (45), heads of sections at 14.5% (24), CEOs at 6.0% (10), others at 1.2% (2) and lastly deputy heads of departments at 0.6% (1). The findings in table 1 therefore demonstrated that all of the respondents were CEOs and those directly reporting to them as the top management team was conceptualized in the study. The summarized statistics presented in table 1 further show that the respondents were not fairly distributed across gender. There were more male respondents at 69.2% (115) than female respondents at 30.8% (51). For age distribution of the respondents, majority were in the age bracket 46-50 at 39.2% (65) followed by 41-45 at 28.3% (47), 51-55 at 20.5% (34), 36-40 at 5.4% (9), a tie of 31-35 and above 55 at 3% (5), and lastly 30

and below at 0.6% (1). Concerning the highest level of education, majority of the respondents had master's degrees at 79% (131), followed by bachelor's degrees at 11.4% (19) and Ph.D. at 9.6% (16). On the functional area of the respondents, support functions which had many departments had majority of the respondents at 60.8% (101) while technical departments which had few departments had 39.2% (65).

5.2. The Variable Characteristics

The descriptive statistics of the study variables comprising of the number of items used to measure the variables, Cronbach's alpha (α), aggregate mean score and aggregate standard deviation are as shown in table 2.

Table 2: Descriptive Characteristics

Variable	No. of Items	(α) Score	Aggregate Mean	Aggregate Std Dev.
TMT Demographic Characteristics	16	0.859	3.684	0.867
TMT Cognitive Characteristics	9	0.944	4.175	0.745
TMT Psychological Characteristics	24	0.867	4.570	0.430
Legal Environment	12	0.831	4.090	0.868
Organizational Performance	28	0.949	4.190	0.787

The descriptive statistics presented in table 2 show that the Cronbach's alpha was 0.859 for demographic characteristics, 0.867 for psychological characteristics, 0.944 for cognitive characteristics, 0.831 for legal environment and 0.949 for organizational performance that were all greater than the threshold Cronbach's alpha value of 0.7 adopted by the study, thus the research instrument passed internally consistency test. The overall aggregate mean score for demographic characteristics was 3.684 that indicates that the respondents on average agreed to a moderate extent that the attributes of the demographic characteristics applied to their independent regulatory agencies while the standard deviation of 0.867 indicates that there were considerable variations within and among the state regulatory agencies. The overall aggregate mean score for psychological characteristics was 4.175 with a standard deviation of 0.745 that indicates that on average the respondents agreed to a large extent with the attributes under psychological characteristics as pertains to their job performance in their current roles while the standard deviation indicates that the responses for psychological characteristics were more clustered around the mean scores than were the scores for demographic characteristics. The overall aggregate mean score for cognitive characteristics was 4.57 with a standard deviation of 0.430 that indicates that on average the respondents agreed to a large extent with the attributes under cognitive characteristics as pertains to their job performance in their current roles while the standard deviation indicates that the responses for cognitive characteristics were more clustered around the mean scores than were the scores for both demographic characteristics and psychological characteristics. The overall aggregate mean score for the legal environment was 4.090 that indicates that the respondents on average agreed to a large extent that the attributes of the legal environment applied to their independent regulatory agencies while the standard deviation of 0.868 indicates that there were considerable variations within and among the state regulatory agencies. Lastly, the overall aggregate mean score for organizational performance was 4.190 that indicates that the respondents agreed to a large extent that the attributes of organizational performance applied to their independent regulatory agencies while the standard deviation of 0.787 indicates that there were considerable variations within and among the independent regulatory agencies.

5.3. Test of Hypotheses

The test of the research hypotheses was conducted was on stages. First, the study tested the direct effect of TMT characteristics on organizational performance of the state regulatory agencies. In order to test the hypotheses, a composite index of the various components of TMT characteristics was computed using the formula proposed by Kilika (2012) based on the harmonic mean.

5.3.1. Test of Hypothesis One

This hypothesis sought to understand whether there is any statistically significant effect of the combined effect of TMT characteristics on the performance of the independent regulatory agencies in Kenya. The regression analysis output is summarized in in table 3.

Table 3: Regression of Organizational Performance on TMT Characteristics

Model Summary						
Model	R	R Square	Adjusted R Square	Std. Error of the Estimate	Durbin-Watson	
1	.556 ^a	.309	.305	.37618	2.049	
ANOVA						
Model		Sum of Squares	df	Mean Square	F	Sig.
1	Regression	10.378	1	10.378	73.335	.000 ^b
	Residual	23.208	164	.142		
	Total	33.586	165			
Coefficients						
Model		Unstandardized Coefficients		Standardized Coefficients	t	Sig.
		B	Std. Error	Beta		
1	(Constant)	1.030	.361		2.853	.005
	Combined TMT Characteristics	.763	.089	.556	8.564	.000

The results indicate that TMT characteristics explain 30.5% of the variation in organizational performance of the independent regulatory agencies in Kenya. The other 69.5% of the variation is attributed to other factors not included in the empirical model. The F statistic of 73.335 with a p-value of 0.000 indicates that the regression model is significant in predicting this relationship. The summarized statistics in table 3 further show that the beta coefficient for the constant (β_0) is 1.030 with a t statistics of 2.853 and a p value of 0.005 while the standardized beta coefficient for the combined TMT characteristics (β_1) is 0.556 with t statistics of 8.564 and p-value of 0.000. Since the p-value is less than the significance level of 0.05, combined TMT characteristics was found to be a significant predictor of organizational performance. The β_0 of 1.030 implies that with the combined TMT characteristics held constant, organizational performance will be at 1.030 while β_1 of 0.556 indicates that if all other factors are constant, a unit change in the Top management characteristics would result to 0.556 change in organizational performance. Hypothesis one is therefore supported and the study concluded that TMT characteristics has a significant statistical effect on organizational performance of the independent regulatory agencies in Kenya.

5.3.2. Test of Hypothesis Two

This hypothesis sought to understand whether there is any statistically significant moderating effect of the legal environment on the relationship between TMT characteristics and organizational performance of the independent regulatory agencies in Kenya. To evaluate the moderation effect of legal environment on the relationship between TMT characteristics and organizational performance. Two steps regression analysis was conducted in accordance with the moderation model proposed by Whisman and McClelland (2005). The results from the four steps are summarized in table 4.

Table 4: Summary of Regression Results for the Moderating Effect

Parameter	Step 1	p-Value	Step 2	p-Value	Change	Decision
R ²	0.309	-----	0.533	-----	0.224	Legal environment has moderating effect on the relationship between TMT characteristics and organizational performance.
Adjusted R ²	0.305	-----	0.527	-----	0.222	
F Statistics	73.335	0.000	85.471	0.000	12.1336	
β Constant	1.030	0.005	1.889	0.000	0.859	
β TMT characteristics	$\beta_{61}=0.556$	0.000	$\beta_{71} = 0.505$	0.000	-0.051	
β Legal environment	-----	-----	$\beta_{72} = 0.446$	0.000	-----	
β Interaction Term	-----	-----	$\beta_{73} = 0.589$	0.000	-----	
<u>Necessary Condition for Moderation</u>						
$\beta_{61} = 0.556, P = 0.000$ hence Significant						
$\beta_{72} = 0.446, P = 0.000$ hence Significant						
$\beta_{73} = 0.589, P = 0.000$ hence Significant						

From the above summary of findings in table 4, the beta coefficient of TMT characteristics reduced from 0.556 in step 1 to 0.505 in step 2 implying a reduction of 0.051 units. The model was fit at $F = 85.471, p = 0.000$. For step 1, the adjusted R² was 0.309 while for step 2 the adjusted R² was 0.527, implying an overall increase of adjusted R² by 0.222 units. The results thus implies that the percentage of the dependent variable explained by variables in the regression model increased by 22.2% in step 2. According to McClelland and Whisman (2005), a tested moderator is said to be an explanatory variable if the coefficient changes from significance to non-significance. However, the tested moderator is said to have moderating effect if the interaction term coefficients remains significant. The decision on the hypothesis was made using the criteria recommended by Fairland and MacKinnon (2009) that states that if the regression coefficient of the interaction term is statistically different from zero, there is evidence of significant moderation of the relationship between independent variable and the dependent variable. Since $\beta_3 = 0.589$ at $t = 9.859$ and $p\text{-Value} = 0.000$, it is statistically different from zero and significant. Therefore the study rejected the null hypothesis and concluded that legal environment has significant moderating effect on the relationship between top management team characteristics and performance of independent regulatory agencies in Kenya.

6.0. Discussion of Findings

The conclusion of this study can be explained by the descriptive statistics, results from previous researchers and the open systems theory. From descriptive statistics, the three sub-variables under legal environment of sector policies, Acts of parliament/presidential directives and regulations had aggregate mean scores of 3.92, 4.18 and 4.10 respectively with the overall aggregate mean score for the aspects of the legal environment investigated at 4.09 with a standard deviation of 0.868. This means that the respondents to a large extent agreed with the attributes that were measured under the legal environment. In dealing with the legal environment, the context of the study is key as businesses may be in the same kind of legal environment but get affected differently. Like commercial businesses and state corporations, although operating in the same legal environment, will feel the effects differently, this is also true for independent regulatory agencies.

The findings support the postulates of the open systems theory that external environments affects organizations as they conduct their businesses, or in other words, organizations are environment serving and dependent. Top management teams in organizations are responsible for carrying out the business activities of their organizations in order to achieve desirable performance but in carrying out the activities, TMTs must identify opportunities and threats in their environments. They must thus possess attributes to enable them sense and to take actions necessary either to exploit the opportunities or neutralize the threats. For independent regulatory agencies, the legal environment defines their powers and functions that their TMTs use to achieve their objectives and goals.

The findings of the current study are consistent with the observation made by Mkalama (2014), that laws that create and define the mandates of the state corporations and other laws of the land are considered important to the decisions taken and consequently performance of the state corporations. The findings are also consistent with the observation by Njoroge (2015) that external environment moderated on the relationship between strategy implementation and performance of state corporations in Kenya.

7.0. Contribution of the Study

The findings of the current study thus fill the gap identified in the empirical literature review that in investigating the influence of TMT characteristics on organizational performance, it is important to include other variables that affect the relationship. Because TMTs work within legal and institutional frameworks in pursuit of their organizations' mandates, missions and visions in order to achieve the desired organizational outcomes, legal environment is therefore one such variable that affects the relationship between TMT characteristics and organizational performance. The established moderating relationship therefore adds knowledge to strategic management research and practice.

8.0. Conclusions and Recommendations

From the findings of the study reported, the research makes three conclusions. First, that the respondents on average agreed to large extent that the attributes of legal environment applied to their independent regulatory agencies, Second, that the finding could be explained by the fact that the sector policies or presidential directors and Acts of parliament gives the independent regulatory agencies their mandates, funding mechanisms and their institutional arrangements, while regulations gives the independent regulatory agencies their oversight role over the regulated entities and the sectors. The study likewise makes two recommendations. First, that the independent regulatory agencies should have clear institutional frameworks with clearly defined relationships with the government and their regulated entities and industry. Second, that for judicial system to recognize and support the work of the independent regulatory agencies in enforcement of the laws and regulations for their sectors or sub-sectors.

References

- Ansoff, H. I. & Mc Donnell, E.J. (1990). *Implanting Strategic Management*, 2nd Ed., NY: Prentice Hall.
- Awino, Z.B. (2011). *Strategic Management: An Empirical Investigation of Selected Strategy Variables on Firm Performance: A Study of Supply Chain Management in Large Private Manufacturing Firms in Kenya. Prime Journals, 1(1): 9-18.*
- Christensen, T. (2004). *Regulatory Agencies: The Challenges of Balancing Agency Autonomy and Political Control. Stein Rokkan Centre for Social Studies; Working Paper No. 18.*
- Daft, R.L. (2000). *Organization Theory and Design, (7th Ed.)* South-Western College Publishing, Thomson Learning, U.S.A.
- Government of Kenya, (2013). *Sector Plan for Public Sector Reforms 2013 – 2017*
- Gupta, A. (2009). *Organization external environment. Retrieved from <http://www.practical-management.com>.*
- Hitt, M.A., Ireland, R.D., Sirmon, D. G. & Trahms, C. A. (2011). *Strategic Entrepreneurship: Creating Value for Individuals, Organizations and Society. The academy of management perspectives, 25(2): 57-76.*
- Javier (2002). *A review paper on Organizational Culture and Organizational Performance. International. Journal of Business and Social Science, 1(3): 52-76.*
- Kasomi. F. M., (2015). *Diversity in Top Management Teams, Strategic Choice, Top Manager's Compensation Schemes and Performance of Kenyan State Corporations. (Ph.D. Thesis), University of Nairobi, Department of Business Administration, School of Business, Nairobi.*
- Kikoyo, O. I. (2014). *The Impact of Legal Framework on Regulatory Authorities in Tanzania: A Case Study of the Surface and Marine Transport Regulatory Authority (SUMATRA). (PhD Thesis). The Open University of Tanzania.*
- Kilika, J. M. (2012). *Institutional context, collaboration, human resource development infrastructure and performance of universities in Kenya. (Ph. D Thesis), School of Business, University of Nairobi.*
- Kinuu, D. (2014). *Top Management Team Psychological Characteristics, Institutional Environment, Team Processes and Performance of Companies listed in Nairobi Securities Exchange. (PhD Thesis), University of Nairobi, Department of Business Administration, School of Business, Nairobi.*

- Kirkbesoglu, E. (2012). Strategic Reactions of Organizations to Legal Environment: A Typology for Industries in the Process of Institutionalization. *International Journal of Business, Humanities and Technology*, 2(3).
- Marcus A. A. (2011). *Management Strategy: Achieving Sustained Competitive Advantage*, McGraw-Hill Company, America.
- Mkalama, R. N., (2014): Top Management Team Demographics, Strategic Decisions, Macro-Environment and Performance of Kenyan State Corporations. (*PhD Thesis*), University of Nairobi, Department of Business Administration, School of Business, Nairobi.
- Muchemi, W.A., (2013). Top Management Team Diversity and Performance of Commercial Banks in Kenya. (*PhD Thesis*), University of Nairobi, Department of Business Administration, School of Business, Nairobi.
- Mugenda, O.M. & Mugenda, A.G. (2003). *Research Methods: Quantitative and Qualitative Approaches*. Nairobi: ACTS Press.
- Muraga, D. K. (2015). *Strategic Human Resource Management Practices and Performance of Parastatals in Kenya*. (*Ph. D Thesis*), Kenyatta University
- Njoronge, J. K., (2015). Strategy Implementation, Performance Contracting, External Environment and Performance of Kenyan State Corporations. (*PhD Thesis*), University of Nairobi, Department of Business Administration, School of Business, Nairobi.
- Njoroge, J. K., Ongeti, W. T., Kinuu, D. & Kasomi, F. M. (2016). Does External Environment Influence Organizational Performance? The Case of Kenyan State Corporations. *Management and Organization Studies* 3(3). Retrieved from <http://mos.scieducpress.com>.
- Nogal-Meger, P. (2018). The Quality of Business Legal Environment and Its Relation with Business Freedom. *International Journal of Contemporary Management*, 17(2): 111–136. doi:10.4467/24498939IJCM.18.021.8545.
- OECD. (2013). *Principles for the Governance of Regulators*. OECD Publishing, Paris. Retrieved from <http://Regulators.comment@oecd.org>.
- Ongeti, W. J., (2014). Organizational Resources, Corporate Governance Structures and Performance of Kenyan State Corporations. (*PhD Thesis*), University of Nairobi, Department of Business Administration, School of Business, Nairobi.
- PTPR, (2013). *Report of the Presidential Taskforce on Parastatal Reforms*. Retrieved at www.apsea.or.ke/.../76-report-of-presidential-taskforce-on-parastatal-reforms.
- Ricardo, R. and Wade, D. (2001). *Corporate Performance Management: How to Build a Better Organization through Measurement driven Strategies alignment*. Butterworth, Heinemann.
- Stern, J. (2010). The Evaluation of Regulatory Agencies. *Centre for Competition and Regulatory Policy (CCRP)*, City University London. Working Paper No 16.
- Voiculet, A., Belu, N., Parpandel, D. E. & Rizea, I.C. (2010). *The Impact of External Environment on Organizational Development Strategy*. Munich Personal RePEc Archive.
- Wheelen, L. T. & Hunger, J. D. (2009). *Strategic Management and Business Policy Concepts and Cases* Eleventh Edition, Prentice-Hall International, USA.
- Whisman, M. A. & McClelland, G. H. (2005). Designing, Testing, and Interpreting Interactions and Moderator Effects in Family Research. *Journal of Family Psychology* 19(1): 111-120.



Prioritization of Storm Water Drain Construction for an Urban Area in the Chittagong Hill Tracts Region of Bangladesh

Md. Mohirul Islam Mohir¹, Shaolin Shawon²

¹Master of Science in Water Resources Development, BUET, Dhaka, Bangladesh.

E-mail: mohirbuet@gmail.com

²Master of Science Research Student, Department of Physics, BUET, Dhaka, Bangladesh.

E-mail: mss.buet@gmail.com

Abstract

Developing the urban drainage system is now a common issue in most developing countries like Bangladesh. Due to rapid urbanization, drainage related problems are identified as high priority by Municipal residents. Therefore, Municipal Drainage System needs to be developed in such a way that it functions in the long term resulting optimization of the used resources. Storm water flood hazard due to inadequate drain is a major concern in the Municipalities in the Chittagong Hill Tracts (CHT) Regions of Bangladesh. To address the issue, drainage master plans have been prepared for the three Municipalities in the CHT under the Urban Governance and Infrastructure Improvement Project (UGIIP) of Local Government Engineering Department (LGED) funded by Asian Development Bank (ADB). Under this master plan, 78 independent drains are proposed that would be implemented over a period of 10 years. The problem of the master plan implementation is that the available fund for drain construction in each year is a fraction of the total requirement. Considering the situation, the aim of the study is to develop a priority ranking schedule for drain construction. Development of the Multi-Criteria framework for prioritization of storm drain works is the methodology for this research. The outcome of the research is the year-wise implementation schedule of drain construction over the planning period based on available funds for a particular year.

Keywords: Multi-Criteria Analysis, Drain Deficiency, Social Vulnerability, Priority Ranking

1. Introduction

Stormwater flood hazard is a growing concern in urban areas of the Chittagong Hill Tracts (CHT) of Bangladesh. The flood damage is increasing with the change in land use due to the expansion of urban areas. Because of hill topography, flooding occurs in a very short time, and the hazard is quite severe due to flash floods. The existing drains are inadequate to drain the storm runoff. With the financial assistance of ADB, drainage master plans have been prepared for three Municipalities in the CHT under the UGIIP project LGED. One of those is the Drainage Master Plan for Bandarban Municipality (LGED, 2006a). The storm runoff of Bandarban Municipality is discharged to the Sangu river that flows through the town (Figure 1). There is 26.9 km of storm drains in the Municipality Area. A total of 17.8 km of new drains has been proposed in the Master Plan (LGED, 2006a).

Geographically, Bandarban Municipality is a high land area and the town experiences flash floods of different extent almost every year. The magnitude of flood hazard depends on multiple factors such as hydrological, topographical, land use, socio-economic and environmental characteristics of the catchment. Therefore, the Multi-Criteria approach is essential for decision making regarding prioritization of storm drain works. Multi-criteria decision making in water management planning has been emphasized in the National Water Policy (Ministry of Water Resources, 1999). Development of the Multi-Criteria framework for prioritization of storm drain works is the ultimate goal under this study.

2. Materials and Methods

A questionnaire survey has been carried out to assess public response to stormwater flood hazards. The survey has covered 190 households which were obtained on the basis of statistical sampling formula. The distribution of 190 households among 9 Wards is in the proportion to Ward population. The purpose of the survey is to assess the flood situation and its consequences. The respondents identified the location of the flood-affected area, causes of the stormwater flood and public life disruption due to storm waterflood.

Area-elevation relationship has been developed based on the contour map of the study area. The volume-elevation relationship has been derived from the area-elevation relation. A rainfall depth of 123 mm has been used to estimate runoff volume. Based on runoff volume, the flooded area has been identified using volume-elevation and area-elevation relationships. Besides flooding, runoff ways along hill slope areas make disruption to the public and private properties. The runoff ways along hill slope areas have been identified based on the contour map.

A total of 78 independent drains with a length of 17.8 km have been proposed in the Master Plan for Bandarban Municipality. Five criteria have been selected to represent storm flood hazards that would serve as the basis for prioritization of drain construction. These criteria are drain deficiency, flood magnitude, population suffering, damage characteristics, and social vulnerability. The magnitude of five criteria has been calculated for every drain. The standardized value of each criterion is added for a drain to get a total score for the drain with the help of the Linear Additive Model. The scores of 78 drains are ranked in order of decreasing magnitude, and the rank represents priority order. The series of 78 ranks is to be divided into 10 segments to set the year-wise implementation schedule of 78 drains over 10 years. The segments are to be such that the total drains in a segment can be implemented using the budget for that year.

3. Objectives of the Study

The objectives of the study are as follows :

- i) to predict inundation area and consequent damage due to stormwater flooding in the selected urban area in the CHT, and
- ii) to develop indicators for multi-criteria assessment of storm flood hazard for the prioritization of storm drain construction over the planning period in the study area.

4. Chittagong Hill Tracts

Chittagong Hill Tracts (CHT) is the main hill area in Bangladesh and it is covered by tertiary hills. It is located in the southeast part of the country (Figure 1), comprised of Rangamati, Khagrachari and Bandarban hill districts and consists of 25 upazilas of Bangladesh. The population of CHT is 13,42,740 (BBS, 2001). It has an area of 13,180 sq.km, making up approximately 10% of the total area of Bangladesh. Although the population density in this region is as low as 102 persons/sq.km, the ratio of cultivable land per person in CHT region is only 1.04 hectare as most part of the region is covered with numerous hills, ravines, cliffs and dense vegetation (LGED, 2006b). The soils are characterized by low fertility. Tasing-Dong, the highest peak of Bangladesh is located in the Bandarban district.

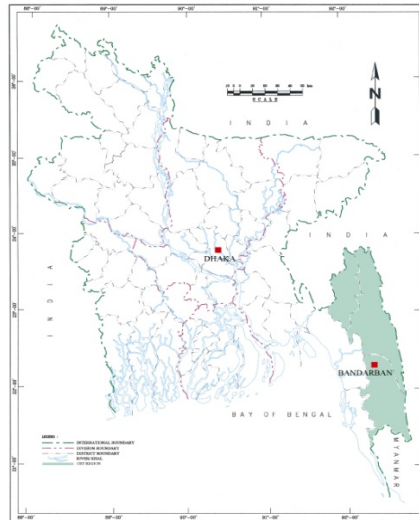

Figure 1 : Chittagong Hill Tracts Regions of Bangladesh

The tribal people who differ culturally from the majority population of Bangladesh are predominantly Buddhists, with small numbers of Hindus. They differ linguistically and in their social organization, marriage customs, birth and death rites, food, agriculture techniques and other social and cultural customs from the people of the rest of the country. According to numbers, the Chakma remains the dominant followed by Marma, Tripura, Tanchangya, Mro, Bawm, Khyang, Pankhu, Khumi, Lushai, Chak and others.

5. Study Area

Bandarban, Khagrachari, and Rangamati were originally a sub-division of Chittagong Hill Tracts District. Bandarban sub-division emerged as a district on the 4th April 1981 and Bandarban Municipality was established in May 1984. Drainage master plans have been prepared for Bandarban, Rangamati and Khagrachari Municipalities in the CHT under the Urban Governance and Infrastructure Improvement Project (UGIIP) of Local Government Engineering Department (LGED). Considering the availability of secondary data and maps, Bandarban Municipality has been selected as the study area.

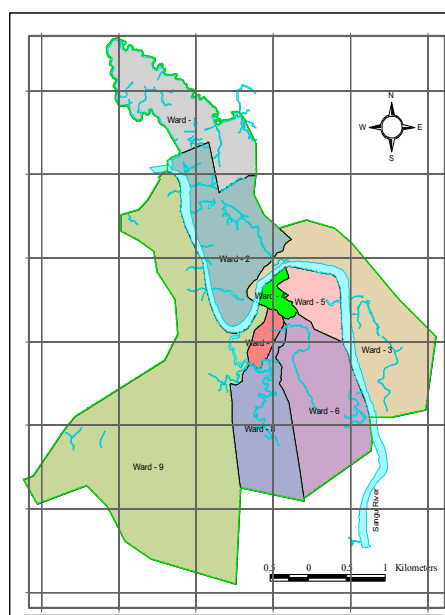

Figure 2 : Bandarban Municipality of Bangladesh

6. Existing Storm Drains

To drain the storm runoff from urban catchments, some drains have been constructed. There is 26.89 km of storm drains in the Bandarban Municipality area. The drain system in Bandarban Municipality is not network type. There is no branching. Every drain is a single branch drain and discharges stormwater individually from a particular catchment directly to khal / river. Major portion of the drains have been constructed with the Government contribution to development program. Also during recent years, drains have been implemented under the Municipal Service Project (MSP) of LGED. The distributions of existing drains among different wards are presented in Table 1.

Table 1 : Distribution of existing storm drains of Bandarban Municipality

Ward No	Existing Drains		Proposed Drains	
	No of drains	Total Length (m)	No of drains	Total Length (m)
1	5	1535	20	4400
2	7	3794	03	535
3	6	2051	10	1699
4	20	1367	05	614
5	16	2681	14	3475
6	17	7380	08	3316
7	9	3724	05	1407
8	4	1603	05	1067
9	5	2750	08	1280
Total	89	26885	78	17793

Source : LGED, 2006a

7. Introduction to Multi-Criteria Analysis

Multi-Criteria Analysis (MCA) is a decision-making tool developed for complex multi-criteria problems that include qualitative and quantitative aspects of the problem in the decision-making process (Mendoza and Macoun, 1999). It is the formal technique recommended for evaluating strategies and ranking them according to multiple decision criteria. MCA is a comprehensive and effective means of structuring a decision problem by providing a transparent method of determining objectives and criteria. It serves as an ideal platform for participatory planning, involving stakeholders, technical experts and analysts. Another important advantage of MCA is that it does not require all effects to be translated into a common unit of value or significance. This allows the analyst to work with different kinds of indicators and units of measurement. National Water Policy of Bangladesh (Ministry of Water Resources, 1999) has emphasized multi-criteria decision making in water management.

8. Steps of Multi-Criteria Analysis

The following steps are generally followed for conducting a Multi-Criteria Analysis:

- a) Determination of the scores with respect to the criteria
- b) Determination of the standardized scores
- c) Determination of the weights for criteria
- d) Ranking based on the total score

In Multi-Criteria Analysis, the score of each criterion is multiplied by the weight of that criterion and then all those weighted scores are added together to get overall value.

9. Scale of Criteria Measurement

Five criteria have been selected to assess extent of storm flood hazard. List of criteria and their indicators is given in Table 2. A scale of 0 to 20 has been adopted for every criteria so that the range of total score based on five

criteria becomes 0 to 100. The values of the criteria have been standardized to express their magnitude in the range of 0 to 1. Then the standardized value has been multiplied by 20 to bring in the scale of 0 to 20. Logic behind the criteria selection and the procedure followed to estimate their magnitude are discussed in the following section.

9.1 Drain Deficiency Criterion

Absence of drain is the main cause of storm waterflood. The shortage of drain in a Ward is the indicator of drain deficiency. The Ward with a greater shortage is likely to be more prone to storm floods. Therefore the Ward with less drain facility should get higher priority in drain construction.

This criterion has been calculated by the following equation.

$$DD_k = [1 - (E_k / T_k)] * 20 \quad \dots \dots \dots \rightarrow (1)$$

Where, DD_k = Drain Deficiency in the k-th Ward

E_k = Length of existing drain in meter in the k-th Ward

P_k = Length of proposed drain in meter in the k-th Ward

T_k = Length of total requirement of drain in meter in the k-th Ward
 $= E_k + P_k$

9.2 Flood Magnitude Criterion

Flood hazard is also dependent on flood magnitude which is reflected by flooded area and depth of flood. The intensity of hazard increases with the increase of flood depth. It has been known from the consultation meeting with local people that no damage has been occurred for less than 0.3m flood depth. A minimum flood depth of 0.3m has been considered as a threshold value for flood hazard. The magnitude of this criterion has been standardized by dividing by the largest value among all drain catchments. This criterion has been calculated by the following equation.

$$FM_i = (A_i / A_{max}) * 20 \quad \dots \dots \dots \rightarrow (2)$$

Where, FM_i = Value of flood magnitude criterion for the catchment of i-th drain.

A_i = Area in hector in the catchment of i-th drain subject to flood depth of at least 0.3m or runoff way in hills

A_{max} = Maximum value of A_i among all drain catchment.

9.3 Population Suffering Criterion

People living in the area subject to storm flood suffer directly by the flood. This type of suffering is a major concern. The number of people in the flooded area of the catchment of drain has been considered as an indicator of this criterion. But it is a difficult task to measure the actual number of people in the flooded part of a catchment of a proposed drain. To overcome the problem, the population density of a Municipality's Ward as per Community Series of Bangladesh Bureau of Statistics (BBS, 2001) has been used to estimate the number of people in the flooded area. The area subject to flood is multiplied by population density of a Ward to get the number of the population exposed to flood. The magnitude of these criteria has been standardized by dividing by the largest value among all drain catchments.

This criterion has been calculated by the following equation.

$$PS_i = (NP_i / NP_{max}) * 20 \quad \dots \dots \dots \rightarrow (3)$$

Where, PS_i = Value of population suffering criterion for the catchment of i-th drain.

NP_i = Number of population exposed to flooding or runoff way in hills in the catchment of i-th drain.

NP_{max} = Maximum value of NP_i among all drain catchments.

9.4 Damage Characteristics Criterion

Flood damage depends on the land use distribution in the flooded area. So the land use distribution in the flooded area has been taken as the indicator of flood damage characteristics. Land use has been grouped into three categories: commercial, residential and agricultural/forest. Storm flood damage data is not available for Bandarban Municipality. Weighting factors for different land use categories have been estimated based on observed damage cost per unit land area for land use categories in Dhaka City (JICA, 1991). The estimated weighting coefficients are 0.60, 0.33 and 0.07 for commercial, residential and agricultural / forestry land use respectively. The magnitude of the damage characteristic criterion has been standardized by dividing by the largest value among all drain catchments. This criterion has been calculated by the following equation.

$$DC_i = (DM_i / DM_{max}) * 20 \quad \dots\dots\dots \rightarrow (4a)$$

$$DM_i = A_{c-i} * 0.60 + A_{r-i} * 0.33 + A_{a-i} * 0.07 \quad \dots\dots\dots \rightarrow (4b)$$

Where,

DC_i = Value of damage characteristics criterion in the catchment of the i-th drain.

DM_i = Value of damage for flooding in the catchment of i-th drain.

A_{c-i} = Area in hectare of the Commercial Land in the flooded catchment or runoff way in hills of the i-th drain.

A_{r-i} = Area in hectare of the Residential Land in the flooded catchment or runoff way in hills of the i-th drain.

A_{a-i} = Area in hectare of the Agricultural / Forest Land in the flooded catchment or runoff way in hills of the i-th drain.

DM_{max} = Maximum value of DM_i among all drain catchments.

9.5 Social Vulnerability Criteria

The poor people, particularly the slum dwellers, are most vulnerable to flood hazards. It takes quite a long time for them to recover from the disruption due to flood hazards. The equity principle emphasizes attention to vulnerable sections of the society because of their inability to withstand the adverse impacts of hazards. So the slum area needs special attention in flood hazard management. The Poverty Reduction Strategy Paper (Planning Commission, 2005) also emphasized access to physical infrastructure facilities for poor women, slum-dwellers and poor neighborhoods.

The total population of slum areas in Bandarban Municipality is 2,380 and the total number of households is 567 as discussed in section 2.3.3. There are 29 slums in Bandarban Municipality which are characterized by a severe lack of basic amenities like roads, drainage, street light, dustbins, water supply, tubewell, sanitary latrines and others (LGED, 2005a). The slum dwellers suffer from different types of diseases. To improve the environment of the slum area, storm drainage facilities need to be implemented on a priority basis. The number of slum households in the catchment of a drain has been collected from Poverty Reduction Action Plan (LGED, 2005a).

Social vulnerability criterion has been calculated along with standardization by the following equation.

$$SV_i = (NS_i / NS_{max}) * 20 \quad \dots\dots\dots \rightarrow (5)$$

Where, SV_i = Value of the social vulnerability criterion for the catchment of the i-th drain.

NS_i = Number of slum households in the catchment of i-th drain.

NS_{max} = Maximum value of NS_i among all drain catchments.

Table 2 : Criteria and Indicators for Flood Hazard Assessment

Criteria	Indicator
Drain Deficiency	Shortage of drain in percent of total requirement
Flood Magnitude	(a) Area subject to runoff way in hill slope area
	(b) Area subject to at least 0.3m of flood depth
Population Suffering	(a) Number of population in the runoff way in hill slope area
	(b) Number of population in the flooded area
Damage Characteristics	(a) Landuse distribution in the runoff way in hill slope area
	(b) Landuse distribution in the flooded area.
Social Vulnerability	Number of slum household in the catchment of proposed drain.

10. Procedure of Multi-Criteria Prioritization of Drain Works

The storm drain network in Bandarban Municipality consists of individual drain system. There is no branching in the network. Every individual drain discharges directly to the canal or river. Every proposed drain ranked separately based on the following equation.

$$S_i = DD_k + FM_i + PS_i + DC_i + SV_i \quad \dots \dots \dots \rightarrow (6)$$

Where S_i is the score of the i -th drain. Values of the five indicators in the right hand side of the equation have been calculated based on equation (1) to (5). Values of DD_k are equal for all drains in the k -th Ward. The scale of S_i is 0 to 100.

11. Priority Ranking of Drain Construction

The steps of calculation are shown shortly in Figure 3.

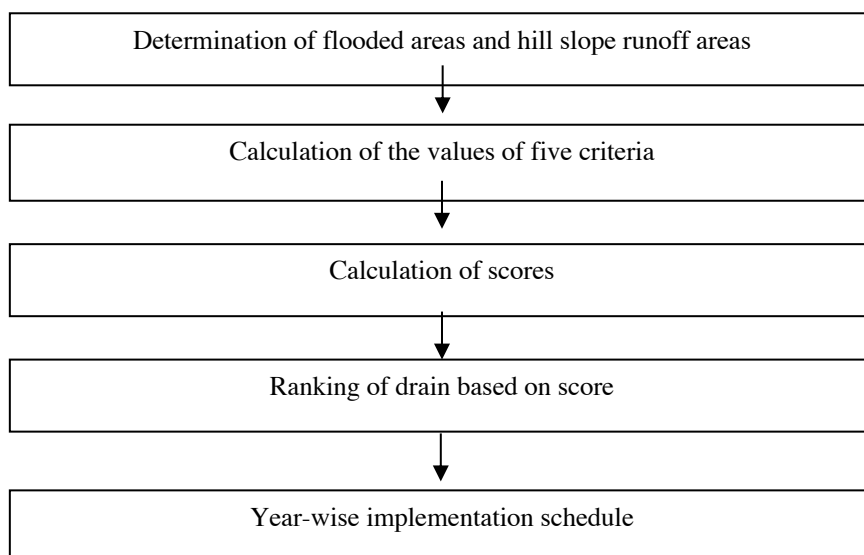

Figure 3 : Main Steps of Multi Criteria Prioritization

12. Year-wise Implementation Schedule

How many drains can be constructed in a year is dependent on the available budget for that year. So the year-wise implementation schedule of drain construction over the planning period is to be determined based on year-wise budget. The ranked series of drains are to be divided into segments, and the number of segment is equal to the

number of year in the planning period. The segmentation is to be made such that the total drain length in a segment can be implemented using the budget available for the year.

Table 3 : Storm Drain Implementation Schedule

Implementation Year	Drain to be constructed in different Wards									
	W-1	W-2	W-3	W-4	W-5	W-6	W-7	W-8	W-9	Total Length (m)
1 st						60				2.70
2 nd	17		25		50, 44	54	64			1.93
3 rd	1				49	55		66	75, 72	1.62
4 th	3		24		43, 41, 51, 40					1.71
5 th	20, 12, 18		26, 29, 27		45, 42			67, 68		1.90
6 th	14, 10, 16, 19, 15, 8	21			52		65		78, 77, 73	1.78
7 th	11, 7, 9				39		61, 63	69		1.52
8 th	2, 4, 6		32, 31	35, 36			62		71	1.72
9 th	13, 5	22	33, 30, 28		46, 47, 48	58, 57		70		1.75
10 th		23		38, 37, 34		53, 56, 59			78, 74	1.16
Total Length (m)	4.40	0.54	1.70	0.61	3.48	3.31	1.40	1.07	1.28	17.79

13. Conclusion

Storm water flood hazard during monsoon is a major concern in Bandarban Municipality. Responses received from 190 households during a questionnaire survey, reveal that 33 out of 67 paras get flooded during monsoon. The main causes of floods are the absence of drain and lack of proper operation and maintenance of drain. The major consequences are an inconvenience to movement, damage due to intrusion of floodwater into home/market and environmental sufferings.

To overcome the problem of the non-availability of the data on flooded areas, the prediction of the flooded area has been made based on the contour map. Prediction for a rainfall of 123 mm shows that 5.32% areas of the topographic zones get flooded. Major portion of non-flooded area is hill area. The high slope areas also suffer from damage because of heavy runoff flow.

Main outcome of this study is the development of a multi-criteria decision aid to determine the priority order of the storm drain to be constructed in the future. Five criteria have been selected to represent storm flood hazards that serve as the basis for prioritization. The criteria are drain deficiency, flood magnitude, population suffering, damage characteristics, and social vulnerability. The 78 new drains that are to be constructed over 10 years in Bandarban Municipality, has been ranked in priority order by applying the method. The ranked series is to be divided into 10 segments such that the total length of drains in a segment can be implemented using the budget available for the year corresponding to that segment.

References

- BBS (2001), Bangladesh Bureau of Statistics, Community Series, Bandarban District.
- Chaw, V.T., Maidment, D.R., and Mays, L.W. (1988), Applied Hydrology, McGraw Hill Pub Co. New York.
- JICA (1991), Master Plan for Greater Dhaka Protection Project (Study in Dhaka Metropolitan Area), FAP 8A, Main Report and Supporting Reports I & II, FPCO, Dhaka.
- LGED (2005a), Socio-Economic Survey for Bandarban Municipality, ADB Assisted Urban Governance and Infrastructure Improvement Project, LGED, Dhaka.
- LGED (2006a), Drainage Master Plan for Bandarban Municipality, ADB Assisted Urban Governance and Infrastructure Improvement Project, LGED, Dhaka.
- LGED (2006b), Chittagong Hill Tracts Census Indicators 2001 & Trends (1981-2001), Geographical Information System (GIS) Unit, LGED, Dhaka.
- Ministry of Water Resources (1999), National Water Policy, Government of the People's Republic of Bangladesh.
- Mendoza, G. A. and Macoun, P. (1999), Guidelines for Applying Multi Criteria Analysis to the Assessment of Criteria and Indicators, the Criteria & Indicators Toolbox Series, Published by Center for International Forestry Research (CIFOR), Jakarta Indonesia.
- Planning Commission (2005), Unlocking the potential, National Strategy for Accelerated Poverty Reduction, Planning Commission, Government of the People's Republic of Bangladesh.



Risk Management: Comparative Study between Islamic Banks and Conventional Banks

Zainul Kisman¹

¹Universitas Trilogi. Email: zainulkisman@trilogi.ac.id

Abstract

In the future the role of Islamic Banking / Sharia should be developed as an alternative source of corporate financing in addition to conventional bank financing. The role of this institution is increasing because based on survey Islamic Development Bank for certain types of risks attached to Islamic Bank is relatively easier to manage it compared with conventional banks. Easier risk management results in lower financing risks, making it easy to compete because it is profitable for banks, corporations and the economy. The survey results show that in Islamic Bank: Capital is quite good, Capital and Liquidity risk is low. Credit, market and operating risk moderate. More concerned about credit and liquidity risk. The most commonly used risk management techniques are Credit rating.

Keywords: Risk Management, Islamic Bank, Conventional Bank

I. Introduction

Banks in accordance with Islamic law have long been present as alternatives to conventional financial institutions. The presence of this institution is, among others, providing services relating to investment or financing based on Sharia (Dahlan, 2005; Dendawidjaya, 2000)). The increasingly globalized and increasing world trade results in increasingly large competition and risks faced by the business world. Increased risk results in banks, both conventional and sharia being demanded to be able to compete in serving the business world so that the transaction risks they face can be minimized (IDB, 2001). In order to provide financial services (financial services) with low costs, conventional and Islamic banks are required to be able to issue contracts and instruments that can minimize financial risk.

The extent to which Sharia Banks can compete compared to its competitors in the future depends on how the institution manages its operational and other inherent risks.

The purpose of this paper is as follows:

- In the first part, it is a preliminary background that explains how important the role of Islamic banks is in supporting business world financing as an alternative to financial institutions conventional.
- The second part discusses the unique characteristics of the risk of Islamic banks compared to conventional banks.

- In the third part, explain the results of a research survey from the Islamic Development Bank on the risk management practices of the Islamic Bank.

II. Unique Characteristics of Sharia Bank Risk.

In its activities, banks face risks that have the potential to cause losses. According to Kisman and Shintabelle (2015) along with Kisman (2016), there are risks that can be avoided or minimized (unsystematic risk) and some that cannot be avoided (systematic risk). For this unavoidable risk, banks are required to be able to manage it without reducing the expected return. In order to achieve this goal, bank management is required to understand risk and how to manage it.

According to the Islamic Development Bank (2001), Olsson (2002), Jorion (2002) and William et al (2009) risk is the probability of an event occurring that can cause a loss. When an undesirable event occurs, it will cause a loss if not anticipated and managed properly.

For banks, these risks are events or events that can be either anticipated or not, which can harm the bank both for its income and its capital today or for the future or for the future. In overcoming this problem banks must continuously observe developments in both their internal and external conditions (Robock et al, 1983).

Not only conventional banks face this risk problem but also Sharia banks are also demanded to be able to manage risk, starting from identifying it, measuring it up to controlling it.

Viewed from the environment that affects banks, the risk is divided into two:

- (1) Systematic Risk, which is the risk that comes from macro situations: political situation, government economic policy, changes in market conditions, recession.
- (2) Unsystematic Risk, namely risks originating from within the company itself, micro risk and this type of risk can be minimized by diversification.

Judging from the bank's business activities, the risks in this bank can be grouped as follows:

- (1) Credit Risk (Financing Risk or Financing risk in Sharia banks)
- (2) Market Risk
- (3) Liquidity Risk
- (4) Operational Risk
- (5) Legal Risk
- (6) Reputation Risk
- (7) Strategic Risk
- (8) Compliance Risk

(1) Credit Risk

Risk, which is a loss experienced by banks because the debtor is unable to pay the loan principal or interest on the loan. The risk of default is due to banks being too aggressive so that they ignore the prudential banking principle. And aggressiveness occurs because of the possibility of banks experiencing overvalued conditions so that they are overshadowed by fears of rising cost of loanable funds.

Credit risk also arises due to conditions in the real sector that are sluggish or not conducive. The features decreased and the cash flow was not sufficient to pay the interest and principal of the loan. Rising interest rates that result in increased lending rates or base lending rates also contribute to non-performing loans. Credit risk is increasing for banks because the collateral is inadequate and even worse the legal status is unclear. All these problems will make it difficult for the bank when it is going to restructure credit or when it is carried out.

Conventional banks that most of their income comes from loan interest income, conventional banks are required to pay considerable attention to this credit problem and its distribution. An increase in bad loans means that banks

must increase their capital. If the owner is unable to make additions, the bank's permission will be revoked. So credit risk here raises capital risk.

For a Sharia bank, this credit risk (or it is called in a Sharia Bank as Financing Risk) is a specific problem. For example:

- (a) The bank has delivered the goods but the payment was not made according to the agreement. (Murabahah)
- (b) The bank failed to provide goods according to the agreement (both time, quality and specifications).
- (c) Banks run the risk of damage to goods rented/leased (Ijarah).

(2) Market Risk

Losses experienced by bank portfolios due to changes in market variables such as interest rates, inflation, and exchange rates.

(3) Liquidity Risk

Liquidity shows the ability of banks to meet their obligations which will soon mature in the short term. The bank is liquid if it can meet its funding needs immediately to meet the needs of its depositors. The not liquid bank will cause a decrease in bank credibility which will ultimately cause the bank to be rushed and bankrupt.

In Indonesia, this liquidity risk problem for conventional banks is easier to overcome compared to Islamic banks. Because conventional banks can easily overcome it by entering the interbank call money market. As with Islamic banks, although there are sharia interbank money market but participants is still limited as well as its volume.

(4) Operational Risk

These risks include human errors, system failures, and inadequate procedures and controls that will affect bank operations. Included in this risk are errors in information systems, internal controls, human errors, system failures, and inadequate procedures and controls.

(5) Legal Risk

The loss of a bank due to bank for lawsuits, weaknesses in legal or juridical aspects. Lack of regulations, legislation and weak contracts.

(6) Reputation Risk

Risk due to the bank's declining reputation or the existence of negative publications or wrong perceptions about banks.

(7) Strategic Risk

Risk experienced by banks because the bank fails to implement its strategy. For example, it failed in achieving the target set. The failure occurred due to a lack of sensitivity of banks to changes that occur in their environment.

(8) Compliance Risk

Risk of losses that occur because banks do not comply with the provisions or regulations in force. Both internal provisions (from company management) and external (central banks).

Based on Bank Indonesia Report, Islamic banking is unique risks, for example:

- Potential for investment risk (income risk/equity investment risk)
- Specific liquidity risks associated with differences in return (rate of return risk)
- Specific market risks from changes in inventory prices
- Specific legal risks associated with transactions using sharia principles
- Reputational risk is also associated with compliance with sharia principles in bank operations.

III. PROFILE OF RISK MANAGEMENT BANK SYARIAH:**Interpretation of Survey Results of Islamic Development Bank.**

This section will explain the results of a survey of several Islamic banks (28 countries). This survey wants to see the practice of risk management in these financial institutions. The results are as follows:

Table 3.1: Basic Balance Sheet Data

	Number of Observation	Average
Assets (Million \$)	15	494.2
Capital (Million \$)	15	73.4
Cap./Asset ratio (%)	15	32.5
Maturity of Assets		
<1 Years	12	68.8%
1 - 3 Years	12	9.8
> 3 Years	12	21.4

Source: Islamic Development Bank (IDB, 2001).

From table 3.1 above it can be seen that the average of the 15 institutions observed is the average total assets of \$ 494.2 Million with an average Capital of \$ 73.4 Million. The amount of Capital / Asset ratio is 32.5%. This figure for bank size is quite large. This shows that Islamic banks viewed from the capital are quite safe.

At the bottom, it is seen that the structure of Islamic bank assets is dominated by assets with a short-term lifespan of 68.8%. This shows the high liquidity of Islamic banks. High liquidity will usually have an impact on the low profitability of banks.

Table 3.2: Risk Perception - Overall Risk Faced by Islamic Financial Institution

	Average Rank
Credit risk	2.71
Liquidity risk	2.81
Market risk	2.50
Operational risk	2.92

Source: IDB (2001); 1 = not serious 5 = Critically serious

From table 3.2 above it can be seen that in the sharia banks, the highest risk is found in operational risk and lowest in market risk. The high operational risk is due to the fact that banks that have studied the system and procedures are incomplete, so this operational risk often arises. Low market risk indicates the low sensitivity of Islamic banks to changes in the market. Liquidity risk is included in the high category indicating less aggressive Islamic banks in lending.

Table 3.3: Maintaining an Appropriate Risk Measuring, Mitigating, and Monitoring Process Risk Report

Capital at Risk Report	64.7%
Credit Risk Report	70.6
Market Risk Report	29.4
Interest rate Risk Report	23.5
Liquidity Risk Report	76.5
Foreign Exchange Rate Risk Report	41.2
Operational Risk Report	17.6
Country Risk Report	35.3

Source: IDB (2001)

From table 3.3 above, it can be seen that the sharia banks that were studied mostly reported or monitored Liquidity risk and Credit risk. The lowest operational risk is only 17.6%.

Table 3.4: Maintaining an Appropriate Risk Measuring, Mitigating, and Monitoring Process Measuring and Management Techniques

	Percentage of Total
The credit rating of Prospective Investors	76.5%
Gap Analysis	29.4
Duration Analysis	47.1
Maturity Matching Analysis	58.8
Earning at Risk	41.2
Value at Risk	41.2
Simulation Techniques	29.4
Estimates of worst-case scenarios	52.9
Risk-Adjusted Rate of Return on Capital	47.1

Source: IDB (2001)

From table 3.4 it appears that Islamic banks in managing their risks more often use Credit rating in assessing debtors and the second technique in minimizing the risks. do Maturity Matching Analysis. While Gap Analysis and Simulation Techniques are rarely used.

IV. Conclusion

Based on the discussion above, it can be concluded as follows:

1. In the future, the role of Islamic banks needs to be developed as an alternative source of corporate financing besides conventional bank financing.
2. For certain types of risks inherent in Islamic banks, it is relatively easier to manage compared to conventional banks. The low risk of financing has made this bank easy to compete.
3. The survey results show that in Islamic banks:
 - Capital is quite good: Capital risk is low.
 - Low liquidity risk resulting in a low profitability rate.
 - Credit, Liquidity, Market and Operational risk are neither high nor too low (moderate).
 - Of the several types of risk, more concerned with Credit and Liquidity risk.
 - The risk management technique that is often used is Credit Rating.

References

- Siamat, Dahlan; Financial Institution Management, Issue 5, Publisher Institute, FEUI, Jakarta, 2005.
- Dendawijaya, Lukman; Banking Management , Ghalia, Jakarta, 2000.
- Islamic Development Bank; Risk Management, Jeddah, 2001.
- Williams, Smith, and Young (1998). Risk Management and Insurance. 8th Ed. Mcgraw-Hill.
- Olsson, Carl (2002). Risk Management in Emerging Markets. Prentice-Hall.
- Jorion, Philippe (2002). Value at Risk. Mc. Graw-Hill.
- Robock, Stefan H. & Kenneth Simond. (1983). International Business and Multinational Enterprises. 3rd Ed. Irwin



Analysis of the Effect of Business Strategy and Financial Distress on Tax Avoidance

Arja Sadjiarto¹, Sylvia Hartanto², Natalia³, Stephani Octaviana⁴

¹Tax Accounting, Petra Christian University, Surabaya, Indonesia. E-mail: arja@petra.ac.id

²Tax Accounting, Petra Christian University, Surabaya, Indonesia. E-mail: sylviahartanto02@gmail.com

³Tax Accounting, Petra Christian University, Surabaya, Indonesia. E-mail: nataliatjahjono09@gmail.com

⁴Tax Accounting, Petra Christian University, Surabaya, Indonesia. E-mail: stephaniocaviana16@gmail.com

Abstract

In recent years, tax avoidance has been frequently discussed and has attracted the attention of the Indonesian government. Many factors affect tax avoidance, one of it is business strategy. Not only business strategies, but also financial distress can also be one of the factors causing tax avoidance. Related to the problem, in this study we would examine the impact of business strategies and financial distress of Indonesian companies to tax avoidance practices. The samples of this research were 292 companies in the manufacturing, trade and construction sectors which were listed on the Indonesia Stock Exchange in period 2015-2018 and obtained 1168 research data. This research used multiple linear regression method. Our regression results proved that the prospector business strategy has a positive impact on tax avoidance, while the defender's business strategy has a negative impact on tax avoidance. Meanwhile, related to financial distress, our results showed that financial distress has a positive impact on tax avoidance.

Keywords: Business Strategy, Corporate Tax Avoidance, Defender, Financial Distress, Prospector

1. Introduction

Tax is one of the biggest income for a country, so tax becomes an object that is highly considered by the government in its fulfillment. Tax has the characteristics as a mandatory contribution of society, where one of the parties who have the obligation to pay taxes is the company whose amount is calculated from the net profit obtained, so if the obtained profit is great, the tax which is paid will be great as well. However, many taxpayers assume that tax payment is a burden, so most people have a tendency to avoid, even they choose not to pay taxes when the opportunity arises. According to Putri and Chariri (2017) generally, tax avoidance is associated with tax planning. Tax planning is a process of taxpayers to minimize their tax debt, whether it is income tax or other tax burden payable.

Before starting a business, a company needs a business strategy that is usually made by managers, where this business strategy affects all company activities (Ariefiara, Utama, Wardhani, & Rahayu, 2015). Business

strategies can make business processes more effective, and make the company more superior than its competitors. Based on research of Miles, Snow, Meyer, & Coleman (1978) there are four types of business strategies of a company, namely: defender, prospector, analyzer, and reactor. In Business strategy doesn't focus on widening the market, launching new products, giving discounts and other similar things only, but also doing a variety of ways to survive. One of the actions that is often taken is to increase revenue or reduce existing expenses, including tax expenses. According to Dhamara and Violita (2018), to reduce the amount of tax paid, companies tend to reduce their pre-tax income through various tax planning strategies.

Besides business strategies, financial distress can also trigger companies to avoid tax. Companies that are in financial distress increase tax aggressiveness to generate additional cash outflows (Richardson, Lanis, & Taylor, 2014). Nugroho and Firmansyah (2017) in their research gave a real example when there is an economic crisis in Indonesia found that many companies experience financial distress or high financial distress so that they are no longer able to maintain the company's survival due to continuous losses, have very large debts and lack of cash to pay off the debt. In the condition of financial distress, companies are required to save capital or meet the minimum capital needed by the company, so that the company is still able to maintain credit ratings, meet the requirements of debt agreements, or continue as a going concern company (Richardson, Taylor, and Lanis, 2015). These demands encourage companies to avoid tax in order to maintain company profits.

Tax avoidance aggressively by companies is not necessarily in line with the wishes of shareholders, which means there is a mismatch between the wishes of shareholders with management behavior that is usually known as agency theory. A company will implement a strategy in accordance with the market conditions that is faced. The business strategy adopted by the company is influenced by decisions taken by the leader. Companies that use different business strategies will face different conditions in the future as well. Therefore, there are companies that are experiencing financial distress due to changes in the implementation of business strategies in their companies. In this contingency theory, the role of the leader is very necessary to understand the conditions being faced by the company and how to overcome the problems that arised.

2. Literature Review

Higgins, Omer and Phillips's research (2011, 2015) examined the relationship between corporate business strategy and tax planning, first, they examined whether business strategy influenced tax avoidance. This research is important to help a better understanding of the factors that influence the tendency of companies to engage in aggressive tax avoidance. This study also uses the typology of Miles and Snow (1987) about business strategy. Higgins found that the prospector did higher tax avoidance than the defender as seen from the lower book and cash ETR and higher permanent book-tax differences. Similar to the research conducted by Martinez and Ferreira (2019), they analyzed the relationship between the types of corporate business strategies and tax aggressiveness with a sample of companies in Brazil. Martinez's research also uses the typology of Miles and Snow (1987) and excludes two strategies namely, analyzer because it is a combination of defender with prospector, and reactors that are considered unstrategic. Different from the study of Higgins et al. (2015), Martinez & Ferreira's research (2019) found that defender companies also have a tendency to be more tax aggressive or take higher tax risk. Wahyuni et al. (2017) also mentioned in their research that business strategy has a significant positive impact on tax avoidance.

In addition to business strategies, research conducted by Richardson et al. (2014) shows that financial distress has a positive impact on tax avoidance practices. Richardson et al. (2014) said that when companies are in financial distress, the benefits of tax avoidance are bigger than the cost savings thereby increasing incentives to avoid taxes. In addition Richardson also believes that financial distress increases incentives for risk reduction behaviors that occur by shareholders and their agents. In the event of financial distress, the strategy previously seen by the company has a high or expensive risk to do, which can be more attractive and feasible as the potential benefits of tax avoidance increase (Richardson et al., 2015). But the results of the study contradict the opinion of Putri and Chariri (2017) which stated that financial distress has a negative impact on tax avoidance practices. Meanwhile, according to Dhamara and Violeta's research (2018) which also examines the impact of financial distress on tax aggressiveness, this study uses a sample of manufacturing companies in Indonesia.

Violita and Dhamara's research results contrast with the research of Richardson et al. (2014), which stated that financial distress does not have a significant impact on tax aggressiveness. This is due to the fact that this research does not cover periods of financial crisis which can increase the chances of financial distress.

This study is different from previous studies because this study combines how business strategy, as well as financial distress, can affect the corporate tax avoidance. This research was conducted on companies which were listed on the Indonesia Stock Exchange in 2015-2018, especially in the manufacturing, trade and construction sectors because these sectors are large sectors and provide a significant contribution to economic growth in Indonesia and also to state revenue in terms of taxation.

2.1 Hypothesis Development

Business strategies have an impact on corporate tax avoidance behavior depending on how the characteristics of each strategic type affect the costs and benefits of tax planning (Higgins et al., 2015). Dunbar and Phillips (2001) argued that prospectors are less in focus on minimizing income tax costs, and thus will outsource more of their tax planning and compliance activities. On the one hand, Higgins et al. (2011) states that Miles and Snow's topologies (1978) showed the potential benefits of tax avoidance are greater for defender companies than for prospector companies because defender companies emphasize cost efficiency as a basis for competitive advantage while prospectors focus more on innovation and growth and less on cost minimization. In particular, defenders are more likely to avoid the risks and uncertainties associated with taking an aggressive tax position. Or, the prospector embraces risk and is better equipped to deal with uncertainties that result from an aggressive tax avoidance strategy. So the researchers formulated the research hypothesis as follows:

H1: Companies with a Prospector strategy are more aggressive in tax avoidance

H2: Companies with a Defender strategy are less aggressive in tax avoidance

When running a business with any strategy, it certainly does not always run smoothly. Many obstacles may be able to hamper the company's growth, one of it is the condition of financial distress. Under these conditions, the company is required to maintain its status as a going concern company. This is what encourages companies to avoid tax in order to maintain company profits because the company considers that tax is a significant cost and cash flow out is significant enough to reduce company profits. Therefore, researchers formulate research with the following hypothesis:

H3: Financial distress has a positive impact on tax avoidance

3. Research Method

3.1 Sample

The determination of the sample in this study came from companies that listed in the manufacturing, trade and construction sectors that are listed on the Indonesia Stock Exchange. This study used a purposive sampling method with criteria according to table 3.1.

Table 3.1 Sample Selection Output

Sample Criteria	Amount	Unit
All companies listed on the Indonesia Stock Exchange 2015-2018	326	Company
Manufacturing, trading and construction companies that publish financial statements for the period 2015 to 2018 using the Rupiah currency.	(20)	Company
Companies that do not have complete variables for research	(14)	Company

Amount of data used as research objects	(292/ 1168)	Company / Data
---	-------------	----------------

3.2 Variables Operationalization

This study used business strategy as an independent variable. The independent variable is an independent variable that affects the dependent variable. As measured using six indexes according to Bentley et al. (2013).

The six indexes are:

1. Ratio of research and development to sales,
2. Ratio of employees to sales,
3. A measure of historical growth (one-year percentage change in total of sales),
4. The ratio of marketing to sales,
5. Employee fluctuation (standard deviation of total employees), and
6. Capital intensity (net PPE measured by total assets).

In addition to business strategy, financial distress in this study is also used as an independent variable measured using the Altman Z Score (Altman & Hotchkiss, 2006), as follows:

$$Z \text{ Score} = 1,2A + 1,4B + 3,3C + 0,6 D + 0,99E$$

Explanation:

A = working capital divided by total assets

B = retained earnings divided by total assets

C = income before interest and tax expense divided by total assets

D = market value equity divided by book value of total debt

E = sales divided by total assets

From the formula above, companies that have a Z score > 2.99 are classified as companies in the safe zone, companies that have a Z score between 1.81 and 2.99 are classified as companies in the gray zone, and companies that have a Z score of <2.99 are classified in the distress zone that has the potential for bankrupt.

The dependent variable used in this study is tax avoidance. Tax avoidance is measured using a cash effective tax rate (CETR), where CETR as paid tax cash is divided by book income before tax. CETR identifies all tax avoidance activities that reduce tax cash, which is paid to the government (Higgins et al., 2011). The following formula for calculating CETR:

$$\text{Cash ETR} = \frac{\text{Cash Tax Paid } i,t}{\text{Pretax Income } i,t} ; i = \text{company} ; t = \text{year}$$

Control variables are variables that are constantly controlled so that the relationship between the independent variable and the dependent variable is not affected by external factors that are not the object of research. The control variables in this study are as follows:

1. Firm Size
Company size is used because larger companies tend to pay higher political costs, including income taxes and often participate in tax planning (Dhamara and Violita, 2018). Firm size is measured using the natural log of total assets in year t.
2. Leverage
Interest costs arising from debt is a reduction in gross income, higher interest costs will have the impact on reducing the company's tax burden (Wahyuni et al., 2017) which has a positive effect and becomes an incentive for a company to carry out tax planning (Cheng, Huang, Li & Stanfield, 2012). Leverage is measured using long-term debt divided by total assets.
3. Return On Asset (ROA)
Company profitability is the company's ability to generate profits which can cause the amount of tax to change from year to year. Companies that have higher profitability also tend to have higher effective tax rates (Dhamara and Violita, 2018). ROA is measured using net income divided by total assets.
4. Capital Intensity

Capital intensity is how big the proportion of fixed assets in the total assets owned. Increasing the company's fixed assets will increase company productivity and company revenue. High ownership of fixed assets will result in high depreciation costs, so the company's tax burden will be reduced (Maulana, Marwa & Wahyudi, 2018). Capital intensity is measured using net PPE divided by total assets.

5. Sales Growth

Sales growth shows development of growth rate from year to year (Wahyuni et al., 2017). The greater sales volume of a company shows that the company's sales growth is increasing. If sales growth increases, the profits generated by the company are assumed to increase. Sales growth is measured using the final sales period minus the initial sales period divided by the initial sales period.

6. Firm Age

Controlling differences in the length of time a company's stock has been traded on the public market (Richardson et al., 2015). Firm age is measured using the age of the company in the year since the company had been founded. From the age of the company can be seen the difference in the experience of a company in reducing tax costs.

3.3 The Model of Analysis

The analytical model used in this study is multiple linear regression. To test the hypothesis of the relationship between business strategy and financial distress against tax avoidance, it will be formulated as follows:

$$\text{CETR} = -5.141 + 0.338\text{PROS} - 0.171\text{DEF} + 0.162\text{FDISTRESS} - 0.004\text{SIZE} - 0.269\text{LEV} + 0.052\text{ROA} + 0.036\text{CAPINT} - 0.009\text{GROWTH} + 3.403\text{AGE} + \varepsilon$$

Explanation:

CETR	= cash effective tax rate (CETR), where CETR as paid cash of tax is divided by book income before tax
PROS	= The prospector business strategy uses six indexes according to Bentley et al. (2013)
DEF	= defender business strategy, using six indexes according to Bentley et al. (2013)
FDISTRESS	= uses the Altman Z Score
SIZE	= natural log of total assets in year t
LEV	= long-term debt divided by total assets
ROA	= net income is divided by total assets
CAPINT	= net PPE is divided by total assets
GROWTH	= the final sales period is reduced by the initial sales period divided by the initial sales period
AGE	= the age of the company in years since the company was founded
ε	= error

4. Result and Discussion

Testing data for this study used a model feasibility test, which included the coefficient of determination test (R^2), simultaneous test (F test), and partial test (T test). Model feasibility test is a test conducted whether the model used to do the regression is correct or incorrect.

4.1 Coefficient of Determination Test (R^2)

The coefficient of determination was used to see how much the independent variable explained the dependent variable using the adjusted R^2 value as the value of the coefficient of determination which ranges from $0 < R^2 < 1$. If the adjusted R^2 value approached the number 1 (one), then the independent variable gives the information needed about the variable dependent. So it could be said that the greater the adjusted R^2 value, the independent variable is better able to explain the dependent variable well.

Table 4.1. Determination Coefficient Table

Model	R	R Square	Adjusted R Square	Std. Error of the Estimate	Change Statistics	
					R Square Change	F Change
1	.188	.035	.028	.85153	.035	4.693

Source: Author's Processed Results Based on SPSS Output

Based on the table, it can be seen that the value of R^2 or coefficient is 0.035. This shows that the independent variables together affect the dependent variable tax avoidance by 3.5% and the rest is explained by other variables not found in this study.

4.2 Simultaneous Test (F Test)

Simultaneous test is used to find out the significant regression coefficient together between the dependent variables namely tax avoidance, independent variables business strategy and financial distress. The results of the F test are as follows:

Table 4.2. Result of F Test

Model	Sum of Squares	df	Mean Square	F	Sig.
1 Regression	30.628	9	3.403	4.693	.000 ^b
Residual	83.676	1158	.725		
Total	870.304	1167			

a. Dependent Variable: CETR

b. Predictors: (Constant), AGE, GROWTH, SIZE, PROS, DEF, FDISTRESS, CAPINT, LEV, ROA

Source: Author's Processed Results Based on SPSS Output

The regression model used shows the significance value of the F test is less than 5% ($P < 0.05$). The regression model is declared feasible to be used to test the hypothesis because it has a significance of less than 0.05. When a regression model is feasible to use, the coefficient of determination (R^2) can be trusted.

4.3 Partial Test (T Test)

T test is used to show how far the influence of one explanatory variable or independent variable individually in explaining the variation of the dependent variable (Ghozali, 2006). The significance of the impact on the results of research in a test can be determined by looking at the significance of the T test, if the T test is smaller or equal to 0.05, it can be concluded that the independent variables and the control variables tested partially have a significant impact on tax avoidance, conversely if the significance results T test is greater than 0.05 then the independent variable partially does not have a significant impact on tax avoidance.

Table 4.3. Result of T Test

Model	Unstandardized Coefficients		Standardized Coefficients	t	Sig.		
	B	Std. Error	Beta				
1	(Constant)	-5.141	1.518			-3.386	.001*
	PROS	.338	.128	.076		2.633	.009*
	DEF	-.171	.045	-.111		-3.815	.000*
	FDISTRESS	.162	.070	.067		2.300	.022*
	SIZE	-.004	.005	-.023		-.782	.434
	LEV	-.269	.136	-.057		-1.974	.049*
	ROA	.052	.085	.018		.616	.538
	CAPTINT	.036	.092	.011		.393	.694
	GROWTH	-.009	.015	-.017		-.599	.549
	AGE	3.403	1.039	.095		3.275	.001*

Source: Author's Processed Results Based on SPSS Output

NOTES: (*) is a significance level less than 0.05 (95% confidence).

The results of T test value on the prospector business strategy variable is 2.633, with a significance level of 0.009, and show a regression coefficient of 0.388. The significance value of this T test has been smaller than 0.05 and the coefficient value is positive. Because the significance is below 0.05, it can be concluded that the prospector business strategy has a positive effect on tax avoidance. The result of this test proved that H1 is accepted, where an increase in the prospector business strategy will increase the level of tax avoidance. Prospector is a business strategy that tends to be active and flexible, where the prospector will try to enter new markets, new consumers, will adjust the intensity of production that follows the changes in consumer taste, and in this case the prospector will always do research. This is due to the focus that the prospector has on finding and maximizing the use of products, markets, and opportunities (Ariefiara et al., 2015). The cost of tax avoidance that must be borne by the prospector is not an obstacle for them, because the prospector gets high income from a broad market share and from the sale of his unique products that can adjust to changes in consumer tastes and trends, so they have few competitors. These are the strengths of the prospector business strategy, so that the cost of tax avoidance doesn't affect the survival of those companies. Therefore, companies with prospector business strategies are found to be aggressive towards tax avoidance.

The results of T test value on the defender business strategy variable is -3.815, with a significance level of 0.000, and shows a regression coefficient of -0.171. The significance value of this T test has been smaller than 0.05. Because the significance is below 0.05 and the coefficient value is negative. Therefore, it can be concluded that the defender business strategy has a negative effect on tax avoidance. The result of this test proved that H2 is accepted, where an increase in the defender business strategy will decrease the level of tax avoidance. Unlike the characteristics of the prospector, the defender tries to dominate the market by providing competitive prices to prevent other competitors from entering the market. Products issued by the defender do not focused on existing

trends, so the costs can be minimized. Tax avoidance activities are very beneficial for defenders because they can minimize the tax burden/tax costs (Arieftiara et al., 2015). Before doing the tax avoidance, certainly needed a plan dan large resources, so the costs are not small. Other than that, tax avoidance allows for tax penalties, tax interest, and risk of uncertainty. Defenders consider the costs more than the benefits of tax avoidance. The cost of tax avoidance will harm the price advantage in the defender's market, so the defender will prefer not to be aggressive in tax avoidance (Higgins et al., 2011).

For the financial distress variable is 2.300, with a significance level of 0.022, and shows a regression coefficient of 0.162. The significance value of this T test has been smaller than 0.05. Because the significance is below 0.05 and the coefficient value is positive, it can be concluded that financial distress has a positive effect on tax avoidance. The results of this test proved that H3 is accepted, where an increase in financial distress will increase the level of tax avoidance. According to Richardson et al. (2015) which also states that financial distress has a positive effect on tax avoidance. Companies that are in a state of financial distress will get more benefits in tax avoidance practices than reducing other company's costs, so the company has no choice than taking a higher risk and become more aggressive in taxation, because it's important for the company to increase their finances, since the tax expense becomes a significant cash outflow for companies in a depressed condition (Richardson et al., 2015). When a company is in a state of financial distress, a strategy that was previously seems risky and expensive, becomes more profitable for the company. Therefore, when the company is experiencing financial distress, the company will be more aggressive in tax avoidance

The results of the T Test for several control variables in this study indicates the value of Leverage (LEV) is 0.049 and Firm Age (AGE) is 0.001 where the value is less than 0.05 (95% confidence), so that Leverage and Firm Age have a significant effect on tax avoidance, where leverage shows a negative relationship with tax avoidance and Firm Age shows a positive relationship with tax avoidance. While the value of firm size (SIZE) is sealed at 0.434, Return on Assets (ROA) is 0.538, capital intensity (CAPINT) is 0.694, sales growth (GROWTH) is 0.549, which is greater than 0.05 so the above variable does not have a significant effect on tax avoidance.

Based on the results of the estimated regression coefficients in the table, the regression model is obtained as follows:

$$\text{CETR} = -5.141 + 0.338\text{PROS} - 0.171\text{DEF} + 0.162\text{FDISTRESS} - 0.004\text{SIZE} - 0.269\text{LEV} + 0.052\text{ROA} + 0.036\text{CAPINT} - 0.009\text{GROWTH} + 3.403\text{AGE} + \varepsilon$$

5. Conclusion

We examine whether business strategies and financial distress has an impact on tax avoidance, where we use the research of Miles et al. (1978) to determine the business strategy under study (prospector and defender) and its measurement using the six indexes of Bentley et al. (2013), for financial distress we measure it with the Altman Z Score and tax avoidance is measured using Cash Effective Tax rate (CETR). So the results of this study indicate that:

1. The prospector business strategy has a positive impact on tax avoidance, which can also be interpreted as a prospector business strategy more aggressive in tax avoidance. So based on the results of the H1 test, it was concluded to be accepted.
2. The defender business strategy has a negative impact on tax avoidance, which can also be interpreted as a defender business strategy that is not more aggressive in tax avoidance. So based on the H2 test results it was concluded that it is accepted.
3. Financial distress has a positive impact on tax avoidance. So based on the results of the H3 test, it was concluded to be accepted.

This research is expected to provide an explanation of whether business strategy and financial distress have a significant effect on tax avoidance and is expected to provide information to companies in Indonesia to choose profitable and safe business strategies so it's not to lead to tax avoidance practices, even in their business activities experiencing financial distress.

Limitation in this study is the usage of formulas for measuring tax avoidance using CETR only. In future studies, it is expected to use several tax avoidance measurement formulas. In addition, we only use samples from the manufacturing, trade and construction sectors listed on the Indonesia Stock Exchange (IDX) in the 2015-2018 period. The next research is expected to pay more attention to the phenomena that are happening right now, especially in Indonesia in order to produce useful research for the readers.

References

- Altman, E.I., & Hotchkiss, E., 2006. *Corporate Financial Distress and Bankruptcy: Predict and Avoid Bankruptcy, Analyze and Invest in Distressed Debt*, Third edition. Wiley, Hoboken, NJ.
- Ariefiara, D., Utama, S., Wardhani, R., & Rahayu, N. (2015). Analisis Pengaruh Strategi Bisnis Terhadap Penghindaran Pajak, Bukti Empiris Di Indonesia. *Simposium Nasional Akuntansi*, 18.
- Bentley, K. A., T. C. Omer, & N. Y. Sharp. (2013). Business strategy, audit fees and financial reporting irregularities. *Contemporary Accounting Research*, 30(2): 780–817.
- Cheng, C.S.A., Huang, H.H., Li, Y., & Stanfield, J., (2012). The effect of hedge fund activism on corporate tax avoidance. *The Accounting Review*, 87(5), 1493–1526.
- Dhamara, G. P., & Violita, E. S. (2018). The Influence Of Financial Distress And Independence Of Board Of Commissioners On Tax Aggressiveness. *Advances in Economics, Business and Management Research*, 55(6), 81-86. <https://doi.org/10.2991/iac-17.2018.15>
- Dunbar, A. E. & J. D. Phillips, (2001). The outsourcing of corporate tax function activities. *Journal of the American Taxation Association*, 23(2): 35-49.
- Ghozali, I. (2006). *Aplikasi Analisis multivariate dengan program SPSS*. (2nd ed.). Yogyakarta, Indonesia: Penerbit Universitas Diponegoro
- Higgins, D., Omer, T. C., & Phillips, J. D. (2015). The Influence of a Firm's Business Strategy on its Tax Aggressiveness. *Contemporary Account Research*, 32(2), 674-702. doi:10.1111/1911-3846.12087
- Higgins, D., Omer, T. C., & Phillips, J. D. (2011). Does a Firm's Business Strategy Influence its Level of Tax Avoidance?. *2011 American Taxation Association Midyear Meeting: JATA Conference*. <http://dx.doi.org/10.2139/ssrn.1761990>
- Martinez, A. L. and Ferreira, B. A. (2019). Business strategy and tax aggressiveness in Brazil. *Journal of Strategy and Management*, 12(4), 522-535. <https://doi.org/10.1108/JSMA-03-2019-0040>
- Maulana., Marwa, T., & Wahyudi, T. (2018). The Effect of Transfer Pricing, Capital Intensity and Financial Distress on Tax Avoidance with Firm Size as Moderating Variables. *Modern Economics*, 11, 122-128. [https://doi.org/10.31521/modecon.V11\(2018\)-20](https://doi.org/10.31521/modecon.V11(2018)-20)
- Miles, R. E., Snow, C. C., Meyer, A. D. & Coleman, H. J. Jr (1978). Organizational Strategy, Structure, and Process. *Academy of Management Review*, 3(3), 546-562. Doi: 10.2307/257544
- Nugroho, S. A., Firmansyah, A. (2017). Pengaruh Financial Distress, Real Earnings Management, dan Corporate Governance terhadap Tax Aggressiveness. *Journal of Business Administration*, 1(2), 17-36. Doi: 10.30871/jaba.v1i2.616
- Putri, R.A.H., Chariri, A. (2017). Pengaruh Financial Distress dan Good Corporate Governance terhadap Praktik Tax Avoidance pada Perusahaan Manufaktur. *Diponegoro Journal of Accounting*, 6(2), 1-11.
- Richardson, G., Lanis, R., Taylor, G. (2014). Financial Distress, Outside Directors and Corporate Tax Aggressiveness Spanning the Global Financial Crisis: An Empirical Analysis. *Journal of Banking & Finance*, 52, 112-129. Doi: <http://dx.doi.org/10.1016/j.jbankfin.2014.11.013>
- Richardson, G., Taylor, G., Lanis R. (2015). The impact of financial distress on corporate tax avoidance spanning the global financial crisis: Evidence from Australia. *Economic Modelling*, 44, 44–53. <https://doi.org/10.1016/j.econmod.2014.09.015>
- Wahyuni, L., Fahada, R., & Atmaja, B. (2017). The Effect of Business Strategy, Leverage, Profitability and Sales Growth on Tax Avoidance. *Indonesian Management and Accounting Research*, 16(2), 67-80. Doi: 10.25105/imar.v16i2.4686



Cafes: New Learning and Knowledge Production Space for Millennial Students

Yohanes Slamet Purwadi¹, Elvy Maria Manurung²

¹School of Cultural Philosophy, Parahyangan Catholic University, Bandung, Indonesia. Email address: yohanes@unpar.ac.id

²School of Management, Parahyangan Catholic University, Bandung, Indonesia. Email address: elvymaria@unpar.ac.id

Correspondence: Elvy Maria Manurung, School of Management, Parahyangan Catholic University, Bandung 40117, Indonesia. Tel: -. E-mail: elvymaria@unpar.ac.id

Abstract

The presence of new cafes and restaurants over the last three years in the city have been emerging. These cafes and restaurants do not only serve food or drink but also provide the facility to hang-out, play and study, which are a new phenomenon. This research aims to discover the reason why so many students fulfill these cafes and restaurants. The research conducted to a hundred and eighty-eight students in Bandung city, West Java. Nowadays, the students as consumers are getting voters to choose a place to study, besides in school or campus. This is a qualitative research which done by several observation and interviews. Seven new cafes and restaurants were chosen as research objects. The criteria specified in selecting consumers as informants is the frequency of attendance on the selected cafes and restaurants at least two times a week. A new culture in learning behavior was found. The findings and interpretation show that millennials students prefer to choose café or restaurants as a place for learning while they're eating. They do not want to study in campus or library due to a tedious atmosphere and stressful around campus according to students' opinions. A new definition of "space" (informal space) as a place for learning is found. The café caters to the imagery of erudite, cosmopolitan, and up-to-date youths, all of which are appealing. As a conceptualized space the humble café has transcended beyond its calling as a pit stop and has been reborn as an expression of academic life, combining knowledge production and mood booster, serious knowledge, and playfulness. The illustrious café, make no mistake is the representative space of choice for millennial (Z generation) scholars. This research and experiment were carried out in certain areas in West Java. similar research is needed in other cities or other countries. Besides, it is necessary to explore further what factors change millennial students learning behavior, whether only because of a more relaxed atmosphere or other factors. Implications: Similar experiments need to be applied to bring students outside the classroom to get a new atmosphere, mood booster and their participation in class, for other courses in college.

Keywords: Cafes, Millennial Students, Learning Behavior, Space, Learning Space

1. Introduction

The influence which "space" bears towards perception, mobility and the practices of human behavior is a given, whether it be psychological --perception, cognition, and the process of motivation-- or on an existential plane that,

in turn, construct responses manifested in a behavior. Numerous studies of college students have revealed a phenomena of mobility, from the typical academic classroom, students have shifted towards another public space: the Café. Underlying this shift is the concept of space and architecture both are intertwined to scientific engineering.

The concept of "space" is meant to be so much more than a "conceived space" or "a scientific space". The rooms within the campus propagate an academic and scientific atmosphere to promote the conception of scholars and scientists. The Campus space is thought more of as a representation of the "knowledge's hegemony", it is however criticized as being too impersonal to the detriment of one's creativity and the stimulation of knowledge. "Space" as a place to study, now has changed away from the formal and an inclination towards informal spaces.

Bandung, which is known as "Paris Van Java", is one of the cities in West Java which has undergone a quite rapid development during the last five years. Bandung is no longer only known as a city that has a lot of students studying or "student city", but will also be known as a tourist or tourism city. Since the construction of Cipularang toll which connects Bandung with Purwakarta regency, Jakarta, and other areas around Bandung, in 2005, the flow of vehicles and local tourists to Bandung increased. Consumer behavior which is increasingly smart and unpredictable is followed by the emergence of hotels, boutiques, distros, restaurants and cafes in Bandung which has increased in recent years. The emergence of cafes and restaurants, not only enjoyed by local tourists, but also by student who studies in Bandung. Nowadays restaurants or cafes in Bandung, are not just places where people eat and drink, but also at the same time a place where many people, especially students are able to hang-out, play, and even study. Society, especially young men in Bandung are now experiencing changes in taste, way of thinking and how to shop due to the presence of boutiques, distros, cafes and new restaurants.

This phenomenon of developing Bandung does not only produce an impact on the economic field but also on the socio-cultural aspects of the user community. A lot of research in Bandung has been done to find the impact of the rise of cafes, boutiques and distros that provide fashion and culinary products to urban economic development, but not many have focused on the creativity of young entrepreneurs and the social and cultural development of the user community. Other research on the presence of cafes, coffee shops, and other "hangout" places in Indonesia has been done in Yogyakarta (Central Java) by Iwan Pribadi (2015), as a form of change of the community lifestyle. The results indicate that the presence of coffee shops in Yogyakarta is no longer dominated by men or fathers only, but also by women. Today's coffeehouse has provided a new "space" for diverse visitors – who come to enjoy the interaction, and also eat and drink. Another similar research was conducted by Pramita, D.A., and Pinasti, V.I.S. (2016) that focus on the habit of "hanging out" of college students in coffee shops in Yogyakarta. The aspects studied in the research, again, emphasize the lifestyle of students in Yogyakarta. Research on the lifestyle of students in the city of Bandung has also been done by Fauzi, A. et.al. (2013) and Wahidah on the objects of places such as pubs or cafes (known as "*dugem*" or "*dunia gemerlap*" in Indonesian language) that open at night and usually just close in the morning in Bandung.

Some research on the change of mindsets and lifestyles of young people in Indonesia as described above, has not focused and completely revealed what has happened and changed with young people in Bandung for the last five years. What kind of creativity should appear and be shown by the entrepreneur to make his business survive, as well as changes in socio-cultural construction as what happens to the people of Bandung in general. The aforementioned matters make this study different from other related studies. This research is directed to answer two big questions as follows: (i) How culinary development during the last five years has affected the creativity of young entrepreneurs in Bandung?, and (ii) What changes have occurred to users/consumers in Bandung? This research aims to answer both questions.

Importance of the Problem

State why the problem deserves new research. For basic research, the statement about importance might involve the need to resolve any inconsistency in the results of past work and/or extend the reach of a theoretical formulation. For applied research, this might involve the need to solve a social problem or treat a psychological disorder. When research is driven by the desire to resolve controversial issues, all sides in the debate should be represented in balanced measure in the introduction. Avoid animosity and ad hominem arguments in presenting

the controversy. Conclude the statement of the problem in the introduction with a brief but formal statement of the purpose of the research that summarizes the material preceding it. For literature reviews as well as theoretical and methodological articles, also clearly state the reasons that the reported content is important and how the article fits into the cumulative understanding of the field.

Historical-pedagogically wise, our founding father of education Ki Hajar Dewantara, he himself preferred to advocate the term "taman" (garden) in lieu of "school". This denotes a pronounced aspect of "playfulness" in learning, as opposed to pedantic. The essential concept of "taman" by definition is a space which accommodates the possibility of exploring: the dialectic process between student and rational knowledge all the while enabling a sense of liberative "play". Most of these requirements have been fulfilled by the public space all the while offering an ambience of merriment, intimate learning, and good old fun. None of which are to be found in the traditionally constrictive environment of the "scientific space" provided by the campus, thus the motive of exodus away from the classroom to hangout places such as cafés. Not only are these locales essentially a space socially produced they further encourage social reproduction: cafés were first introduced to market mood and relaxation. These favorable environmental qualities have led cafés to ultimately be applied for the purpose of knowledge production. This means, college students are using cafés as non-academic spaces to produce knowledge simply by virtue of pleasant atmosphere, "fun".

Therefore, the construction of areas spatially is certain to affect the mobility, simultaneously the mentality of its occupants, mobility away from the academic space to a "liberative" space, mobility shunning the impersonal cubicle to the adoption of the cozy alternative. This all creates what Henri Lefebvre designates as a "social space production" that is to say the production relations between rooms spatially and "fresh" actions. In other words, "social space is formed by social action, be they individual or collective. It is none other than social action which gives "meaning" as to how a spatial room is conceptualized by those occupying and inhabiting aforementioned space. Social space production follows how social practices manifests through the perception of the environment, made through networks which connect social activities like work, private life and leisure.

2. Method

This study was conducted using a qualitative method called ethnography. Ethnographic method begins with the science of anthropology which emphasizes the observation of the social behavior of society in a particular area to gain understanding and interpretation of the empirical phenomenon that occurs. The present use of ethnographic methods has grown broadly and is used in other sciences including business and economics.

As "a portrait of people", according to Haris and Johnson in Gunawan, I. (2015), is the simplest ethnographic deficit. In a broader sense, ethnography means "written description of a particular culture -the customs, belief, and behavior-based on information collected through fieldwork." Therefore, ethnography is an inductive method of research that puts the researcher's sense of reality (emphasizing subjectivity) --a process of deep thinking-- and an interpretation of concepts found by researchers. Not infrequently a researcher will also enter the field and mingle with the object which is studied, be a participant observation.

In this study there are two groups that become the object to be observed, namely:

- (i) a group of young entrepreneurs who run a fashion or culinary business in Bandung
- (ii) Consumers (users) who enjoy products sold by businesses run by young entrepreneurs.

The author enter into the object studied and observes directly as a participant-observer. There are several ways to obtain data, as follow: (i) spreading 150 questionnaires to get key points about what affects user/consumer behavior and decisions, (ii) focus group discussions (FGDs) to confirm the results of data processing from the incoming questionnaires, and (iii) interviewing business owners which are young entrepreneurs in Bandung. Therefore, data analysis in this study is an interpretative meaning obtained, mainly derived from observation and interview.

This research has begun with an internal discussion with a group of consumers who are students at the same university. Based on the results of the discussion, there are seven places selected to observe:

- a. Cafe "DE" in north Bandung
- b. Cafe "UPN" in central Bandung
- c. Cafe "EB" in central Bandung
- d. Coffee Shop "SB" in south Bandung
- e. Coffee Shop "NB" in central Bandung

From 180 questionnaires distributed, 178 respondents obtained and fill in it completely. Questionnaires are prepared in the form of closed and open questions, with the following systematics in Table 3.

Table 3. Systematic of Questionnaire

<i>Introduction</i>	Contains open questions regarding: (i) name, (ii) age, (iii) sex, (iv) employment status, (v) income status
<i>Content</i>	Contains semi-closed questions regarding: (1) What cafes or coffee shops which are frequently visited? (2) How often (frequency) are they visited? (3) Why choose that location? (4) Why do not choose another place or at home? (5) What comes to mind or perception of the existence of the cafe and its visitors? (6) What is the required budget (expenditure) to go to the place? (7) Are you interested in trying another place? (8) What is consumer opinion about culinary development in Bandung?
<i>Conclusion</i>	Acknowledgments and request to the respondents to be re-contacted if any information is unclear (there is stated the phone number or ID Line of the respondents which can be contacted).

3. Results

From total 178 respondents, 66.2 % is female and 33.8% is male. Most of respondents which are 80% are students, the age ranging from 13 until 22. The majority of the students (75%) get the source of income from parents, while the remaining 25% get income from their jobs. They choose to go to their favorite cafes because they need a place to study and eat. The chosen place selection describe in Figure 1. The -UPN, -SB and -EB become the most three cafes want to visit by respondents. Furthermore, 62.4 % quite often visit these three cafes.

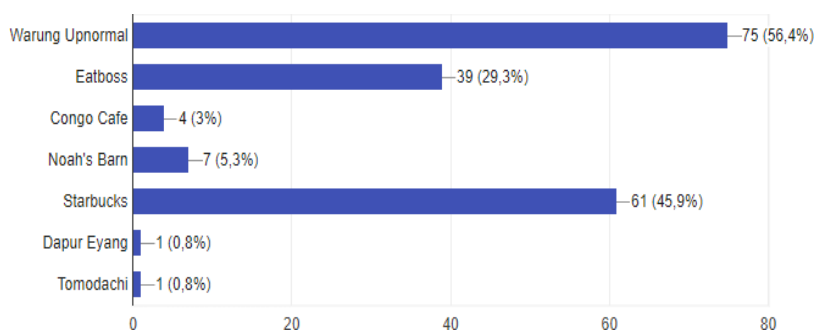

Figure 1. Chosen Café to Hangout

(Source: Manurung, E.T., Manurung, E.M., and Purwadi, Y.S., 2018)

The reasons the respondent choose the place largely because of the comfortable factor. Most respondents are more interested in doing tasks/jobs / learning elsewhere than in the libraries because the atmosphere of libraries tend to be rigid. The respondent said that they do not believe that eating in cafes/restaurants symbolize a particular image (51.1% of respondents). A total of 81 respondents choose culinary aspects from the taste sensation. They said that they want to eat delicious food when using their free time. 88 respondents (66.2%) choose to come to the café to take advantage of the facilities provided. The graphic is shown in Figures 2 and 3.

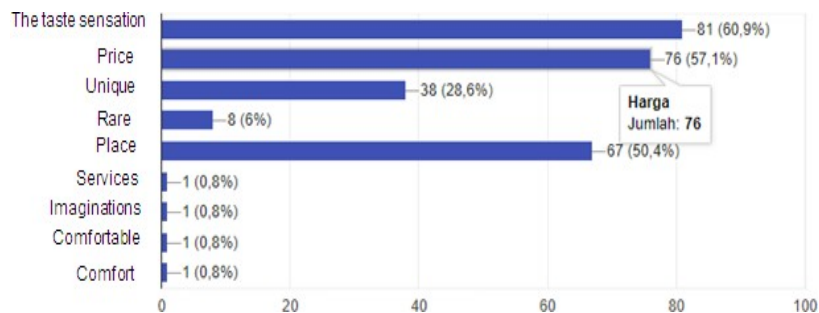

Figure 2. Reasons To Choose Café

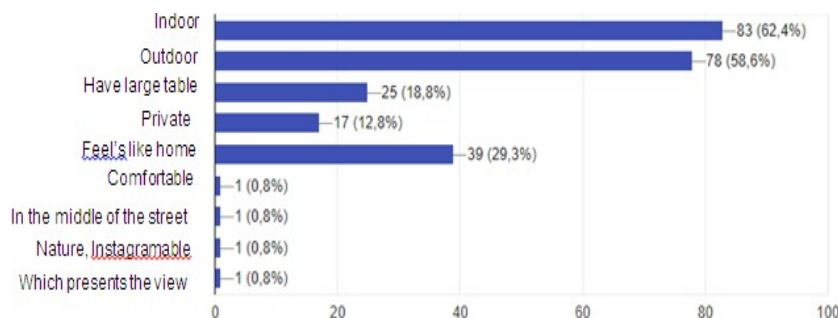

Figure 3. Choosing Café and Learning

Most of them (54.9%) said that they do not set aside money to go to restaurants. They said that their spending budget to eat in cafes is less than IDR 500.000 per month, which number is the most spending (84.2%). From total, 57.1% of the respondents rarely goes to the same culinary places. The reason of such thing, is because they love to experience different taste and atmosphere of other culinary places. Indoor cafe has become the favorite type of cafe of the 133 respondents. While the preferred menu when going to the café or restaurant is the coffee / other drinks menu. According to the respondents, Bandung is very interesting because the taste of culinary in Bandung is various and worth trying. These all opinion shown in Figure 4.

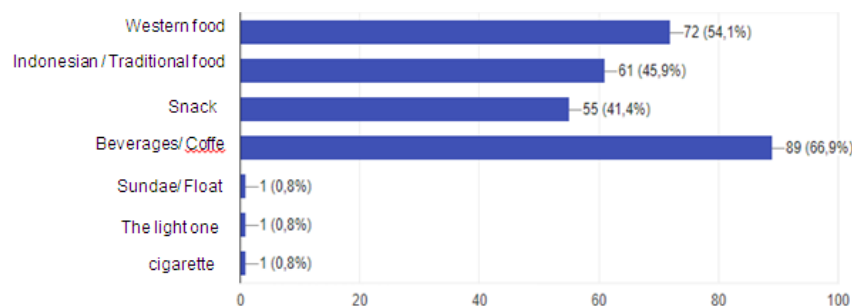

Figure 4. Chosen Majority Menus

(Source: Manurung, E.T., Manurung, E.M., and Purwadi, Y.S., 2018)

From the analysis and discussion, there are some interpretation found that reflect a new socio-cultural behavior constructed by emerging several creative-cafes today:

- (i) users are looking for a comfortable place to learn while eating, a need that has never been emerging in the past
- (ii) the place selected does not always have to be a place that is hype
- (iii) the most wanted café is indoor place
- (iv) most café chosen by its fast *Wi-Fi*, big table and comfort place to do some homework and assignments

4. Discussion

To examine the validity of those findings, an experiment has done to prove the findings by bringing several groups of students out of the classroom, head to the nearest café and study there. A certain course that requires field study consists of five student groups. Consensus in the class determined three of five groups agree to go to a chosen café, meet directly with the owner, and study there. Students are welcome to directly ask the owner about all material related to the course (in this case was financial management) to be asked directly to the owner. They also had the opportunity to see how certain types of coffee were made and served, how to serve customers' orders, and so on. The other 2 groups were not included in this field study because they were unable to join the schedule and they should study the materials on their own. What has been experienced and felt by the other three groups, unfortunately, cannot felt by these two other groups.

The results are quite amazing, for 3 groups who learn directly in the field (café) they look more relax and comfortable to ask and discuss. Two participants who had rarely entered the class so far and his/her attendance were not many comments, or no comments at all suddenly changed. A young man who was always busy with other matters, at that time gave many opinions and become the center of attention of his friends. As well as another female student, she requested that lecturing become more often memorized outside the classroom. Unfortunately, her request was difficult to fulfill due to the financial limitations of the lecturer. Some interviews quotes with the students are as follows:

“Ma'am, I am more relaxed here and able to get my ideas out... it's not like learning in classroom. I've always stressed... It's hard to talk and join the discussion...” (R, October 2018)

“Ma'am, I'm so glad we can go outside the classroom and study here... can we always study outside like this for the next lecture?” (P, October 2018)

Documentation during the experimental learning process is shown in Figure 5-7.



Figure 5. Experimental Learning
—with Practitioners



Figure 6. Experimental Learning
---passive student became active



Figure 7. Experimental Learning
—everybody happy

Different from previous researches that focus on emerging in cafes in Bandung as a shifting of consumers lifestyle, this study proven that cafés offer “space” or “informal space” that match with consumers --especially millennial students needed. The phenomena of –public space studying is linked to the social space produced to interpret--studying which qualitatively is almost identical to that of leisure. And in practice, this may be related to the existential function of Henri Levebvre’s space, that space creates –a desire of self-exhibition. Here students have transformed the café to a versatile stage with a purpose two-fold, equal parts classroom and recreation room, studying all the while reveling in self-exhibition and available social aspect perks. The Café is sumptuous platform where showcases of prestige from one person to another are conveyed via vis-à-vis interaction. More than just a sanctuary from the mundane confines of campus life born by students, café spatial rooms were designed with the concept that you belong to a network of amity: studying together with pals and cordial friendships in mind.

Moreover, owing to their enchanting air which invokes a sensation of ease and jocundity, this serves as a recharging mood booster of sorts for another unintentional function: the production of knowledge. In this case for consumer students the café is a veritable pleasure cruise complete with a pick-me-up to boost creativity.

Conclusion

This phenomena is also connected to representational space referring to space that is lived (*lived space*) as well as all forms of imagery and symbols pertaining. Representational space includes how occupants interact, practices and visualization forms within the space. The concept of space is created based upon the collection of actual experiences everyone undergoes as a cause and effect principle of a dialectic between spatial practices and space representation. Space becomes whatever is perceived by an individual, group or society: perceived space. This all explains just why students favor café's as space, these spaces vivify mood and study habits gilding the lily is the fact that these purported eateries also support audio-visual devices be they laptop, cellphones, or tablets. In such social space, students are absorbed to –dense fabric of networks and channels that contextualize production of knowledge. The café caters the imagery of erudite, cosmopolitan, and up-to-date youths, all of which are appealing. As a conceptualized space the humble café has transcended beyond its calling as a pit stop and has been reborn as an expression of academic life, combining knowledge production and mood booster, serious knowledge and playfulness. The illustrious café, make no mistake is the representative space of choice for millennial (Z generation) scholars.

Acknowledgments

This research was supported by the Research and Community Service Institution of Parahyangan Catholic University. Thanks to 178 millennial students that willing to be interviewed and fill the questionnaires.

References

- Fauzi, A., Punia, I.N., Kamajaya, G. (2015). Young People Hanging Out in The Café: Review of Young People Life-Style in Bali. Faculty of Social and Political Science Research Paper, Udayana University, Bali.
- Gunawan, I. (2015), *Etnography Research Method*. Pedagogy Science Faculty. Malang Public University.
- Henry, D. (2018). *Marxist & Social Constructivist Approaches to Place*. Retrieved from <http://pegasus.cc.ucf.edu/~janzb/courses/hum3930b/lefebvre1.html> Taken on October 16, 2018.
- Hidiaz, T. (2014). Interaction of Behavior in Limited Space Environment: Case Study of Capsule Hotel The Pod, Singapore. Rekarupa, FSRD Jurnal Itenas, No. 2, Vol. 2, ISSN No. 2088-5121.
- Huzari, R. (2015). Return The School Concept as A Playground (*Kembalikan Konsep Sekolah Sebagai Taman*). Retrieved from, <http://www.babelprov.go.id/content/kembalikan-konsep-sekolah-sebagai-taman>. Taken on October 22, 2018.
- Lefebvre, H. (1991). *The Production of Space*. Cambridge: Blackwell.
- Lefebvre, H. (2008). *Critique of Everyday Life: Foundations for A Sociology of the Everyday*. Vol. 2. London and New York: Verso.
- Manurung, E.T., Manurung, E.M., and Purwadi, Y. S. (2018), Young Entrepreneur Creativity and Socio-Cultural Construction of Fashion and Culinary Businesses in Bandung: A Multidisciplinary Research Report. Research Institution and Community Service of Parahyangan Catholic University (UNPAR), Bandung, Indonesia.
- Pamungkas, A. S. (2016). The Production of Scape and Urban Revolution according to Henri Lefebvre. Retrieved from <https://indoprogess.com/2016/01/produksi-ruang-dan-revolusi-kaum-urban-menurut-henri-lefebvre/> Taken on October 11, 2018.
- Pramita, D.A., and Primasti, I.S. (2016). Hang out at the Coffee Shop as a Student Lifestyle in Coffee Mato Yogyakarta (*Nongkrong di Warung Kopi Sebagai Gaya Hidup Mahasiswa Di Mato Kopi Yogyakarta*). Journal of Sociology, University of Muhammadiyah Makassar.
- Pribadi, I. (2015). Hang Out at A Cafe Or Coffee Shop as Young People Lifestyle (*Gaya Hidup Anak Muda Nongkrong Di Kafe Atau Kedai Kopi*). Thesis and Dissertation Repository, Gajah Mada University, Yogyakarta.
- Wahidah, N. (2013). Consumptive Behavior Effect on Student Lifestyle (*Pengaruh Perilaku Konsumtif Terhadap Gaya Hidup Mahasiswa*) Economics Faculty of FKIP UNTAN. Research Article at Tanjungpura University, Pontianak, Indonesia.



An Assessment on the Influence of Entrepreneurial Training, Risk-Taking and Innovativeness on SMEs Development in Nigeria

Dele Olaolu¹, Nkem Okpa Obaji²

¹Faculty of Management and Social Sciences, Baze University, Abuja, Nigeria

²Faculty of Management Sciences, National Open University of Nigeria, Abuja, Nigeria

Correspondence: Nkem Okpa Obaji, Faculty of Management Sciences, National Open University of Nigeria, Abuja, Nigeria, Tel: +2348169119771 -. E-mail: amazonsng@yahoo.com

Abstract

Small and Medium Enterprises (SMEs) are key to local economic development, occupying a worth mentioning function in job creation, poverty alleviation and economic growth, but they run into numerous entrepreneurial hurdles. The aim of this study was to assess the influence of entrepreneurial training, risk-taking and innovativeness on SMEs development in Nigeria, with specific reference to Abuja Federal Capital Territory. The study employed a quantitative approach. All items of the questionnaire were measured using a 5 point Likert scale. Data were collected from SME owners operating within Abuja Federal Capital Territory. A sample size of 339 was drawn from a population of 2825 SME operators. However, a response rate of 43 percent valid questionnaires was retrieved from the respondents. This research supported the positive effects of entrepreneurial training and innovativeness on SME development. In terms of contribution, entrepreneurial training contributed 49.1 percent while innovativeness contributed 20.1 percent to the model. In addition, risk-taking has an insignificant small negative relationship with SME development in the study context. The study, therefore, recommends that entrepreneurial training should be taken seriously by SMEs operators as the business world experience is much more than an academic exercise. Similarly, SMEs should find a way to innovate if they must survive the harsh and competitive business environment. Finally, the study recommends that the business owner should avoid uncalculated risk, as not all risks are worth taking. The experiential results are pertinent to policymakers in order to arouse, buoy up and provide support for SMEs' development through their policies.

Keywords: Entrepreneurial Training, Innovativeness, Nigeria, Risk-Taking, SME Development

1. Introduction

Entrepreneurship exposition has progressively mentioned the critical prominence of small and medium enterprises (SMEs) to economic growth (e.g. Azudin & Mansor, 2017; Opute, 2019 – (in press)). In the context of a developing country, the literature highlights the significance of entrepreneurship and SMEs to be specific to contend with unemployment and poverty and driving economic growth for example in India (e.g. Benhard, 2013) as cited in Iwu and Opute (2019), and in Nigeria (e.g. SMEDAN, 2017).

SMEs are a worth mentioning driver of economic development (Obi, Ibidunni, Tolulope, Olokundun, Amaihian, Borishade, & Fred, 2018)), being essential to the majority of the nations globally, particularly in evolving and emergent countries (Ndiaye, Razak, Nagayev, & Ng 2018). Distinct from big businesses, SMEs are extremely flexible, revealing a superior flexibility to technical shifts, higher promotion of income distribution and better adaptability to fluctuations in the market and new customer requirements, while their organisational structure permits for faster decision making (Perez-Gomez, Arbelo-Perez, & Arbelo, 2018). However, to achieve this potential, SMEs need a constant source of long-term funding so as to invest in growth opportunities (Dowling, O'Gorman, Puncheva, & Vanwalleghem, 2019).

SMEs are viewed as the backbone of any economy (Yoshino & Taghizadeh-Hesary 2019) as they put forth an important function in reducing poverty, employment creation, foreign trade promotion and technique innovation (Luo, Wang, & Yang, 2016), as well as contributing importantly to the growth of developing economies (Winfred, 2006).

In today's world and business environment; training, innovativeness and the ability of the business owner to take well-calculated risks has the hallmark of a successful business venture. This is because training and innovation are seen as factors or indices that determine how a business performs.

The ability of the Small and Medium businesses to create and distribute wealth; thereby improving the national economy of a nation stems from their abilities to take a calculated risk. Small and medium-sized enterprises (SMEs) play vital roles in today's economy and contribute immensely to output, income and employment.

SMEs according to Henderson (2002) as cited by Fassin (2008) and Perrini (2006) serve a link between the community and the global economy and act a tool for national economic development. They also serve as the source of innovation and wealth/job creation according to Musawa and Wahab (2012).

Oyelaran-Oyeyinka, Adelaja, and Abiola, (2007) opined that Nigeria being an emerging economy; SMEs have great potentials to influence the Gross Domestic Product (GDP) of the nation in the near future if well managed. Also, study by Nwankwo, Akunuri, and Madichie, (2010) are of the view that SMEs provide over 50% of Nigeria's employment, thereby, making SMEs an important and indispensable sector of the Nigerian economy.

1.1 Problem Statement

Most SMEs operators and managers in Nigeria do not have the requisite entrepreneurial training, risk-taking abilities and are not innovative which are requirements for business competitiveness. As a result, most SMEs are not able to develop and perform better. Because most SMEs are not innovative and not able to take the risk due to lack of training, little is documented of SMEs innovations in Nigeria. So, this study aims to unravel the influence of training, innovation and risk-taking ability on SMEs development in Abuja, Nigeria.

Entrepreneurial training, risk-taking, and innovativeness are complicated issues vis-a-vis SME development. For the reason of their size, and financial capacity SMEs often have less skills; while their risk-taking and innovative abilities are also limited, thus making them unable to contend with big organizations. Couple with the dissenting views of researchers on the influence of these variables on SMEs development, this research attempts to study the influence of these variables (entrepreneurial training, risk-taking and innovativeness) on SMEs development in Nigeria.

1.2 Objective of the Study

The study was guided by the objectives below;

- To examine the influence of entrepreneurial training on SMEs development in Abuja, Nigeria.
- To assess the influence of risk-taking on SMEs development in Abuja.
- To examine the influence of innovativeness on SMEs development in Abuja

1.3 Research Hypotheses

The study tested the following hypothesis

H₁: Entrepreneurial training, has significance influence on small and medium-sized enterprise development and performance in Abuja.

H₂: Risk-taking has significance influence on small and medium-sized enterprise development and performance in Abuja.

H₃: Innovativeness has significance influence on small and medium-sized enterprise development and performance in Abuja.

2. Literature Review

2.1 Concept of SMEs Development

Small and medium-sized enterprises (SMEs) are viewed widely as the bedrock of economic development according to Robson, Haugh and Obeng (2009). Because of the role SMEs play in national economic development of any nation, countries have been searching for ways to stimulate their economic growth through more and better SMEs development (Oly Ndubisi & Iftikhar (2012).

Small and medium-sized enterprises were considered to be the driving force in economic development because of their contribution to job creation and technological innovations (Kumar and Subrahmanya 2010). While according to Mbugua, Mbugua, Wangoi, Ogada and Kariuki (2013) and Kirby and Kaiser (2003), a nation's economy depends largely on the number of SMEs operators. In their views, a large number are employed in the SMEs sector than in public sector.

Also, according to Ebiringa (2011), SMEs perform a major function in economic development of several countries in the world. He, therefore, said that SMEs contribute immensely to the achievement of general economic development, which most times lead to GDP growth, improvement in the standard of living and generate employment; thereby reducing unemployment (Abdul, 2018; Syed, Ahmadani, Shaikh & Shaikh 2012).

SMEs were seen as the connecting link between the community and the larger global economy (Oke, Burke & Myers 2007; Thurik, 2009; Carree & Thurik, 2005). They also serve as a source of job creation, technological growth, and innovation (Kusumawardhani, McCarthy & Perera, 2009). According to Aigboduwa and Oisamoje (2013) and Oyelaran-Oyeyinka and McCormick, (2007), in Nigeria SMEs have great growth potentials and will contribute a very significant part of the country's GDP in time to come. While Owusu-Frimpong and Nwankwo (2012) opined that 50% of Nigeria's employment is provided by SMEs and SMEs also contribute 50% of the nation's industrial output. SMEs serve as a path to attaining national economic objectives such as poverty reduction. They enhance indigenous technologies, thereby improving entrepreneurial capabilities.

According to Oyelaran-Oyeyinka, Adelaja and Abiola (2007); Kadiri (2012); and Asenge, Diaka and Soom (2018), SMEs stimulate economic activities, enhance standard of living, lead to increase in technological advancement, creation of new products and service and lead to new and or improved ideas and ways of doing things. According to these researchers, SMEs are the building block and cornerstone for economic growth and social development, it improves the lives of rural dwellers and leads to an increase in revenue generation. For instance, 99% of the factory workers in Japan are employed in the SMEs sector, while 74% of the Korean workforce is employed in the SMEs sector. These two nations are very industrialized, this implies that the majority of technologies that emanate from these countries come from the SMEs sector of their economy. In the United State of America, 87% of the workforce is employed in the SMEs sector; while the SMEs sector in Germany employs 72% of the country's workforce. In view of these, we see that SMEs have the prospect of employing more labour and increasing production, if properly harnessed; thereby increasing the nation's GDP and reducing unemployment.

2.2 Concept of Entrepreneurial Training

Different writers have defined training in different ways (e.g. Dipboye, 2018; Bell, Tannenbaum, Ford, Noe & Kraiger 2017). While some definitions lay emphasis on current knowledge, skill and ability needs; others concentrating on impending needs. Training, however, can be defined as consisting of both 'training and development' with training concentrated on knowledge, skills and abilities (KSAs) required for the current job role and development aiming at KSAs required for a future role (Garavan, 1995; Kraiger, Passmore, dos Santos & Malvezzi, 2014). Therefore the future component is conceptualized as development.

The importance of training has been emphasised by numerous researchers. Cases in point are (Aguinis & Kraiger, 2009; Kim & Ployhart, 2014; Noe, Clark & Klein 2014) who contended that training improves organisational performance comprising productivity, innovation, customer service quality and financial performance.

There have been reported cases of high failure rates of SMEs, as many of the small and medium-sized businesses do not survive the first 3 years of operation, hence dying at infant. One of the reasons that have been alluded to this death of SMEs has been lack of or inadequate entrepreneurial training (Bowen, Morara & Mureithi 2009).

According to Nduta, (2016) a key ingredient to SMEs growth and development is entrepreneurial training. She opined that the outcomes of entrepreneurial training in SMEs development include a better and a more robust business management technique, adoption of new technologies and business linkages. Entrepreneurial training is said to be on the increase around the world according to Kirby (2004).

According to Lindh and Thorgren (2016), entrepreneurial training opens the door to opportunity recognition, improves the creative abilities of the entrepreneur, increases business growth and making him/her think critically. While Long and Chrisman (2014), saw entrepreneurial training as a way of increasing entrepreneurial skills such as creativity, determination, decision making, resourcefulness, cognitive reasoning and leadership abilities. Namusonge (2006), argued that entrepreneurial training stimulates entrepreneurship and business growth. He is of the view that SMEs that adopt entrepreneurial training has 9% more survival rate than those without training programs.

2.2.1 Apprenticeship as a type of entrepreneurial training

Apprenticeship is a method in which trainees learn a trade or craft through hands-on experience while working with a skilled worker in that profession. It is further defined as an arrangement in which someone learns a job, an art or a trade under another person who is experienced in the chosen field (Mohrenweiser & Backes-Gellner 2010; Ogundele, Akingbade & Akinlabi 2012). While an apprentice is that person who has embarked on the process of learning from an experienced worker (Sterelny 2012).

Gambin and Hogarth (2016), argued that apprenticeship is a cost-effective and efficient method through which workers are impacted with the right and exact skills needed for them of their duties and for a particular line business. Before now, there has a general misconception that apprenticeship is needed only in the manufacturing sector; but in the true sense of it, it is needed in every field of human endeavor. For instance, in today's world, a young accountant would have to undergo training under an experienced accountant. The same is applicable to those in the medical profession. But unfortunately, according to Bilau, Ajagbe, Kigbu, and Sholanke, (2015) and Ogundele, et al. (2012), even with its numerous benefits, apprenticeship is not considered as a path to career by schools.

Apprenticeship inculcates entrepreneurial skills and knowledge which is a key requirement for SMEs development and facilitates easy entry into self-employment. According to Mungai (2012), apprenticeship equips and provides the entrepreneur and or artisan with on-the-job training, thus giving him/her the required skill for the job at hand. He also argued that the training duration is dependent on the nature of business or trade the apprentice intends to embark on. Mungai (2012) further opined that apprenticeship training bridges the skill gap in the SMEs sector.

2.3 *Concept of Innovativeness*

Gherghina, Botezatu, Hosszu and Simionescu (2020) describe innovation to epitomise the process of assigning a certain product on the market (goods or services), a new one or a significantly enhanced one. Innovation centres on the collaboration between research and industry, due to the need for concluding the research through hands-on results associated with the technical and technological developments (Gherghina, Botezatu, Hosszu & Simionescu 2020).

Innovation is defined as coming up with ideas or ways of doing things, therefore everyone can actually innovate. Hence, when innovation is brought into a business, it saves time and money and give competitive edge to such business in the marketplace (Sosna, Trevinyo-Rodríguez & Velamuri 2010). It has also been defined as changing or creating more effective processes, ideas and or products (Trimi & Berbegal-Mirabent 2012). When applied to SMEs, it could refer to implementing new ideas, improving existing processes, businesses or products (Havlíček, Thalassinou & Berezkinova 2013); it is also viewed as a catalyst to business growth and successes.

Rosenbusch, Brinckmann and Bausch (2011) posit that people often mistake invention to innovation. In his view, while innovation deals with changing business model and adapting to deliver better and superior products and services, invention refers to creation of a new their thing or novelty entirely. He ended up my saying that innovation must be an integral part of a business to wants to succeed in today's business environment.

Innovation increases the likelihood of a business to succeed. Businesses that innovate create an efficient and better processes to work, better performance and much more productive than those that do not innovate (Trimi & Berbegal-Mirabent 2012; Sosna et al. 2010).

The process of making something new or doing something in new way was viewed as being innovative by Rhee, Park and Lee (2010). To them it is just about making something new or differently, but making something better which leads to business improvement. It is said to involve developing or improving existing processes, technologies and designs; to increase efficiency, solve problems and increase profit. The following were mentioned as procedures that could lead to businesses innovativeness; conducting market trend analysis, consultation with customers and employees to improve ideas and processes, seek advice from experts, open-mindedness to new ideas, strategy development, responsive plan, training and finally exploitation of new ideas (Rhee, et al 2010; Trimi & Berbegal-Mirabent 2012).

According to Wiengarten, Fynes, Cheng and Chavez (2013), importance of innovativeness to businesses include improve productivity, cost reduction, competitive edge, brand value, improve relationships and partnerships, and improve profitability. While the dangers of a business not being innovative include market loss, low productivity, loss of key staff, reduced profit margin and ultimately business failure (going out of business).

2.4 *Concept of Risk-Taking*

Risk-taking is central to all current societal issues (Rasborg 2012). There have been several contradictions about the dynamics and complexities of risk taking.

Today's world is characterized by risks; risk is seen as being part of everyday normal life (Rasborg, 2012). In today's world, risk-taking is seen to be central to understanding people's perceptions and changes in the environment. According to Zinn (2016), the present-day risk-taking concept consists of two notions: prevention or minimization of risk and the notion that some advantages are only achievable through risk-taking.

Risk-taking foresees sometime a possible negative outcome. By implication, not only positive outcomes but negative outcomes also must be considered by the decision-maker when taking a risk.

According to Lyng (2014) and Lupton (2006), risk-taking can be classified into voluntary and non-voluntary risks. Voluntary risks are risks taken deliberately by an individual with the full knowledge (consciousness) that the

venture or enterprise being embarked upon is risky. It also called risk-taking by choice. Such risk-taking has some degree of control and the person who embarks on such risk is a decision making, thus deciding when to proceed and when to call it to quit. Conversely, Zinn (2015) viewed the argument of voluntary notion as questionable; saying that risk-taking is often shaped by societal conditions.

Risk-taking on its own is backed by different intent and motives. Sometimes it might be aiming for a material gain, developing an identity for oneself or in pursuit of a new idea. Hayenhjelm (2006), suggested that people take risks sometimes due to unfavourable and unbearable situations such as material, physical and emotional. He further said that some risks are taken under pressure where the decision-maker does not have the resources or willpower to resist that situation. According to him in faced with condition, risk-taking is no longer voluntary as it becomes desperate response to existential suffering. An example may suffice, such migrants and refugees who pay smugglers to embark on a high-risk journey.

Risk-taking is major attribute of entrepreneurship, thus a major part of small and medium-sized businesses. According to Keh, Nguyen and Ng (2007), "the higher the risk-taking orientation, the higher business profitability and growth".

Another way of referring risk-taking in SMEs is the uncertainties that result from entrepreneurial behaviour (Tajeddini, 2014). It involves in embarking on calculated and manageable risks aimed at obtaining benefits (Dess & Lumpkin 2005; Morris, Kuratko, and Covin 2010). It also refers to SMEs willingness to commit large resources to opportunities which has reasonable chance of failure and also a willingness to deviate from established norm and tried path delving into the unknown (Naldi, Nordqvist, Sjöberg & Wiklund 2007; Okpara 2009).

2.5 Theoretical Framework

The purpose of any theory is to provide the framework for the understanding, analysis and prediction of behaviours. Theoretical frameworks therefore give meaning to the observations of the researcher. From theory comes hypotheses, which on testing affords the researcher the opportunity to explain current phenomenon and behaviours and predict likely future occurrences and behaviours. Theory is a research paradigm which does not only include assumptions and hypotheses, but includes the appropriate analysis tools, and defines the research questions (Teschendoeff, Sollich & Kuehn 2014).

The theoretical framework for this study is found in the work of Vroom (1964) as referenced by Hyland (1988). The theory dealt with interaction between people's motivation and the work they perform, such as the factors that influence their work performance. According to Hyland (1988), performance has to do with multiplicative function of an individual's motivation and abilities. With this theory, Pretorius, Nieman and Van Vuuren (2005), developed a model.

In the model, Van Vuuren and Nieman (1999) assert that SMEs performance depends on entrepreneurial training and innovation which according to them was called creativity and risk-taking abilities of the managers of the business. In their view, this model should guide curriculum development for entrepreneurship training. It is upon this model that this study is based.

2.6 Hypotheses Development

2.6.1 Entrepreneurial Training and SMEs Development

Several studies found positive relationship between entrepreneurial training and SMEs performance such as Chowdhury, Alam and Arif (2013); Arisi-Nwugballa, Elom and Onyeizugbe (2016). However, Hughes, Hughes and Morgan (2007), have questioned this assertion. This has brought about lack of consensus on the impact of entrepreneurial training on SMEs performance among researchers.

Entrepreneurial training aids the SMEs operator, manager or owner to devise means of survival in today's business environment. It also introduces the SMEs operator/manager to the challenges that the business environment poses and the evolving methods of surmounting those challenges (Zainol, Daud, Shamsu, Abubakar & Halim 2018).

A study in Malaysia on the impact of entrepreneurial training on SMEs development also found a positive relation (Munene 2013). The study suggested that most SMEs operators still require more training in the areas of innovation, business accounting and selling skills. They concluded that entrepreneurial training increases knowledge, experience and skills required for better SMEs performance.

According to a study carried out by Bowen et al. (2009) in Nairobi, Kenya, 45% of those who received one form of entrepreneurial training or another reported a much better business growth.

Entrepreneurial training has been adjudged to be of great importance to SMEs growth. Hassan and Mugambi (2013), argued that training significantly impacted participants' final outcome. It also helps SMEs operators plan and manage modern day business challenges (Kessy & Temu 2010). In studying the effect of training on microfinance institution and their clients, Karlan and Valdivia (2011), found a positive improved business process on both microfinance institutions and their SMEs clients that have undergone training. Based on the above discussions, this study hypothesized that:

H1: Entrepreneurial Training has a significant influence on SMEs Development in Abuja, Nigeria.

2.6.2 Risk-taking and SMEs Development

Kim and Vonortas (2014), studied the influence of risk-taking on Korean firms and discovered a positive association between the both. Xu (2015) was consistent with this view, when said that risk-taking statistically and economically has a positive on firms' growth and performance. And concluded that risk-taking is positively related to corporate growth and performance especially during credit crisis.

Using large panel data from manufacturing firms in Japan from 2002 – 2012, Zhu, Yuan and Zhang (2018), studied the effects of risk-taking on small and medium-sized business. They equally discovered a positive interaction between risk-taking and SMEs growth. They further argued that an enterprise is less likely to exit business decline if such firm does not take a timely and calculated risk.

Theoretical discussions on the influence of risk-taking on SMEs performance suggested positive correlation between the two variables. The abilities and willingness of SMEs to engage in high risk-taking behaviours enable SMEs operators to seize profitable opportunities even in the face of uncertainties (Smit & Watkins 2012).

According to Arshad, Rasli, Arshad and Zain (2014); Zhu et al. (2018)); Ahimbisibwe and Abaho, (2013) risk-taking empirically enables firms to hold off superior growth and long-term profitability when compared to firms that avoid risk. This study, therefore, formulates the following hypothesis:

H2: Risk-taking has significant influence on SMEs Development in Abuja, Nigeria.

2.6.3 Innovativeness and SMEs Development

A study on the effect of innovation on SMEs performance conducted by Ukpabio, and Siyanbola, (2017), in Gwagwalada, Abuja, Nigeria with data from 348 SMEs operators over a 5-year period (2010 – 2015) revealed that innovation had a positive effect on SMEs performance in the Gwagwalada area. The analysis of the data derived was done using the ordinary least square (OLS) method of regression technique. But the study further revealed that, though innovation was a major determinant factor to SMEs performance, most SMEs in Gwagwalada were not innovative.

The findings of Terziovski (2010), which investigated the influence of innovation on SMEs performance on the wooden furniture manufacturing sector of the Indonesian economy was consistent with the observations of Zwingina, Opusunji and Akyuz (2017); as it also affirms a positive correlation these two variables.

According to Gnyawali and Park (2009), entrepreneurial training, risk-taking and innovativeness exert a positive influence on performance among SMEs especially those involved in e-business activities. This study was conducted using 339 small and medium-sized businesses (SMEs) drawn from Spain, Norway and Finland. They argued these variables (training, innovativeness and risk-taking) explain the variations in e-business competencies and performances.

In attempting to discover the mediating effect of innovation on the growth of SMEs, Rhee, Park and Lee (2010) sent 700 questionnaires to small and medium-sized businesses in Taiwan. On the analysis of the responses from the returned questionnaires, they discovered that innovation significantly had a positive effect on the growth of SMEs in Taiwan.

Demirbas, Hussain and Matlay (2011), also investigated the influence of innovation on the Turkish automotive supply industry. The research involved 117 respondents which cut across R&D department, marketing department and production department. The research found that SMEs development and innovativeness are positively related. The study thus hypothesized the following hypothesis:

H3: Innovativeness has significant influence on SMEs Development in Abuja, Nigeria.

3. Research Methods

3.1 Research Design

The term research design deals with the method adopted for collection, measurement and analysis of data. This outlines procedures the researcher intends to take from hypotheses to the final analysis of data; the design adopted for this research is descriptive study. The reason behind the choice of descriptive research is because it seeks to provide accurate description of observations of phenomena (Cooper & Schindler 2014; Hakim, 2012).

The focus of this study is on the influence of entrepreneurial training, risk-taking and innovativeness on small and medium-sized enterprises (SMEs) development, with particular reference to Abuja, Nigeria. The research adopted a quantitative approach, this is because quantitative method of research measures and uses numerical data to explain observed phenomenon (Saunders, Lewis & Thornhill 2009 p.151).

Quantitative approach often makes use of questionnaire for the purpose data collection. There was also issue of localization

3.2 Research Population

Mugenda and Mugenda (2003) assert that research population is the population to which the researcher intends to generalize the study's results. Similarly, population in research refers to the group of people who are meant to be subject to a piece of research (Denscombe, 2014; Ritchie, Lewis, Nicholls & Ormston 2013). The target population in this study are the owners, managers, operators and employees of some registered small and medium sized enterprises in Abuja, with particular reference to those in Abuja Municipal Area Council (AMAC). This is because the research intends to measure the influence of risk-taking, innovativeness and entrepreneurial training on growth and development of SMEs; and majority of the registered SMEs are located in this Area Council. The research population, therefore, is 2825 SME owners operating within Abuja FCT.

3.3 Sample Size

Denscombe (2014) stated how sample size allows the researcher reduces the total quantity data by focusing on a subset of the population rather than the entire population. In the course of this research, SMEs were randomly selected from diverse types and sectors of business in Abuja Municipal Area Council, Abuja, Nigeria.

With the difficulty of obtaining accurate data on the population of SMEs in the Area Council, therefore the sample size was calculated using the Raosoft sample size calculator (www.raosoft.com). A sample size of 339 was drawn from a population of 2825.

3.4 Measurement Model

As a quantitative research, the study embraces numerical manipulation and representation of observations with actual aim of explaining and or describing the characteristics of the manifested observations. The 5-point Likert scale used were represented by numeral figures where 1 = strongly disagree, 2 = disagree, 3 = neutral, 4 = agree and 5 = strongly agree. The items measuring risk-taking followed the approach adopted by Wabungu, Gichira, Wanjau, & Mungatu, (2015) as used by Lawal, Adegbuyi, Iyiola, Ayoade and Taiwo (2018), though with some modifications. SMEs development and performance were a modification of the SMEs performance approach adopted by Khan and Khalique (2014).

3.5 Model Specification

Regression model was used in the analysis of the data derived from the questionnaire. The regression equation had three explanatory variables and one dependent variable. In order to regress the explanatories against the dependent, a model had to be followed. Below is the assumed model

$$\text{SMEs_Dev} = \beta_0 + \beta_1T + \beta_2R + \beta_3I + \epsilon_i$$

Where:

SMEs_Dev = SMEs Development and Performance

T = Entrepreneurial training

R = Risk-taking

I = Innovativeness

β_1 = Coefficient of Entrepreneurial training

β_2 = Coefficient of Risk-taking

β_3 = Coefficient of Innovativeness

ϵ_i = Error term

4. Data Presentation, Analysis and Discussion of Findings

This section focuses on presentation and analysis of data collected through surveying (questionnaires) various stakeholders on their views on the influence of training, innovation and risk-taking on small and medium business performance. The ordinary least square (OLS) regression method was adopted for the analyses, this is done using SPSS statistical software. Both the demographic and regression analyses were done in this section to help us unravel the spread and the influence of the explanatory variables on the dependent variable. The section ended with the interpretation of the findings in relation to the research questions and the hypotheses formulated.

4.1 Questionnaire Return Rate

A total of three hundred and thirty-nine (339) questionnaires were administered and one hundred and forty-seven were returned duly completed, representing 43% response rate.

Table 4.1: Questionnaire Return Rate

Response Rate	Frequency	Percentage
Response	147	43
Non-Response	192	57
Total	339	100

Sekaran (2003) recommends a 30 percent response rate as appropriate for a survey research. Accordingly, the response rate in this study was appropriate representation of the target population that can be reliable for data analysis.

4.2 Interpretations

Having ascertained the validity and reliability of the data; we needed to also verify its suitability for regression analysis. On this wise, some linear regression assumptions were tested. Figure 4.1 showed the normality test output. This result indicated that majority of the points fall within the accepted region of the normal probability plot, thus, showing that the data were normally distributed.

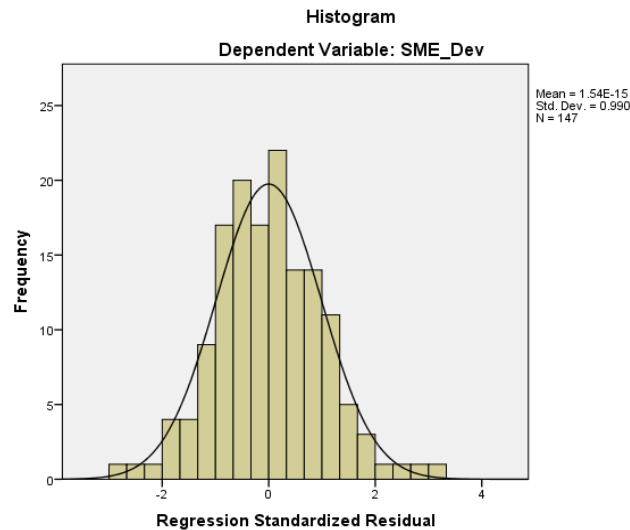

Figure 4.1: Normality Histogram

Furthermore, Figure 4.2, showed the linearity graph; it is observed from the chart that data points were clustered along the regression line (line of best fit) with no outlier; hence, the linearity condition is satisfied. Lastly, on checking for the assumption of no multicollinearity; we discovered from the Durbin-Watson (Table 4.3) value of 2.266, which is an indication of no multicollinearity. Having tested and satisfied the assumptions for linear regression, we then proceeded to test the influence of the independent variables on the dependent.

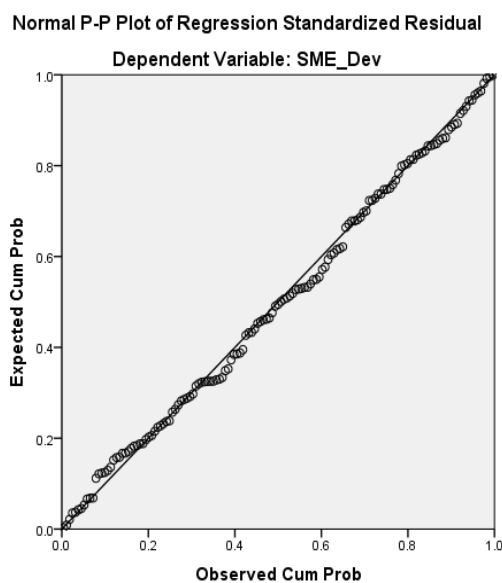

Figure 4.2: Linearity P-P Plot

In the bid to arrive at our research objectives, the data were analyzed as shown by the outputs.

Table 4.2 showed the reliability statistics. This analysis tested for the reliability and validity of the research data (research instrument). The Cronbach's alpha indicated a value of 0.710, this implies that the data are reliable and valid for the research as it shows 71.0 percent reliable. Reliabilities less than 0.6 are considered to be poor, those in the range of 0.7 are considered acceptable while those within 0.8 and above are considered good (Cronbach 1951; Sekaran and Bougie 2010).

Table 4.2: Reliability Statistics

Cronbach's Alpha	N of Items
.710	4

Table 4.3 showed that .558 of the variability of SME development and performance (dependent variable) is explained by entrepreneurial training, innovativeness and risk-taking (independent variables). This discovery suggests that 55.8% of small and medium businesses performing well are those that have been in some of training, innovation and able to take risks.

Table 4.3: Model Summary^b

Model	R	R Square	Adjusted Square	R	Std. Error of the Estimate	Durbin Watson
1	.747 ^a	.558	.548	2.297	2.266	

a. Predictors: (Constant), Innovativeness, Risk_Taking, Ent_Training

b. Dependent Variable: SME_Dev

On testing for the significance of the influence of independent variables on the dependent variable; the ANOVA (Table 4.4) showed that $p < 0.05$. This suggests that at any rate, one of the three independent variables (training, risk-taking and innovativeness) statistically affect SMEs development and performance with a p-value of 0.000.

Table 4.4: ANOVA^a

Model		Sum of Squares	df	Mean Square	F	Sig.
1	Regression	951.019	3	317.006	60.101	.000 ^b
	Residual	754.260	143	5.275		
	Total	1705.279	146			

a. Dependent Variable: SME_Dev

b. Predictors: (Constant), Innovativeness, Risk_Taking, Ent_Training

On revealing that entrepreneurial training and innovativeness (independent variables) were indeed significant in influencing SMEs development and performance, we then ascertained the actual contribution of each of these variables to SMEs development and performance based on the responses of the respondents. This further led to the discovery that most of the risks taking by majority of the respondents have negative effects on their business, which resulted in a negative coefficient for risk-taking. In terms of individual contribution, it was established that Ent_Training contributed .491 or 49.1 percent to SME_Dev, while Innovativeness contributed .201 or 20.1 percent to SME_Dev. These actual contributions led to the construction of the actual model, derived from the assumed model. The model is presented thus;

$$\text{SMEs_Dev} = \beta_0 + \beta_1T + \beta_2R + \beta_3I + \epsilon$$

$$\text{SMEs_Dev} = 8.497 + .491\text{Ent_Training} + .201\text{Innovativeness}$$

This above model explains that entrepreneurial training, and innovativeness influence SME development.

Table 4.5: Coefficients^a

Model		Unstandardized Coefficients		Standardized Coefficients		Sig.
		B	Std. Error	Beta	t	
1	(Constant)	8.497	1.974		4.305	.000
	Ent_Training	.491	.049	.634	10.021	.000
	Risk_Taking	-.033	.078	-.024	-.418	.676
	Innovativeness	.201	.055	.224	3.678	.000

a. Dependent Variable: SME_Dev

5. Discussion on Findings

The findings of this study give high prominence to entrepreneurial training in complementing the other element in developing the entrepreneurship programme in Abuja Nigeria. It is worthy of note that the literature review underscores the importance and role of training in the activity of entrepreneurship project. Consequently, the outcome of this study has re-echoed the thoughts and findings of prior scholarly works of Zainol, Daud, Shamsu, Abubakar and Halim 2018 and Chowdhury, Alam and Arif (2013); Arisi-Nwugballa, Elom and Onyeizugbe (2016). Additionally, the findings reiterate the affirmative role of innovativeness in the cause of developing SME in Abuja Nigeria. The outcome of this extant research suggests that entrepreneurial innovativeness has a significant relationship with SMEs development and performance in Abuja, Nigeria. The results provide support for the view that Innovativeness has significant influence on SME development and performance in Abuja. This finding is consistent with Ukpabio and Siyanbola, (2017).

6. Conclusion and Recommendation

On the basis of the findings of the empirical study, the researcher made several recommendations to guide business owners in Abuja, Nigeria. The results of this study show that both entrepreneurial training and innovativeness are significant to SME development and performance. Therefore, entrepreneurial training should be taken seriously by SMEs operators as the business world experience is much more than academic exercise.

Furthermore, SMEs operators should find a way to innovate if they must survive the harsh and competitive business environment. Finally, as much as it lies within the power of the SME operator, the owner should avoid uncalculated risk, as not all risks are worth taking.

References

- Abdul, O. E. (2018). Entrepreneurial skills and growth of Small and Medium Enterprise (SMEs): A comparative analysis of Nigerian entrepreneurs and Minority entrepreneurs in the UK. *International Journal of Academic Research in Business and Social Sciences*, 8(5), 27-46.
- Aguinis, H., & Kraiger, K. (2009). Benefits of Training and Development for Individuals and Teams, *Organizations and Society. Annual Review of Psychology*, 60, 451-474.
- Ahimbisibwe, Godwin M., & Abaho, E. (2013). Export entrepreneurial orientation and export performance of SMEs in Uganda. *Global Advanced Research Journal of Management and Business Studies*, 2(1), 056-062.
- Aigboduwa, J. E., & Oisamoje, M. D. (2013). Promoting small and medium enterprises in the Nigerian oil and gas industry. *European Scientific Journal*, ESJ, 9(1).
- Arisi-Nwugballa, E. A., Elom, M. E., & Onyeizugbe, C. U. (2016). Evaluating the relevance of entrepreneurial orientation to the performance of micro, small and medium enterprises in Ebonyi State, Nigeria. *International Journal of Academic Research in Accounting, Finance and Management Science*, 6(3), 222-234.
- Arshad, A. S., Rasli, A., Arshad, A. A., & Zain, Z. M. (2014). The impact of entrepreneurial orientation on business performance: A study of technology-based SMEs in Malaysia. *Procedia-Social and Behavioral Sciences*, 130, 46-53.
- Asenge, E. L., Diaka, H. S., & Soom, A. T. (2018). Entrepreneurial mind-set and performance of small and medium scale enterprises in Makurdi Metropolis, Benue State-Nigeria. *International Journal of Innovation: IJI Journal*, 6(2), 124-146.

- Azudin, A. & Mansor, N. (2017). Management accounting practices of SMEs: The impact of organizational DNA, business potential and operational technology. *Asia Pacific Management Review*, 23(3), 222-226. <https://doi.org/10.1016/j.apmr.2017.07.014>
- Bilau, A. A., Ajagbe, A. M., Kigbu, H., & Sholanke, A. B. (2015). Review of shortage of skilled craftsmen in small and medium construction firms in Nigeria. *Journal of Environment and Earth Science*, 5(15).
- Bowen, M., Morara, M., & Mureithi, M. (2009). Management of business challenges among small and micro enterprises in Nairobi-Kenya. *KCA journal of business management*, 2(1).
- Carree, M. A., & Thurik, A. R. (2005). *Understanding the role of entrepreneurship for economic growth* (No. 1005). Papers on Entrepreneurship, Growth and Public Policy.
- Chowdhury, M. S., Alam, Z., & Arif, M. I. (2013). Success factors of entrepreneurs of small and medium sized enterprises: Evidence from Bangladesh. *Business and Economic Research*, 3(2), 38.
- Cooper, D. R., & Schindler, P. S. (2014). *Business Research Methods*. The McGraw– Hill Companies.
- Cronbach, L. J. (1951). Coefficient alpha and the internal structure of tests. *Psychometrika*, 16(3), 297-334.
- Demirbas, D., Hussain, J. G., & Matlay, H. (2011). Owner-managers' perceptions of barriers to innovation: empirical evidence from Turkish SMEs. *Journal of Small Business and Enterprise Development*, 18(4), 764-780.
- Denscombe, M. (2014). *The good research guide: for small-scale social research projects*. McGraw-Hill Education (UK).
- Dess, G. G., & Lumpkin, G. T. (2005). The role of entrepreneurial orientation in stimulating effective corporate entrepreneurship. *Academy of Management Perspectives*, 19(1), 147-156.
- Dipboye, R. L. (2018). Work Analysis. In *The Emerald Review of Industrial and Organizational Psychology*, 495-534. Emerald Publishing Limited.
- Dowling, M., O’Gorman, C., Puncheva, P., & Vanwallegem, D. (2019). Trust and SME attitudes towards equity financing across Europe. *Journal of World Business*, 54(6), 101003.
- Ebiringa, O. T. (2011). Entrepreneurship venturing and Nigeria’s economic development: The Manufacturing sector in focus. *International Journal of Business Management & Economic Research*, 2(6), 376-381
- Fassin, Y. (2008). SMEs and the fallacy of formalising CSR. *Business ethics: a European review*, 17(4), 364-378.
- Gambin, L., & Hogarth, T. (2016). The costs and benefits of apprenticeships to employers: policy, funding and training quality. In *Human resource management, innovation and performance* (pp. 80-94). Palgrave Macmillan, London.
- Gnyawali, D. R., & Park, B. J. (2009). Co-opetition and technological innovation in small and medium-sized enterprises: A multilevel conceptual model. *Journal of small business management*, 47(3), 308-330.
- Garavan, T. N. (1995). HRD stakeholders: Their philosophies, values, expectations and evaluation criteria. *Journal of European Industrial Training*, 19(10), 17-30.
- Gherghina, Ștefan Cristian, Botezatu Mihai Alexandru, Hosszu, Alexandra and Simionescu, Liliana Nicoleta (2020). "Small and Medium-Sized Enterprises (SMEs): The Engine of Economic Growth through Investments and Innovation." *Sustainability* 12, no. 1 (2020): 347.
- [http://smedan.gov.ng/images/NATIONAL SURVEY OF MICRO, SMALL & MEDIUM ENTERPRISES \(MSMES\).pdf](http://smedan.gov.ng/images/NATIONAL_SURVEY_OF_MICRO,_SMALL_&_MEDIUM_ENTERPRISES_(MSMES).pdf)
- Hakim, C. (2012). *Research Design: Successful Designs for Social Economics Research*. Routledge.
- Hassan, I. B., & Mugambi, F. (2013). Determinants of growth for women owned and operated micro enterprises: The case of Garissa, Kenya. *International Journal of Business and Commerce*, 2(7), 45-55.
- Havlíček, K., Thalassinou, I. E., & Berezkinova, L. (2013). Innovation Management and Controlling in SMEs. *European Research Studies Journal*, 16(4), 57-70.
- Hayenhjelm, M. (2006). Out of the ashes: hope and vulnerability as explanatory factors in individual risk taking. *Journal of Risk Research*, 9(03), 189-204.
- Hyland, M. E. (1988). Motivational control theory: An integrative framework. *Journal of Personality and Social Psychology*, 55(4), 642
- Iwu, C. G., & Opute, A. P. (2019). Eradicating Poverty and Unemployment: Narratives of Survivalist Entrepreneurs. *Journal of Reviews on Global Economics*, 8, 1438-1451.
- Kadiri, I. B. (2012). Small and medium scale enterprises and employment generation in Nigeria: the role of finance. *Kuwait Chapter of Arabian Journal of Business and Management Review*, 33(845), 1-15.
- Karlan, D., & Valdivia, M. (2011). Teaching entrepreneurship: Impact of business training on microfinance clients and institutions. *Review of Economics and statistics*, 93(2), 510-527.
- Keh, H. T., Nguyen, T. T. M., & Ng, H. P. (2007). The effects of entrepreneurial orientation and marketing information on the performance of SMEs. *Journal of business venturing*, 22(4), 592-611.
- Kessy, S., & Temu, S. S. (2010). The impact of training on performance of micro and small enterprises served by microfinance institutions in Tanzania. *Research Journal of Business Management*, 4(2), 103-111.
- Khan, M. W. J., & Khalique, M. (2014). An overview of small and medium enterprises in Malaysia and Pakistan: past, present and future scenario. *Business and Management Horizons*, 2(2), 38-49.

- Kim, Y. & Ployhart, R.E. (2014). The effects of staffing and training on firm productivity and profit growth before, during and after the Great Recession. *Journal of Applied Psychology*, 99(3), 361-389. DOI: 10.1037/a0035408361.
- Kim, Y., & Vonortas, N. S. (2014). Managing risk in the formative years: Evidence from young enterprises in Europe. *Technovation*, 34(8), 454-465
- Kirby, D. A., & Kaiser, S. (2003). Joint ventures as an internationalization strategy for SMEs. *Small Business Economics*, 21(3), 229-242.
- Kirby, D. A. (2004). Entrepreneurship education: can business schools meet the challenge? *Education+ training*, 46(8/9), 510-519.
- Kraiger, K., Passmore, J., Dos Santos, N. R., & Malvezzi, S. (Eds.). (2014). *The Wiley Blackwell handbook of the psychology of training, development, and performance improvement*. John Wiley & Sons.
- Kumar, R. S., & Subrahmanya, M. B. (2010). Influence of subcontracting on innovation and Economic performance of SMEs in Indian automobile industry. *Technovation*, 30(11-12), 558-569.
- Kusumawardhani, A., McCarthy, G., & Perera, N. (2009). Framework of entrepreneurial orientation and networking: a study of SMEs performance in a developing country.
- Lawal, F. A., Adegbuyi, O. A., Iyiola, O. O., Ayoade, E. O., & Taiwo, A. A. (2018). Nexus between Informal Networks and Risk-Taking: Implications for Improving the Performance of Small and Medium Enterprises (SMEs) in Nigeria. *Academy of Strategic Management Journal*, 17(2).
- Lindh, I., & Thorgren, S. (2016). Entrepreneurship education: the role of local business. *Entrepreneurship & Regional Development*, 28(5-6), 313-336.
- Long, R. G., & Chrisman, J. J. (2014). *Management succession in family business* (pp. 371-387). Sage Publications: London, UK.
- Luo, P.F.; Wang, H.M.; Yang, Z.J. Investment and financing for SMEs with a partial guarantee and jump risk. *European Journal of Operations Research*. 2016, 249, 1161–1168.
- Lupton, D. (2006). *Sociology and risk. Beyond the risk society: Critical reflections on risk and Human security*, 11-24.
- Lyng, S. (2014). Action and edgework: Risk taking and reflexivity in late modernity. *European Journal of Social Theory*, 17(4), 443-460.
- Mbugua, J. K., Mbugua, S. N., Wangoi, M., Ogada, J. O., & Kariuki, J. N. (2013). Factors affecting the growth of micro and small enterprises: A case of tailoring and dressmaking enterprises in Eldoret. *International Journal of Business and Social Science*, 4(5).
- Mohrenweiser, J., & Backes-Gellner, U. (2010). Apprenticeship training: for investment or substitution?. *International Journal of Manpower*, 31(5), 545-562.
- Morris, M. H., Kuratko, D. F., & Covin, J. G. (2010). *Corporate entrepreneurship & innovation*. Cengage Learning.
- Mugenda, O., & Mugenda, A. (2003). *Research methods: Quantitative and qualitative approaches*. 2nd Nairobi: Nairobi: Act press pp45-49.
- Munene, B. G. (2013). *Impact of entrepreneurial training on performance of micro, small and medium enterprises in Nakuru County* (doctoral dissertation, Kenyatta University).
- Mungai, B. (2012). *The Relationship between Business Management Training and Small and Medium-Sized Enterprises' Growth in Kenya*. Unpublished PhD Thesis, Kenyatta University.
- Musawa, M. S., & Wahab, E. (2012). The adoption of electronic data interchange (EDI) technology by Nigerian SMEs: A conceptual framework. *Journal of Business Management and Economics*, 3(2), 55-68
- Naldi, L., Nordqvist, M., Sjöberg, K., & Wiklund, J. (2007). Entrepreneurial orientation, risk taking, and performance in family firms. *Family business review*, 20(1), 33-47.
- Namusonge, M. (2006). *The role of entrepreneurship, education and training in stimulating entrepreneurial careers*. In 3rd International Entrepreneurship Conference organized by United States International University (USIU), Nairobi.
- Ndiaye, N., Razak, L. A., Nagayev, R., & Ng, A. (2018). Demystifying small and medium enterprises' (SMEs) performance in emerging and developing economies. *Borsa Istanbul Review*, 18(4), 269-281.
- Nduta, K. M. (2016). *Influence of entrepreneurial training on business growth of small and medium enterprises among youth driven initiatives in Nairobi County, Kenya*.
- Noe, R.A., Clarke, A.D.M., & Klein, H.J. (2014). Learning in the twenty-first-century workplace. *Annual Review of Organizational Psychology and Organizational Behaviour*, 1, 245-275. DOI: 10.1146/annurev-orgpsych-031413-091321.
- Nwankwo, S., Akunuri, J., & Madichie, N. O. (2010). Supporting black businesses: narratives of support providers in London. *International Journal of Entrepreneurial Behaviour & Research*, 16(6), 561-580.
- Obi, J., Ibidunni, A. S., Tolulope, A., Olokundun, M. A., Amahian, A. B., Borishade, T. T., & Fred, P. (2018). Contribution of small and medium enterprises to economic development: Evidence from a transiting economy. *Data in brief*, 18, 835-839.

- Ogundele, O. J. K., Akingbade, W. A., & Akinlabi, H. B. (2012). Entrepreneurship training and education as strategic tools for poverty alleviation in Nigeria. *American International Journal of Contemporary Research*, 2(1), 148-156.
- Oke, A., Burke, G., & Myers, A. (2007). Innovation types and performance in growing UK SMEs. *International Journal of Operations & Production Management*, 27(7), 735-753.
- Okpara, J. (2009). Entrepreneurial orientation and export performance: evidence from an emerging economy. *International Review of Business Research Papers*, 5(6), 195-211.
- Oly Ndubisi, N., & Iftikhar, K. (2012). Relationship between entrepreneurship, innovation and performance: Comparing small and medium-size enterprises. *Journal of Research in Marketing and entrepreneurship*, 14(2), 214-236.
- Opute, A. P. (forthcoming - 2019). Small and Medium Enterprises Marketing: Innovation and Sustainable Economic Growth Perspective, in *Entrepreneurship Marketing: Principles and practice of SME Marketing*. Routledge Publishers.
- Owusu-Frimpong, N., & Nwankwo, S. (2012). Service quality orientation: an approach to diffusing mindfulness in SMEs. *International Journal of Quality & Reliability Management*, 29(6), 681-698.
- Oyelaran-Oyeyinka, B., & McCormick, D. (2007). *Industrial clusters and innovation systems in Africa*. United Nations University Press.
- Oyelaran-Oyeyinka, B., Adelaja, M., & Abiola, B. (2007). *SMEs Clusters in Nigeria: Institutions, Policies and Support Systems*.
- Perez-Gomez, P.; Arbelo-Perez, M.; Arbelo, (2018). A. Profit efficiency and its determinants in small and medium-sized enterprises in Spain. *BRQ Bus. Res. Q.* 21, 238–250.
- Perrini, F. (2006). SMEs and CSR theory: Evidence and implications from an Italian perspective. *Journal of business ethics*, 67(3), 305-316.
- Pretorius, M., Nieman, G., & Van Vuuren, J. (2005). Critical evaluation of two models for entrepreneurial education: An improved model through integration. *International Journal of Educational Management*, 19(5), 413-427.
- Rasborg, K. (2012). ‘(World) risk society’ or ‘new rationalities of risk’? A critical discussion of Ulrich Beck’s theory of reflexive modernity. *Thesis eleven*, 108(1), 3-25.
- Rhee, J., Park, T., & Lee, D. H. (2010). Drivers of innovativeness and performance for innovative SMEs in South Korea: Mediation of learning orientation. *Technovation*, 30(1), 65-75.
- Ritchie, J., Lewis, J., Nicholls, C. M., & Ormston, R. (Eds.). (2013). *Qualitative research practice: A guide for social science students and researchers*. Sage.
- Robson, P. J., Haugh, H. M., & Obeng, B. A. (2009). Entrepreneurship and innovation in Ghana: enterprising Africa. *Small Business Economics*, 32(3), 331-350.
- Rosenbusch, N., Brinckmann, J., & Bausch, A. (2011). Is innovation always beneficial? A meta-analysis of the relationship between innovation and performance in SMEs. *Journal of business Venturing*, 26(4), 441-457.
- Saunders, M., Lewis, P. and Thornhill, A. (2009). *Research Methods for Business Students*. (5th edition). Harlow: FT Prentice Hall.
- Sekaran, U. (2003). *Research Methods for Business: A Skill Building Approach*, 4th Edition, Wiley, Singapore.
- Sekaran, U., & Bougie, R. (2010). *Research Methods for Small Business. A Skill Building Approach*.
- Smit, Y., & Watkins, J. A. (2012). A literature review of small and medium enterprises (SME) risk management practices in South Africa. *African journal of business management*, 6(21), 6324.
- Sosna, M., Treviño-Rodríguez, R. N., & Velamuri, S. R. (2010). Business model innovation through trial-and-error learning: The Nature-house case. *Long range planning*, 43(2-3), 383-407.
- Sterelny, K. (2012). *The evolved apprentice*. MIT press.
- Syed, A. A. S. G., Ahmadani, M. M., Shaikh, N., & Shaikh, F. M. (2012). Impact analysis of SMEs sector in economic development of Pakistan: A case of Sindh. *Journal of Asian Business Strategy*, 2(2), 44-53.
- Tajeddini, K. (2014). The effect of organisational structure and hoteliers’ risk proclivity on innovativeness. *Asia-Pacific Journal of Management Research and Innovation*, 10(1), 1-12.
- Terziovski, M. (2010). Innovation practice and its performance implications in small and medium enterprises (SMEs) in the manufacturing sector: a resource-based view. *Strategic Management Journal*, 31(8), 892-902.
- Teschendorff, A. E., Sollich, P., & Kuehn, R. (2014). Signalling entropy: A novel network-theoretical framework for systems analysis and interpretation of functional omic data. *Methods*, 67(3), 282-293.
- Thurik, A. R. (2009). *Entrepreneurship: entrepreneurship, economic growth and policy*. Entrepreneurship, growth, and public policy, 219-249.
- Trimi, S., & Berbegal-Mirabent, J. (2012). Business model innovation in entrepreneurship. *International Entrepreneurship and Management Journal*, 8(4), 449-465.
- Ukpabio, M., & Siyanbola, W. O. (2017). Technological Innovation and Performance of Manufacturing Firms in Nigeria. *International Journal of Innovative Research and Advanced Studies*, 4(11), 10-19.

- Van Vuuren, J. J., & Nieman, G. H. (1999, June). Entrepreneurship education and training: A model for syllabi/curriculum development. In 44th ICSB World Conference Proceedings.
- Wambugu, A.K., Gichira, R., Wanjau, K.N. & Mungatu, J. (2015). The relationship between risk-taking and small and medium agro processing enterprises in Kenya. *International Journal of Economics, Commerce and Management*, 111(12), 441-455.
- Wiengarten, F., Fynes, B., Cheng, E. T., & Chavez, R. (2013). Taking an innovative approach to quality practices: exploring the importance of a company's innovativeness on the success of TQM practices. *International Journal of Production Research*, 51(10), 3055-3074.
- Winfred Agbeibor (2006) Pro-poor economic growth: Role of small and medium sized enterprises, *Journal of Asian Economics*, Volume 17, Issue 1, Pages 35-40, ISSN 1049-0078, <https://doi.org/10.1016/j.asieco.2006.01.005>.
www.raosoft.com/samplesize.html
- Xu, P. (2015). Risk taking and firm growth. RIETI Discussion Paper 15-E-061.
- Yoshino, N., & Taghizadeh-Hesary, F. (2019). Optimal credit guarantee ratio for small and medium-sized enterprises' financing: Evidence from Asia. *Economic Analysis and Policy*, 62, 342-356.
- Zainol, F. A., Daud, W. N. W., Shamsu, L., Abubakar, H. S., & Halim, H. A. (2018). A linkage between entrepreneurial leadership and SMEs performance: An integrated review. *International Journal of Academic Research in Business and Social Sciences*, 8(4), 104-118.
- Zhu, X., Yuan, Q., & Zhang, W. (2018). Inventory leanness, risk taking, environmental complexity, and productivity: A mediated moderation model. *Journal of Manufacturing Technology Management*, 29(7), 1211-1232.
- Zinn, J. O. (2015). Towards a better understanding of risk-taking: Key concepts, dimensions and perspectives.
- Zinn, J. O. (2016). Risk taking. *Routledge Handbook of Risk Studies*, 344
- Zwingina, T. C., Opusunji, M.I. and Akyuz, M. (2017). Impact of Foreign Trade Policy on Manufacturing Sector Growth in Nigeria.



The Effect of Audit Quality on Financial Performance of Deposit Money Banks (Evidence from Nigeria)

Chukwuma C. Ugwu¹, Lilian N. Aikpitanyi², Sonia Idemudia³

^{1,2,3} Department of Accounting, Faculty of Humanities, Management and Social Sciences, Federal University, Wukari, Nigeria

Correspondence: Chukwuma C. Ugwu. Email: ucollins98@yahoo.com

Abstract

This study examines the impact of audit quality on the financial performance of all the 15 listed DMBs in Nigeria from 2011-2017. Independent variables used are audit firm size, joint audit and audit fee, while ROA, proxy for financial performance, is the dependent variable. Secondary data were used, which were extracted from the financial statements of the listed DMBs. The study employed correlation and ex-post facto research designs and multiple regressions were used for data analysis. The study revealed significant and positive relationship between audit firm size and ROA, negative and significant relationship between joint audit and ROA and negative and insignificant relationship between audit fee and ROA. The study, therefore, recommends that since joint audit showed significant relationship with firm performance in this regard regulatory bodies should try to make joint audit compulsory and any firms that fail to comply should be sanctioned. The study also recommends that since audit firm size positively and significantly affects firm performance. Smaller audit firm should be encouraged as they are likely to carry out a more thorough audit assignment, because most of the DMBs engaged the service of the bigger audit firm.

Keywords: Audit quality, Financial performance, Deposit Money Banks

Background to the Study

Deposit Money Banks (DMBs) generally are motivated to have a high financial performance, which will attract more investors. Auditors are most likely to affect the quality of accounting information of DMBs; they can affect it positively or negatively depending on the quality of their work and their firm. One of the factors that can trigger their financial performance is quality auditing of their financial statements, which is for public consumption.

Audit quality is vital for DMBs to achieve efficient and effective resources management because it can lead to rapid improvement of firm's financial performance. The functions of external auditors reflect on the quality of financial report or information that firms maintain to create confidence among the stakeholders and reflect the efficiency, effectiveness and credibility of audit firms (Kwabena, 2017). Shehu and Musa (2014) assert that financial statement users, including current and potential investors, creditors and others, need reliable financial information on which to make investment decisions. As a result, when investors have confidence and trust in the

audited financial statements of a firm, they are bound to invest the more into the firm believing that their investment is secure, which in turn results in increased financial performance.

Miettinen (2011), is of the view that audit quality arouses the interest of the internal financial statement users such as management, audit committees and board of directors because they believe that it helps in reducing cost of capital. Dangana (2014) noted that one of the critical roles of auditors is that, they assure confidence to financial statements users about the reported information. Audit services have been critical to financial reporting quality and financial performance since industrial revolution.

However, Krishnan (2003), holds that the ability of auditors or audit firms to provide high audit quality capable of producing high financial reporting quality is attributed to some features of the audit firm which may include; audit firm size, audit fee and joint audit services.

Audit firm size is conceived as financially independent and highly experienced, thus less likely to be subjected to any pressure from the clients “to look the other way” in their role in discovering accounting irregularities (DeAngelo, 1981).

Moreover, Big 4 auditors have more to lose should a scandal arise, in that their brand names and reputations are more valuable compared with small non-Big 4 audit firms. Becker, Defond, Jiambalvo and Subramanian (1998), and Francis, Maydew and Sparks (1999) opined that Big 4 audit firms have shown to have higher accrual quality (Financial reporting quality) as measured by lower absolute values of discretionary accruals, and their clients are less likely to manage earnings.

Another audit quality features found to be related with financial performance is the fee paid to auditors (DeAngelo, 1981). According to this feature, quality may decrease with fee dependence if marginal forces associated with managerial influence overwhelm those associated with the scope of activities involved (Frankel, Marilyn & Karen, 2002; Francis, 2004). On the contrary, audit fee is used as a measure of audit quality. Based on this view, audit fees reflect additional audit effort, which leads to a higher level of audit quality (DeAngelo, 1981; Carcello, Hermanson, Neal & Riley, 2002). Audit firms charge their fee based on the quantum of the work to be done, standard of their report, their reputation, among others that indicate the quality of the audit firms.

Audit firm characteristics with respect to clients include the joint audit, to ensure objective financial performance and audit quality as well. Joint audits create more differences in auditor choice and potentially in the level of financial performance than under non-joint audit. Based on joint audit perspective, DeAngelo (1981) states that audit performed by two audit firms produce the highest quality financial performance and financial reporting, while the lowest level of quality occurs when a single audit firm is responsible for the audit engagement.

Ibrahim (2017) holds that investors and all stakeholders use financial statements, which provide information about the economic activities of an entity for major decision-making such as investment decision, tax purpose among others. One of the vital variables of financial reports that investors use for efficient decision-making is the financial performance which is expected to be reliable, verifiable, understandable and timely.

(Shehu, 2013) holds the view that a quality accounting information gives certainty that the report provided is sensibly free from error and bias and it truly represents what it intends to represent and the presentation is not misleading or ambiguous to users. Investors and other users are interested in high quality financial report for effective decision-making (Ibrahim, 2017).

The study focuses on three major audit quality attributes which will include; audit firm size, audit fee, and joint audit against Return on Assets (ROA) using data from the DMBs in Nigeria. This was informed based on the fact that Nigeria does not give concern in the corporate accounting scandals that caused the collapse of some of these banks like; Oceanic Bank, Savannah bank, Society-General Bank, Afribank Plc, among others. These banks collapsed even when their financial report did not show any signal of collapse despite the auditors’ endorsement that the financial reports are true and fair, and are in accordance with the relevant rules and regulation.

Deposit Money Banks deal with heavy assets and large volumes of transactions and as such, their management can use these large transactions to hide accounting irregularities, misstatement and earnings management, which have an adverse effect on financial performance (Shehu, 2011; Augustine, 2014). Therefore, the adverse consequence of poor financial performance and the need to ensure high-quality financial performance motivated the cause for this study.

Objectives

Generally, Deposit Money Banks (DMBs) are motivated to have a high financial performance to be able to attract more investors. The apostles of Audit quality hold the view that it is vital for organizations to achieve efficient and effective resources management because it can lead to rapid improvement of firm's financial performance. Audit quality can affect financial performance positively or negatively depending on the quality of their work and their firm. The objective of this study is to investigate the effect of audit quality on financial performance of listed DMBs in Nigeria. Yearly data were generated from 16 Deposit Money Banks listed on the NSE and Central Bank of Nigeria statistical bulletin between 2011 which was within the period of consolidation to 2017. Here the multiple regression was used to analyze the effect of Audit Quality on Financial Performance of Deposit Money Banks in Nigeria.

Conceptual Framework

The concepts discussed here are audit firm size, audit fee and joint audit. These are discussed in relation to ROA.

Concept of Return on Assets

According to Investor's Education Initiative (2016) return on Assets (ROA) is an indicator of how profitable a company is relative to its total assets. ROA gives an idea as to how efficient management is at using its assets to generate earnings. Calculated by dividing a company's annual earnings by its total assets, ROA is displayed as a percentage.

Sometimes, ROA is referred to as "Return on Investment" (ROI). ROA tells what earnings were generated from invested capital (assets). ROA for public companies can vary substantially and will be highly dependent on the industry.

This is why when using ROA as a comparative measure, it is best to compare it against a company's previous ROA numbers or the ROA of a similar company (Investor's Education Initiative, 2016). The assets of a company are financed by both debt and equity. The ROA gives investors an idea of how effectively a company is converting the money it has to invest into net income. The higher the ROA the better, because the company is earning more money on less investment.

Rosikah, Dwi, Dzulfikri, Muh and Azis (2018) opine that ROA is used to measure a company's capability to create profits using total owned assets by the company in the future, higher ROA shows that company is very effective and this is a positive sign for investors to invest their stock in the company, and thus increase the company's stock in the capital market.

Audit Fee and Return on Assets

Divergent views in literature depict that audit fees have a relationship with the financial performance of firms to some extent in that, financial performance is usually affected by fees paid to external auditors. For instance, quality might decrease with fees if marginal forces associated with managerial influence overwhelm those associated with the scope of activities or reputational incentives. If these forces ultimately reverse, then financial performance can also share a positive relationship with the audit fee. For instance, Francis and Ke (2003) and Reynolds and Francis (2004) found that the audit fee does have a negative relationship with financial performance, and thus improve the quality of financial reporting. They dispute the belief that audit fees erode independence.

Audit fees are also used as a measure of audit quality since they reflect additional audit effort which leads to a higher level of audit quality (Carcello, Hermanson, Neal & Riley 2002).

Audit firm Size and Return on Assets

Audit firm size has a positive effect on firm financial performance because many stakeholders believe that firms that are audited by the Big Four are free from material misstatement, which encourages and boost their confidence to invest more of their money in such firms. The most common and well-researched indicator of audit quality characteristics is whether an audit firm is one of the “Big 4” (DeFond & Francis, 2005).

Joint Audit and Return on Assets

Some scholars are of the view that the appointment of joint auditors to a firm will enhance its financial performance. Specifically, based on DeAngelo’s (1981) framework, audits performed by two big audit firms produce the highest-quality financial report, while the lowest level of quality occurs when a single non-big audit firm is responsible for the audit engagement.

Lesage, Ratzinger-Sakel, and Kettunen (2012) examined the struggle over joint audit: on behalf of public interest; they observed that firms that continue to use joint audits are associated with significantly higher audit fees compared with firms voluntarily choosing to use a single auditor. Similarly, Marmousez (2009) examines the impact of joint auditor pairs in France on financial reporting quality, measured by the degree of earnings conservatism. He provides evidence that Big 4–Big 4 auditor pairs are not associated with earnings conservatism whereas Big 4–non-Big 4 auditor pairs are associated with conservatism.

Theoretical Framework

This study will be anchored on a number of theories;

Agency Theory

This theory was first used by Stephen Ross and Barry Mitnick in 1973. Agency theorists advocate the separation of ownership from control in modern business which creates conflicts of interest between managers and stakeholders. The most cited reference to the theory, however, came from Michael C. Jensen and William Meckling.

According to the agency theory, to ensure the effectiveness of an audit process, managers are encouraged to prepare financial statements adequately to specify the return generated by the companies. Jensen and Meckling (1976) states that in agency theory, agents have more information than principals do and this information asymmetry adversely affects the principals’ ability to monitor whether or not the agents are properly serving their interests.

Sarens and Abdolmohhamadi (2007) opined that an assumption of agency theory is that principals and agents act rationally to maximize their wealth. A consequence of this is the moral hazard issue. Jensen and Meckling (1976) opine that moral hazard constitutes a situation where to maximize their own wealth agents may face the dilemma of acting against the interests of their principals. Since principals do not have access to all available information at the time a decision is being made by an agent, they are unable to determine whether the agent’s actions are in the best interest of the firm. To reduce the likelihood of the moral hazard, principals and agents engage in contracting to achieve optimality, including the establishment of monitoring processes such as auditing.

Watts (1998) observes that auditing is considered as a bonding cost paid by agents to a third party to satisfy the principal’s demand for accountability. Like any other cost of running the business, the cost of auditing is borne by principals to protect their economic interests.

Defond (1992) discusses the importance of the separation of ownership and control. He states that the more diffused the ownership of a company is the higher the divergence in preferences of the owners and managers, and the higher the observation and control of agents' actions by the principals. Thus, as the diffusion of ownership increases, so does the demand for monitoring. Thus, numerous auditing processes ought to monitor the agent's actions in more diffused ownership structures.

Louise (2005) states that audits serve as a fundamental purpose in promoting confidence and reinforcing trust in financial information, the principal-agent relationship as depicted in agency theory is important to understand how the role of an auditor has developed. Principals appoint agents and delegate some decision-making authority to them. In so doing, the principals place their trust in their agents to act in the principals' best interests. However, because of information asymmetries between principals and agents differing motives, principals may lack trust in their agents and may, therefore, need to put in place mechanisms, such as the audit, to reinforce this trust. Agency theory, therefore, is a useful economic theory of accountability, which helps to explain the development of audit quality.

Empirical Studies

Tom and Ying (2018) studied the effect of audit quality on a firm's financial performance in China from 2010 to 2016. The study used audit size, audit fee and leverage as independent variables and Return on Investment as a dependent variable. The data employed in the study was secondary data using multiple regression to analyse the data. It was revealed that audit size and audit fees are positively correlated with ROI, although the correlation is not significant at traditional while leverage is negatively and insignificantly related to ROI.

Kwabena (2017) studied the effect of internal audit quality on firm's financial performance in Kenya from the period of 2010 to 2016. The study used primary and secondary data. Firm size, financial leverage and liquidity were used as independent variables and return on equity as dependent variable. The study used 121 listed firms on Nairobi Stock Exchange (NSE). Multiple regressions were used to analyse the data. The study revealed that firm size, leverage and liquidity have significant impact on return on equity. The study recommended that in order to implement good internal audit, managers need to know that they should be concerned about interrelation between internal audit and financial performance in order to improve the financial performance of the firm.

Sylvester and Eyesan (2017) studied the impact of audit quality on earnings management in Nigerian DMBs. The study used 18 banks quoted on the NSE as at December, 2010 as sample of the study. Data was gathered for the period 2005 to 2010. The cross-sectional year-by-year regression analysis was used to analyse the data. Audit quality was measured using audit fees and auditor change, and abnormal loan loss provision was used to measure earnings management.

The results show that both audit fees and auditor change were positively and significantly related to abnormal loan loss provision. This suggests that high audit fees and changes in auditor tenure will aggravate earnings management. The study recommended that auditor change should not be ceremonial but based on the fact of inefficiency and audit fee from each auditor client should be monitored to enforce the five percent maximum from each client as suggested by Institute of Chartered Accountants of Nigeria code of ethics of 2016.

Hirhyel (2017) studied the effect of audit firm attributes on earnings quality of listed consumer goods firms in Nigeria. The study used 13 firms as sample size. Earnings quality is the dependent variable; Modified Jones Models was used to measure earnings management. Industry specialized auditor, audit compensation, audit tenure and audit firm type are the independent variables. Data for the study were obtained from the audited annual report of the 13 sampled consumer goods firms for a period of 8 years covering 2007 to 2014. The study employed ordinary least square regressions as tool for analysis.

The result shows that industry specialized auditors and audit firms type have a significant positive influence on earnings quality of sampled firms. However, audit tenure and audit compensation have no significant influence on earnings quality of the firms. For consumer goods firms to achieve higher earnings quality and provide quality

financial information for effective decision making, it was recommended that they should employ the services of industry specialized auditors and big four audit firm types who have the capability of influencing the quality of earnings of the company.

Sim, Daw and Abu (2016) studied the effect of financial reporting and audit qualities on firm performance for 56 firms listed on the Malaysian stock market, selected from the construction sector for the period of 2010 to 2013. Data were collected from the published annual reports and their notes to the financial statements of the sampled firms. To assess the level of compliance with the provisions of the Financial Reporting Standard (FRS) in Malaysia, content analysis was carried out. The firm's engagement with established audit firms was used as a proxy for audit quality, and return on assets was used as a measure of firm performance. Panel data analysis was employed in analyzing the data and testing the stated hypotheses. The use of panel data reveals that practices of FRS by firms significantly and positively related to their financial performance. The results also indicate that audit quality has a significant positive impact on business financial success. The study, therefore, recommends that the management of listed construction firms improve their practices of FRS and employ the service of established audit firms in support of financial success.

Anil (2016) studied the effect of audit quality on corporate governance in industrial companies in Bursa Istanbul from 2011 to 2015. For this purpose, data of 41 industrial companies traded in Bursa Istanbul in 2015 were obtained from the companies' annual reports, financial statements and their institutional web sites. The study used free float, company age, independent board members and institutional investors as independent variables and audit firm size, firm size, financial leverage and CEO duality as dependent variables. The study employed multiple regression to analyse the data. The study revealed that firm size, the rate of institutional ownership, duration of trading time in stock exchange market, and company history variables were found statistically positive on audit quality. The study recommended that the independent auditing should have a quality process.

Cheong, Boon, Ongtze and Hong (2015) studied the relationship between audit quality, earnings management, and financial performance among public listed companies in Malaysia. 100 companies were randomly selected from the Industrial Products and Consumer Products industry listed on the Main Board of Bursa Malaysia during the period of 2008 to 2013. The study used audit size, audit fee and audit tenure as independent variables, discretionary accrual and absolute discretionary accrual as mediating variables and ROA as a dependent variable. The study uses multiple regressions to analyse the data.

The findings indicate that audit quality significantly impacts on ROA and earnings management and it does not actually constrain earnings management practices in Industrial Products and Consumer Products companies. It also reveals that the financial performance of larger-sized companies is better than that of smaller-sized companies. Shehu and Musa (2015) studied the impact of audit quality on financial performance of four quoted cement firms in Nigeria from 2007 to 2011. The study is descriptive in nature and the correlational and ex-post-facto designs were adopted in carrying out this research. Data were obtained from the published annual reports and accounts, and notes to the financial statements of the four sampled firms'. The data collected were quantified and presented in tables. Multiple regression analysis was employed in analyzing the data and testing the stated hypotheses. The study used auditor independence and audit size as independent variables, net profit margin as dependent and leverage as control variable.

The results of the findings show that auditor size and auditor independence have significant impacts on the net profit margin of the sampled firms, however, auditor independence has more influence than auditor size on the net profit margin. The study recommends that the management of quoted cement firms in Nigeria should increase the remuneration of auditors in order to improve their financial performance and the services of audit firms whose character and integrity are beyond question.

Dangana (2014) studied the impact of audit firms attributes on financial reporting quality of quoted building material firms in Nigeria. The study used 4 firms out of the 8 quoted building material firms, and employed correlation research design for the period of ten years (2002-2011). Ordinary Least Square (OLS) multiple regression techniques was employed in the analysis of the panel data collected for the study. The study used audit

compensation and audit firms independence as independent variables and financial quality which Jones models were used for the measurement as a dependent variable.

The study found that audit compensation and audit firm independence have significant positive impact on the financial reporting quality of sampled firms at 99% confidence level. The study concluded that, audit compensation and provision of non-audit services in the quoted building material firms in Nigeria improved the quality of their financial reporting during the period under review.

Morteza (2014) studied the effect of audit quality on the performance of 25 listed companies in Tehran Stock Exchange for the period of 2008 to 2012. The study used primary data. The researcher distributed and collected the questionnaires administered to respondents. It used multiple regressions. The study used audit fee and audit firm size as audit quality proxy (independent variables) and Return on Equity as firm performance proxy (dependent variable).

The study revealed that audit fee and audit size significantly and positively affects the ROE of the sampled companies.

Most literature focused on audit quality and financial reporting quality while few looked at audit effect of audit quality on financial performance. More to that no study used joint audits to examine the effect on ROA and none used ROA to measure financial performance. With regard to this topic of study, only Cheong, Boon, Ongtze and Hong (2015) used ROA but they did not use joint audit. ROA is an indication of how profitable a company is relative to its total assets. ROA gives managers, investors, or analysts' idea as to how efficient a company is and how well a company has performed.

In addition, numerous studies were conducted on the relationship between audit quality and earnings quality but only a few on audit quality and financial performance (Shehu & Musa, 2014). Some of these studies include Kwabena (2016), Lucy, Mungai and Susan (2016), Cheong, Boon Ong and Hong (2015) and Lulian, Florin and Laura (2014) which were conducted in Kenya, Kenya, Malaysia and Romania respectively. Only Shehu and Musa (2014) conducted study in Nigeria with regard to effect of audit quality on financial performance. However, most of the studies, which were conducted in developing countries including Nigeria, did not make use of Joint audits as an attribute of audit quality and only Shehu and Musa (2014) used audit fees as audit quality attributes against financial performance. Hence, this study attempt to include an important variable of audit attribute, which is joint audit, and audit fee that was not used by most of the studies conducted.

METHODOLOGY

The research design employed for this research is correlational and ex-post-facto designs. The design for the study is appropriate because it assists in determining the influence of audit quality on the financial performance of the DMBs in Nigeria. The general objective in this correlational and ex-post facto research design is to gain insight and generate a new ideas. The ex-post facto research design was used because the events have already occurred and variables not manipulated. Multiple Regression technique was also adopted as the tool of analysis as it is most appropriate for the study and because of its ability to use multiple independent variables to estimate their effect on a single dependent variable. The OLS method adopted in this study is a parametric statistical test that is based on a number of assumptions, the violation of which could affect the reliability of the results. The regression model was used because it assumed linearity and normality and it ascertains the impact of the independent variables on the dependent variable. Yearly data were generated from 16 Deposit Money Banks listed on the NSE and Central Bank of Nigeria statistical bulletin between 2011 which was within the period of consolidation to 2017. The model equation is stated in Error Correction Form to establish whether there will be a long-run effect of Audit Quality on the Financial Performance of Deposit Money Banks in Nigeria.

$$ROA_{it} = \beta_{0it} + \beta_1 AFS_{it} + \beta_2 AF_{it} + \beta_3 JA_{it} + \beta_4 FS_{it} + \beta_5 FS_{it} + \epsilon_{it}$$

Where

ROA = Return on Assets

β_0 = intercepts autonomous variable.

$\beta_1, \beta_2, \beta_3, \beta_4, \beta_5$ = the regression coefficients of the independent variable
 it= time for intercepts
 AFS = Audit Firm Size;
 AF = Audit Fees;
 JA = Joint Audit
 FS = Firm size;
 FA = Firm age;
 ϵ = Error Term

Results

Descriptive Statistics of Dependent and Independent Variables

Variables	Minimum	Maximum	Mean	Std. Deviation
ROA	-0.088	0.432	0.020	0.045
AFS	0.000	1.000	0.714	0.454
AF	3.180	5.250	4.174	0.427
JA	0.000	1.000	0.486	0.502
FS	6.916	22.650	17.833	3.562
FA	1.386	3.829	2.657	0.680

Source: STATA 14 Output:

Table 1 shows that the mean for ROA is 2% indicating the average level of ROA across the sampled DMBs. It also suggests that for every ₦1 use of assets generate 2% ROA in the sampled DMBs in Nigeria and the standard deviation of ROA is 0.045. The difference between the mean and the standard deviation is 0.025. This is an indication of wide variations in the ROA around the mean. It means that there is a significant variation in the ROA status of the sampled DMBs. The minimum and maximum are -0.083 and 0.432 respectively. This is an indication of a very wide range of 0.349. The range corroborates the revelation of the standard deviation that there is a very wide gap between the DMBs with regard to ROA some DMBs have low ROA and others with high ROA. The minimum value implies that other firms make a loss in some accounting years.

The table also indicates that on average 71.4% of the listed DMBs in Nigeria are audited by Big 4 audit firms as indicated by the mean value of 0.714 with a standard deviation of 0.454. While the minimum and maximum values are 0 and 1 respectively. The table also indicates that the minimum and maximum values of the natural log of audit firm fees are 3.180 and 5.250 respectively, with the mean value of 4.174 and standard deviation of 0.427. This shows that there is a dispersion of audit firm fees from the mean in the sample firms. In addition, the minimum and maximum values of the joint audit (JA) variable are 0 and 1 respectively. The average proportion of joint audit has the mean value of 0.486 and standard deviation of 0.502. This implies that about 48.60% of the listed DMBs in Nigeria employ joint audit services. It also suggests insignificant variation around the mean based on the standard deviation of 0.502.

The average firm size as indicated on the table as mean value is 17.833. The standard deviation is 3.562 indicating a very high variability among the size of sampled DMBs. It means that most of the DMSBs are not within the same range in terms of their total asset. The minimum and the maximum firm size are 6.916 and 22.650 respectively. This implies that the range is 15.734, indicating a very high range in a total asset owned by DMBs within the period of the study. The mean of age of the sampled DMBs is about 2.615, which indicates that the average age of the sampled firms from the date of listing with a minimum 1.386 and a maximum of 3.829. The standard deviation of 0.680 indicates that there is a significant difference between the ages of the firms.

Correlation

The results of Pearson correlation between the dependent and explanatory variables are presented in the table below:

Correlation matrix

	ROA	AFS	AF	JA	FS	FA	VIF
ROA	1.000						
AFS	0.003	1.000					1.00
AF	-0.188	-0.002	1.000				1.30
JA	-0.196	-0.018	0.074	1.000			1.05
FS	0.128	0.009	-0.278	-0.051	1.000		1.09
FA	-0.216	0.001	0.427	0.220	-0.143	1.000	1.28

Source: STATA 14 Output:

This section shows the relationship between the independent variable and the dependent variables. Absolute value of the correlation coefficient and larger value indicate strength and strong relationships. The result shows that the correlation coefficients on the main diagonal are 1.000 for all the variables, which indicate perfect and positive linear relationship that each variable has with itself.

It also shows that there is positive relationship between audit fees, joint audit, firm age, and ROA. This suggests that an increase in audit fees, joint audit and firm age does not lead to an increase in ROA. The relationship between audit firm size, firm size and ROA is positive. This implies that an audit firm size and firm size contributes positively to the ROA. It also shows that audit firm size and firm size moved in the same direction with ROA.

Analysis of Regression Results

This section presents the regression results of audit firm size, joint audit, audit fee (independent variables) and ROA (dependent variable).

Regression Result

ROA	Coefficient	Robust Std. Err	t-value	P-value
Const	0.0746	0.0501	1.49	0.140
AFS	0.0001	0.0065	0.02	0.983
AF	-0.0102	0.0109	-0.93	0.353
JA	-0.0045	0.0070	-0.64	0.522
Firm_size	0.0009	0.0007	1.26	0.211
Firm_age	-0.0099	0.0050	-1.96	0.053

R-Square = 0.0660

F-Ratio = 1.20

Prob. = 0.3167

Source: STATA 14 Output:

Table 4.3 presents the coefficients and t-statistics of OLS regression results. The results depict that the R^2 is about 7%, which gives the proportion, or percentage of the total variation in the dependent variable explained by the audit firm size, audit fee and joint audit of the sampled DMBs jointly. It signifies that 7% of the total variations in ROA of sampled DMBs are caused by their audit firm size, audit fee and joint audit, while the remaining 93% of the total variation in ROA was caused by factors not explained by the model.

Audit firm size has positive and insignificant impact on the ROA of the DMBs, from the coefficient of 0.090 with t-value of 0.020, which is statistically insignificant at t-value of 0.002 because is less than ± 1.96 the pre-selected level of significance. The results reveal that a unit increase in the size of the audit firm will lead to a 0.9% increase in the ROA of the DMBs.

Audit fee has negative and insignificant impact on the ROA of the DMBs, from the coefficient of -0.0102 with t-value of -0.93, which is statistically insignificant at t-value of 0.93 because it is less than ± 1.96 the pre-selected

level of significance. The results reveal that a unit increase in the audit firm fee will lead to a 1% decrease in the ROA of the DMBs.

The results also show that joint audit has a negative and insignificant impact on the ROA of the DMBs, from the coefficient of -0.0045 with t-value of -0.64, which is statistically insignificant at t-value of 0.64 because is less than ± 1.96 the pre-selected level of significance. The results reveal that a unit increase in the audit firm fee will lead to a .045% decrease in the ROA of the DMBs.

The result also revealed that there is a positive relationship between firms' size and ROA at beta coefficient value of 0.0009 with insignificant effect at t-value of 1.26. Lastly, the relationship between the ages of the firms is negative and significant at coefficient and t-value of -0.0099 and -1.96 respectively.

Discussion

Audit firm size and ROA

As shown in the result of the test of the hypothesis one, a positive and insignificant relationship was observed between audit firm size and ROA. The result, therefore, achieves objective one of the study and answers research question one of the study. This finding is not in line with or contradicts any of the reviewed literature because all the reviewed literature does not use ROA as the dependent variable.

Audit fee and ROA

The study hypothesized that there is no significant effect of audit fees on ROA of the listed DMBs in Nigeria. The regression results reveal the negative and insignificant effect of audit fees on ROA, implying that as audit fees decrease ROA insignificantly, suggesting that the higher audit fee, the lower the ROA. This result achieves objective two of the study and answers research question two of the study. This finding is not in line with or contradicts any of the reviewed literature because all the reviewed literature does not use ROA as the dependent variable.

Joint Audit and ROA

The study hypothesized that there is no significant effect of joint audits on ROA of the listed DMBs in Nigeria. The regression results reveal the negative and insignificant effect of joint audits on ROA. This result achieves objective three of the study and answers research question three of the study. The study found that financial performance during the period decrease as the use of joint audits increase. This finding is not in line with or contradicts any of the reviewed literature because all the reviewed literature does not use joint audits as independent variables and ROA as the dependent variable.

Available evidence from the result shows that audit firm size and ROA of listed DMBs in Nigeria are positively and insignificantly related while audit fees and joint Audits are negatively and insignificantly related to ROA of listed DMBs in Nigeria.

Conclusion

This study investigated the relationship between audit quality and the financial performance of DMBs in Nigeria. The results showed that audit quality has positive coefficients and insignificantly influences the firm's financial performance. Similarly, the result showed that audit firm size, audit fee, and joint audit had an insignificant and negative relationships with return on assets (ROA). Generally, the results revealed that audit quality does not add value to the financial performance of DMBs in Nigeria.

The results suggest important implications for practitioners and policymakers in Nigeria. One important and major implication is that, audit firm size, audit fee and joint audit do not improve significantly the financial performance of DMBs.

Recommendations

In view of the findings of the study, the following recommendations are hereby suggested; since audit firm size positively affects firm performance. Consequently, a smaller audit firms should be encouraged to carry out more thorough audit assignments not necessarily attaching them with the big audit firms, because most of the DMBs engaged the service of the bigger audit firm. Some of the smaller firms can performance better than the big ones in the sense they may wish to be considered as one of the big audit firms. It is important that regulatory bodies such as SEC, CBN among others should state how much should be paid to audit firms, based on the quality of work and also make joint audits compulsory for public companies, especially DMBs and sanction any firm that fails to comply.

References

- Anil, G. (2016). Relationship Between Audit Quality and Corporate Governance: An Empirical Research in Borsa Istanbul. *Journal of Business and Management*, 18(11), 84–88.
- Augustine, O. O., Famous, O. I. & Augustine O. E. (2014). Audit quality and accrual based earnings management of quoted companies in Nigeria. *IOSR Journal of Economics and Finance*, 2 (2), 07-16 www.iosrjournals.org
- Becker, C., DeFond, M., Jiambalvo, J., Subramanyam, K.R. (1998), 'The effect of audit quality on earnings management', *Contemporary Accounting Research*, Spring, Vol. 15 pp.1-24.
- Cheong, P. C., Boon, H. T., Ong, T.S & Hong, Y.H, (2015). The relationship among audit quality, earnings management, and financial performance of malaysian public listed companies. *International Journal of Economics and Management* 9 (1).
- Carcello, J. V., D. R. Hermanson, and R. A. Riley. (2002). Board characteristics and audit fees. *Contemporary Accounting Research* 19 (3): 365-384.
- Dangana, U. (2014). *Audit Attributes and Financial Reporting Quality of Listed Building Material Firms In Nigeria*. unpublished thesis submitted to the school of postgraduate studies, ahmadu bello university zaria, in partial fulfillment of the requirements for the award of master of science degree (m.sc) in accounting and finance.
- DeAngelo, L.E.(1981). Auditor size and audit quality. *Journal of Accounting and Economics* 3(3): 183-199
- DeFond, M.L.,& Francis, J.R. (2005). Audit research after Sarbanes-Oxley. *Auditing: A Journal of Practice & Theory*, 24 (supplement), 5-30.
- DeFond, M. and Francis, J. (1992). Audit research after Sarbanes-Oxley. *Auditing: A Journal of Practice & Theory* 24: 5-30.
- Francis, J.R. Ke, B. (2006). Disclosure of fees paid to auditors and the market valuation of earnings surprises. *Review of Accounting Studies*, 11, 495–523.
- Francis, J.R. (2004) 'What Do We Know about Audit Quality?', *The British Accounting Review*, 36(4): 345-368.
- Francis, J.R., Maydew, E.L., & Sparks, H.C. (1999). The role of big 6 auditors in the credible reporting of accruals. *Auditing: a Journal of Practice & Theory*, 18(2), 17-34.
- Frankel, R., Johnson, M. and Nelson. K. (2002) 'The relation between auditors' fees for nonaudit services and earnings management', *The Accounting Review*, 77 (Supplement): 71-105.
- Hiryel, A.I. (2017). *Effect of Audit Firm Attributes on Earnings Quality of Listed Consumer Goods Firms in Nigeria*. Being a dissertation submitted to the department of accounting Ahmadu Bello University, Zaria, Nigeria for the award of master of science (m.sc) degree in accounting and finance
- Jensen, M.C. and Meckling, W.H.: (1976) „Theory of the firm: managerial behaviour, agency costs and ownership structure“, *Journal of Financial Economics*, 3, pp.306-360.
- Krishnan, G., (2003). Does Big 6 auditor industry expertise constrain earnings management? *Accounting Horizons* 17, 1-16.
- Kwabena, K. A. (2017). *The Effects Of Internal Audit Quality On Financial Performance Of Firms Listed At The Nairobi Securities Exchange*. A Thesis submitted in Partial fulfillment of the requirement for the award of Master in Business Administration. Degree of the School of Business University of Nairobi.
- Lesage, C., Ratzinger-Sakel, N. and Kettunen, J. (2012) Struggle over joint audit: on behalf of public interest? Available at: <http://papers.ssrn.com/abstract/42176729> (accessed 12 November 2012).
- Louise, M. (2005). *The effects of auditor independence on audit quality*. Paper presented the Department of

- Accounting, Bowling Green State University
- Marmousez, S. (2009). *The choice of joint-auditors and earnings quality: Evidence from French listed companies*. CAAA Annual Conference 2009.
- Miettinen, J. (2011), The role of audit quality on the relationship between auditee's agency problems and financial information quality. Paper presented at the Department of Accounting and Finance, University of Vaasa, Finland
- Morteza, Z. (2014). *The effect of audit quality on the performance of listed companies in Tehran Stock Exchange*. 21, 36–43. <https://doi.org/10.18052/www.scipress.com/ILSHS.21.36>
- Mungai J. N., Lucy M. & Susan W. N. (2016), Effect of auditing on financial Performance of water and sanitation company in kirinyaga county, kenya, *Journal of Finance and Accounting* 2016; 4(5): 271-284, ISSN: 2330-7331 (Print); ISSN: 2330-7323 (Online)
- Rosikah, Dwi K. P., Dzulfikri A. M., Muh. I. A. and Miswar R. (2018); Effects of Return on Asset, Return On Equity, Earning Per Share on Corporate Value; *The International Journal of Engineering and Science (IJES)*; Volume 7, Issue 3 Vol. I; 2018 ISSN (e):2319 –1813ISSN (p):23-19 –1805
- Sarens, G. & Abdolmohhamadi, M. J. (2007). Agency theory as a predictor of the size of the internal audit function in Belgian Companies. *Paper presented at the Annual Congress of European Accounting Association in Lisbon*.
- Shehu, U.H., (2011), Corporate Governance and Financial Reporting Quality: A Study of Nigerian Money Deposit Bank, *International Journal of Research in Computer Application and Management (U.S.A)*, 1(6): 12-19 ISSN: 2231-1009
- Shehu, S. H. (2012). *Firm Characteristics and Financial Reporting Quality of Quoted Manufacturing Firms in Nigeria*. An Unpublished PhD Dissertation School of Postgraduate Studies Ahmadu Bello University, Zaria
- Shehu U. H. and Musa A. F. (2014), Firm Attributes and Earnings Quality of listed Oil and Gas Companies in Nigeria; American Research Institute for Policy Development; Review of Contemporary Business Research March 2014, Vol. 3, No. 1, ISSN: 2333-6412 (Print), 2333-6420 (Online) www.aripd.org/rcbr
- Sim, H. C., Daw, H.T., & Abu I.H. (2016). *Malaysia Financial Reporting Practices and Audit Quality Promote Financial Success : The Case of Malaysian Construction sector*. 1(1), 36–50.
- Sylvester, E. & Eyesan, L.D. (2017). Audit quality and Earnings Management in Quoted Nigerian Banks. *Journal of Accounting, Finance and Auditing Studies*.
- Tom, A., & Ying, Z. (2018). *The Effect of Audit Quality on a Firm's Internal Information Environment: Evidence from Group Audits*
- Watts, R. L. (1998). A review of agency problems, auditing and the theory of the firm. *Journal of Law and Economics*, 26 (3).



Determinant Return on Assets and Its Impact on Assets Growth (Case Study of Sharia General Banks in Indonesia)

M. Noor Salim¹, Hardian Arief Winanto²

¹1975801189@mercubuana.ac.id, m_noorsalim@yahoo.com, Mercubuana University, Jakarta Indonesia

²hardian_arief@ptpjb.com, hardian_arief@yahoo.com, PT Pembangunan Jawa Bali, Surabaya Indonesia

Abstract

This study aims to examine and analyze the determinants that influence Return on Assets (ROA) and their impact on Asset Growth (AG) partially or simultaneously. Factors affecting ROA and also Asset Growth are specific to Human Capital efficiency (HCE), Structure Capital efficiency (SCE) Capital Employed Efficiency (CEE), Board of Education (BED), and Board of Evaluation (BEV) on Return On Assets (ROA) and Asset Growth (AG). The population of this study is Sharia commercial bank companies in Indonesia with an observation period from 2014 to 2018 consisting of a sample of 12 Sharia Commercial Bank companies. The data analysis techniques in this study used Multiple Linear Regression analysis by analyzing the effect of corporate governance and Intellectual Capital to the Return On Asset and Asset Growth of the corporate partially and simultaneously. The results of data analysis showed that ROA was partially influenced by a significant positive of HCE and AG was significantly positive by ROA. While simultaneously, all variables significantly influence positively on ROA and Asset Growth.

Keywords: Human Capital Efficiency (HCE), Structure Capital efficiency (SCE), Capital Employed Efficiency (CEE), Board of Education (BED), Board of Evaluation (BEV), Return On Assets (ROA), Asset Growth (AG)

1. Introducing

This research was conducted because it saw a growing phenomenon in the country of Indonesia that the development of Islamic banks has increased since the last few years. The development of Islamic banks shows that public awareness of religion is increasingly high. The development of Islamic banks is not only determined by the amount of capital invested, but also to the readiness of employees of Islamic commercial banks in applying the principles of Islamic banking in accordance with Islamic teachings.

Slowly, Islamic commercial banks are able to meet the needs of the public who want banking services in accordance with sharia principles, particularly those relating to the prohibition of usury practices, non-productive speculative activities and violations of the principle of fairness in transactions and the necessity of channeling financing and investment in business activities which is ethically and halal in sharia. (Zubair, 2008).

Since the establishment of the first Islamic bank, another sharia bank began to emerge, which as of December 2018 there were 14 Islamic commercial banks in Indonesia with an average total asset of 298,044 billion rupiahs. (www.ojk.go.id).

Previous research has concluded that intellectual capital can be used to improve corporate financial performance, while corporate governance cannot be proven to be used to improve financial performance. (Ningrum, et al. 2012). That study was conducted on 54 financial companies listed on the Indonesian stock exchange.

In addition, Kurniasih, et.al (2016) concluded that if the company is able to manage the intellectual capital that they have better, the higher Return on Assets (ROA) can be made by the company.

Also research by Nuswandari (2009) focuses on the influence of corporate governance on company performance. The study was conducted on 101 companies listed on the Indonesia Stock Exchange with the period 2001 to 2005. In this study, it was concluded that the implementation of good corporate governance and in accordance with applicable regulations will make investors respond positively to the company's performance and increase the company's market value. (Nuswandari, 2009). In summary, it can be said that corporate governance affects the company's operating performance.

Tertius (2015), concludes that the board of commissioners, independent commissioners, and managerial ownership as joint control variables have a significant effect on the dependent variable that is ROA.

Meanwhile, previous research on asset growth in Islamic banks has been conducted by giving the results that the internal variables that significantly influence the growth of Islamic banking assets are only the number of offices, FDR ratio, and promotion costs, while for other internal variables, namely the NPF ratio and the amount of funds third parties do not significantly influence. (Syafrida, et al. 2011).

Based on the phenomena and previous studies, there is a research gap that the writer gets and is taken as a research theme. The author takes research by taking samples of Islamic commercial banks in terms of the application of corporate governance and intellectual capital, its implications for the company's financial performance. The governance examined is related to the number of board of directors and commissioners' meetings as well as director education, as well as intellectual capital with the variables Human Capital Efficiency (HCE), Capital Efficiency Structure (SCE), and Capital Employed Efficiency (CEE). The financial performance of Return On Assets (ROA) becomes an intervening variable on the variable Asset Growth (AG) of Islamic commercial bank companies.

Some previous studies that underlie the existence of this study include research by Tri Ciptaningsih (2013). The research aims to examine the effect of intellectual capital on the company's financial performance, where the variables analyzed are Intellectual Capital, VAIC, HR capital, structural capital and financial performance. The results of the study are that VAIC and HCE have no effect on the company's financial performance and CEE and SCE have a positive effect on the company's financial performance. (Ciptaningsih, 2013).

Previous research has been conducted on the relationship between the application of governance and corporate financial performance. Among them is Santoso's research (2017) which shows that the application of good corporate governance has a significant positive direct effect on company value. While in the same research it shows that Good Corporate Governance has a significant indirect effect on firm value by using financial performance (ROA) as an intervening variable. This research was conducted by taking samples of manufacturing companies in the logan, chemical and plastic packaging sectors listed on the Indonesia Stock Exchange (IDX) during 2011 to 2016 or as many as 54 companies.

Meanwhile, according to research conducted by Farida, et.al (2010), the results show that the application of corporate governance to earnings management in Indonesian banking companies has a significant effect only on the proxy for managerial ownership. Another result is the absence of a relationship between the application of corporate governance to financial performance mediated by management earnings actions in Indonesian banking companies. Taking the corporate governance variable is represented by the size of the board of commissioners, the composition of the independent board of commissioners, the audit committee, institutional ownership, and managerial ownership. This study takes a sample is an Indonesian banking company that listed on the Stock Exchange within the period from 2005 to 2007.

Research by Suroso, et.al (2017) states that there is a significant and significant influence of intellectual capital on the RPA and no effect on AG. Still, from the same study, Suroso, et. al (2017) states that for corporate governance has a positive influence on ROA and does not affect the growth of assets.

Intellectual Capital (IC)

Intellectual Capital is one of the intangible corporate assets. This intellectual capital is the development of the needs of a company that initially only relies on physical assets (tangible assets) which then develops with the need for intangible assets (intangible assets). Intellectual Capital is an intangible asset, which has no physical form, but has a value that can generate profits and can be a competitive advantage for organizations (Choong, 2008). This development makes intellectual capital as one of the capital in carrying out company operations as well as physical capital as before. The importance of the role and contribution of intangible assets can be seen in the comparison between book value and market value in knowledge-based companies. (S.W et, al. 2012).

Calculation of the efficiency and effectiveness of an intellectual capital against company profits, where intellectual capital provides added value to the company can be known by using the VAIC method. This method aims to create as much added value as possible with a number of physical capital and intellectual potential. (Pulic, 1998).

The calculation of the VAIC is $VAIC = ICE + CEE$ (Pulic, 2008) with the ICE are intellectual capital efficiency coefficient (HSE+SCE) and the CEE is the capital employed efficiency coefficient.

The main components of VAIC that can be seen from company resources, are human capital (VAHU - value added human capital), Structural Capital (STVA - structural capital value added), and physical capital (VACA - value added capital employed). (Kartika, et.al, 2013).

Part of intellectual capital is what is examined in this research is :

- 1) HCE
Human Capital Efficiency is capital related to the development of a company's human resources, such as competence, commitment, motivation, and employee loyalty. Human Capital shows the company's ability to manage human resources. (Salim et al., 2013).
- 2) Structure Capital Efficiency (SCE)
Structure Capital Efficiency shows the existing knowledge in a company that is human, such as: company routines, procedures, systems, culture and databases (Salim et. Al, 2013).
Structure Capital Efficiency is a development that has been carried out within the company and has become the culture of the company, so that it can be a strength in the future development of the company.
- 3) Capital Employed Efficiency (CEE)
Capital Employed shows a harmonious relationship with its partners, such as suppliers, customers, government, and surrounding communities (Salim et. Al, 2013). Capital Employed Efficiency is the amount of capital in the form of financial funds that have been invested into the company in order to carry out the company's operational activities that can create added value for the company.

Corporate Governance

Corporate governance is a system that is run and carried out by a company in managing, controlling, and daily activities. Good corporate governance is able to facilitate the interests and needs of all stakeholders or corporate stakeholders involved in the process and management of the company.

Corporate governance begins with the concept of separation between ownership and control. This separation led to agency theory, where between the two have different interests. Organizational theory and company policy are strongly influenced by agency theory that describes top managers as agents in a company, where these managers have different interests from the owner, still trying to maximize their respective satisfaction. (Jensen & Meckling (1976) in Raharjo, 2007)

The application of corporate governance has a relationship with company profits. Through a mechanism of good corporate governance, it is expected to be operated by higher earnings (Khafid, 2012).

Return On Asset

Return on Assets (ROA) according to Tandelilin (2010), is to illustrate the extent to which the ability of assets owned by a company can generate profits. ROA is measured by comparing net income with total assets. Edwin, et. al (2017). Meanwhile according to Kasmir (2010), Return On Assets is a ratio that shows the results of the total assets used in the company

Return on Assets Ratio (ROA) is the rate of return or profit of a company that is obtained compared with the assets owned by the company. Company performance is the result of implementing company policies such as ROA that will be used by investors and prospective investors as a basic for their decision to invest. (Salim, et. al, 2019)

Companies with high return on assets (ROA) will attract investors to invest their capital to the company because the company is considered to be more efficient in generating profits by utilizing all assets owned by the company. (Mulyana, et.al, 2017).

Asset Growth

Asset growth is growth in the value of assets owned by a company compared to the value of assets in the previous period. The company certainly hopes that the company's assets can increase along with the company's progress.

Asset growth can use a debt scheme or from company wealth. If the company uses debt, then the manager will be forced to issue cash from the company to pay interest. (Umadiyah, et. al. 2017).

2. Material and Methods

The framework of thought used in this study can be described as follows

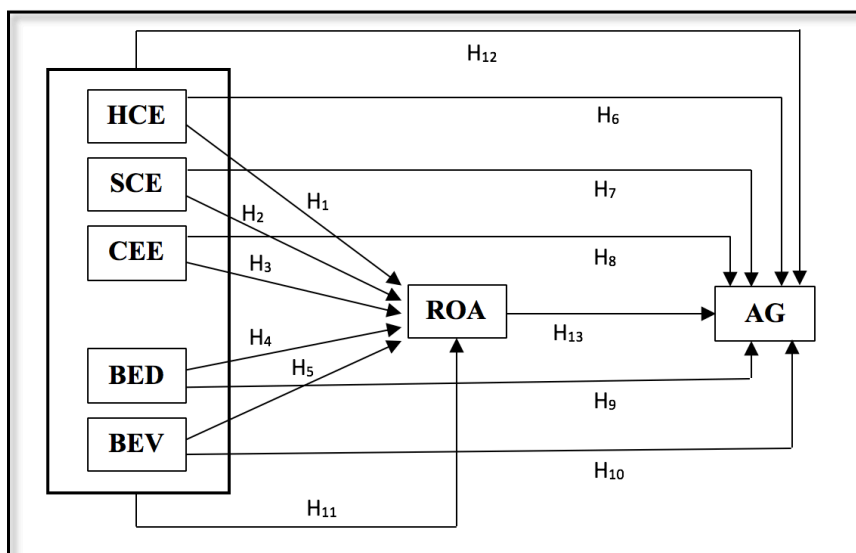

Figure 1. The framework

Based on that framework, the hypothesis of this research is as follows : H1: HCE affects ROA. H2 : SCE affects ROA. H3 : CEE affects ROA. H4 : BED affects ROA. H5 : BEV affects ROA. H6: HCE affects AG. H7 : SCE affects AG. H8 : CEE affects AG. H9 : BED affects AG. H10 : BEV affects AG. H11 : HCE, SCE, CEE, BED,

BEV affects simultaneously on ROA. H12 : HCE, SCE, CEE, BED, BEV affects simultaneously on ROA. H13 : ROA affects AG.

Table 1 : Operational Definitions and variable measurements

No.	Variable	Indicator	Data Source
1.	Human Capital Efficiency (HCE)	$HCE = \frac{Value\ Added\ (VA_i)}{Human\ Capital\ (HC_i)}$	Annual Report
2.	Structure Capital Efficiency (SCE)	$SCE = \frac{Structural\ Capital\ (SC_i)}{Value\ Added\ (VA_i)}$	Annual Report
3.	Capital Employed Efficiency (CEE)	$CEE = \frac{Value\ Added\ (VA_i)}{Capital\ Employed\ (CE_i)}$	Annual Report
4.	Board of Education (BED)	$BED = \frac{education\ level\ of\ directors}{maximum\ level\ of\ education}$	Annual Report
5.	Board of Evaluation (BEV)	$BEV = \frac{total\ attendance\ meeting}{total\ meeting\ x\ directors}$	Annual Report
6.	Return On Asset (ROA)	$ROA = \frac{Net\ Income\ after\ Tax}{Total\ Aset}$	Annual Report
7.	Asset Growth (AG)	$AG = \frac{asset\ addition_n}{Asset\ at\ year_{n-1}} \times 100\%$	Annual Report

Population is a generalization area that consists of objects / subjects that have certain qualities and characteristics that are determined by researchers to be studied and then drawn conclusions (Sugiyono, 2011). The population in this study are all Sharia commercial banks in Indonesia. From this population, criteria were determined in determining the samples to be used in this study. The criteria for determining the sample are as follows:

Table 2 : Sampling criteria

No.	Criteria	Amount
1	All sharia commercial banks, and not including sharia units or Sharia Regional Development Banks.	14
2	All sharia commercial banks in Indonesia, both private and state-owned.	12
3	All sharia commercial banks that have started operating since 2014 to 2018 adjusted to the observation period.	12
	Number of companies that meet the criteria	12

The data used are panel data derived from annual reports from the companies included in the sample with sample duration. The panel data regression model used in this study is to combine cross section data with time series data. Data cross section is the parameters observed and analyzed by the company, while the time series data is the period of observation in the study, which is for a period of 5 years. Thus, the more population taken, and also the wider the time span used as observation, the more panel data obtained.

Panel data regression is a regression that uses observations of one or more variables in a unit continuously for several periods of time (Ratnasari, et. Al, 2014). The general models that will be used in this study are as follows (Dencik; Fitriya, Mohammad, Noor. 2018)

$$Y_{ij} = \mu + \alpha_j + \varepsilon_{ij} \dots\dots\dots(1)$$

With:

- Y_{ij} is the subject of the dependent variable for experiment
- μ is a constant that represents a value that does not depend on the dependent variable for various experimental conditions.
- α_j is the effect of various experimental conditions and random variables
- ε_{ij} is an error term.

From that general equation, this study would use the regression equations as follow:

$$\text{Equation 1 : } ROA = \alpha_{it} + \beta_{1it}.BED_{it} + \beta_{2it}.BEV_{it} + \beta_{3it}.HCE_{it} + \beta_{4it}.SCE_{it} + \beta_{5it}.CEE_{it} \dots\dots (2)$$

$$\text{Equation 2 : } AG = \alpha_{it} + \beta_{1it}.BED_{it} + \beta_{2it}.BEV_{it} + \beta_{3it}.HCE_{it} + \beta_{4it}.SCE_{it} + \beta_{5it}.CEE_{it} \dots\dots (3)$$

$$\text{Equation 3 : } AG = \alpha_{it} + \beta_{1t}.ROA_{it} \dots\dots\dots(4)$$

The data was processed using eviews version 8 software, and description analysis will be carried out first before we did the panel data regression analysis. Determination of the estimation model is done by conducting a chow test, a hausman test and a Lagrange Multiplier test. (Astuti, 2017). Meanwhile, the Lagrange Multiplier test will only be done if the results of the chow test and the Hausman test show different results.

There are 4 classic assumption tests that can be applied in this study. The purpose of this classic assumption test is to provide certainty that the regression equation obtained has accuracy in estimation, is unbiased and consistent. The tests included in the classic assumption test are the normality test, the autocorrelation test, the heterokedasticity test, and the multicollininity test.

In connection with the use of panel data in this study, the classic assumption test was not conducted. According to Gujarati 2012 in Kasmiarno. et. al (2017) classic assumption test is not needed in panel data analysis because panel data can minimize the bias that is most likely to appear in the results of the analysis, giving more information, variations, and degrees of freedom.

Determination of the estimation model is done to determine the best estimation model among the three models, namely the Fixed Effect Model, Common Effect Model, or Random Effect Model. In panel data regression a regression estimation model is used, i.e Common Effect Model (CEM), Fixed Effect Model (FEM) dan Random Effect Model (REM) (Astuti, 2017). And for the last, regression model is done by using the T-test, F-test, and the determination Coefficient R square. The test would use the value is 0.05 or 5%.

3. Result and Discussion

The companies included in the sample in this study were 12 Sharia commercial banks. For the descriptive analysis, the study found :

Table 3 : descriptive analysis

	HCE	SCE	CEE	BED	BEV	ROA	AG
Mean	89.62917	52.01950	17.45150	72.98617	85.92633	-0.293667	29.74133
Median	137.8250	31.86500	20.82000	73.33000	90.65000	0.300000	14.10000
Maximum	369.5000	657.3200	89.08000	85.00000	100.0000	8.020000	1134.870
Minimum	-1181.540	-275.5900	-299.2400	60.00000	14.29000	-16.89000	-48.11000
Std. Dev.	219.8696	110.2893	48.53178	5.393975	14.70048	3.904465	146.2563
Skewness	-3.980396	2.757522	-4.660578	-0.238598	-2.499611	-2.094189	7.364548

Kurtosis	21.53675	18.48374	31.59759	3.661008	11.21073	9.547458	56.19099
Jarque-Bera Probability	1017.464	675.4046	2261.766	1.661616	231.0209	151.0293	7615.569
Sum	5377.750	3121.170	1047.090	4379.170	5155.580	-17.62000	1784.480
Sum Sq. Dev.	2852217.	717659.7	138964.7	1716.603	12750.14	899.4458	1262063.
Observations	60	60	60	60	60	60	60

T-Test

T-Test conducted to determine the partially significant effect of each independent variable whether it affects the dependent variable. Hypothesis for this T-Test are : Ho : is no effect of independent variables on dependent variable. Ha : there is influence of the independent variables on dependent variable.

Decision criteria is: if the probability value of the independent variable is smaller than 0.05 then there is the influence of the independent variable on the dependent variable. If the probability value of the independent variable is greater than 0.05 then there is no effect of the independent variable on the dependent variable.

Table 4 : T-Test

No.	Variable		T Test
Equation 1			
$ROA = \alpha_{it} + \beta_{1it}.BED_{it} + \beta_{2it}.BEV_{it} + \beta_{3it}.HCE_{it} + \beta_{4it}.SCE_{it} + \beta_{5it}.CEE_{it}$			
1.	HCE	0.0000	Ho is rejected. HCE has a significant effect on ROA
2.	SCE	0.3203	Ho accepted. SCE does not have a significant effect on ROA
3.	CEE	0.2206	Ho accepted. CEE does not have a significant effect on ROA
4.	BED	0.7656	Ho accepted. BED does not have a significant effect on ROA
5.	BEV	0.2728	Ho accepted. BEV does not have a significant effect on ROA
Equation 2			
$AG = \alpha_{it} + \beta_{1it}.BED_{it} + \beta_{2it}.BEV_{it} + \beta_{3it}.HCE_{it} + \beta_{4it}.SCE_{it} + \beta_{5it}.CEE_{it}$			
1.	HCE	0.0116	Ho is rejected. HCE have a significant effect on AG
2.	SCE	0.4704	Ho accepted. SCE does not have a significant effect on AG
3.	CEE	0.9889	Ho accepted. CEE does not have a significant effect on AG
4.	BED	0.3500	Ho accepted. BED does not have a significant effect on AG
5.	BEV	0.8757	Ho accepted. BEV does not have a significant effect on AG
Equation 3			
$AG = \alpha_{it} + \beta_{1it}.ROA_{it}$			
1.	ROA	0.0000	Ho is rejected. ROA has a significant effect on AG

F-Test

This test is a test to find out the significance level of all independent variables simultaneously on the dependent variable. Hypothesis for this test are : Ho : is no effect of independent variables on dependent variable. Ha : there is influence of the independent variables on dependent variable. For each equation, independent variables are BED, BEV, HCE, SCE, CEE. For equation 1, dependent variable is ROA. For equation 2, dependent variable is AG. Decision criteria is: if the probability value of the F statistic is smaller than 0.05 then there is the influence of the independent variable on the dependent variable. If the probability value of the F statistic is greater than 0.05 then there is no effect of the independent variable on the dependent variable.

Table 5 : F-Test

No.	Equation	F Test
1.	$ROA = \alpha_{it} + \beta_{1it}.BED_{it} + \beta_{2it}.BEV_{it} + \beta_{3it}.HCE_{it} + \beta_{4it}.SCE_{it} + \beta_{5it}.CEE_{it}$	0.000000 Ho is rejected. BED, BEV, HCE, SCE, CEE simultaneously influence ROA
2.	$AG = \alpha_{it} + \beta_{1it}.BED_{it} + \beta_{2it}.BEV_{it} + \beta_{3it}.HCE_{it} + \beta_{4it}.SCE_{it} + \beta_{5it}.CEE_{it}$	0.020743 Ho is rejected. BED, BEV, HCE, SCE, CEE simultaneously influence AG

Determination coefficient R²

This test is used to find out how much the proportion of dependent variation can be influenced by the independent variable. This test measures how far the independent variable explains the variation of the dependent variable.

The result of this test are :

Table 6 : Determination coefficient R²

No.	Equation	Coefficient of Determination	
1.	$ROA = \alpha_{it} + \beta_{1it}.BED_{it} + \beta_{2it}.BEV_{it} + \beta_{3it}.HCE_{it} + \beta_{4it}.SCE_{it} + \beta_{5it}.CEE_{it}$	R ¹ ²	0.9366661
2.	$AG = \alpha_{it} + \beta_{1it}.BED_{it} + \beta_{2it}.BEV_{it} + \beta_{3it}.HCE_{it} + \beta_{4it}.SCE_{it} + \beta_{5it}.CEE_{it}$	R ² ²	0.213211
3.	$AG = \alpha_{it} + \beta_{1it}.ROA_{it}$	R ³ ²	0.346701
		$R_1^2 + R_3^2 > R_2^2$ 0.9366661 + 0.346701 > 0.213211	

The final equation for each are :

1) Equation 1 :

From Equation 1, the study found that the best model that we can do is the Fixed Effect Model (FEM). The final equation 1, based on the result of the study is $ROA = 1.026998 + 0.011812 HCE - 0.001600 SCE + 0.006697 CEE - 0.014393 BED - 0.015857 BEV$.

From them, study analysis the effect from the independent variable to the ROA, found that only HCE is have the significant partial effect to the ROA. Besides that, for the simultaneous effect, study found that all independent variable have significant effect to the ROA. The contribution of all independent variables to ROA was 93.66661%. The rest comes from other variables not examined in this study.

2) Equation 2 :

From Equation 2, the study found that the best model that we can do is the Common Effect Model (CEM). The final equation 2, based on the result of the study is $AG = 37.29616 + 0.035754 HCE - 0.0155505 SCE - 0.000896 CEE - 0.421894 BED + 0.024787 BEV$

From them, study analysis the effect from the independent variable to the AG, found that only HCE is have the significant partial effect to the AG. Besides that, for the simultaneous effect, study found that all independent variable have significant effect to the AG. The contribution of all independent variables to AG was 21.3211%. The rest comes from other variables not examined in this study.

3) Equation 3 :

From Equation 3, the study found that the best model that we can do is the Common Effect Model (CEM). The final equation 3, based on the result of the study is $AG = 11.83246 + 2.780300 ROA$.

From them, study analysis the effect from the ROA to the AG, found that ROA have the significant effect to the AG. ROA's contribution to AG was 34.6701%. The rest comes from other variables not examined in this study.

Discussions

- 1) HCE has a statistically significant effect on ROA. This is indicated by the probability value of HCE against ROA is 0.0000 where the value is less than 0.05.
This shows that the quality of human resources, and all costs incurred in relation to human resources have a significant impact on increasing ROA.
From the final formula obtained for this equation 1, it is found that each increase of 1 unit of HCE will cause an increase in ROA of 0.011812 units. This means that the increase in costs given to employees in order to increase the ability of employees will be able to increase the achievement of company ROA. The ability of employees to do all their activities determines the company's operational activities that ultimately can increase the achievement of ROA.
These results are in line with the results of research from Dwipayani. et. al (2014) which states that Human Capital Efficiency does not have a significant negative effect on Return on Assets (ROA). This result is not in line with the results of research from Ciptaningsih (2013) which states that the efficiency of Human Resources owned by the company apparently does not have a significant influence on the company's current financial performance. Another study by Aritonang (2016) found that the HCE component did not have a positive and significant influence on the company's financial performance in the next 1 year.
- 2) SCE has a statistically negative and not significant effect on ROA. This is indicated by the probability value of SCE to ROA is 0.3203. This number is greater than 0.05 so it can be interpreted that the SCE variable has no significant effect on ROA and AG.
From the final formula obtained for this equation 1, it is found that each increase of 1 unit of SCE will cause a decrease in ROA of 0.001600 units. This means that is all the efforts of the company in improving corporate culture, the company system will have the effect of reducing corporate profits. Improving the company's culture cannot necessarily increase profits and the company's ROA ratio at the same time. Corporate culture can improve employee work efficiency but not in a short time.
This result is in line with the results from Ciptaningsih (2013) study which states that even though the company has good efficiency of its structural capital does not necessarily indicate the prospect of improved financial performance in the future.
But these results are not in line with the results of research from Dwipayani. et. al (2014) which states that Intellectual Capital, Structural Capital Efficiency, and Capital Employed Efficiency have a significant positive effect on Return on Assets (ROA).
Other studies also with results that are not in line, namely by Aritonang (2016) with the results that the SCE component is positive and significant effect on the company's financial performance.
- 3) CEE has a statistically positive and not significant effect on ROA. This is indicated by the probability value of CEE to the profitability of the company represented by the variable ROA is 0.2206. This number is greater than 0.05 so it can be interpreted that the CEE variable has no significant effect on ROA.
From the final formula obtained for this equation 1, it is found that each increase of 1 unit of CEE will cause an increase in ROA of 0.006697 units. This means that the greater the company's relationships and relationships with other partners, the greater the revenue that will be obtained by the company, and ultimately can increase the company's ROA. The company is able to get more accurate information from partners related to the company's efforts to obtain greater profits.
This research is not in line with the results of research by Ciptaningsih (2013), which states that the results of the analysis note that what has proven to consistently affect the company's financial performance is the CEE (Capital Employed Efficiency) variable. Other studies are also not in line with the results of Dwipayani. et. al (2014) which states that Intellectual Capital, Structural Capital Efficiency, and Capital Employed Efficiency have a significant positive effect on Return on Assets (ROA). Another research that is not in line is the research by Aritonang (2016) which states that the CEE component has a positive and significant effect on the company's financial performance in the future.

- 4) BED has a statistically negative and not significant effect on ROA. This is indicated by the probability value of the BED against ROA is 0.7656. This number is greater than 0.05 so it can be interpreted that the CEE variable has no significant effect on ROA.
From the final formula obtained for this equation 1, it is found that each increase of 1 unit of BED will cause a decrease in ROA of 0.014393 units. This means that the greater the age of directors, the directors are less brave in making decisions to increase company revenue. Decisions taken by directors are only normative and there are not many breakthroughs that dare to be taken by directors in terms of increasing company revenue. These results are not in line with the results of research by Erlim. et. al (2017) which states that CEO education level has a positive effect on company performance as measured by Tobin's Q. Tobin's Q is an evaluation of the company's value and its effect on the market or market.
- 5) BEV has a statistically negative and not significant effect on ROA. This is indicated by the probability value of BEV against ROA is 0.2728. This figure is greater than 0.05 so it can be interpreted that the BEV variable has no significant effect on ROA. This insignificant effect is that the number of directors' attendance at board of directors meetings does not significantly affect the achievement of company ROA.
From the final formula obtained for this equation 1, it was found that each increase of 1 unit of BEV will cause a decrease in ROA of 0.015857 units. This means that the more directors' meetings are held, the higher the attendance of the directors can cause a decrease in company ROA. Decisions that should be taken by directors in terms of routine operational problems are constrained because of the routine in the directors meeting that must be made.
- 6) HCE statistically has a positive and significant effect on AG. This is indicated by the probability value of HCE against AG is 0.0116 where the value is less than 0.05.
From the final formula obtained for equation 2, it is found that each increase of 1 unit of HCE will cause an increase in AG of 0.035754 units. This positive influence shows that the higher the company in spending costs to improve the ability of its employees in carrying out operational processes in the company will have a positive impact on increasing company assets.
However, these results are not in line with the results of research from Ciptaningsih (2013) which states that the efficiency of Human Resources owned by the company apparently did not have a significant effect on the company's current financial performance.
This shows that the quality of human resources, and all costs incurred in relation to human resources have a significant impact on increasing AG.
- 7) SCE has a statistically negative and not significant effect on AG. This is indicated by the probability value of SCE against AG is 0.4704. This number is greater than 0.05 so it can be interpreted that the SCE variable has no significant effect on AG.
From the final formula obtained for equation 2, it is found that each increase of 1 unit of SCE will cause a decrease in AG of 0.0155505 units. This negative influence shows that the higher the company develops corporate culture in order to develop optimal company performance, the lower the increase in assets by the company. This can be interpreted that the company is still in the stage of developing a corporate culture and requires capital to improve the quality of human resources through various efforts. The development of a company's performance can not directly provide immediate and rapid results to increase company assets.
This result is in line with the results of a study by Ciptaningsih (2013) which states that even though a company has good efficiency of its structural capital does not necessarily indicate the prospect of improved financial performance in the future.
- 8) CEE has a statistically negative and not significant effect on AG. This is indicated by the probability value of CEE on the AG variable is 0.9889. Both of these numbers are greater than 0.05 so it can be interpreted that the CEE variable has no significant effect on AG.
From the final formula obtained for equation 2, it is found that each increase of 1 unit of CEE will cause a decrease in AG of 0,000896 units. This negative influence shows that the higher the relationship and the company's relationship with related partners, the lower the increase in company assets. Companies will be more encouraged to increase the availability of operational materials compared to the company's needs to

develop assets.

These results are not in line with the results of the research by Ciptaningsih (2013), which states that the results of the analysis note that what is proven to consistently affect the company's financial performance is the variable CEE (Capital Employed Efficiency).

- 9) BED has a statistically negative and not significant effect on AG. This is indicated by the probability value of the BED against AG is 0.3500. This number is greater than 0.05 so it can be interpreted that the CEE variable has no significant effect on AG.
From the final formula obtained for this equation 2, it is found that each increase of 1 unit of BED will cause a decrease in AG of 0.421894 units. This negative influence shows that the higher the age of the board of directors, the more reluctant to develop their assets. The orientation of the board of directors towards the direction of the company is to increase profits so that it increases so that it increases the value of the company. These results are not in line with the results of research by Erlim. et. al (2017) which states that CEO education level has a positive effect on company performance as measured by Tobin's Q. Tobin's Q is an evaluation of the company's value and its effect on the market or market.
- 10) BEV has a statistically positive and not significant effect on AG. This is indicated by the probability value of BEV against AG is 0.8757. This number is greater than 0.05 so it can be interpreted that the BEV variable has no significant effect on AG.
From the final formula obtained for this equation 2, it is found that each increase of 1 unit of BEV will cause an increase in AG of 0.024787 units. This effect is not significant because the increase in AG obtained is not proportional to the effort to get a 1 unit increase in BEV.
- 11) Statistically, independent variables (HCE, SCE, CEE, BED, BEV) have a significant effect on ROA. This is indicated by the probability value of 0.000000 which is less than 0.05 so that all independent variables have a significant simultaneous effect on ROA.
The influence of all independent variables on the ROA variable based on the coefficient of determination obtained a value of 93.6661%. The rest, is the influence of other variables outside the independent variables examined in this study. Efforts to improve all independent variables in this study can significantly improve the achievement of company ROA.
This result is in line with the results of research by Erlim. et. al (2017) which states that the Intellectual Capital variable measured by VAIC obtained has a significant positive effect on profitability of ROA.
- 12) Statistically, independent variables (HCE, SCE, CEE, BED, BEV) have a significant effect on AG. This is indicated by the probability value of 0.020743 which is less than 0.05 so that all independent variables have a significant simultaneous effect on AG.
The influence of all independent variables on the AG variable based on the coefficient of determination obtained a value of 21.3211%. The rest, is the influence of other variables outside the independent variables examined in this study. Although it has a significant effect, all independent variables only have an effect of 21.3211% on the increase in assets. This means that the increase in assets is also much influenced by other factors such as policy and direction of the company that is not examined in this study.
- 13) ROA has a statistically significant effect on AG. This is indicated by the probability value of ROA against AG that is 0.0000. This number is smaller than 0.05 so it can be interpreted that the ROA variable has a significant effect on AG.
From the final formula obtained, namely $AG = 11.83246 + 2.780300 ROA$, it can be interpreted that an increase in ROA by 1 unit can increase AG by 2.780300 units.
Increase in Asset or Asset Growth is very much influenced by the company's return on assets or ROA. The return of assets obtained from the net profit of an Islamic bank company will make that asset growth also accelerate.
ROA is a ratio of return on assets owned by a company from the amount of profit achieved. Companies that have high ROA values can have opportunities to develop their assets, and vice versa if the value of ROA is small then the possibility for asset development is also getting smaller and the company will focus more on

the company's operations.

4. Conclusion and Suggestions

The conclusions of this study are as follows:

- 1) There is partial positive significant influence from Human Capital Efficiency to Return On Asset
- 2) There is partial negative and not significant influence from Structural Capital Efficiency to Return On Asset
- 3) There is partial positive and not significant influence from Capital Employed Efficiency to Return On Asset
- 4) There is partial negative and not significant influence from Board of Education to Return On Asset
- 5) There is partial negative and not significant influence from Board of Evaluation to Return On Asset
- 6) There is partial positive and significant influence from Human Capital Efficiency to Asset Growth
- 7) There is partial negative and not significant influence from Structural Capital Efficiency to Asset Growth
- 8) There is partial negative and not significant influence from Capital Employed Efficiency to Asset Growth
- 9) There is partial negative and not significant influence from Board of Education to Asset Growth
- 10) There is partial positive and not significant influence from Board of Evaluation to Asset Growth
- 11) There are simultaneous significant influence from independent variables to Return on Asset.
- 12) There are simultaneous significant influence from independent variables to Asset Growth.
- 13) There is positive and significant influence from Return on Asset to Asset Growth

The Suggestions from this study are :

- 1) For further research, it should be able to see other aspects of corporate governance (such as the number of committee members under the commissioners, the number of commissioners, the education of the commissioners) and their influence on ROA and AG in Islamic commercial bank companies.
- 2) For the further research, it should add a dummy variable for islamic commercial banks which are subsidiaries of commercial banks. Are the commercial banks as the holding company give effect to the policy of the islamic banks.

References

- Aritonang, Qaharuna Agasa Setyadam. Muharam, Harjum. Sugiono. (2016). Effect of Intellectual Capital on Financial Performance. *business strategy journal*. 25(1) pp 1 - 17.
- Astuti, Wahyu Indri. Ratnasari, Vita. Wibowo, Wahyu. (2017). Analysis of Factors affecting the Open Unemployment rate in East Java Province Using Panel Data Regression. *Saint Journal and Art*. 6(1). pp 150-156.
- Choong, Kwee Keong. (2008). Intellectual Capital : Definitions, Categorization and reporting models. *Journal of Intellectual Capital*. 9(4). pp 609 - 638. DOI : <https://doi.org/10.1108/14691930810913186>
- Ciptaningsih, Tri. (2013). Test of the Effect of Intellectual Capital on the Financial Performance of SOEs Going Public in Indonesia. *Journal of Technology Management*. 12(3). dec. 2013.
- Dencik, Abdul Basyith. Yahya, Fitriya Fauzi. Yoesoef, Mohammad Idris. Salim, M. Noor (2018). *Multivariate Statistics Analysis of Anova, Manova, Ancova, Repeated Measured with Excel and SPSS Applications*. First Edition, Oktober 2018. Publishers: Rajawali Pers. Depok. West Java. Indonesia.
- Dwipayani, Chrisnatty Chandra. Prastiwi, Andri. (2014). The Effect of Intellectual Capital on Profitability and Market Performance. *Diponegoro Journal of Accounting*. 3(3). 2014. Pp.201-209.
- Erlim, Kevin Wiyarta. Juliana, Rita. (2017). Effects of Education Level and CEO Education Specialization on Company Performance in Indonesia. *Maranatha Management Journal*. 16(2). Pp 133 – 212.
- Umaiyah, Erwin. Salim, M. Noor. (2017). Financial Ratios, Company Size, Capital Structure and Its Impacts on the Value of Non-Banking Companies in the LQ-45 Category. *Indicator Journal*. 2(3). Pp 120 – 135.
- S.W., Indah Fajarini. Firmansyah, Riza. (2012). The Effect of Intellectual Capital on Company Financial Performance (Empirical Study of LQ-45 Companies). *Journal of accounting dynamics*. 4(1). pp 1-12
- Farida, Yustiati Nur. Prasetyo, Yuli. Heriyanti. Eliada. (2010). The Influence of the Implementation of Corporate Governance on the Income of Earning Management in Assessing Financial Performance in Banking Companies in Indonesia. *Business and Accounting journals*. 12(2). pp 69-81.
- Kartika, Martha. Hatane, Saarce Alsye. (2013). The Effect of Intellectual Capital on the Profitability of Banking Companies Listed on the Indonesia Stock Exchange in 2007-2011. *Business Accounting Review*, 1(2). pp. 14-22.

- Kasmiarno, Kurnia Sari. Mintaroem, Karjadi. (2017). Analysis of the Effect of Economic Indicators and Sharia Banking Performance on Manpower Absorption in Sharia Banking in Indonesia 2008 – 2014. *Journal of Sharia Theory and Applied Economics*. 4(1). pp. 14-26.
- Kasmir, S.E (2010). *Introduction to Financial Management*. Second edition. Kencana. Jakarta.
- Khafid, Muhammad. (2012). Effect of Corporate Governance and Ownership Structure on Profit Persistence. *Journal of accounting dynamics*. 4(2). pp. 139-148.
- Kurniasih, Augustina. Helianton. (2016). Intellectual Capital of a BUMN Open Bank and Its Impact on Company Performance. *MIX Scientific Management Journal*. 6(2). pp. 195-212.
- Mulyana, Bambang. Rini, Rahmatika. (2017). The Effect of Solvency, Profitability, Company Size and Stock Beta on the Value of the Company and Its Impact on the Returns of Companies in the Automotive Sub Sector and its Components listed on the Indonesia Stock Exchange for the Period of 2020-2016. *Journal indicator*. 1(3). pp. 17-30.
- Nuswandari, Cahyani. (2009). The Effect of Corporate Governance Perception Index on Company Performance on Companies Listed on the Jakarta Stock Exchange. *Journal of business and economics (JBE)*. 16(2). pp 70-84.
- Pulic, Ante. (1998). *“Measuring the Performance of Intellectual Potential in Knowledge Economy”*.
_____. (2008). *“The Principles of Intellectual Capital Efficiency - A Brief Description*. Croatian Intellectual Capital Center, Zagreb. 76.
- Raharjo, Eko. (2007). Agency Theory and Stewardship Theory in Accounting Perspectives”. *economic focus*. 2(1). pp. 37-46.
- Ratnasari, Ni Putu Anik Mas. Kencana, I Putu Eka Nila. Gandhiadi, G. K. (2014). Application of Panel Data Regression with Fixed Effect Model Approach. *Mathematics e-journal*. 3(1). pp 1-7.
- Salim, Selvi Meliza. Karyawati, Golrida. (2013). “Effect of Intellectual Capital on financial performance”. *Journal of Business and Entrepreneurship* 1(2). Pp. 74 – 91.
- Salim, M. Noor. Wahyuni, Evilin Sri. 2019. The Effect of Internal, External Factors On Corporate Performance and Its Impact On Corporate Values in Indonesia Manufacturing Companies in The Automotive Sub Sector and Its Components in 2008-2017. *International Journal of Engineering Technologies and Management Research*. Volume 6 (Iss. 6). pp 101-115. DOI: 10.5281/zenodo.3266140
- Santoso, Agus. (2017). Effect of Good Corporate Governance on firm value with financial performance as an intervening variable. *Proceedings Seminar Nasional and Call For Paper Economic and Business*. Jember, Oct 27-28 2017. Pp. 67 - 77.
- Suroso, Sugeng. Widyastuti, Tri. Salim, M. Noor. Setyawati, Irma (2017). Intellectual Capital and Corporate Governance in Financial Performance Indonesia Islamic Banking. *International Journal of Economics and Financial Issues*. 2017. 7(4). pp 96-103.
- Sugiyono, Prof. (2011). *“Quantitative, Qualitative, and R&D Research Methods”*. Bandung. Alfabeta, Bandung.
- Syafrida, Ida. Abror. Ahmad. (2011). Factors That Influence Sharia Banking Asset Growth in Indonesia. *Journal of economics and business*. 10(1). pp 19-24.
- Tandelilin, Eduardus. (2010). *Portfolio and Investment Theories and Applications*. Kanisius. Yogyakarta.
- Tertius, Melia Agustina. Christiawan, Yulius Jogi. (2015). The Effect of Good Corporate Governance on Company performance in the Financial Sector. *Business Accounting Review*. 3(1). pp. 223-232.
- Zubair, Muhammad Kamal. (2008). Growth Acceleration of Islamic Banks in Indonesia. *Millah*. 2008. 8(1). pp 1-16. DOI: <https://doi.org/10.20885/millah.vol8.iss1.art1>



Assessment of Relationship Between Personal Attitude and the Entrepreneurship Intention Among Students in Federal Polytechnic in Northern Nigeria

S. I. Attahiru¹, M. A. Olaoye², B. Isyaku³, M. Abubakar⁴

^{1,2,3,4} Kaduna Polytechnic, Kaduna State. Nigeria

Abstract

As presently conceptualized, entrepreneurship education is implemented in Nigerian tertiary educational institutions to equip the undergraduate with business skills that would make them self-employed rather than job seekers, at graduation. The assessed relationship between personal attitude and the entrepreneurship intention among students in Federal Polytechnic in Northern Nigeria This study was guided by a hypothesis. The study adopted causal comparative (Ex-Post-factor) design. The population of the study was made up of all the students in federal polytechnics in Northern Nigeria. Simple random sampling method named Dip-hand sampling method was used to select the sampled states for the study while proportional sampling method was used in selecting respondents from each school in the selected federal polytechnics, while the sample size was 1,135. The instrument for the study was researcher's developed Likert-type questionnaire named influence of entrepreneur courses in the development of students' career opportunities in Universities Nigeria. Split-half reliability was used to test the reliability of the instrument with reliability index of 0.79. PPMC was used to test hypothesis six at 0.05 alpha level of significance. It was concluded that students in Federal Polytechnic in Northern Nigeria have personal attitude towards entrepreneurship intention. It was recommended that Government should provide loans to encourage small and medium scale enterprises.

Keywords: Personal Attitude, The Entrepreneurship Intention, Federal Polytechnic

Introduction

The introduction of entrepreneurship education by the Federal Government of Nigeria represents one of the concrete efforts to stem the tide of rising graduate unemployment in the country. Writing on entrepreneurship education, Anyanwu, Obichere and Ossai-Onah (2012) explained that it is the process of inculcating the knowledge of creating value by pooling together a unique package of resources to exploit an opportunity. As presently conceptualized, entrepreneurship education is implemented in Nigerian tertiary educational institutions to equip the undergraduate with business skills that would make them self-employed rather than job seekers, at graduation. Based on the understanding that entrepreneurship education will free the enterprising and innovative spirit of the beneficiaries', the Federal Government of Nigeria has approved its incorporation into the curriculum of her higher

education institutions. The National Universities Commission (NUC) and National Board for Technical Education (NBTE), in line with their mandates as regulators of universities and polytechnics programmes, insist that students must take and pass specific entrepreneurship courses before graduation.

Another study from Sri Lanka, (kumara, 2012) has further revealed that students who have received entrepreneurial education often develop positive attitudes and beliefs towards self-employment and entrepreneurship intention to a large extent.

In recent times, there has been increasing global concern over the continuously expanded rates of unemployment around the world, particularly in most developing countries, where the youth have been identified as the most affected groups. As a result, various governmental and non-governmental organizations have initiated policies through support agencies such as National Directorate for Employment (NDE), the National Poverty Eradication Programme (NAPEP), Small Medium Enterprises Development Agency (SMEDAN), National Office for Technology Acquisition and Promotion (NOTAP), Raw Materials & Development Council (RMRDC) among others to address the problems of unemployment among Nigerian citizens (Emmanuel, 2012).

Hypothesis

H₁. There is no relationship between personal attitude and the entrepreneurship intention among students in Federal Polytechnic in Northern Nigeria.

Methodology

In this study, the researcher adopted a causal-comparative (Ex-Post-factor) design, since the study was an existing identified phenomenon. According to Kerlinger (2000), the Ex-Post-Factor design is a design in which the investigation of the variable is done retrospectively whether they have occurred in natural cause of the event. Because no variables are manipulated, an independent variable is the one in which the cause and effect are wanted. Ofo (1994), also supported that the causal-comparative or Ex-Post-Facto research attempts to determine the cause-and-effect relationships by examining conditions and tracing back the information and available data for probable causal factors. She furthered that Causal-comparative studies start with an identified effect and proceeds to find possible causes.

The population of this study is made up of all the students in federal polytechnics in Northern Nigeria. A simple random sampling method named Dip-hand sampling method by Adegboye (2001) was used to select the sampled states for the study while the proportional sampling method was used in selecting respondents from each school in the selected federal polytechnics. The procedure was used as follow:

- i. The Northern Nigeria is made up of 19 states that are divided into 3 geo-political zones, namely:- North Central (6 states), North East (6 states) and North West (7 states). Three students were assigned to select sampled states. Each student represented each zone and the name of each state was written on pieces of paper, put in a container for the student assigned to the zone to pick. Students who represented North Central and North East picked two times each, that is, Federal Polytechnic, Damaturu and Federal Polytechnic, Bauchi for North East and Federal Polytechnic, Bida and Federal Polytechnic, kaffi, for North Central while student assigned to North West picked three times. Two states were selected from North Central and two states from North East while three states were selected from North West because of additional differences of one state. That is, Federal Polytechnic, Kaura Namuda; Federal Polytechnic, Kauzare; and Kaduna Polytechnic, Kaduna. The picked states were used as sample Federal Polytechnic and a total of seven Federal Polytechnic were used.
- ii. Proportional sampling method was used in selecting respondents from the seven states and respondents were selected from the four faculties. This summed of 1,135 questionnaires will be distributed to the seven sampled federal universities.
- iii. Systematic sampling procedure will be used to assign questionnaires to respondents.

The instrument for the study was researcher's developed Likert-type questionnaire named influence of entrepreneur courses in the development of students' career opportunities in Universities Nigeria. This was divided into two (2) sections. Section "A" demanded data on demographic characteristics of the respondents while section "B" requested information on the influence of entrepreneur courses in the development of students' career opportunities in polytechnics Nigeria. Responses to the statements are Strongly Agree (SA), Agree (A), Undecided (U), Disagree (D) and Strongly Disagree (SD).

The responses for items in section B were rated as follows:

Degree of response		Points
Strongly Agree	(SA)	5
Agree	(A)	4
Undecided	(U)	3
Disagree	(D)	2
Strongly Disagree	(SD)	1

The instrument was validated by researcher's supervisors, experts entrepreneurship and business and also specialists in test and measurement to ensure face and content validity of the instrument. Corrections, suggestions and observations were incorporated in the final draft of the questionnaire, and subsequently approved by the supervisors before it was administered. To ascertain the reliability of the research instrument, the validated questionnaire will be subjected to pilot study using sixty (60) students of polytechnics which are not part of the study, these participants were not part of the study and twenty four statements formulated from the variables were tested. Split-half method was used to examine the reliability of the instrument. Ofo (1994) stated that the split – half reliability is a type of internal consistency reliability. In its case only one test is administered and it eliminates measurement errors such as differences in testing conditions which could easily affect the test-retest reliability. The reliability coefficient was 0.79, which make the instrument reliable for the study.

To conduct the administration of the research instrument, an introductory letter will be collected from The Coordinator, Research, Innovation and Technology Transfer Office, Kaduna Polytechnic, Kaduna. The Researcher also requested the permission of the sampled federal polytechnics before questionnaires will be administered to the respondents. The researcher will go round the sampled states to administer the instrument with the help of five (5) trained research assistants in each Polytechnic, who interpreted the questions to the respondents in simple language that do not influence their responses. Person's Product Moment Correlation (PPMC) was used to test hypothesis six at 0.05 alpha level of significance.

Result

There is no relationship between personal attitude and the entrepreneurship intention.

Table 1: Summary of the person product moment correlation on the relationship between personal attitude and the entrepreneurship intention

Variable	N	X	Sd	df	r	prob
Entrepreneurship Intention	1,135	12.44	1.71	1,133	.88	0.002
Personal Attitude	1,135	12.61	1.40			

r = .88; df= 1,133; (P<0.05)

The table above reveals that mean (x) score for entrepreneurship intention is 12.44, while that of the personal attitude is 12.61, the standard deviation (SD) for entrepreneurship intention is 1.71 and the personal attitude is 1.40. The statistical computation shows that a very strong relationship exist with $df=1,133$; $r=0.88$ ($P<0.05$) The null hypothesis stated was rejected on the account that significant relationship exist. There is a relationship between personal attitude and the entrepreneurship intention.

Discussion

Relationship exists between personal attitude and the entrepreneurship intention. This is in-line with Christina (2017), who studied Attitude, Subjective Norms, Perceived Behavior, Entrepreneurship Education and Self-efficacy toward Entrepreneurial Intention University Student in Indonesia. Based on the hypothesis testing used the F test obtained F-count value of 22.770 with a significant level of 00001. The results showed that the variable attitudes, subjective norms and behavioral control together a significant effect on variable university student entrepreneurship intentions. It is also agreed with the study of Dinc Sait and Budic Semira (2016), who studied Impact of Personal Attitude, Subjective Norm, and Perceived Behavioural Control on Entrepreneurial Intentions of Women. The result of their study showed that personal attitude significantly and positively influenced Entrepreneurial Intentions of Women. This means that women who have good overall perceptions of the concept of entrepreneurship are more likely to have entrepreneurial intentions, or more precisely, to start companies one day. This is agreed with the study of Benachenhou Mohammed and Omar, (2017) that conducted research on Influence of attitude, subjective norms and perceived behavior Control on entrepreneurial intention. The findings of their study have shown that students' attitudes towards entrepreneurship and subjective norms, have a significant effect on behavioral intentions to entrepreneurship. On the other hand, perceived behavioral control had no significant effect. It is also consistent with the study of Norziani Dahalan, Mastura Jaafar, and Siti Asma' Mohd Rosdi (2015) who conducted research on attitude and entrepreneurial Intention among rural Community. The findings of the study showed that both attitude (attitude toward money, attitude toward start-up) influence entrepreneurial intention. The relationship between attitude toward start-up and entrepreneurial intention was mediated by opportunity recognition.

Recommendation

Based on the findings of this study, the following recommendations were made:

1. Polytechnic should organize and encourage students to attend entrepreneurial competitions and join workshops on entrepreneurship.
2. The government should provide loans to encourage small and medium scale enterprises among students.

References

- Anyanwu I. L., (2006). Practical Tips for Economic Empowerment and Survival. Nsukka: AP Express.
- Benachenhou, S.; Mohammed, A. F. and Omar, B. D. (2017). The Influence of Attitude, Subjective Norms and Perceived Behavior Control on Entrepreneurial Intentions: Case of Algerian Students; American Journal of Economics, 7(6): 274-282 DOI: 10.5923/j.economics.20170706.02
- Christina W, U, (2017). Attitude, Subjective Norms, Perceived Behavior, Entrepreneurship Education and Self-efficacy toward Entrepreneurial Intention University Student in Indonesia: European Research Studies Journal Volume XX, Issue 2A, 2017 pp. 475-495'
- Dinc M. Sait and Budic Semira (2016). Impact of Personal Attitude, Subjective Norm, and Perceived Behavioural Control on Entrepreneurial Intentions of Women: Eurasian Journal of Business and Economics, 9 (17), 23-35.
- Emmanuel, O. N (2011). *Entrepreneurship Education in the University in the Eastern Nigeria; Implications for Higher Education Administration* Unpublished PhD dissertation, University of Port-Harcourt.
- Kumara, S. (2012). UNDERGRADUATES' INTENTION TOWARDS ENTREPRENEURSHIP: EMPIRICAL EVIDENCE FROM SRI LANKA. Journal of Enterprising Culture, 20(1).
- Norziani, D. Mastura, J. and Siti Asma' M. R. (2015). Attitude and Entrepreneurial Intention among Rural Community: The Mediating Role Of Entrepreneurial Opportunity Recognition; SHS Web of Conferences, 0100 (2015).
- Nwabuana, E.C (2004). Information Technology (IT) and Enhancement of Entrepreneurship Education in Secretarial Studies Programme in Polytechnics in Nigeria. A Paper



An Empirical Analysis on Liquidity Management of Commercial Banks in Bangladesh: A Comparative Study Between State-Owned and Private Commercial Banks

Raad Mozib Lalon¹, Nadia Naher²

¹ Department of Banking and Insurance, University of Dhaka, Dhaka, Bangladesh-1000. Email: raadmazib@du.ac.bd

² Department of Banking and Insurance, University of Dhaka, Dhaka, Bangladesh-1000. Email: mozib.banking@gmail.com

Abstract

This study attempts to analyze and compare the liquidity position of major ten private commercial banks and major five state own commercial banks in Bangladesh. In Bangladesh where the conventional banks require maintaining 18% of their deposits as Statutory Liquidity Requirement (SLR) there will be an impact on liquidity of such a ratio. As we know, the number of state-owned banks in Bangladesh is 6 where as the number for private commercial banks is 40 with more new banks to join the numbers. For this research, a random sample of 10 banks from Private commercial banks and 5 state-own banks are taken, the individual liquidity risk ratio, D/E ratio, I/A ratio, bank size, liquidity asset and ROE is tracked. The variables as a whole in F-test are found to be significant with a 5% AND 10% significance level. Individually all the variables in both sectors of banking are found to be significant except for Liquidity risk in state-owned banking.

Keywords: D/E ratio, I/A ratio, ROA, SCBs, PCBs

1. Introduction

Bank lending finances investments in relatively illiquid assets, but it funds its loans with mostly short term liabilities. Thus one of the main challenges to a bank is ensuring its own liquidity under all reasonable conditions. The degree of liquidity depends upon the relationship between a company's cash assets plus those assets which can be quickly turned into cash, and the liabilities awaiting payments could be met immediately. The liquidity and the Investments are two corners opposite to each other. If more earning is required more and more investment is to be made which may result into less degree of liquidity, which may result, on account of not fulfilling the commitments, into penalties/high rate of interests or other types of losses. According to the daily star news, 2018 there are many types of risks which are involving in all banks due to their financial crises. In daily business transactions, banks are facing some risk which caused by their activities. There will be no bank if there is no braveness to take risk. There are several risks that must be considered by banks, for example: market risk,

operational risk, legal risk, compliance risk, credit risk, and liquidity risk. One of that above risks one crucial risk is liquidity risk that comes from the mismatch timing between cash inflow and cash outflow. This lack outcome from cash that hope to be invested in credit loans or outcome from deficit cash that needed to meet their short-term obligations.

2. Literature Review

According to Ainley et al. (2007) In daily business transactions, there are many types of risks which are involving in all business institutions due to their financial crises. In daily business transactions, banks are facing some risk which caused by their activities. There will be no bank if there is no chance to take risk. This lack outcome from cash that hopefully to be invested in credit loans or outcome from deficit cash that needed to meet their short-term obligations in view of Murtunez and Repullo (2010) that Liquidity risk is the risk to earnings or capital from a banks inability to meet its obligations when they come due, without incurring unacceptable losses. Liquidity risk includes the inability to manage unplanned decreases or changes in funding sources.

There are several risks that must be considered by banks, for example: market risk, operational risk, legal risk, compliance risk, credit risk, and liquidity risk (Perotti et al 2011). One of that above risks one crucial risk is liquidity risk that comes from the mismatched timing between cash inflow and cash outflow. According to the Impact of Liquidity Risk on Banks (A Case Study of Punjab, Pakistan), observe that liquidity risks have played a role in bringing financial distress to Islamic banks and some of them were forced to close. Market liquidity risk is the risk in which financial institutions could incur, if there is no more market for the asset where it should be sale. Funding liquidity risk is a risk which has linked to a wrong management on funding position. There are the following the sources of liquidity risk, Incorrect judgment and complacency, Unanticipated change in cost of capital, Abnormal behavior of financial markets, Range of assumptions used, Risk activation by secondary sources, Break down of payments system, Macroeconomic imbalances, Contractual forms and Financial Infrastructure deficiency.

Liquidity is divided into two types by the author the one is the liquidity of assets which is defined as the inability to sell assets at current market prices and liquidity instability of liability which is defined as the inability to assess sufficient funds to meet payment obligations in a timely manner (Arab & Anas, 2008). A bank with a strong liquidity profile should generally be able to survive. Much of the funds of Islamic financial institutions come through PLS investment accounts without any fixed obligation attached to them. Rather the problem for Islamic financial institutions has been excess liquidity. Islamic banks need to be even more cautious about the maturity structure of their assets. In order to remain solvent, banks need to maintain assets of a short-term nature. The Establishment of specialized institutions for managing liquidity risks has helped to solve the liquidity problems. This paper argues for the need for Islamic banks to strengthen risk management practices. Without an efficient capital market to operate within, Islamic banking finance will not continue to grow meaningfully. The market requires liquidity and price transparency to enhance a secondary market. According to the wikipedia the banking sector in Bangladesh consists of several types of institutions. Bangladesh Bank is the central bank of Bangladesh and the chief regulatory authority in the banking sector. There is a total of 41 PCBs (Public Commercial Banks) in Bangladesh are in operation right now. They are majorly owned by private entities and classified into two types. From those 33 banks are conventional PCBs and 8 banks are Islamic PCBs. Bangladesh also has 6 state-owned commercial banks (SOCBs) and those are Sonali Bank Limited, Janata Bank Limited, Agrani Bank Limited, Rupali Bank Limited, BASIC Bank Limited and Bangladesh Development Bank Limited.

According to the Ibe, S.O. (2013) stated that liquidity management is indeed a crucial problem in the banking industry and recommended that banks should engage competent and qualified personnel in order to ensure that right decisions are adopted especially with the optimal level of liquidity and still maximize profit. In a study conducted by scholars, liquidity was represented by liquidity ratios, such as current ratio, quick ratio, etc. the main component of these ratios are current assets, current liabilities, etc (Khokhar,2015; Bolek, 2013). It was emphasized on cash as a major representative of liquidity status and as most liquidity assets to operate day to day business (Mahmud, 2014). There are numerous studies done in the past on liquidity, risk mitigation, and management.

3. Research Gaps

Previous researches that we have referred to is backdated, no latest research is available. That is why I want to conduct a research based on the data of recent 10 years. Also, the research that has been conducted previously are based on random selection of banks but here I will be taking major banks from the private and government sector of banking in Bangladesh. In this report also included recent incidents that banks face because of lack efficient bank liquidity management. Here I also made a comparison on liquidity management between two groups of banks. Those two group of banks are Commercial Private Banks of Bangladesh and Commercial State-Owned Banks of Bangladesh.

4. Objectives

The main objective or purpose of this report is evaluating and comprising the performance of some selected tools of Private Commercial Banks (PCBs) and State Own Commercial Banks (SOCBs) of Bangladesh. In below given the key objectives of this study:

- To study structural different between private and State-Owned Commercial banks of Bangladesh.
- To analyze whether there is any difference regarding the liquidity management of State Own and private banks on the basis of some selected tools
- To evaluate the liquidity related problems of the banks
- To understand the relation between profitability and liquidity management of banks

5. Methodology

The research methodology of the selected topic follows in these dimensions:

5.1 Population of the Study

The following two groups of Banks in Bangladesh:

- I. Private Commercial Banks
- II. State-Owned Commercial Banks

5.2 Sample periods

The study covered for Five years from the year 2009 to 2018.

5.3. Sources of Data

This study is based on secondary data. In below given the sources of those data and information:

- I. Annual reports of State-owned Commercial Banks and Private Commercial Banks of Bangladesh.
- II. Journals and Reports published by Bangladesh Bank
- III. Survey report analysis by Bangladesh Bank

5.4. Data Analysis Methods and Tool

As part of my research, I would like to first analyze the liquidity position of each bank and then take averages from each category to explain the differences. A regression model will be used to depict the liquidity risk variances with respect to certain independent variables. After that hypothesis testing will be conducted.

5.4.1 Variables

To analyze the financial performance of banking sector different are included in this study, they are following:

- Liquidity ratio
- Bank size
- Debt to equity ratio (D/E)
- Investment to asset ratio
- Return on equity (ROE)

- Liquid asset ratio (Total loans/ Total Deposits)

5.4.2 Regression Model

The regression model will be the following:

$$Y = \beta_0 + \beta_1 X_1 + \beta_2 X_2 + \beta_3 X_3 + \beta_4 X_4 + \beta_5 X_5 + e_t$$

Y= Liquidity risk

X₁= Bank size

X₂= Debt to equity ratio (D/E)

X₃= Investment to asset ratio

X₄= Return on equity (ROE)

X₅= Liquid asset ratio (Total loans/ Total Deposits)

e_t= Error term/Residual term

$\beta_0, \beta_1, \beta_2, \beta_3, \beta_4, \beta_5$ are the constant parameters (slope coefficients)

5.4.3 Hypothesis Test

Hypothesis testing will be based upon several null hypotheses. The followings will be the null hypotheses:

- I. H₀ : There is no significant difference in Bank size of two banking groups
H₁: There is significant difference in Bank size of two banking groups

- II. H₀: There is no significant difference in Debt to equity ratio of two banking groups.
H₁: There is significant difference in Debt to equity ratio of two banking groups.

- III. H₀: There is no significant difference in Investment to asset of two banking groups.
H₁: There is significant difference in Investment to asset of two banking groups.

- IV. H₀: There is no significant difference in Return on equity of two banking groups.
H₁: There is significant difference in Return on equity of two banking groups.

- V. H₀: There is no significant difference in Liquid asset ratio of two banking groups.
H₁: There is significant difference in Liquid asset ratio of two banking groups.

6. Data Analysis and Findings

6.1. Trend Analysis

Trend analysis is used in analysis to predict the future stock price movements based on previous trend data. Trend analysis is given trend of future movement based on past years data.

In below, I compared public banks and private banks based on their past year trend on those sector.

6.1.1. Liquidity Risk

Liquidity risk means cash crunch for short term period. That kind of ratio provides an opposite effect on company's profitability.

Formula of Liquidity Risk: Total Capital / Total Asset

By this ratio bank can find out their position on total capital biased on its total asset. Here net worth of bank is known as capital of bank. By deducting total liability from it total asset bank calculates it total capital. Bank only takes tier 1 asset as it total asset.

Figure 1: Trend Analysis on Liquidity Risk of Public Bank and Private Bank.

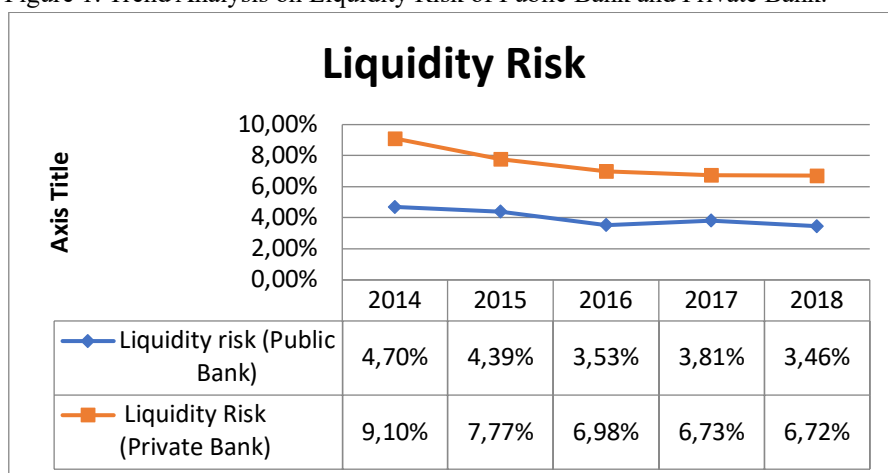

Source: Annual reports of Banks.

The liquidity risk of private banks of Bangladesh is seen to have a downward trend in the past 5 years. The highest is being in 2014 at 9.1% and reaching a constant at 2017 and 2018.

The liquidity risk of public banks of Bangladesh has an unstable trend, reaching lowest in 2016 and moving upward in 2017 and falling in 2018 again. In the case of comparison, Private Banks have more liquidity riskier than Public Banks. But private bank's liquidity risks are more downward than public banks. This is greater than public bank future trend. If we compare 2014 and 2018 liquidity risk of private banks and public banks, private banks reduce their liquidity risk more than public banks. Special in 2014 to 2015 we can notice more change in liquidity risk private banks. In the case public bank we can notice more change in 2015 to 2016 which is 4.39% to 3.53%.

6.1.2. Bank Size

Generally bank size means owners capital. High bank size enables the bank to offer more financial service at low cost or with high-profit rate.

Formula of Bank Size: $\text{Log}(\text{Total Asset of Bank})$

Degree of bank size helps to measure banks' mandatory liquidity needs. High degree of bank size requires fewer rates of liquidity and opposite situation for low degree of Bank Size.

Figure 2: Trend Analysis on Bank Size of Public Banks and Private Bank

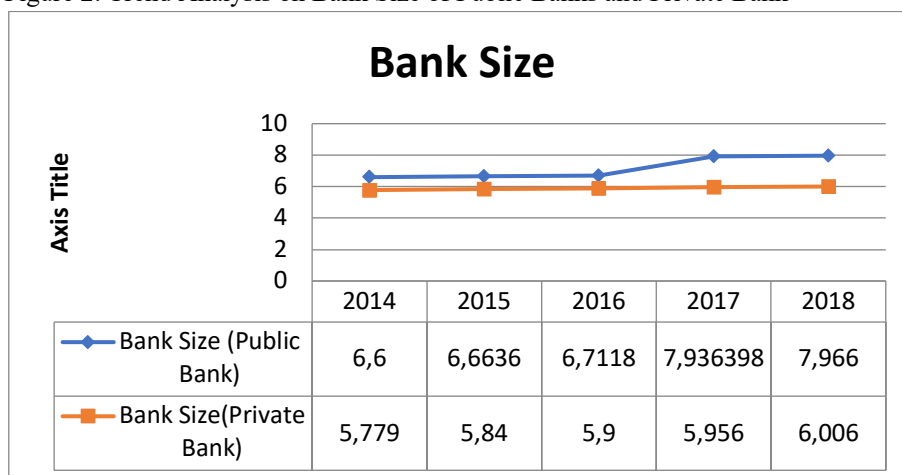

Source: Annual reports of Banks.

At first I discuss about public banks bank size. In 2018 public banks have high bank size which is 7.966. And 2014 they have less bank size which is 6.6. In the case of private banks, private banks bank sizes in 2018 have highest bank size as like public bank. Comparatively public banks size is larger than private banks. Private bank is more sustainable than public bank.

6.1.3. D/E Ratio

The debt-to-equity ratio indicates the relative proportion of shareholders' or owners' equity and debt used to finance a company's assets. It is also known gearing or leverage.

The formula of Debt to Equity ratio: $\text{Total Debt} / \text{Total Equity}$.

High degree of debt to equity ratio indicates high negative impact on liquidity. Low degree of debt to equity ratio indicates opposite effect.

Figure 3: Trend Analysis on D/E ratio of Public bank and Private Bank

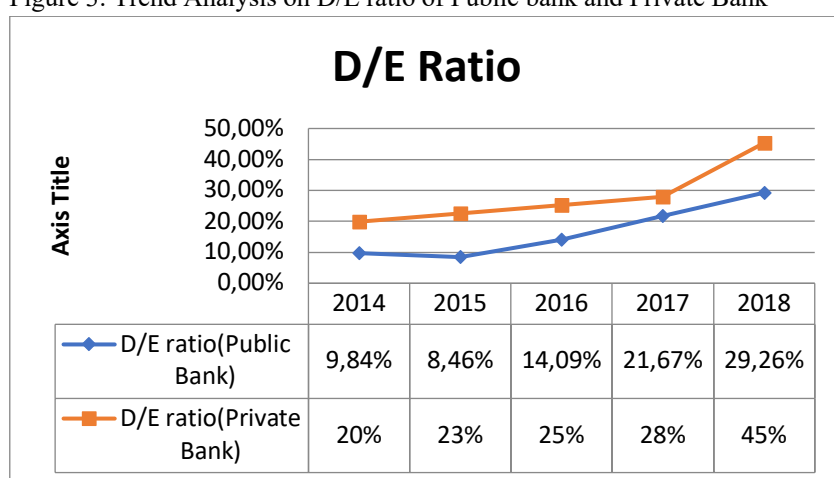

Source: Annual reports of Banks.

The debt to equity ratio of private banks on an average is rising, the highest being in 2018 at 29.26% and reaching the lowest in 2014 at 9.84%. This shows that the debt tendency of private banks in comparison to their equity portfolio is increasing day by day. The debt to equity ratio of public banks, however, is on a very upward trend. It can be said that the debt to ratio of public banks over the year is increasing at a stable rate. Comparatively private bank's debt to equity ratio is less than public bank. Which is seem good for private bank as high amount of debt is the sign of risky ness.

6.1.4. I/A Ratio

Investment to asset is known as return on investment ratio or return on return on asset ratio. Generally this ratio calculates gain on asset investment.

Formula of investment to asset ratio: $\text{Net Income} / \text{Total asset or Total Investment}$.

Liquidity risk is related negatively with this ratio. High rate of this ratio means less risk on income.

Figure 4: Trend Analysis on I/A Ratio of Public Banks and Private Banks

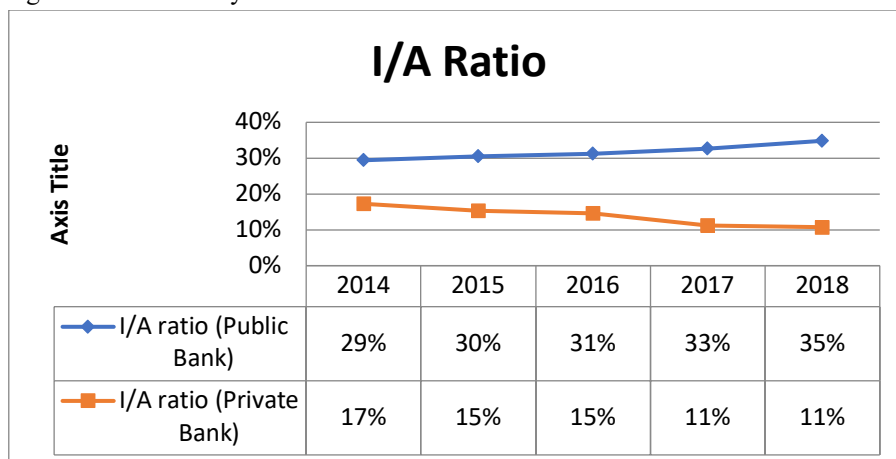

Source: Annual reports of Banks.

The investment to asset ratio of private banks on an average is falling, the highest being in 2014 at 17.26% and reaching the lowest in 2018 at 10.73%. This shows that the investment tendency of private banks in comparison to their asset portfolio is decreasing. The Investment to Asset ratio of public banks however is on a very upward trend. It can be said that the investment ratio of public banks over the year is increasing at a stable rate. Comparatively, private bank's investment to asset ratio is less than public bank, that means invest income of private bank is less than public bank.

6.1.5. ROE

The return on equity means the profitability of a bank in relation to the equity which is also known as net assets or assets minus liabilities. By this ratio banks find out their performance. ROE is a calculation of how greatly a bank uses investments to generate earnings growth.

Formula of ROE: $\text{Net Income} / \text{Total Equity}$

Theoretically degree of ROE is negatively related with liquidity risk of a Bank.

Figure 5: Trend Analysis on ROE of private and public banks.

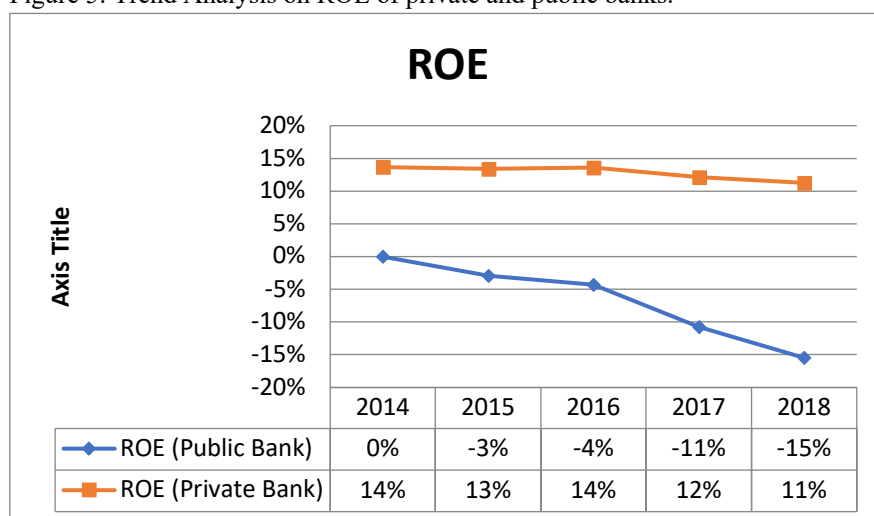

Source: Annual reports of Banks.

In the case of public bank ROE we can see that they have negative ROE that means public bank's return on equity is negative that means they are in the loss position in term of their ROE. In case of private bank in recent year

private bank loss their ROE. That's why their ROE becomes 11% to 12%. Comparatively, in the case of ROE, private bank is on the good position.

6.1.6. Liquid Asset

Liquid Asset ratio is a measure of bank's liquidity. It also measures how easily bank can service short-term liabilities if the need arises immediately.

Formula of Liquid Asset Ratio: $\text{Total Liquid Asset} / \text{Total Liquid Liability}$.

Theoretically, Liquid Asset ratio directly related with liquid risk of a bank negatively.

Figure 6: Trend Analysis on liquidity asset of public and private banks.

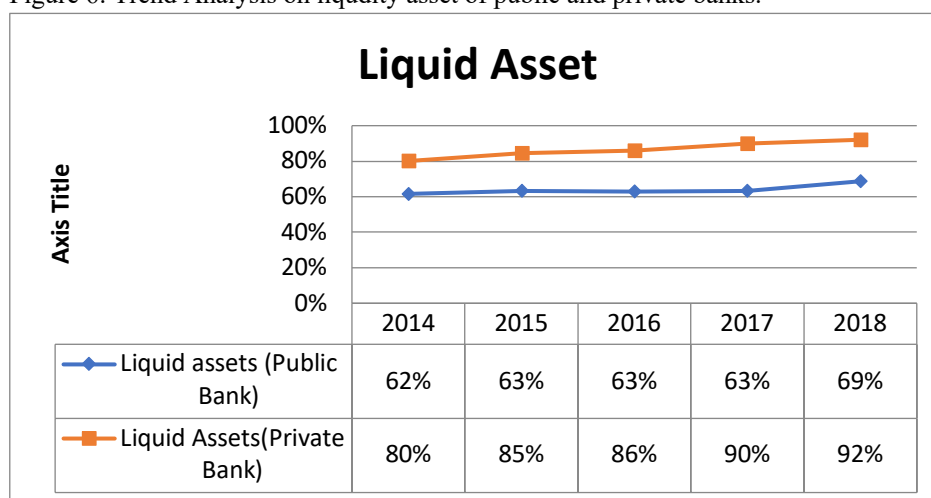

Source: Annual reports of Banks.

The liquid asset ratio of private banks is on an increasing trend, private banks are focusing more on to keep liquid assets. The liquid asset ratio trend of public banks is on an increasing trend as well, however the growth is lower than compared to the private banks. Private banks have more liquidity asset than public banks.

6.2. Regression

Regression is an analysis used in statistical disciplines that attempts to determine the relationship between one dependent variable (for my analysis dependent variable which is liquidity risk) and a series of other independent variable (in my analysis independent variables are investment to equity ratio, return on equity and liquid asset ratio).

6.2.1. Regression Analysis Output- Private Commercial Banks

Table 7: Regression Analysis Output- Private Commercial Banks.

<i>Regression Statistics</i>	
Multiple R	0.99943
R Square	0.998861
Adjusted R Square	0.995443
Standard Error	0.000684
Observations	5

ANOVA					
	<i>df</i>	<i>SS</i>	<i>MS</i>	<i>F</i>	<i>Significance F</i>
Regression	3	0.000411	0.000137	292.2785	0.042966
Residual	1	4.68E-07	4.68E-07		
Total	4	0.000411			

	<i>Coefficients</i>	<i>Standard Error</i>	<i>t Stat</i>	<i>P-value</i>	<i>Lower 95%</i>	<i>Upper 95%</i>
Intercept	0.414308	0.045016	9.203491	0.068901	-0.15768	0.986296
I/A ratio	0.144231	0.085626	1.684425	0.341072	-0.94376	1.232218
Liquid Assets	-0.29047	0.042612	-6.81647	0.092733	-0.83191	0.250975
ROE	-0.84403	0.086331	-9.77663	0.064891	-1.94098	0.252915

Source: Own Calculation

Regression Equation

$$Y = 0.414 + 0.144X_1 - 0.290X_2 - 0.844X_3 + e_t$$

Interpretation:

The intercept of 0.414 means that if all other factors are held constant then the Liquidity risk for private banks will be 0.414, this does not have any practical explanation.

The coefficient of the variable I/A ratio is 0.144 means that if all other factors are held constant then 1 percentage increase in I/A ratio will increase Liquidity risk by 14.4%

The coefficient of the variable Liquid Assets is -0.290 means that if all other factors are held constant then 1 percentage increase in Liquid Assets will decrease Liquidity risk by 29%.

The coefficient of the variable ROE is -0.844 means that if all other factors are held constant then 1 percentage increase in ROE will decrease Liquidity risk by 84.4%

F- Test

The significance value of F test is 0.042966 which is below the significance level of 5% which shows that the variables taken in this analysis combined are significant. This means that I/A, ROE and liquid asset ratio combined affect the Liquidity Risk. The null hypothesis that I/A, ROE and Liquid asset ratio do not have an impact on ROA, therefore, can be rejected.

Multiple R

Multiple R measures the variation in the dependent variable with respect to the independent variables. Here the value of multiple r is 0.999 which is 99.9%, this shows that the 99.9% of the variation in Liquidity Risk is explained by the independent variables taken in this analysis namely I/A, ROE, Liquid asset ratio.

5.2.3. Regression Analysis Output- State Own Commercial Banks

Figure 8: . Regression Analysis Output- State Own Commercial Banks.

Regression Statistics						
Multiple R	0.999007					
R Square	0.998015					
Adjusted R Square	0.992058					
Standard Error	0.000486					
Observations	5					

ANOVA					
	<i>df</i>	<i>SS</i>	<i>MS</i>	<i>F</i>	<i>Significance F</i>
Regression	3	0.000119	3.95E-05	167.5522	0.056715
Residual	1	2.36E-07	2.36E-07		
Total	4	0.000119			

	<i>Coefficients</i>	<i>Standard Error</i>	<i>t Stat</i>	<i>P-value</i>	<i>Lower 95%</i>	<i>Upper 95%</i>
Intercept	0.376029	0.0269	13.97902	0.045464	0.034238	0.717819
I/A ratio	-1.81604	0.127465	-14.2474	0.04461	-3.43563	-0.19645
ROE	-0.40684	0.034928	-11.6478	0.054522	-0.85064	0.036966
Liquid assets	0.332284	0.027584	12.04622	0.052727	-0.01821	0.682773

Source: Own Calculation

Regression Equation

$$Y = 0.376 - 1.816X_1 - 0.407X_2 + 0.332X_3 + e_t$$

Interpretation:

The intercept of 0.376 means that if all other factors are held constant then the Liquidity risk for private banks will be 0.376, this does not have any practical explanation.

The coefficient of the variable I/A ratio is 1.816 means that if all other factors are held constant then 1 percentage increase in I/A ratio will increase Liquidity risk by 185%.

The coefficient of the variable Liquid Assets is .33 means that if all other factors are held constant then 1 percentage increase in Liquid Assets will increase Liquidity risk by 33%.

The coefficient of the variable ROE is -0.407 means that if all other factors are held constant then 1 percentage increase in ROE will decrease Liquidity risk by 40.7%

F- Test

The significance value of F test 0.056715 which is below the significance level of 10% which shows that the variables taken in this analysis combined are significant. This means that I/A, ROE and liquid asset ratio combined affect the Liquidity Risk. The null hypothesis that I/A, ROE and Liquid asset ratio do not have an impact on ROA, therefore, can be rejected.

Multiple R

Multiple R measures the variation in the dependent variable with respect to the independent variables. Here the value of multiple r is 0.999 which is 99.9%, this shows that the 99.9% of the variation in Liquidity Risk is explained by the independent variables taken in this analysis namely I/A, ROE, Liquid asset ratio.

6.2.3. Comparative Discussion Based on Regression Result

Table 9: Comparative Discussion Based on Regression Result

Categories'	Private Bank	Commercial Bank	P value	State Own Commercial Bank	P value
Multiple R	0.99943			0.999007	
R Square	0.998861			0.998015	
Adjusted R Square	0.995443			0.992058	
Standard Error	0.000684			0.000486	
Observations	5			5	
Intercept	0.414308		0.068901	0.376029	0.045464
I/A ratio	0.144231		0.341072	-1.81604	0.04461
ROE	-0.29047		0.092733	-0.40684	0.054522
Liquid assets	-0.84403		0.064891	0.332284	0.052727

Source: Own Calculation

In the case of private bank and public bank, Multiple R measures the variation in the dependent variable with respect to the independent variables. Here the value of multiple r is 0.999 which is 99.9%, this shows that the 99.9% of the variation in Liquidity Risk is explained by the independent variables taken in this analysis namely I/A, ROE, Liquid asset ratio.

In the case of private bank the intercept of 0.414 means that if all other factors are held constant then the Liquidity risk for private banks will be 0.414, this does not have any practical explanation.

In the case of public bank the intercept of 0.376 means that if all other factors are held constant then the Liquidity risk for private banks will be 0.376, this does not have any practical explanation.

In the case of private bank the coefficient of the variable I/A ratio is 0.144 means that if all other factors are held constant then 1 percentage increase in I/A ratio will increase Liquidity risk by 14.4%.

In the case of public bank the coefficient of the variable I/A ratio is 1.816 means that if all other factors are held constant then 1 percentage increase in I/A ratio will increase Liquidity risk by 185%.

In the case of private bank the coefficient of the variable Liquid Assets is -0.290 means that if all other factors are held constant then 1 percentage increase in Liquid Assets will decrease Liquidity risk by 29%.

In the case of public bank the coefficient of the variable Liquid Assets is .33 means that if all other factors are held constant then 1 percentage increase in Liquid Assets will increase Liquidity risk by 33%.

In the case of private bank the coefficient of the variable ROE is -0.844 means that if all other factors are held constant then 1 percentage increase in ROE will decrease Liquidity risk by 84.4%

In the case of public bank the coefficient of the variable ROE is -0.407 means that if all other factors are held constant then 1 percentage increase in ROE will decrease Liquidity risk by 40.7%

6.3. Hypothesis Testing

Hypothesis testing is needed to infer the result of a hypothesis performed on sample data from a larger population. The test helps to the analyst whether or not her primary hypothesis is true.

6.3.1. Hypothesis Test for Private Banks

- i) H_0 : Investment to asset has no influence on the liquidity risk
 H_1 : Investment to asset has influence on the liquidity risk

In the case of private bank, the p-value of the variable I/A ratio is 0.341072 which is higher than 5% significance level, this variable is not significant, so the null hypothesis that I/A ratio has no influence on the liquidity risk is accepted

- ii) H_0 : Return on equity has no influence on the liquidity risk
 H_1 : Return on equity has influence on the liquidity risk

The p-value of the variable ROE is 0.092733 which is also below the 10% significance level, this variable is also significant, hence the null hypothesis that Return on equity has no influence on the liquidity risk is therefore rejected. But with 5% significant level this result would be accepted.

- iii) H_0 : Liquid asset ratio has no influence on the liquidity risk
 H_1 : Liquid asset ratio has influence on the liquidity risk

The p-value of the variable Liquid asset is 0.064891 which is also below the 10% significance level, this variable is also significant, hence the null hypothesis that Liquid asset has no influence on the liquidity risk is therefore rejected. But with 5% significant level this result would be accepted.

6.3.2. Hypothesis Test For Public Banks

- i) H_0 : Investment to asset has no influence on the liquidity risk
 H_1 : Investment to asset has influence on the liquidity risk

In the case of private bank, the p-value of the variable I/A ratio is 0.04461 which is also below the 5% significance level, this variable is also significant, hence the null hypothesis that I/A ratio has no influence on the liquidity risk is therefore rejected.

- ii) H_0 : Return on equity has no influence on the liquidity risk
 H_1 : Return on equity has influence on the liquidity risk

The p-value of the variable ROE is 0.054522 which is also equal to the 5% significance level, this variable is also significant, hence the null hypothesis that Return on equity has no influence on the liquidity risk is therefore rejected.

- iii) H_0 : Liquid asset ratio has no influence on the liquidity risk
 H_1 : Liquid asset ratio has influence on the liquidity risk

The p-value of the variable Liquid asset is 0.052727 which is also equal to the 5% significance level, this variable is also significant, hence the null hypothesis that Liquid asset has no influence on the liquidity risk is therefore rejected.

6.3.3. Comparison

Table 10: Regression Comparison among state owned public banks

	PCBs	P value	Test of Significance	SCBs	P Value	Test of Significance
Multiple R	99.98%			99.94%		
F- Value	292.2785			167.5522		
Significance F	0.042966		Significant	0.056715		Significant
Intercept	0.414308	0.068901		0.376029	0.045464	
I/A ratio	0.144231	0.341072	Insignificant	-1.81604	0.04461	Significant
ROE	-0.29047	0.092733	Significant For 10%	-0.40684	0.054522	Significant
Liquid assets	-0.84403	0.064891	Significant For 10%	0.332284	0.052727	Significant

Regression Equation for PCBs (Private Commercial Banks): $Y = 0.414 + 0.144X_1 - 0.290X_2 - 0.844X_3 + e_t$

Regression Equation SCBs (State Owned Commercial Banks): $Y = 0.376 - 1.816X_1 - 0.407X_2 + 0.332X_3 + e_t$

Table 11: Comparison Hypothesis Testing between PSBs and SCBs

Null Hypotheses\Significance level	PCBs		SCBs	
	5%	10%	5%	10%
i) H₀: Investment to asset has no influence on the liquidity risk	Accepted	Accepted	Rejected	Rejected
ii) H₀: Return on equity has no influence on the liquidity risk	Accepted	Rejected	Rejected	Rejected
iii) H₀: AD ratio has no impact on ROA	Accepted	Rejected	Rejected	Rejected

Source: Own Calculation

In the case of private bank, the p-value of the variable I/A ratio is 0.341072 which is higher than 5% significance level, this variable is not significant, so the null hypothesis that I/A ratio has no influence on the liquidity risk is accepted. In the case of public bank, the p-value of the variable I/A ratio is 0.04461 which is also below the 5% significance level, this variable is also significant, hence the null hypothesis that I/A ratio has no influence on the liquidity risk is therefore rejected.

In the case private bank the p-value of the variable ROE is 0.092733 which is also below the 10% significance level, this variable is also significant, hence the null hypothesis that Return on equity has no influence on the liquidity risk is therefore rejected. But with 5% significant level this result would be accepted. In the case of public bank the p-value of the variable ROE is 0.054522 which is also equal to the 5% significance level, this variable is also significant, hence the null hypothesis that Return on equity has no influence on the liquidity risk is therefore rejected.

In the case of private bank the p-value of the variable Liquid asset is 0.064891 which is also below the 10% significance level, this variable is also significant, hence the null hypothesis that Liquid asset has no influence on the liquidity risk is therefore rejected. But with 5% significant level this result would be accepted. In the case of

public bank the p-value of the variable Liquid asset is 0.052727 which is also equal to the 5% significance level, this variable is also significant, hence the null hypothesis that Liquid asset has no influence on the liquidity risk is therefore rejected.

7. Concluding Remarks

Private Banks have more liquidity riskier than Public Banks. But private bank's liquidity risks are more downward than public banks. Public banks size is larger than private banks. Private bank is more sustainable than public bank. Private bank's debt to equity ratio is less than public bank. Which is seem good for private bank as high amount of debt is the sign of riskiness. Private bank's investment to asset ratio is less than public bank, that means invest income of private bank is less than public bank. ROE of private bank is on the good position. Private Banks have more liquidity asset than public banks. So private should work with its liquidity risk reduction. And public bank should decrease their debt to equity ratio. However, banking is an industry that is everyday changing and to keep an updated idea of the industry more research must be done on a frequent basis and with updated data to have a real idea.

References

- Auty, R. M (2001) The political economy of resource-driven growth; *European Economic Review*, vol 45, 839–846.
- Akhtar, M. F., Ali, K., & Sadaqat, S. (2011). "Liquidity Risk Management: A comparative study between Conventional and Islamic Banks of Pakistan". *Interdisciplinary Journal of Research in Business*, 1(1),
- Ahmed, N., Akhtar, M. F., & Usman, M. (2011). "Risk Management Practices and Islamic Banks: An Empirical Investigation from Pakistan". *Interdisciplinary Journal of Research in Business*, 1
- Allen, L. & Rai, A., 1996. Operational efficiency in banking: an international comparison. *Journal of Banking and Finance*, Volume 20 No. 4
- Ayub, M. (2007) *Understanding Islamic Finance*. John Wiley & Sons.
- Ben, N. S. & Goaid, M., 2001. The determinants of the Tunisian deposit banks'performance. *Applied Financial Economics*, Volume 11 No.2
- Business Journals from www.google.com
- Bangladesh Bank website: <https://www.bb.org.bd>
- Daily Star website: www.thedailystar.net
- Faghih, M (2004) Credit Risk Management and its policies (applied approach), *journal of bank and economy*, No. 46.
- Ismal, R. (2010). "Strengthening and improving the liquidity management in Islamic banking". *Humanomics*, investopedia website: www.investopedia.com
- Leilidoust, M (2008) Measuring liquidity risk and its relation with profitability in Mellat bank", Master Thesis, Tehran, Higher Institute of Banking.
- WORKING CAPITAL MANAGEMENT AND PROFITABILITY: A STUDY ON CEMENT INDUSTRY IN BANGLADESH, Md. Ariful Hoque, Md. Amin Mia and S.M. Rakibul Anwar
- wikipedia website: www.wikipedia.com



Firm Characteristics and Stock Returns of Nigerian Quoted Firms: A Two-Sector Comparative Analysis

Akinyemi Kayode Peter¹, Oke Mike Ojo², Olaolu Adegboyega Adewoye³

¹Lecturer, Department of Banking and Finance, Adekunle Ajasin University, Akungba Akoko, Nigeria. Telp: +2347032236545. Email: akinyemipeter252@gmail.com

²Senior Lecturer, Department of Finance, Ekiti State University, Ado-Ekiti, Nigeria

³Department of Banking and Finance, Kwara State Polytechnic, Ilorin, Nigeria

Correspondence: Kayode Peter Akinyemi. Email: akinyemipeter252@gmail.com

Abstract

This study examines the relationship between firm characteristics and the stock returns selected banks and manufacturing companies quoted on the Nigerian Stock Exchange on a two-sector basis. The study employs pooled/panel data analytical techniques to analyze the financial data of 15 banks and 15 manufacturing companies quoted on the Nigerian Stock Exchange as of December 31st, 2018. The study finds the effect of firm characteristics on the stock return of financial sector firms is sharply different from that of the manufacturing sector firms. Through the fixed effect model result it was found that in the financial sector, earnings per share and liquidity have a positive and statistically significant relationship with a stock return while return on assets has a negative and statistically significant effect on stock return. Other variables (leverage, market capitalization and sales growth rate) effects on stock return are not statistically significant. On the other hand, in the manufacturing sector, out of the six firm characteristic variables, only market capitalization has a positive and statistically significant effect on stock return. The effects of the other five were not significant. Furthermore, the test of causality shows that in the financial sector, earnings per share, return on assets and liquidity ratio have causal links with stock return. However, in the manufacturing sector, market capitalization and earnings per share have a causal link with stock return. The study recommends that firm managers should develop strategies that will consistently improve stock price, which determines market capitalization and, to some extent, stock returns. Also, financial firms should be wary of overinvestment in assets and/or its underutilization. The need to acquire is desirable. But this can also cause problems when such assets idle away or the cost of maintaining them eats so much into the revenue of the firm. Finally, management should maintain a healthy balance between liquidity and investments; and, policy makers to design and execute policies that are sector sensitive rather than generic in nature.

Keywords: Stock Return, Firm Characteristics, Panel Regression, Granger Causality

1. INTRODUCTION

Broadly, there are two major objectives of the firm: profit maximization and shareholders' wealth maximization. Other goals such maximization of sales revenue, growth of assets, managerial leisure, managers' satisfaction, market share, power, cost minimization, among others are expected to still aim at the two primary goals (Kotlar, De-Massis, Wright & Fretini, 2018).

The profit maximizing goal of the firm is the most popular goal which implies that all managerial decisions and actions should be directed toward the sole end of maximizing profit for the firm. The wealth maximization objective, on the other hand, simply means that business managers direct their activities towards the maximization of the present value of a firm measured in terms of the current market worth of the firm. The current market value of a firm is usually regarded as the price of its stock on the floor of the Stock Exchange market at a given time. To maximize the value of the firm, management is expected to efficiently manage firm characteristics which include activities that form part of the day-to-day and longer-term operations of the firm such as liquidity, profitability, capital structure, market share, investment and earning power. Prombutr and Phengpis (2019) posit that firm characteristics are cogent explainers of stock returns as they are seen as drivers of information and sentiments on stock prices.

Although firm-level characteristics bear the same name among firms, the strategies employed by management in controlling these characteristics differ from one firm to the other. For instance, Prombutr and Phengpis (2019) believe that the behavioural firm level characteristics are the most potent explainers of stock market returns. The extent to which these characteristics are efficiently managed can, to a large extent, dictate the level of stock returns. This is due to the fact that these characteristics dictate the thrust of the firms.

In the modern day dynamic business environment where micro and macroeconomic variables that exert much influence of the operations of the firm keep changing, continuous research is necessary to identify the characteristics that affect organizational performance and value. Ample empirical literature exists on the relationship between firm based characteristics and stock returns of Nigerian quoted firms, but these literatures reveal contradicting results, essentially due to the variables analyzed and the fact that the studies were conducted under different micro- and macro-economic conditions. Some researchers find that firm level characteristics have positive and significant effects on stock return (Uwubanmwun & Obayagbona, 2012; Okoro & Stephen, 2014; Idris & Bala, 2015).while others discover negative and significant effects. Yet, other findings reveal a no-significant relationship situation (Idris & Bala, 2015). The inconsistencies in these findings call for more research to be carried out on the relationship between these firm level characteristics and the stock returns of selected quoted firms in Nigeria. More importantly, this research is intended to make a comparison of the effects of firm level characteristics on stock returns of firms in the financial sector of the Nigerian economy with that of the manufacturing sector. To the best of this researcher's knowledge, researchers are yet to do much in the attempt to ascertain whether the effects in these two sectors are in anyway different. So far, empirical works have concentrated on establishing the relationship between firm level characteristics and stock returns either on individual firm's basis or on a group of firms' basis. This research seeks to fill this gap created in literature by comparing these effects between the two principal sectors of the economy so as to establish the existence or otherwise of any structural change between them.

The general objective of this study is to examine the effect of firm level characteristics on the stock returns of selected financial and manufacturing firms in Nigeria. However, the specific objectives of the study are to:

- i. determine the effects of firm level characteristics on the stock returns of selected quoted financial firms in Nigeria;
- ii. determine the effects of firm level characteristics on the stock returns of selected quoted manufacturing firms in Nigeria;
- iii. compare the effect of firm level characteristics on the stock returns of selected financial firms with that of selected manufacturing firm in Nigeria; and,
- iv. examine the direction of causality between firm level characteristics and stock returns of selected quoted financial and manufacturing firms in Nigeria.

2. LITERATURE REVIEW

2.1 Firm Level Characteristics

Business organizations have specific plans, policies, decisions, programmes and processes that shape their daily operations. These are firm level characteristics which form the fulcrum of business firms' activities. They are,

most times, expressed in figures for ease of accounting measurement. Mgeni and Nayak (2016) state that different researchers view firm characteristics in different ways depending on the criteria they use to define it. Notwithstanding, most researchers tend to agree that firm characteristics are related with firm resources and organizational objectives. Kisengo and Kombo (2012) state that firm level characteristics can be broadly categorized into three main groups: structure, capital and market-related. Firm structure related characteristics are firm size, ownership and age; the market related characteristics include industry type, environmental uncertainty and market environment while the capital-related characteristics refer to liquidity and capital intensity.

2.2 Stock Return

Stock return is the gain accruable to an investor based on the number of stock such an investor has in the organization. Idris and Bala (2015) define stock return as the returns or gain that the investors generate out of the stock market. Theoretically, stock return is calculated as:

$$\frac{\text{Stock price in the current year} - \text{Initial stock price} + \text{Current dividend}}{\text{Initial stock price}} \times 100 \quad (2.1)$$

2.3 Theoretical Literature

2.3.1 Determinants of Stock Return

The theoretical basis for the determinants of stock returns can be tied to the theories of firms value as advanced by Modigliani and Miller (1961), popularly called the dividend irrelevancy theory; the trade-off theory (Myers, 1964); the agency theory; the asymmetric information theory, the pecking order theory (Myers & Majiluf, 1984) and the traditional approach (Solomon and Weston (1963). Other theories, apart from the Modigliani and Miller (M-M, 1961) proposition are against the dividend irrelevancy school of thought. These other theories relax the assumptions upon which the M-M hypotheses were based and hence argue that assumptions such as the existence of perfect capital market, absence of transaction cost and the non-existence of income taxes cannot hold in a real world situation. The Capital Assets Pricing Model (CAPM) proposed by Sharpe (1964), Linter (1965) and Black (1972) were all premised on the assumption that the stock market is efficient and that securities are rightly priced and stock returns can be ascertained by the level of risk the investor assumes. The premise on which the CAPM is built has made it not only defective, but unable to sufficiently predict stock returns. Uwubanmwun and Obayagbona (2012) argue that since the CAPM only captures the systematic risk (firm based), other variables which are out of the control of management (for example, macroeconomic variables such as inflation rate, money market rates, gross domestic product, exchange rates, etc.) also exert great influence in determining or predicting stock returns reliably. This position had earlier been held by Fama and French (1992); Basu (1997) and Drew (2003) among others.

Kogan and Papanikolaou (2012) provide a theoretical model that links firm level characteristics to stock returns using technological shocks as the main component of the model. The researchers observe that firm based characteristics such as Tobin's Q, previous investment spending, earnings-price ratios, market betas, and stock price volatility help predict the share of growth opportunities in the firm's market value,

2.4 Empirical Literature

Stakeholders in business organizations are naturally interested in how their interests in such organizations are faring. Managements, shareholders, investors, customers as well as the government should be interested in the performance of business organizations in the economy. For management, organizational performance is a measure of their managerial capabilities; and to investors and shareholders, corporate performance reveal how well their investment is doing. Customers are interested in firms' performance in order to determine whether they will continue doing business with such firms or not while the government is interested in firms' performances, not only for tax purposes, but also for the formulation and implementation of policies that will aid overall economic

development. Of particular concern to shareholders is the behaviour of return on their stock holding in firms. Shafana, Rinziya and Jariya (2013) state that though shareholders, researchers and policy makers pay more attention to macroeconomic variables, there are other firm level factors that explain stock returns. Such factors include earnings power, dividends payout, risks, leverage, size and liquidity, among others. Prombutr and Phengpis (2019) study the behavioural-related variables within the firms as determinants of stock return in Pakistan and find that more than covariance risks associated with investment, growth and size, behavioural characteristics determine stock returns of firms. Yang, Ryu and Ryu (2017), while studying investors' sentiments and assets return in Korea, analyze a dataset of firms listed on the Korean stock exchange, find that when investor sentiment is high, stock returns are most likely to increase.

Idris and Bala (2015) study the effects of firm characteristics on the stock returns of 9 out of the 21 food and beverage firms quoted on the Nigerian Stock Exchange as at 31st December, 2013. The researchers use panel data regression techniques to examine the relationship between stock market returns and three firm based characteristics namely, market capitalization, earnings per share and debt-to-equity ratio. Their findings show that while debt-to-equity ratio and earnings per share have positive and significant relationship with stock returns, market capitalization has negative and significant relationship with stock returns. Okoro and Stephen (2014) examine the determinants of stock price movement in Nigeria for the period 2001-2011 by analyzing the data of 99 firms quoted on the Nigerian Stock Exchange with Ordinary Least Square. Among their findings is that earnings per share affect stock return positively and that the EPS has the strongest explanatory power in explaining stock price movement. In a study conducted by Olowoniyi and Ojenike (2012) to examine the determinants of stock returns of Nigerian listed firms, the researchers use panel data analytical techniques to analyze the financial data of 70 firms and find that expected growth rate and size have positive effects on stock return while tangibility (defined as total fixed assets divided by net profit after tax) inversely affect the stock return of listed firms. Earlier, Okafor (2007) studies the relationship between organizational characteristics and performance of quoted firms in Nigeria by constructing a 4-S (skill, staff, style and shared values) model. The researcher employs the ordinary least square (OLS) technique to analyze the data of a sample of quoted firms in Nigeria and finds that all the independent variables (skill, staff, style and shared values) have positive relationship with organizational performance. Adedoyin (2011) had earlier arrived at similar conclusion. Shafana, Rimziya and Jariya (2013) investigate the relationship between stock returns and firm size, and book-to-market equity of 12 firms listed on the Colombo (Sri Lanka) Stock Exchange. The authors discover that book-to-market equity affects stock return negatively and significantly and that firm size has no significant effect on stock returns. This finding is also in agreement with that of Chambers, Sezgin and Karaaslan (2013).

3. RESEARCH METHOD

3.1 Theoretical Framework

This research work is premised on the Capital Assets Pricing Model (CAPM) proposed by Sharpe (1964), Linter (1965) and Black (1972) which gives leanings to the fact that stock prices of firms are determined by systematic (firm based) risks.

3.2 Model Specification

This study employed a panel data analysis technique to examine the effect of firm-level characteristics on the stock return of 30 quoted firms in Nigeria. The research work used the panel data econometric technique to test the significance of the effects of selected firm level variables on the firms' stock return. The study adapted a model used by Idris and Bala (2015) in their research on firm's specific characteristics and stock market return (evidence from listed food and beverages firms in Nigeria) with modification. This study modified their model by incorporating firms' level characteristic from capital structure (leverage), earnings power (earnings per share), size (market capitalization), liquidity (current ratio), profitability (return on assets) and sales growth as independent variables for the selected quoted firms in Nigeria. The model for this research is specified as follows:

$$STR = f(LEV, MCAP, EPS, ROA, CUR, SGR) \dots\dots\dots(3.1)$$

Specifying equation (3.1) in econometric form, it becomes:

$$STR_{it} = a + \beta_1 LEV_{it} + \beta_2 MCAP_{it} + \beta_3 EPS_{it} + \beta_4 ROA_{it} + \beta_5 CUR_{it} + \beta_6 SGR_{it} + \varepsilon_{it} \dots \dots \dots (3.2)$$

Splitting equation 3.2 into the two sectors in our analysis, we have equations (3.3) and (3.4) for financial and manufacturing sectors respectively. That is,

$$STR_{FS} = a + \beta_1 LEV_{it} + \beta_2 MCAP_{it} + \beta_3 EPS_{it} + \beta_4 ROA_{it} + \beta_5 CUR_{it} + \beta_6 SGR_{it} + \varepsilon_{it} \dots \dots \dots (3.3) \text{ and}$$

$$STR_{MS} = a + \beta_1 LEV_{it} + \beta_2 MCAP_{it} + \beta_3 EPS_{it} + \beta_4 ROA_{it} + \beta_5 CUR_{it} + \beta_6 SGR_{it} + \varepsilon_{it} \dots \dots \dots (3.4) \text{ for financial and manufacturing sectors respectively}$$

where:

- STR_{FS} = Stock return of selected firms in the financial sector
- STR_{MS} = Stock return of selected firms in the manufacturing sector
- $LEV_{i,t}$ = Leverage ratios of selected firms i in period t .
- EPS_{it} = Earnings per share of selected firms i in period t .
- ROA_{it} = Return on assets of selected firms i in period t .
- CUR_{it} = Current ratio of selected firms i in period t .
- $MCAP_{it}$ = Market capitalization of selected firms i in period t .
- SGR_{it} = Sales growth rate of selected firms i in period t
- ε_{it} = stochastic error term.
- a = intercept
- β_1, \dots, β_6 = regression parameters
- i = individual firms
- t = time

3.3 Definition of Variables

Tables 3.1 and 3.2 define the dependent and explanatory variables used in the econometric models stated in equation (3.2).

Table 3.1: Definition of Dependent Variable

S/N	Variable	Definition
1	Stock Return	Current price of stock minus initial stock price plus current dividend, all divided by initial price of stock

Source: Author's compilation (2020)

Table 3.2: Definition of Independent Variables

S/N	Variable	Definition/Formula
1	Leverage Ratio (LEV)	$\frac{\text{Long-term debt capital}}{\text{Equity capital}}$
2	Market capitalization (MCAP)	Year-end share price x number of ordinary shares
3	Earnings Per Share (EPS)	$\frac{\text{Profit after tax}}{\text{Number of ordinary shares}}$
4	Return on assets	$\frac{\text{Profit after tax}}{\text{Total assets}}$
5	Current Ratio	$\frac{\text{Current assets}}{\text{Current liabilities}}$
6	Sales Growth Rate	$\frac{\text{Sales in the current year} - \text{Sales in the previous year}}{\text{Sales in the previous year}} \%$

Source: Author's compilation (2020)

3.4 Sources of Data

Data for this study were sourced from secondary sources. The sample size is purposive in nature as it is reliably assumed to be balanced representative of the population. The study used the annual data of 15 selected commercial

banks and 15 manufacturing firms quoted on the Nigerian Stock Exchange from year 2008 to 2018. The choice of 15 commercial banks and 15 manufacturing companies is due to the fact that all the firms quoted on the stock exchange as at December 31st, 2018 are realistically assumed to belong to either the financial (monetary) or manufacturing (real) sector of the economy. Also, the years under study is chosen in order to be able to get sufficient data of the firms under study. The data was sourced from the Nigerian Stock Exchange daily price list, and the annual financial reports of the selected firms.

3.5 Estimation Techniques

3.5.1 Panel Data Analysis

A panel data is in the form of n subjects, each with T observations measured at 1..... t period so that the total number of observations in the panel is nT . The data set for this study comprises of the stock returns, leverage ratio, return on assets, liquidity (current) ratio, earnings per share, sales growth and market capitalization of the selected firms. The data cover a period of ten (10) years from 2008-2018. The dependent variable is the stock return (STR) while the other variables are explanatory variables. In addition, fixed and random effect tests are carried out on the regression results to determine the preferred model.

The fixed effects model is denoted as

$$y_{it} = \alpha + \beta'X_{it} + \mu_{it}, \quad (3.4)$$

$$\mu_{it} = \mu_i + v_{it}. \quad (3.5)$$

μ_i are individual-specific, time-invariant effects because they are taken as fixed over time

The random effects model stated as:

$$\mu_i \approx i.i.d.N(0, \sigma_\mu^2) \quad (3.6)$$

and,

$$v_{it} \approx i.i.d.N(0, \sigma_v^2) \quad (3.7)$$

assumes that the two error components are independent from each other.

The Hausman test is used to select the most appropriate model out of the two. This test is employed to determine the existence of any significant difference between the estimates of the fixed effect regression and that of the random effect regression. It follows the asymptotic chi-square distribution with the null hypothesis that the random effect is most appropriate.

3.5.2 Test of Causality among Variables

In this study, Granger (1969) test of causality between dependent and explanatory variables is used to ascertain if there exists causality between stock return and firm characteristic variables and the direction of causality. Granger (1960) states the causality test in the form of:

$$Y_t = \sum_{i=1}^k a_i X_{t-i} + \sum_{j=1}^k b_j Y_{t-j} + u_{1,t} \quad (3.8)$$

$$X_t = \sum_{i=1}^k c_i Y_{t-i} + \sum_{j=1}^k d_j X_{t-j} + u_{2,t} \quad (3.9)$$

where X and Y in the equations are stationary time series.

Generally, the Granger causality test ascertains if previous changes in one stationary variable X_t can assist in predicting current behaviours in another stationary variable Y_t , more than the explanation provided by past changes in Y_t itself (Granger, 1969). If not, then X_t does not "Granger cause" Y_t .

The decision rule from Equations (3.8) and 3.9), is that the null hypothesis that X does not Granger cause Y is rejected if a_t and d_t are jointly significant.

3.6 Evaluation Techniques

The evaluation techniques used in this study to test for significance, reliability and theoretical consistency include the economic *a-priori* expectation, the statistical criteria (coefficient of multiple determination (R^2) and the test of overall significance (F -test).

3.7 *A-priori* Expectation

This study theoretically expects that earnings per share, dividend per share, total assets, sales growth and market capitalization have positive and significant relationship with stock return; while leverage ratio has negative and significant relationship with stock return.

4.0 ANALYSIS, FINDINGS AND DISCUSSION

4.1 Pooled Regression Results

This research made use of Pooled regression (Ordinary Least Square, OLS) technique in analyzing the data of 30 selected quoted firms in Nigeria. The pooled OLS regression result assumes that the coefficients and constant estimates are fixed for all cross sectional observations. That is, the OLS is based on the assumption of absence of heterogeneity in cross sectional and time series data.

Objective 1: Determination of the effects of firm level characteristics on the stock returns of selected quoted financial firms in Nigeria

Table 4.1 is the summary of pooled regression results of model 3.3 that show the relationship between firm characteristics and stock return of financial sector under study.

Table 4.1: Abridged Pooled OLS Regression Result for financial sector firms

Dependent Variable = STR				
Variable	Coefficient	Std. Error	t-Statistic	Prob.
LEV	5.12E-05	0.000283	0.180503	0.8571
MCAP	-0.001915	0.000769	-2.490963	0.0142
EPS	0.201674	0.027624	7.300665	0.0000
ROA	-0.024845	0.009873	-2.516382	0.0133
CUR	0.843579	0.192062	4.392216	0.0000
SGR	0.119044	0.117956	1.009218	0.3151
C	-0.651579	0.201435	-3.234681	0.0016
R-Squared			0.474192	
Adjusted R-Squared			0.445770	
<i>F</i> -Statistic			16.68392	
Prob (<i>F</i> -Statistic)			0.000000	

Source: Authors' computation (2020)

The first objective of this study is to find out the effects of firm based characteristics on the stock returns of the selected financial firms that are quoted on the Nigeria Stock Exchange (NSE). This objective is captured in the null hypothesis that firm based characteristics have no significant effect on stock returns of financial firms that are quoted on the NSE. The results in Table 4.1 show that two out of the six firm based characteristics (LEV and SGR) have positive but statistically insignificant effect on stock return. A unit increase in LEV and SGR will lead to a statistically insignificant effects of 0.0000512 and 0.119044 on STR as confirmed by probabilities of 0.8571 and

0.3151 for LEV and SGR respectively. EPS and CUR are positively and statistically significant effect on stock return. A unit rise in EPS and CUR will bring about a statistically significant increase of 0.201674 and 0.843579 increase in STR respectively as revealed by their probabilities of 0.0000 and 0.0000 respectively. The other two (MCAP and ROA) have negative and statistically significant effect on stock return. A unit increase in MCAP and ROA means that STR will fall to the tune of -0.001915 and -0.024845 respectively. This fall is statistically significant with probabilities of 0.0142 and 0.0133 for MCAP and ROA respectively.

The coefficient of determination (R^2) of 0.474192 implies that about 47% of the variations in stock returns are explained by the firm based characteristics studied while the remaining 53% is explained by other variables outside the scope of the research model. The F-Statistic (16.68392) and F-probability (0.0000) indicate that the research model is statistically significant in its overall assessment.

However, the OLS technique assumes that regression coefficients and constants are homogeneous for all cross-sectional observations. This assumption ignores the probability of individuality or heterogeneity among the 30 selected firms. This possibility of this assumption not holding necessitates the need to subject our results to fixed and random effect tests so as to know the most appropriate model that should be used in arriving at conclusion.

4.1.2 Fixed and Random Effect Tests

The basis for a fixed effect model is that it assumes heterogeneity or individuality of observations such that each selected firm has its distinct intercept value. In essence, the fixed-effect model assumes that though the intercept may differ across individual firms, it is fixed over time. The purpose of the fixed effect test is to reveal the effect of other variables that are outside of the pooled OLS model used in the study.

On the other hand, the random effect model assumes that all the subjects in the sample size (firms) possess a uniform mean value as intercept. The interpretation of this is that the heterogeneity is random and is included in the overall error term. The summary of both the fixed and the random effect tests results are shown in Table 4.2.

Table 4.2: Fixed and random effects models regression results for financial sector firms

Fixed Effects Model					Random Effects Model				
Dependent Variable = STR					Dependent Variable = STR				
Variable	Coefficient	Std. Error	t-Statistic	Prob.	Variable	Coefficient	Std. Error	t-Statistic	Prob.
LEV	0.000184	0.000223	0.822754	0.4127	LEV	0.000136	0.000218	0.623282	0.5344
MCAP	-0.000218	0.001111	-0.196658	0.8445	MCAP	-0.000815	0.000876	-0.93002	0.3544
EPS	0.109350	0.024799	4.409430	0.0000	EPS	0.131288	0.023577	5.568432	0.0000
ROA	-0.020842	0.007632	-2.731079	0.0075	ROA	-0.021968	0.007486	-2.93469	0.0041
CUR	0.473097	0.178002	2.657818	0.0092	CUR	0.594561	0.166763	3.565316	0.0005
SGR	0.067752	0.083770	0.808790	0.4206	SGR	0.076511	0.083432	0.917054	0.3611
C	-0.216993	0.191918	-1.130658	0.2610	C	-0.341292	0.189334	-1.80259	0.0742
<i>R-Squared</i>			0.778456		<i>R-Squared</i>			0.270565	
<i>Adjusted R-Squared</i>			0.732777		<i>Adjusted R-Squared</i>			0.231136	
<i>F-Statistic</i>			17.04183		<i>F-Statistic</i>			6.862084	
<i>Prob(F-statistic)</i>			0.000000		<i>Prob(F-statistic)</i>			0.000003	

Source: Author's computation (2020).

Table 4.2 contains the summary of the results of both the fixed and the random effect models for financial sector firms. The decision to use any of the above models and results will be determined by the Hausman test.

4.1.3 The Hausman Test for financial sector firms

The problem of errors in model specification that may arise in panel data analysis is the focus of Hausman (1978) test. This test assists in determining the right choice of model to use in ascertaining the existence (or otherwise) of substantial difference(s) between the estimates of the fixed and random effect estimators. The Hausman test statistic is expressed as an asymptotic chi-square distribution based on one hypothesis expressed in null and alternative forms as follows:

H₀: Random effect model is more appropriate

H₁: Fixed effect model is more appropriate

In order to determine which of the hypotheses to accept or reject, the probability of calculated Chi-statistic is compared with the 5% significance level. If Chi-statistic is higher than the 5% level of significance, then the null hypothesis cannot be rejected. The reverse will be the case if it is lesser. Table 4.3 contains the extract from the result of Hausman test.

Table 4.3: Extracts from Hausman test cross-section random effects test for financial sector firm

Test Summary	Chi-Sq. Statistic	Chi-Sq. d.f.	Prob.
Cross-section random	13.489183	6	0.0359

Source: Author's Computation with E-Views 8 (2020).

From Table 4.3, the value of Chi-Statistic is 13.489183 and its probability is 0.0359, which is less than the 5% significance level. This implies that the null hypothesis cannot be accepted and the alternative hypothesis cannot be rejected, hence, the fixed effect model is more appropriate for the purpose of analyzing the first objective of this study.

From Table 4.2, the fixed effect model estimates show that out of the six explanatory variables in model 3.3, two (EPS and CUR) have positive and statistically significant effects on STR. This is reflected in coefficients of 0.109350 and 0.47397 and probabilities of 0.0000 and 0.0092 respectively. A unit increase in EPS and CUR will lead to increases of 0.109350 and 0.4739 in STR respectively. In contrast, ROA has a negative and statistically significant effect on STR with coefficient of -0.020842 and probability value of 0.0075. An increase in ROA will lead to a reduction of -0.020842. LEV and SGR both have positive but statistically insignificant effects on STR with coefficients 0.000184 and 0.067752 and probabilities of 0.412 and 0.4206 respectively. On its part, MPCA has negative but statistically insignificant effect on STR with coefficient -0.000218 and a probability of 0.8445. While four of the explanatory variables, namely EPS, CUR, LEV and SGR agree with the *a-priori* expectation two, ROA and MCAP run contrary to it.

The coefficient of determination, R^2 a measure of the percentage of variable STR explained by the LEV, EPS, MCAP, ROA, CUR and SGR is 0.778456 implying that about 78% of the variations in STR is explained LEV, EPS, MCAP, ROA, CUR and SGR. The remaining 22% is explained by other variables outside the model. The *F*-Statistics of 17.04183 and its probability of 0.00000 imply that model 3.3 is statistically reliable to explain the effect of firm characteristics on stock returns of selected financial sector firms in Nigeria.

Objective 2: Determination of the effects of firm level characteristics on the stock returns of selected quoted manufacturing firms in Nigeria

The next focus of this study is to determine the relationship between firm characteristics and stock returns of selected manufacturing sector firms quoted on the Nigerian Stock Exchange.

Table 4.4 contains the abridged results of pooled regression for the manufacturing sector model.

Table 4.4: Abridged pooled regression result for manufacturing sector firms

Dependent Variable = STR				
Variable	Coefficient	Std. Error	t-Statistic	Prob.
LEV	-0.002812	0.005886	-0.477843	0.6336
MCAP	0.011065	0.005316	2.081502	0.0396
EPS	0.111523	0.027588	4.042434	0.0001
ROA	0.202987	0.059344	3.420500	0.0009
CUR	-2.900833	0.724689	-4.002864	0.0001
SGR	0.021459	0.087084	0.246419	0.8058
C	5.213758	1.158379	4.500910	0.0000
<i>R-Squared</i>			0.385812	
<i>Adjusted R-Squared</i>			0.354582	
<i>F-Statistic</i>			12.35394	
<i>Prob (F-Statistic)</i>			0.000000	

Source: Authors' Computation (2020)

Results from Table 4.4 show that three of the six explanatory variables, namely, MCAP, EPS and ROA have positive and statistically significant effect on STR with coefficients 0.011065, 0.111523 and 0.202987 and probabilities of 0.0396, 0.0001 and 0.0009 respectively. A unit increases in MCAP, EPS and ROA will bring about increases of 0.011065, 0.11523 and 0.202987 in STR respectively. The CUR has a negative and statistically significant effect on STR with coefficient -0.2900833 and probability of 0.0001. A unit increase in CUR will bring about a decline of 0.2900833 in STR. A unit increase in LEV will also bring about a decline of 0.002812 in STR but the relationship is not statistically significant ($p=0.6336$). Lastly, a unit rise in SGR will lead an increase of about 0.021549 in STR though the effect is statistically insignificant ($p=0.8058$).

The coefficient of determination, R^2 a measure of the percentage of variable STR explained by the LEV, EPS, MCAP, ROA, CUR and SGR is 0.385812 implying that only about 39% of the variations in STR is explained LEV EPS, MCAP, ROA, CUR and SGR. The remaining 61% is explained by other variables outside the model. The F -Statistics of 12.35394 and its probability of 0.00000 imply that model 3.4 is statistically reliable to explain the effect of firm characteristics on stock returns of selected manufacturing sector firms in Nigeria. The results of the fixed and random effects tests are shown in Table 4.5

Table 4.5: Fixed and random effects model regression results for manufacturing sector firms

Fixed Effects Model					Random Effects Model				
Dependent Variable = STR					Dependent Variable = STR				
Variable	Coefficient	Std. Error	t-Statistic	Prob.	Variable	Coefficient	Std. Error	t-Statistic	Prob.
LEV	-0.005218	0.003334	-1.56511	0.1206	LEV	-0.004709	0.003272	-1.43887	0.1528
MCAP	0.011404	0.006024	1.893030	0.0411	MCAP	0.011233	0.005148	2.181893	0.0311
EPS	0.028652	0.016537	1.732591	0.0861	EPS	0.040224	0.015939	2.523576	0.0129
ROA	0.030068	0.039551	0.760227	0.4488	ROA	0.067045	0.037968	1.765841	0.0800
CUR	-0.004854	0.545048	-0.00891	0.9929	CUR	-0.694004	0.512338	-1.35458	0.1781
SGR	0.075762	0.046525	1.628429	0.1065	SGR	0.061713	0.046061	1.339812	0.1829
C	2.583067	0.834042	3.097047	0.0025	C	3.492892	0.995230	3.509634	0.0006
<i>R-Squared</i>			0.865855		<i>R-Squared</i>			0.171399	
<i>Adjusted R-Squared</i>			0.840058		<i>Adjusted R-Squared</i>			0.129266	
<i>F-Statistic</i>			33.56412		<i>F-Statistic</i>			4.068104	
<i>Prob(F-statistic)</i>			0.000000		<i>Prob(F-statistic)</i>			0.000961	

Source: Author's computation (2020).

Table 4.5 contains the summary of the results of both the fixed and the random effect models for manufacturing sector firms. The decision to use any of the above models and results will be determined by the Hausman test.

4.1.4 The Hausman Test for manufacturing sector firms

Table 4.6

Test Summary	Chi-Sq. Statistic	Chi-Sq. d.f.	Prob.
Cross-section random	46.712747	6	0.0000

Source: Author's Computation with E-Views 8 (2020).

From Table 4.6 the value of Chi-Statistic is 46.712747 and its probability is 0.0000, which is less than the 5% significance level. This implies that the null hypothesis cannot be accepted and the alternative hypothesis cannot be rejected, hence, the fixed effect model is more appropriate for the purpose of analyzing the first objective of this study.

The estimates of the fixed effect model show that MCAP, EPS, ROA and SGR all have positive effects on STR with coefficients 0.01104, 0.028652, 0.030068 and 0.046525 respectively). However, only one of these effects (MCAP with p value = 0.0411) is statistically significant. The effect of the others EPS, ROA and SGR is not statistically significant due to their probability values (0.0611, 0.0861, 0.4488 and 0.1065 respectively). On the other hand, LEV and CUR have negative effects on STR with coefficients -0.005218 and -0.004854 respectively). Again these effects are not statistically significant as revealed by their probability values (0.1206 for LEV and 0.9929 for CUR). While MCAP, EPS, ROA and SGR agree with the *a-priori expectation*, LEV and CUR contradict it.

Notwithstanding, the R^2 of 0.865855 shows that about 87% of the behaviour of STR is explained by the explanatory variables while the remaining 13% is explained by other variables outside model 3.4. The *F*-Statistics is 33.56412 with a probability of 0.0000 showing that model 3.4 is statistically reliable to explain the relationship between the characteristics of manufacturing sector firms in Nigeria and their stock returns.

These results affirm the position of the Capital Assets Pricing Model (CAPM) that stock price, and by implication, stock return is determined by firms based (systematic) risks

Objective 3: Comparative Analysis

The third focus of this research is to compare the effects of firm level characteristics on the stock returns of financial with those of manufacturing firms in Nigeria. This comparison is made in Table 4.7.

Table 4.7: Comparative between financial and manufacturing sector firms' results

Dependent Variable: STR Method: Panel Least Squares						
Variable	Financial sector firms (Fixed Effect)			Manufacturing sector firms (Fixed Effect)		
	Coefficient	Prob.	Remark	Coefficient	Prob.	Remarks
LEV	0.000184	0.4127	Positive, insignificant	-0.005218	0.1206	Negative, insignificant
MCAP	-0.000218	0.8445	Negative, insignificant	0.011404	0.0411	Positive, significant
EPS	0.109350	0.0000	Positive, significant	0.028652	0.0861	Positive, insignificant
ROA	-0.020842	0.0075	Negative, significant	0.030068	0.4488	Positive, insignificant
CUR	0.473097	0.0092	Positive, significant	-0.004854	0.9929	Positive, insignificant
SGR	0.067752	0.4206	Positive, insignificant	0.075762	0.1065	Positive, insignificant
	R^2	0.778456	High	R^2	0.865855	High

	<i>F-Statistic</i>	17.04183		<i>F-Statistic</i>	33.56412	
	<i>Prob(F-stat)</i>	0.000000	Absolutely reliable	<i>Prob(F-stat)</i>	0.000000	Absolutely reliable

Source: Author's computation on E-Views 8 (2020)

Table 4.7 reveals a marked difference in the effects of firm based variables on stock return between financial and manufacturing firms in Nigeria. While three (3) firm level variables (EPS, ROA and CUR) have significant effects on STR of the financial sector firms, only MCAP has significant effect on STR of the manufacturing sector firms. Also, from the Table, out of the six firm level variables studied, only sales growth rate (SGR) has the same effect (positive, insignificant) on STR.

Objective 4: Causality tests

Table 4.8 Comparison of causality results of financial and manufacturing sector firms

Financial sector firms Dependent Variable = STR			Manufacturing sector firm Dependent Variable = STR		
Variable	Prob.	Conclusion	Variable	Prob.	Conclusion
LEV cause STR STR cause LEV	0.9988 0.7132	No causal relationship	LEV cause STR STR cause LEV	0.2627 0.9044	No causal relationship
MCAP cause STR STR cause MCAP	0.2590 0.1932	No causal relationship	MCAP cause STR STR cause MCAP	0.0337 0.6786	Uni-directional causality from MCAP to STR
EPS cause STR STR cause EPS	0.0021 4E-05	Bi-directional causality between EPS and STR	EPS cause STR STR cause EPS	0.0542 0.0095	Uni-directional causality that runs from EPS to STR
ROA cause STR STR cause ROA	0.0167 0.0886	Unidirectional causality from ROA to STR	ROA cause STR STR cause ROA	0.4965 0.3917	No causal relationship
CUR cause STR STR cause CUR	0.7266 0.0003	Unidirectional causality from STR to CUR	CUR cause STR STR cause CUR	0.5760 0.0821	No causal relationship
SGR cause STR STR cause SGR	0.5975 0.5514	No causal relationship	SGR cause STR STR cause SGR	0.5659 0.4529	No causal relationship

Source: Author's computation with EViews 8(2020)

From the results of the causality tests in Table 4.8, it is shown that only the three (3) firm level characteristics that have significant relationship with stock returns of financial sector firms also have causal link with it that is bi-directional, unidirectional and unidirectional causality between EPS, ROA and CUR with STR respectively. On the other hand, among the manufacturing sector firms, two of the firm level variables (MCAP and EPS) have unidirectional causality that runs from them to STR.

5.1 Summary and Conclusions

This study was undertaken to achieve three main objectives. First, the study examined the effect of firm based characteristics on stock returns of quoted financial and manufacturing sector firms in Nigeria. Second, the study did a comparative analysis of the effect of firm based characteristics on stock returns of the financial sector firms with that of manufacturing sector firms quoted on the Nigeria Stock Exchange. Finally, the study examined and

compared the existence and direction (or otherwise) of causality between firm based characteristics on stock returns of the firms on a two sector basis.

Results of the fixed effect model obtained from the panel least squares (PLS) regression show that in the financial sector, leverage and sales growth rate positively affect stock returns but the effect is not statistically significant. Furthermore, market capitalization negatively affects stock return but this effect is also not statistically significant. Earnings per share and liquidity ratio exert positive and statistically significant effect on stock return. Return on assets, on its part, has a statistically significant negative effect on stock return of the selected firms. Earnings per share and liquidity ratio obviously agree with the *a-priori* expectation out of the six firm characteristics examined. The negative and statistically significant effect of return on assets on stock return deserves a special attention as it should naturally affect stock return positively. This negative and significant effect can be attributable to over-investment in assets or assets underutilization. In this case, the return on assets will be sub-optimal, showing absence of good assets management by Nigerian financial institutions. The positive and significant effect of earnings per share and liquidity ratio on stock return is expected as effective management of working capital as well as increased earnings per share will encourage investors to buy more of the firms stock which may bring about a rise in stock price. A rise in stock prices will also translate into higher stock returns.

In the manufacturing sector, however, only market capitalization has a positive and statistically significant effect on stock return and this is expected. For all the other firm characteristics considered, their effects on stock returns are not statistically significant. In essence, these results contradict the *a-priori* expectation of the relationship between firm characteristics and stock returns.

Moreover, comparing the results of causality test of financial sector firms with those of manufacturing sector firms shows that only the firm characteristics that have significant effect on stock return of financial sector firms also have causal relationship with it. That is earnings per share (bi-directional); return on assets (uni-directional to stock return) and liquidity ratio (uni-directional from stock return). In the manufacturing sector, market capitalization has uni-directional causality to stock return) while earnings per share also have uni-directional relationship that runs from stock returns.

This study reveals that the effects of firm based characteristics on stock return can be sector-sensitive. Firm characteristics affect stock return more in the financial sector than in the manufacturing sector. This brings to the fore the need for firm managers and policymakers to develop and implement strategies and policies that are particularly suitable for different sectors of the economy.

5.2 Recommendation

Based on the findings of this study, the researcher recommends as follows:

1. Apart from macro-economic variables that affect stock prices and returns, firm based characteristics also, to a large extent, affect it especially among financial sector firms in Nigeria. Firm managers should develop strategies that will consistently improve stock return, which determines market capitalization and, to some extent, stock returns. The fact that some firm based characteristics have positive but insignificant effects on stock returns suggests that such firm based characteristics can do better and significantly affect stock returns, hence, the need for management to optimally manage such characteristics.
2. Not all firm based characteristics significantly propel high stock returns. To maximize shareholders' return (especially those who prefer current dividends to a future promise of it), management should focus more on variables that have a causal relationship with stock returns.
3. Financial firms should be wary of overinvestment in assets and its underutilization. The need to acquire is desirable. But this can also cause problems when such assets idle away or the cost of maintaining them eats so much into the revenue of the firm.

5.3 Contribution to Knowledge

Management, as well as investors, are particularly interested in knowing how their investments are doing. To the investor, stock return is one major indicator of the performance of his investment. Stock return is very sensitive to occurrences at the firm level of each organization, essentially because it depends much on earnings and dividends. The relationship between activities within the firm environment and what stockholders eventually get as return on their investment is a topical issue that has attracted much attention in finance. Empirical literature on the relationship between firm based characteristics and stock return have dwelt on the mixed results obtained and the generalization of findings. In addition to confirming the inconsistencies reported in literature, this study contributes significantly to the body of knowledge by comparing the effects on sector basis. The study discovers that the effect of firm based characteristics on stock return of the firms in the financial sector is different from that of the manufacturing sector of the Nigerian economy. Finally, this research contributes to the body of knowledge on the subject of the causality between firm level characteristics and stock returns of quoted firms in Nigeria on sector basis and the direction of such causality.

References

- Adedoyin, A. O. (2011). Share price determinants and corporate characteristics. MSc *Dissertation*, Department of Accounting, College of Development Studies, Covenant University, Ota, Nigeria.
- Ahmad, H., Fida, B. A. & Zakaria, M. (2013). The co-determinants of capital structure and stock returns: Evidence from the Karachi stock exchange. *Lahore Journal of Economics*, 18 (1), 81-92
- Basu, S. (1997). The conservatism principle and the asymmetric timeliness of earnings. *Journal of Accounting & Economics*, 24 (1), 3-37
- Black, F. (1972), Capital market equilibrium with restricted borrowing. *Journal of Business*, 45, 444-455.
- Black, F. Jensen, M. & Scholes, M. (1972). The capital asset pricing model: some empirical tests, in *Studies in the Theory of Capital Markets*, Praeger, New York, 79- 121
- Chambers, N., Sezgin, F. H. & Karaaslan, B. (2013). An analysis of the effect of capital structure and the beta coefficient on stock returns: a case study of the Istanbul stock exchange's manufacturing industry. *International Journal of Business and Social Science*, 4 (7), 45-60
- Drew, M. E. (2003). Beta, firm size, book-to-market equity and stock returns. *Journal of the Asia Pacific Economy*, 8 (3), 354-379
- Fama, E. F. & French, K. (1992). The cross-section of expected stock returns. *Journal of Finance*, 47, 427-465.
- Hamed, G & Prahalad, G. K (1994). *Competing for the future*. Harvard Business School, Boston
- Idris, I. & Bala, H. (2015). Firms' specific characteristics and stock market returns (Evidence from listed food and beverages firms in Nigeria). *Research Journal of Finance and Accounting*, 6(16), 188-200
- Kisengo, Z. M., Kombo, H. (2012) Effect of firm characteristics on performance of the microfinance sector in Nakuru Kenya. *International Journal of Science Research*. 3(7), 122-132
- Kogan, L. & Papanikolaou, D, (2012). A theory of firm characteristics and stock returns: The role of investment-specific shocks, *NBER Working Paper No. 17975*
- Kotlar, J., De-Massis, A., Wright, M. & Fretini, F. (2018). Organizational goals: Antecedents, formation processes and implications for firm behaviour and performance, *International Journal of Management Reviews*, 20(1), Retrieved from: DOI: 10.1111/ijmr.12170
- Lintner, J. (1965). The valuation of risk assets and the selection of risky investment in stock portfolios and capital budgets. *Review of Economic Statistics*, 47, 13-37.
- Mgeni, T. O. & Nayak, P. (2016.) Impact of structural firm characteristics on business performance of SMEs: Evidence from agribusiness firms in Dar Es salaam, Tanzania. *Arabian Journal of Business Management Review*, 6, 246.
- Myers, S. C. & Majluf, N. S., (1984). Corporate Financing and Investment Decisions when firms have information that investors do not have. *Journal of Financial Economics*, 13(2), 187-221.
- Okafor, C. (2007). Organizational characteristics and performance in Nigerian quoted companies. *Research Journal of Business Management* 1(1), 37-49
- Okoro, E. G. & Stephen, E. A. (2014). Determinants of stock price movement in Nigeria (Evidence from the Nigerian stock exchange). *Journal of Economics and Sustainable Development*, 5 (3), 101-118
- Olowoniyi A. O & Ojenike J.O. (2012). Determinants of stock return of Nigerian-listed firms. *Journal of Emerging Trends in Economics and Management Sciences*, 3(4), 389-392
- Prombutr, W. & Phengpis, C. (2019). Behavioural-related firm characteristics and risks and determinants of stock returns, *Reviews of Accounting and Finance*, 18(1), 95-112

- Shafana, M. A., Rimziya, A. L & Jariya, A. M. (2013). Relationship between stock returns and firm size, and book-to- market equity: empirical evidence from selected companies listed on Milanka Price Index in Colombo Stock Exchange, *Journal of Emerging Trends in Economics and Management Sciences* 4(2):217-225
- Sharpe, W. F. (1964). Capital asset prices: A theory of market equilibrium under conditions of risk. *Journal of Finance*, 18, 424-447.
- Solomon, E. & Weston, F. (1963). *The Theory of Financial Management*, New York: Colombia University Press
- Tahir, S. H., Sabir, H. M., Alam, T. & Ismail, A. (2013). Impact of firms' characteristics on stock returns: a case of non-financial listed firms in Pakistan. *Asian Economics and Financial Review*, 3 (1), 51-61
- Uwubanmwun, A. E. & Obayagbona, J. (2012). Company fundamentals and returns in the Nigerian stock exchange. *JORIND*, 10 (2), 52-66.
- Yang H., Ryu, D. & Ryu, D. (2017). Investor sentiment, asset returns and firm characteristics: Evidence from the Korean stock market, *Investment Analysts Journal* 46(2), 132-147



The Influence of Investment Decisions and Funding Decisions on the Value of Companies with Ownership Structure as Moderated Variables in Manufacturing Companies Listed in Indonesia Stock Exchange (BEI)

Aqimissolati¹, Sulastri², Isnuhardi³, Agustina Hanafi⁴

¹ Student, Magister of Management Science, Faculty of Economics, Sriwijaya University.
Email: aqimi_keke@yahoo.co.id

² Lecturer of Magister of management Science, Faculty of Economics, Sriwijaya University
Email: sulastri2310@gmail.com

³ Lecturer of Magister of management Science, Faculty of Economics, Sriwijaya University
Email: isnurhadi2020@gmail.com

⁴ Lecturer of Magister of management Science, Faculty of Economics, Sriwijaya University
Email: tinahanafi@ymail.com

Abstract

Introduction: This study examines the effect of investment decisions and funding decisions on firm value with institutional ownership as a moderating variable. In this study, investment decisions are measured by Current Asset to Total Assets (CATA) and Fixed Assets to Total Assets (FATA) while funding decisions are measured by Debt Equity Ratio (DER), institutional ownership is measured by (INST) and company value is measured by EV / EBITDA. **Purpose:** Analyzing the influence of investment decisions and funding decisions on the company's value in the manufacturing sector listed on the Indonesia Stock Exchange in 2014-2017. **Results:** The results showed that there was a positive and significant effect between CATA and DER on EV / EBITDA, while FATA had no effect on EV / EBITDA. **Conclusions:** The study was conducted on companies listed on the Indonesia Stock Exchange in the period 2014 to 2017. This study used as many as 87 manufacturing companies that met the criteria of sampling. This study was analyzed using multiple regression analysis and interaction tests and study also found that INST can strengthen the relationship between CATA and EV / EBITDA, weaken the relationship of DER and EV / EBITDA, and INST does not moderate the relationship between FATA and EV / EBITDA. The results of this study can be used by investors as a material consideration in terms of investment decisions and funding decisions, especially in manufacturing companies in Indonesia. Investors can choose a company that has good financial decisions and an appropriate portion of institutional ownership.

Keywords: Current Asset to Total Assets, Fixed Asset to Total Assets, Debt Equity Ratio, Institutional Ownership, Multiple EVs

INTRODUCTION

An agency in establishing a company must have a clear purpose. The company's goals include getting maximum profit, wanting to prosper the owner of the company and optimizing the value of the company that can be seen from the price of its shares. Company value reflects the current value of future desired income and indicators for the market in valuing the company as a whole (Kusumadilaga, 2013). Carrying out financial management functions is something that can be done to achieve company goals. The optimal combination of management decisions can optimize the value of the company which will affect the prosperity of shareholders.

The market value of a company's shares plus market value is the value of the company. Where there is an amount of debt from the total equity, it can reflect the value of the company (Fama, 2013). Based on the research of Khalisa Rahmina (2016), there are several factors that can affect the value of the company, so that the corporate ownership structure consists of institutional ownership and managerial ownership. The optimization of company value can be done through the implementation of financial management, where one financial decision taken will affect other financial decisions and the impact on company value (Fama & French, 2018).

The manufacturing industry sector records the investment value of US \$21.6 billion throughout 2017 with a total of 256 projects. Compared with other sectors, the processing industry becomes the largest contributor to the total value of investment entered into Indonesia Seniali US \$42.6 billion or grew 23.7% compared to the previous year. I Gusti Putu Suryawirawan, director general of Resilience and development of international industrial Access (KPAII) of the Ministry of Industry (Kemenperin), delivering the growth of the manufacturing sector experienced a significant increase. This is achieved by the increase in product demand both domestically and globally (Bisnis Indonesia, 2018).

Manufacturing company is a large scale company when compared with other companies so it can do comparisons between companies one with other companies. Manufacturing companies also have stocks that are resistant to economic crises. This is because most of the manufacturing products are still needed, so it is very small likely to suffer losses (Devi,2016).

Decisions that can affect the value of the company are investment decisions and funding decisions, doing investment activities is the hardest decision for corporate management because it will affect the value of the company (Vranakis and Prodromos , 2012) and funding decisions is a very important decision for the company because it concerns the acquisition of funding resources for operational activities and for operational activities and financing the Company's investment activities and to achieve The company's objectives, the principal has handed over the management of his company to the manager. The manager is given power by the shareholders to make decisions to increase the shareholder's wealth (Arby, 2015). This often poses a conflict of interest known as agency theory.

Previous research according to Manurung (2013), the investment decision will impact the company's performance in the long term while management has enormous freedom in the company's cash usage. Realizing this then some researchers try to develop a signaling model where capital investment is a signal that the manager can use indicates that the company has high performance prospects reflected through the value of the company.

The prosperity of shareholders can be reached by maximizing the current value of the company. Maximize the prosperity of shareholders of all shareholders ' profits expected to be gained in the future by maximising the current value. The prosperity of shareholders will increase when its share price increases. If the company performs a speculative investment, there is a tendency for the price to fall because the risk of business is getting bigger. Thus, the higher the stock market price means the prosperity of shareholders is increasing (Brigham and Houston, 2013).

The value of the company is often a reference to the shareholders before they invest in a company because the higher the value of the company, the welfare of the company's owners will be higher (Ansori & Denice, 2012). To obtain a high stock market price is not detached from the decisions taken by shareholder parties especially the

financial decision where Jensen & Mecklin (2016), explained that to maximize the value of the company not only value Equity is to be considered, but also all financial claims such as debts, warrants, and other preferent stocks.

Optimizing the value of the company can be achieved through the implementation of financial management, where a financial decision is taken will influence other financial decisions and impact on the value of the company (Fama & French, 2018). According to Hasnawati (2015), financial management regarding the completion of important decisions taken by the company, an optimal combination of the three will maximize the value of the company, among others, investment decisions and funding decisions and proprietary structures.

The decision that could affect the company's value is one of the investment decisions. Conducting investment activities is the hardest decision for the management of the company because it will affect the value of the company (Vranakis and Prodromos, 2012). The purpose of the investment decision is to gain a large profit with a risk that can be managed in hopes of optimizing the value of the company (Afzal and Abdul, 2012). Investment decisions are decisions that reflect future investments (investment opportunity), namely through the introduction of new products or expansion of old products, equipment replacement or building, research and development, and exploration. The implications for companies are companies must plan to make investment decisions through the introduction of new products or the expansion of old products, equipment replacement or building, research and development and exploration (Husnan, 2012).

Previous research that is in line with this has been done by the researchers, resulting in various differences and equations in the results of research samples. Xun Li and Zhenyu Wu (2018), found the result that there was a significant positive relationship between the research variables on the company's value, while in the Razali Haron (2018) influential investment decisions were not significant between the variables Company's research and value.

Based on research results of researchers J. Christopher Hughen, Peter P. Lung (2017) showed that analysis conducted in his research considers no loss of value impairment between asset value and stock ownership structure against value The company is in its prokable use EV multiple. This is in comparison to the research conducted by Norman Wong (2017) which demonstrates a significant influence between the value of assets and investments as well as the structure of ownership of the value of the fund.

The conditions that have been exposed are the primary consideration of researchers to select the manufacturing sector as a research object. On the Indonesian Stock Exchange (IDX) registered 150 manufacturing companies. Researchers use the Puposive sampling method to focus on 87 manufacturing companies located in IDX. This period of research was conducted between 2014-2017, with the reason that the period is closest to the time of research, availability and completeness of data in this period is also one of the electoral variables Period.

The purpose of this research is to seek empirical evidence by analyzing the influence of investment decisions and funding decisions on the company's value in manufacturing and ownership structures as a moderation variation listed on the Exchange Indonesian securities in 2014-2017.

Table 1. Average investment decisions, funding decisions, ownership structure and company value in the manufacturing sector 2014-2017

Remarks	Year			
	2014	2015	2016	2017
CATA	13.92	13.83	13.55	13.63
FATA	10.32	9.73	8.55	10.06
DER	0.99	1.02	0.95	0.90
KI	0.51	0.71	0.56	0.53
EV/EBITDA	3.58	4.32	3.39	3.73

Source: www.idx.co.id (Processed by researchers, 2019)

The average investment decision that was proscribed with the Current Asset to Total Asset Ratio (CATA) fluctuated from 2014 to 2017 that there was a decline in investment decisions annually beginning in 2014 to 2016,

however There was an increase in 2017 by 0.59% while the investment decision in Fixed Asset to Total Assets (FATA) had fluctuated from the year 2015 to 2016 and the average funding decision that was proscribed with the Debt Equity Ratio (DER) showed that the funding decision from 2014 to year 2015 increased 3.03% despite a decline of 6.86% in 2016 and a decrease in the amount of 5.26 in the year 2017. The ownership structure that is proscribed with the percentage of institutional ownership (KI) is also subjected to significant fluctuations and the average data of the company's value is proscribed with Enterprise Value/Earning Before Interest, Tax, Depreciation, and Amortization (EV/EBITDA) in the table above showed that the increase in the year 2015 of 20.39%, then a decline in 2016 as much as 21.34% but there was an increase in the back of the year 2017 of 10.2%.

1. THEORITICAL REVIEW

Signalling Theory

Signal theory is one of the efforts that managers make to maximize the value of the company. The signal theory according to Brigham and Houston (2013) is an action taken by the management of the company that instructs investors on how management views the company's prospects.

The signal theory explains why the company has the urge to provide financial reporting information to external parties. The company's encouragement to provide information because there is an asymmetrical information between the company and outside parties because the company and outside parties because the company knows more about the company and future prospects from the parties (Investor and creditor) (Jusriani, 2013).

This signal theory is also reinforced by the opinions of Ikenbery et al (2017), explaining the signaling theory of breakdown of stocks using asymmetric explanation of information. Management has more information about the company's prospects than the outside parties, i.e. investors. The breakdown of stocks is an effort to attract the attention of investors, giving signals that the company has a good condition. Based on signaling theory, the company's performance is a factor that motivates the company to make stock resolution decisions. This is because the market responds positively to signals where the signals are about the future. Signals given by companies whose past performances are not good will be trusted by the market.

Signal theory is one of the efforts that managers make to maximize the value of the company. The signal theory according to Brigham and Houston (2013) is an action taken by the management of the company that instructs investors on how management views the company's prospects. Companies with profitable prospects will try to avoid the sale of stocks and strive for any new capital needed in other ways, including the use of debts that exceed the target capital structure.

Agency Theory

Agency Theory is a model used to describe the problem between management and owners. The agency's theory according to Brigham and Houston (2013) is a relationship where managers are empowered by the stockholders.

The main principle of agency theory is that there is a working relationship between the authority of the owner or the shareholder with the agent who is the manager, in the form of cooperation contract (Primasari, 2014). Agency problems arise because there is a conflict of disagreements (interests) between the owner (principle) and the management (Siallagan and Machfoedz, 2016).

Jensen and Meckling (1976) argue that agency relationship is a relationship where the owner of the company entrust the management of the company by another person that is the manager (agent) in accordance with the interests of the owner (principle) with Delegate several decision-making authority to the agent. The manager in running the company has the obligation to manage the company as mandated by the principle of increasing the principal prosperity by increasing the value of the company, in return the manager (agent) will be Bonuses or other compensation.

Management as a manager of the company has more information about the company, know more about internal information, and know the prospects of the company in the future compared to the owner or shareholder, therefore the manager obligation to provide information or signals about the company's condition to the owner (scout, 2017). But the information submitted sometimes does not correspond to the actual company's condition. These conditions are known as unsymmetrical information or information asymmetry. In fact, in carrying out its obligations the manager has another purpose that is concerned with their own interests, making the most profit to improve their welfare, so that in the end Creating a conflict of agency, which is a conflict of interest between the management (agent) with the owner or the principle (Haruman, 2017).

Investation decision

Investment decisions are decisions regarding the investment in the present to get a return or profit in the future.

Investments are expected to provide a higher level of return (internal rate of returns) than the cost of capital, said to be profitable. The higher the profit rate resulting from the company's investment activities, it will increase the stock price of the company. Higher stock prices have an impact on the company's increased value (Fama, 2015).

In determining the investment decision, prospective shareholders as principal see the opportunities that will be obtained from investing in a company. In addition, prospective shareholders will also see the management performance of the company. According to Wahyudi and Pawestri (2016), the value of the company formed through the indicator of the stock market value is strongly influenced by investment opportunities. Investment opportunities are formed from the investor's response to the company's value. This is in accordance with the signal theory stating that investment expenditure gives a positive signal of future friendship growth.

Current Asset to Total Asset Ratio (CATA) reflects the proportion of the company's investments in current assets versus Total assets. To some extent CATA is increasingly higher reflects the better investment decision. The greater the ratio is getting better because it shows the availability of cash, receivables and supplies that are the most liquid current property compared to the total assets owned by the company (Syamsudin, 2017). According to Weston and Brigham (2015) The measurements of this indicator are as follows:

$$\text{CATA} = \frac{\text{Current Assets}}{\text{Total Asset}}$$

Fixed asset to total assets (FATA) is defined as the ratio of fixed assets to total asset. Firdaus (2010), said the fixed assets were assets acquired for use in the company's activities for a period of more than one year, not intended for resale in the company's normal activities, and constitute expenditure A large value or material.

Reviewed from the length of the turnover of fixed assets is an asset that is experiencing the process of turnover in the long term "according to Weston and Brigham (2015) The percentage of fixed assets to total assets was found using the following formula:

$$\text{FATA} = \frac{\text{Fixed Assets}}{\text{Total Asset}}$$

Funding Decision

The funding decision is a decision regarding the source of funds to be used by the company. Funding sources are divided into two, namely internal funding sources and external funding sources. Sources of external funds used by companies are debt and own capital.

The funding that is sourced on the issuance of new stocks and bonds is often referred to as the external funding, while the retained earnings are referred to as internal funding. The funding decision will be related to determining the optimal combination of the use of various sources of funds which can basically be divided into two of them

related to the transfer of Externen because it will lead to the retrieval A decision on the capital structure, i.e. will determine the proporsi between the long-term debt and its own capital. This will be seen in Debt to Equity Ratio of the Company (Husnan, 2013).

This is equivalent to the theory (Brigham and Houston, 2013) stating that the higher the ratio means that the more effective the use of these fixed assets will increase the value of the company, assuming that cash flows from the decision Fixed operations and cash flows from declining investments caused by the purchase of fixed assets for the addition of fixed assets within the company.

A proxy used to measure funding decisions is to use a Debt to Equity Ratio (DER). This ratio shows the comparison between financing and funding through debt with funding through equity. This ratio is usually used to measure the financial leverage of a company (Brigham and Houston, 2012).

According to Brigham and Houston (2012), DER can be calculated using the following formula:

$$\text{DER} = \frac{\text{Total Hutang}}{\text{Total Ekuitas}}$$

Institutional Ownership

Institutional ownership is the proportion of share ownership by institutional investors. Institutional investors are believed to have the ability to monitor management actions better than individual investors. Institutional as a shareholder is considered capable of detecting errors that occur Jensen and Meckling (2013).

Value is created when a company gives returns to its investors exceeding the cost of capital. Value for corporate investors can be achieved only by donating value to customers (Sudana, 2018). One of the new paradigms that develops in management to deal with the global, competitive and turbulent business environment is with the customer value strategy (Sartono, 2013).

The existence of shareholders such as institutional ownership has an important meaning in monitoring management. The existence of ownership by institutional such as manufacturing companies, insurance, banks, investment firms and ownership by other institutions will drive improved institutional oversight ownership more optimally. The monitoring mechanism will ensure increased prosperity of shareholders. Institutional significance ownership as supervisory agents are emphasized through their considerable investment in the capital market. When institutions are dissatisfied with managerial performance, they will sell their shares to the markets (Abeysekera, I. and Guthrie, J. 2015).

According to Smith (2013), the change of behavior from passive to active can increase managerial accountability so that managers will act more carefully in decision-making. The increased institutional activity ownership in monitoring is due to the fact that the existence of significant stock ownership by institutional ownership has increased their ability to act collectively. At the same time, the cost of getting out of their investments becomes increasingly expensive because the risk of stocks will be sold at a discounted price. This condition will motivate institutional ownership to be more serious in supervising or correcting all managers ' behaviour and extending the investment timeframe. Surveillance mechanisms can be done by placing an expert board that is not financed by the company so that its position is not under the supervision of managers. Thus, an expert board can effectively perform its functions to control all managers ' actions.

Managerial work will encourage management to improve its performance, because they also have a company (Dinar and Widanar, 2015). Ross (2014) stated that the larger the management work in the company then the management will tend to try to improve its performance for shareholders ' interests and for its successful importance. With increased performance it will increase the value of the company.

$$KI = \frac{\text{ownership by institutional}}{\text{Total company}}$$

Corporate values

The company's main objective is to maximize the value of the firm (Salvatore, 2011). Maximizing the value of the company is very important meaning for a company, because by maximizing the value of the company means also maximizing the prosperity of shareholders who are the main objectives of the company. The value of the company is the price willing to be paid by prospective buyers when the company is sold.

The value is created when the company returns to its investors exceeding the cost of capital. Value for corporate investor can be achieved only by donating value to Customer (Sudana, 2018). One of the new paradigms that thrive in management to deal with the global, competitive and turbulent business environment is with the customer value strategy (Sartono, 2013).

According to Sartono (2013) The value of the company is the selling value of a company as a business that is in operation. The excess selling value above the liquidation value is the value of the management organization that runs the company. The value of the company is very important because with the high value of the company will be participated by the high prosperity of shareholders. The higher the value of the company describing the more prosperous owners. The company's value will be reflected in its stock market price.

According to Christiawan and Tarigan (2017) There are some concepts that explain the value of the company:

Nominal value is the value listed formally in the company's Articles of association. Intrinsic value is the most abstract concept, because it refers to the approximate real value of a stock as a representative of the value of the company. This value relates to a specific condition where a company should be able to consolidate part or all of its assets and billing bills. The liquidation value can only be used for limited use. The value of the book is a corporate value calculated on the basis of accounting concepts. Market value is often called the exchange rate, is the price that is so from the bargain process in the market. Also known as fair market value, i.e.

Maximizing the value of the company is very important meaning for a company, because by maximizing the value of the company means also maximizing the prosperity of shareholders who are the company's objectives. There are several research concepts:

Values are defined for the specific time and period. Value must be specified at a reasonable price And assessments are not influenced by certain buyer groups.

According to Peter P. Lung (2018), Enterprise Value/Earning Before Interest, Tax, Depreciation, and Amortization (EV/EBITDA) assessed the company by looking for market prices from the left side of the company balance, i.e. equity value and debt value, and then Minus the company's cash position, which is intended to find the net value of the debt. EV size is more fair in valuing reasonable prices (Instrinsik stock value) companies. The relevant EV/EBITDA assesses the operational performance of the company compared to PER because of its EBITDA. This measurement with EV/EBITDA is more popular among analysts because it is very suitable compared between Apples to Apples even between Oranges to Apples, as it is suitable compared between one company with another company that has treatment and different accounting systems (Kaplan and Ruback 2014).

$$EV \text{ Multiple} = \frac{\text{Enterprise Value}}{EBITDA}$$

2. RESEARCH METHOD

The types of data used in this study are quantitative data, a data collection method used in this research is to conduct a documentation study conducted by collecting secondary data related to the variables needed for this research data through the Indonesia Stock Exchange website, www.idx.co.id and the company's official website.

According to the source, the data used in this study is external secondary data, i.e. data that is not directly obtained from the source, but obtained in a form that is collected, processed, and published by other parties outside the Company in question. The data used in this study are the company's publications in the form of financial statements, annual reports and sample company performance summaries during the observation period.

Population is a collection of individuals with predefined characteristics. The company's research population in the manufacturing industry group listed on the Indonesia Stock Exchange in 2014-2017. Samples are part of the amount and characteristics owned by the population (Sugiyono, 2017). In this case the population framework amounted to 150 manufacturing companies and the selection of research samples was based on the purposive sampling method. The criteria used to select samples on this research are as follows.

Table 2. Research Sample Selection Process

No	Criteria	Amount
1.	Manufacturing companies listed on the Indonesia Stock Exchange 2014-2017	150
2.	Manufacturing companies that do not have institutional ownership data from 2014-2017	19
3.	Manufacturing companies which do not have complete reports related to research variable data from 2014-2017	44
Number of Final Samples		87
Observation Year		4
Number of Observations		348

Source: Developed for this research, 2019

Based on the sample selection process above, obtained 87 companies that meet the criteria to be sampled in this study and 348 observations.

This research analyses the influence of investment decisions, funding decisions on the company's value by being examined as a moderation variable in manufacturing companies on the Indonesia Stock Exchange. The variables used in the study were: Investment decision X1 (CATA), X2 (FATA), funding decision X3 (DER), working institutionally Z (KI), and company Y value (EV/EBITDA). The phenomenon occurring in this study can be described through data analysis in the sequence of data gathering, processing data and analyzing data.

The company manufactures as a research agency because the manufacturing company is from a business that is moving in the real sector that has the most number of companies compared from other businesses that are lacte of several industries. Despite the lacte of a wide range of industries, manufacturing companies have similar characteristics. The largest company of liquid manufacturing companies in the number of issuers listed on the Indonesia Stock Exchange in 2014-2017 SKPLBI as many as 150 manufacturing companies.

Independent variables (X) Independent variables are variables that are due to the occurrence or change of dependent variables (Sugiyono: 2013). Independent variables in this study were investment decision variables X1 (CATA), X2 (FATA), funding decision X3 (DER).

Moderation Variables (Z)_Moderator variables are variables that affect (strengthen or weaken) the relationship between independent variables with the dependent (Sugiyono: 2013). The moderation variables in this study are the institutional ownership of Z (KI).

Dependent variable (Y)_Dependent variables are variables obtained from the magnitude of the independent variable. According to (Sugiyono: 2013) A bound variable is a variable that is influenced or which is due to the presence of a free variable. The dependent variables in this study are the company's value (EV/EBITDA) registered in the IDX period 2014-2017.

3. ANALYSIS METHOD

The data that has been collected in the study, is processed using statistical data processing applications, namely Eviews software use multiple linear regression with descriptive research, normality test analysis, multicollinearity test analysis, heteroskedasticity test analysis, autocorrelation test analysis, multiple regression analysis, coefficient of determination (R²), simultaneous regression analysis, individual parameter significant test.

The data analysis methods used in this study use multiple linear regression with the help of Eviews programs. Based on the hypothesis in this study the method of data analysis used is quantitative analysis to calculate or estimate quantitatively from several factors individually – alone or together – equal to variables Related. The functional relationship between a single variable associated with a free variable can be done with multiple linear regression. The method of data analysis in this study uses deskriptive statistics with quantitative data aimed at obtaining a comprehensive picture of the direct or indirect influence between variables in this study.

The classic assumption test in the study used a classical assumption test before testing the hypothesis using multiple regression analyses. Test the classic assumptions to be used in this study include:

Normality Test Analysis

Test data normality is performed to determine whether the residual regression model that is researched is distributed normally or not. A good regression Model is that has a normal or close data distribution. This normality test aims to test whether in a variable regression model bonded and free variables have a normal distribution or not. In this study the normality test was done using the Jarque-Bera method where the data was said to be a normal distribution if the value of significance was greater than 0.05.

Multicollinearity Test Analysis

Then the assumption of normality was met The multicollinearity test aims to test whether a regression model is found to be correlated between free (independent) variables (Ghozali, 2016). In case of strong correlation, there is a problem with multicollinearity to know the presence or absence of multicollinearity in the regression model can be seen from: oth of these sizes indicate each of the independent variables described by another independent variable. So the low tolerance value equals the high VIF value (due to $VIF = 1/Tolerance$). A commonly used cut off value to indicate the presence of multicollinearity is the value of $Tolerance \leq 1.10$ or equal to the value of $VIF \geq 10$. Each researcher must determine the level of colinearity that can still be tolerated. For example the value tolerance = 0.10 equals the level of colinearity 0.95. Although multicholeinearity can be detected with tolerance and VIF values, we still know which independent variables are correlated. (Ghozali, 2016).

Autocorrelation Test Analysis

Autocorrelation can be defined as a correlation between interference variables one with other variable disorders (Ghozali, 2016). The autocorrelation test aims to test whether in a linear regression model there is a correlation between disruptor errors in certain periods with disruptor errors in the previous period. If there is a correlation between disruptor errors, it can be said that in a linear model there is an autocorrelation. The autocorrelation test in this study uses the LM-Test test where there is no autocorrelation if the significance value of Obs * Square is greater than 0.05.

Heteroskedasticity Test Analysis

The heteroskedasticity test aims to test whether in a regression model there is a variance inequality of the residual (error) observation to another observation. If the variance of the residual from one observation to another remains, it is called homoskedasticity, and if different is called heteroskedasticity. A good regression Model is that homoskedasticity does not happen heteroskedasticity (Ghozali, 2016) Heteroskedasticity test is done to test regression model in case of variance inequality from the residual of one observation to another observation. If variance occurs differences then it is called Heteroskedasticity and if the variance is fixed then it is called Homoskedasticity. The Heteroskedasticity test in this study used the White test where there is no heterogeneity if the significance value of Obs * Square is greater than 0.05.

Regression analysis

Regression analysis is essentially a study of the dependency of dependent variables with one or more independent variables with the aim to estimate and predict the average population or average value of dependent variables based on value Known independent variables (Ghozali,2013).

Moderated Regression Analysis (MRA) or interaction test is a special application of linear multiple regression where the regression equation contains interaction elements (multiplication of two or more independent variables) with the following equation formula (Liana, 2013):

$$Y = \alpha + \beta_1 \text{CATA} + \beta_2 \text{FATA} + \beta_3 \text{DER} + \beta_4 \text{CATA} * \text{KI} + \beta_5 \text{FATA} * \text{KI} + \beta_6 \text{DER} * \text{KI} + \hat{\epsilon}$$

Information:

Y = Company Value

α = Constant

β_1 = Regression coefficient for CATA

β_2 = Regression coefficient for FATA

β_3 = Regression coefficient for DER

β_4 = Coefficient Regression moderation for CATA * KI

β_5 = Coefficient Regression moderation for FATA * KI

β_6 = Coefficient Regression moderation for DER * KI

$\hat{\epsilon}$ = Residual Value

Research hypothesis Test

Testing the hypothesized variables in this study with a multivariate regression with a level of profitability ($\alpha = 0.05$). This test is performed to determine whether independent variable changes have an effect on dependent variables or not. The hypothesis of this research will be accepted if there is one among the free variables to have an influence on the bound variables (Ghozali,2013).

Coefficient of determination (R²)

Coefficient of determination testing is used to explain how large variations of dependent variables can be described by variations of independent variables. A R² value that detects 1 (one) means that its independent variables provide almost all the information needed to predict the variation of an independent variable. The coefficient of determination aims to know the magnitude of the influence of variables independent of dependent variables.

Statistical test (F)

Test F statistics are used to measure the goodness of fit of a regression equation or to find out if all the free (independent) variables included in the model have a common influence on the dependent variables (Ghozali, 2016). Hypothetical no (Ho) states that all independent variables included in the model do not have a shared effect

on the dependent variables, whereas H_0 states that all independent variables have an influence to dependent variables.

The acceptance criteria and the hypothesis rejection in test F are as follows:

H_0 rejected if $F_{count} < F_{table}$ of $\alpha = 0.05$: meaning all free variables simultaneously have no significant effect on the bound variables. H_0 received if $F_{count} > F_{table}$ Pada $\alpha = 0.05$: Meaning all variables are free Simultaneously significant effect on bonded variables.

t-statistical test

The T-Statistic test basically shows how much the influence of one individual variable-variables in describing the variation of the dependent variable (Ghozali, 2016). The zero hypothesis (H_0) that you want to test is whether a parameter (β_i) equals zero or the alternative hypothesis (H_a) parameter of a variable is not equal to zero.

4. RESULT AND ANALYSIS

Table 3. Descriptive Research Variable Data

Variabel	Minimu m	Maximu m	Mean	Std. Dev
CATA	10.4200 0		13.614 63	1.3876 55
FATA	7.05000 0	17.52000 14.93000	11.661 15	1.5211 45
DER	0.02000 0	2.410000 0.980000	0.7702 87	0.5182 36
KI	0.01000 0	3.990000	0.3828 38	0.3859 79
EV/EBIT DA	0.01000 0		1.5893 10	1.1208 60

Source: Secondary data processed in years 2019

There are five research variables: Current Asset to Total Asset (CATA), Fixed Asset to Total Assets (FATA), Debt Equity Ratio (DER), institutional ownership (KI), and EV multiple (EV/EBITDA). The minimum value is the lowest value for each variable, the maximum value is the highest value for each variable in the study, the mean value represents the average value, and the standard deviation for each variable in the study.

Shows that the average CATA of a sample of manufacturing companies observed was 13.61, where the standard deviation of 1.39 means that CATA of total assets has a portion of 13.61% compared to the value of total assets. The minimum value of 10.42 at PT Pabrik Kertas Tjiwi Kimia Tbk in 2015 and a maximum value of 17.52 at PT Surya Toto Indonesia Tbk in 2016. Shows that the average FATA of the sample of manufacturing companies observed was 11.66, where the standard deviation of 1.52 means that FATA of total assets has a portion of 11.66% compared to the total value of assets. The minimum value of 7.05 at PT Asahimasflat Glass Tbk in 2015 and a maximum value of 14.52 at PT Duta Pertiwi Nusantara Tbk in 2014. Shows that the average DER of the sample of manufacturing companies observed was 0.77, where the standard deviation of 0.52 means that the DER to equity (equity)) has a share of 0.77%, the DER value is above one, companies tend to use debt as a source of corporate funding. The minimum value of 0.02 at PT Pyridam Farma Tbk in 2017 and the maximum value of 2.41 at PT Sri Rejeki Isman Tbk in 2014. Shows that the average KI of the sample of manufacturing companies observed is 0.38, where the standard deviation is 0.39 meaning that ownership of shares by institutions has a portion of 0.38 %. The minimum value of 0.01 at PT Siwani Makmur Tbk in 2014 and the maximum value of 0.98 at PT Mandom Indonesia Tbk 2015. Indicates that the average EV / EBITDA of the sample of manufacturing companies observed

is 1.59, where the standard deviation of 1.12 means that EV / EBITDA has a portion of 1.59% . Minimum value of 0.01 at PT Indo Kordsa Tbk in 2017 and a maximum value of 3.99 at PT Delta Djakarta Tbk in 2014.

Normality Test Analysis

his normality test aims to test whether in a variable regression model bonded and free variables have a normal distribution or not. In research Anini test normality done using the method Jarque-Bera where the data is said to be distribution normal if the value of significance is greater than 0.05.

Table 4. Normality Test Results

Variabel	Jarque-Bera	Significance	Information
CATA	3,139	0,208	Normal
FATA	4,333	0,114	Normal
DER	1,639	0,440	Normal
EV/EBITDA	5,509	0,064	Normal
KI	5,687	0,058	Normal

Source: Secondary data processed in years 2019

The results of the normality test of each variable indicate the Jarque-fallow significance Jarque-Bera significance is above 0.05 so that it shows that all variables are normally distributed.

It can therefore be said that the data in this research is already a normal distribution. The normality test can also be done using the histogram chart present in the attachment with the result on the histogram chart, indicating the normal distribution pattern is to follow or approach the shape of the bell, so that the regression model meets the normality assumption. The test results of normality based on significance testing and the histogram chart indicate that the data in this study is already under normal distribution.

Multicollinearity Test Analysis

Multicollinearity tests are performed to see the presence or absence of the correlation between independent variables in testing the model of multiple linear regression. A regression Model is good if there is no high correlation between its free variables, because if there is a correlation then the variables are not orthogonal or there are similarities. This test was conducted to avoid partial influences of each free variable against the bound in the decision making process. This test in regression models can be seen by means of the tolerance value and the value of VIF (Variance Inflation Factor). To view the multicholinerity by using Eviews is to see a value of VIF no more than 10.

Table 5. VIF values

Variabel	VIF	Information
CATA	1.271244	Non Multikolinieritas
FATA	1.048163	Non Multikolinieritas
DER	3.495952	Non Multikolinieritas
CATA*KI	3.550862	Non Multikolinieritas
FATA*KI	1.831542	Non Multikolinieritas
DER*KI	5.435282	Non Multikolinieritas
KI	1.386276	Non Multikolinieritas

Source: Secondary data processed in years 2019

Multicollinearity test results on the independent variables obtained tolerance values on research variables above 0.1 and VIF values below 10 so that it can be said there is no high relationship between the independent variables.

Heteroskedasticity Test Analysis

The autocorrelation test aims to test whether in a linear regression model there is a correlation between disruptor errors in certain periods with disruptor errors in the previous period. If there is a correlation between disruptor errors, it can be said that in a linear model there is an autocorrelation. The autocorrelation test in this study uses the LM-Test test where there is no autocorrelation if the significance value of Obs * Square is greater than 0.05.

Table 6. Heteroscedasticity Value

Obs*Rsquared	Significance	Information
32,778	0,3798	Non Heteroskedastisitas

Source: Secondary data processed in years 2019

The above results obtained significance value of Obs * Rsquared is 0.3798 so the value is greater than 0.05 so there is no heteroscedasticity, so it can be said that the regression model does not contain heteroscedasticity symptoms.

Autocorrelation Test Analysis

Heteroskedastitas test is done to test regression model in case of variance inequality from the residual of one observation to another observation. If variance occurs differences then it is called Heteroskedastitas and if the variance is fixed then it is called Homoskedastitas. The Heteroskedastitas test in this study used the White test where there is no heterogeneity if the significance value of Obs * Square is greater than 0.05.

Table 7. Autocorrelation Values

Obs*Rsquared	Significance	Information
3,040	0,2186	Non Autokorelasi

Source: Secondary data processed in years 2019

The above results obtained significance value Obs * Rsquared that is 0.2186 so that the value is greater than 0.05 so there is no autocorrelation. Therefore, this regression model does not have a correlation between the error of the intruder in a certain period with the error of the intruder in the previous period.

Multiple Regression Analysis

In this research hypothesis test used includes; partial test (t-test), and test of coefficient of determination (R2). Multiple linear regression models in this research are shown as follows:

Coefficient of Determination (R2)

The result of the determination coefficient above is 0.281 which can be said CATA, FATA, DER, CATA * KI, FATA * KI, DER * KI and KI moderation together can influence EBITDA of 28.1%.

Coefficient of determination testing is used to explain how large variations of dependent variables can be described by variations of independent variables. A R2 value that detects 1 (one) means that its independent variables provide almost all the information needed to predict the variation of an independent variable. The coefficient of determination aims to know the magnitude of the influence of variables independent of dependent variables. The resulting coefficient of determination above is 0.281 which can be said that CATA, FATA, DER, CATA * KI, FATA * KI, DER * KI and KI moderation are jointly able to affect EBITDA by 28.1%.

Simultan Regression Analysis

The calculated F value is 23,638 and the significance is 0,000 so the calculated F value is greater than the F table and the significance is less than 0.05, it can be concluded that there is a simultaneous influence of the variables CATA, FATA, DER, CATA * KI, FATA * KI, DER * KP against EV / EBITDA.

A statistical test of F essentially indicates whether all the independent variables included in the model have an influence together with the dependencies. When analysis using the F test indicates that all independent variables are a significant explanatory of the dependent variables.

Simultaneous testing aims to determine whether there is a co-influence of the variable independent of the dependent variable. There is an influence jointly between independent variables if the value of F counts is greater than F table and significance is smaller than 0.05. The value of F count is 23.638 and the significance of 0.000 so that the value of F count is greater than F table and the significance is smaller than 0.05, it can be concluded that there are simultaneous influences of the variables CATA, FATA, DER, CATA * KI, FATA * KI, DER * KI against EV/EBITDA.

Individual Parameter Significant Test (Test Statistic t)

T-statistic tests essentially show how far the influence of one independent variable individually in affecting its dependencies variable. T statistical test results can be seen as follows:

Table 8. T Test Results (Partial Test)

Variabel	Koefisien	t count	Significance	Information
CATA	0.324590	5.750867	0.0000	Significant
FATA	0.021494	0.387302	0.6988	Not significant
DER	0.695801	3.588817	0.0004	Significant
CATA*KI	0.207670	2.529766	0.0119	Significant
FATA*KI	-0.147564	-1.472866	0.1417	Not significant
DER*KI	-1.290122	-3.975616	0.0001	Significant
Constanta	-3.665492			
Fcount; Significant = 23,658 ; 0,000				
R Square= 0,2815				

Source: Secondary data processed in years 2019

From the table above, we can get the multiple linear regression equation as follows:

$$\text{EV / EBITDA} = -3,665 + 0,324 \text{ CATA} + 0,021 \text{ FATA} + 0,696 \text{ DER} + 0,208 \text{ CATA} * \text{ KI} - 0,148 \text{ FATA} * \text{ KI} - 1,290 \text{ DER} * \text{ KI}$$

The CATA variable has a value of T count 5.751 and a significance of 0.0000 so that the value significance is smaller than 0.05, so there is a significant partial influence of the CATA variable against EV/EBITDA. This means that CATA has a significant effect on EV/EBITDA. A constantan of -3.665 states that if the independent variable is considered constant, then the company's value (EV/EBITDA) of -3.665.

The FATA variable has a value of T count 0.387 and a significance of 0.6988 so that the value of significance is greater than 0.05, so there is no significant partial influence from the FATA variable against EV/EBITDA. This means that FATA has no significant effect on EV/EBITDA.

The DER variable has a value of T count 3.589 and a significance of 0.0004 so that the value of significance is less than 0.05, so there is a significant partial effect of the DER variable against EV/EBITDA. This means that DER has significant effect on EV/EBITDA.

The CATA * KI variable has a calculate count value of 2.530 and a significance of 0.0119 so that the value of significance is greater than 0.05, so there is a significant partial effect of the CATA * KI variable against EBITDA.

The FATA * KI variable has a value of T-1.473 and a significance of 0.1417 so that the value of significance is greater than 0.05, so there is no significant partial influence of the FATA * KI variable against EV/EBITDA.

The DER * KI variables have a count-3.976 value and a significance of 0.00001 so that the value of significance is greater than 0.05, so there is a significant partial effect of the DER * KI variable against EV/EBITDA.

5. CONCLUSION

This research analyzes the influence of investment decisions, funding decisions on the company's value with the ownership structure as a moderation variable in manufacturing companies on the Indonesia Stock Exchange. Based on the research and results of the analysis that has been done, it can be concluded as follows:

1. Current Asset to Total Asset Ratio (CATA) positively affects the value of Company (EV/EBITDA)
2. Fixed Asset to Total Assets (FATA) has no influence on the value of the company (EV/EBITDA)
3. Debt Equity Ratio (DER) has a positive effect on the company's value (EV/EBITDA).
4. Institutional ownership reinforces the relationship between Current Asset to Total Asset Ratio (CATA) and company value (EV/EBITDA)
5. Institutional ownership does not affect the relationship between Fixed Asset to Total Assets (FATA) and company values (EV/EBITDA)
6. Institutional ownership weakens the relationship between Debt Equity Ratio (DER) and company value (EV/EBITDA)
7. CATA, FATA, DER, CATA * KI, FATA * KI, DER * KI and KI moderation are jointly able to affect EV/EBITDA by 28.1%.

This study analyzes the effect of investment decisions, funding decisions on firm value with ownership structure as a moderating variable in manufacturing companies on the Indonesia Stock Exchange. This research period for four years from 2014 to 2017 with a slight sample of 87 companies from 150 manufacturing companies. This research uses a four-year period with a slight sample of 87 companies from 150 manufacturing companies, because there are some companies that do not publish the complete audited financial reports so that Reduction of the samples needed for research.

The results of this research can be beneficial to enrich the concept or theory that supports the development of science on financial management, especially in relation to investment decisions, funding decisions, institutional ownership structures and Corporate values and can mine research references relating to agency theory and signalling theory.

The results of this research are aimed at the company in managing financial policies and decisions that are investment decisions and financial decisions as well as the institutional ownership structure of the company in enhancing the company's value. The company may consider the financial decisions taken and consider the magnitude of the company's institutional ownership to increase the value of the company.

The results of this research is intended for investors to be used as consideration in terms of decision making investing especially in manufacturing companies in Indonesia. Investors can choose companies that carry out mechanisms of management of companies and companies that have good financial decisions according to government and corporate rules.

6. SUGGESTION

Based on the discussion and conclusion that has been gained on the influence of investment decisions, the decision to fund the value of the company with the ownership structure as a moderation variable in the manufacturing company on the Indonesia Stock Exchange The author gave the following advice

For investors, it is better to invest capital in companies that have good financial decisions and the appropriate share of institutional ownership. For companies, pay more attention to financial decision making and the share of institutional shares in accordance with applicable regulations and benefit the company. For further researchers develop this research by analyzing other factors and adding to the research period.

For the company, pay more attention to the financial decision making and the portion of the institutional share ownership in accordance with the prevailing rules and profitable companies.

For further researchers develop this research by analyzing other factors that Influence the company's value and can provide a appropriate regarding variables that can moderate and influence the other variables.

References

- Abeyssekera, I. and Guthrie, J. 2015, "An empirical investigation of annual –in Sri Lanka", *Critical Perspectives on Accounting*, Vol. 16 No. 3, 151-63
- Almquist, E., & Roberts, K. J. 2000. A "mindshare" manifesto. *Mercer Management Journal*, (12), 9–20.
- Arby, Hanadi Fanny. 2015. *Struktur Kepemilikan, Tipe Kepemilikan an Nilai Perusahaan : Studi Empiris di Bursa Efek Indonesia*. Tesis Program Pascasarjana Universitas Gadjah Mada.
- Arikunto, S. 2015. *Metodelogi Penelitian (edisi revisi)*. Yogyakarta. Bina Aksara
- Arikunto, Suharsini. 2015. *Prosedur penelitian suatu pendekatan praktik*. Jakarta. Aneka Karya
- J. Christopher Hughen, Peter P. Lung. 2017. *The Impact of Not Amortizing Intangible Assets on Valuation Multiples*. *Pacific Accounting Review*.
- Jensen, M.C and Meckling, W.H. 1976. *Theory of the form managerial behavior agency cost and ownership structure*.
- Jogiyanto, Hartono, 2018, *Teori Portofolio dan Analisis Investasi*, Edisi Pertama, BPFE Yogyakarta, Yogyakarta.
- Kusumajaya. 2013. *Pengaruh struktur modal dan pertumbuhan perusahaan terhadap profitabilitas dan nilai perusahaan pada perusahaan manufaktur di BEI*. Tesis Program Pascasarjana Universitas Indonesia.
- Lobo Byron Y. Song. 2017. *Investment Decisions and Bank Loan Contracting* Wenxia Ge Tony Kang Gerald. *Asian Review of Accounting*.
- Lee, C. Rosentein, SN, Rangan, dan Davidson. 1992. *Board Composition and Shareholder Wealth: The Case of Management Buyout*. *Financial Management* 21:58-72
- Miller, M.H. 2012. Debt and taxes. *Journal of Finance*, 32:261-275.
- Modigliani, F. & Miller, M. 1958. *The cost of capital, corporation finance, and the theory of investment*. *American Economic Review*, 48:655-669.
- Modigliani, F. & Miller, M.H. (2013). *Corporate income taxes and the cost of capital: a correction*. *American Economic Review*, 53:433-443
- Myers S.C. 2012. *The capital structure puzzle*. *The Journal of Finance*, 39(3).
- Myers S. & Majluf, N. 1984. *Financing decisions when firms have investment information that investors do not*. *Journal of Financial Economics*, June:187-220.
- Norman Wong. 2017. *Risk management in student-managed funds: Earnings announcements and the collar strategy*. *Managerial Finance*.
- Papers and Proceedings, 42nd Annual Meeting, *American Finance Association, San Francisco, Calif, December 28-30, 1983 (July 1984):575-592*.
- Sartono, Agus. 2013. *Manajemen Keuangan*. Edisi Keempat BPFE : UGM Yogyakarta
- Statistics South Africa. 2018. *Historical CPI indices*. Pretoria: *Statistics SouthAfrica*. <http://www.statssa.gov.za>. Accessed: 15 January 2019.
- Sugiyono. 2013. *Metode Penelitian Kuantitatif Kualitatif dan R&D*. Bandung: Alfabeta
- Tandelilin, E, 2012, *Analisa Investasi Dan Manajemen Portofolio*, Edisi Pertama, BPFE, Yogyakarta. www.idx.co.id.



The Diaspora and the Process of Economic Development in Cameroon

Saidou Baba Oumar¹, Urie Eléazar Jumbo², Salihu Zummo Hayatudeen³

¹Department of Economics, University of Buea, Box 63 Buea, Cameroon. Department of Economics, The University of Bamenda, Box 39 Bambili, Cameroon. E-mail: saidoubou@gmail.com

²Department of Economics, University of Dschang, Box 110 Dschang, Cameroon. Department of Economics, The University of Bamenda, Box 39 Bambili, Cameroon. E-mail: urie.eleazar@yahoo.fr

³Department of Economics, Modibbo Adama University of Technology, Yola, PMB 2076 Yola, Adamawa State, Nigeria. E-mail: salihuzummoh@gmail.com

Abstract

The greener pasture syndrome erupts on the African continent in 1980s, two decades after attainment of independence for most former colonies from the colonial powers. Today in 2020, some forty years after, the syndrome continues to register more disciples from the continent due to economic hardships that threaten a greater portion of her population. Consequently, the movement of people towards the promise land from poor to rich countries across the world amplifies to the extent that some industrialised countries find themselves invaded by emigrants of all types. In Cameroon for example, this type of migration concerns the intellectuals who are not employed or those who are underemployed in the country. Cameroonians of this category often cross the national boundaries to Europe, Canada, United States [US] and as of 1990 South Africa [SA] to pick up jobs that can fetch them better salary package than what is offered at home. This paper employs the simple descriptive method of data analysis to capture the objectives of the inquiry using simple percentages, tables and diagrams to interpret the data. Besides, the paper generates its data from personal observations and structured interviews with community members and from secondary sources. And generally on arrival to destination, the Diaspora people team up in form of social ethnic groups or village associations to reflect on the problems besetting their relations and give a helping hand towards alleviating the living conditions of their people back home. Results of the paper reveal that these Diaspora alliances have rendered immense services to their respective communities as regards poverty mitigation in families, construction of private houses, and provision of social infrastructures such as first aid centres, school equipments and water supply points, on one hand. On the other hand, they have also inflicted severe harms to their communities back home. Thus, the paper recommends that the Government of Cameroon [GoC] recognises and incorporates the Diaspora potentials into the country's development strategies so as to accelerate its participation to the economic development equation and process of the economy.

Keywords: Community, Development, Employment, Migration, Poverty, Remittance

JEL: H31, O10, E24, F22, P36, F24

1. Introduction

Migration occurs in various forms and people migrate under different circumstances. African migrants are generally involved in intra country migrations between rural areas or from rural areas to urban centres, inter country migrations within the continent and overseas migrations between continents of the world. The economic

motive is mainly perceived as the common denominator to such movements even though isolated cases of political prosecution exist in some countries. In the past, the displacements of Africans were unplanned and mainly influenced by the slave trade. History retains that in the 17th century, this trade played a major role in relocating the Sub Saharan Africa [SSA] population to the large scale plantations of Americas. At that time, the folks who departed Africa under this form of trade for Americas were expected to serve economic interests of their masters or exploiters only.

Nowadays, most African migrations are calculated in advance with a specific target. This implies that migration in search of the promise land continues to remain a reality on the African continent. However, the nature of the current exodus is mixed rather than unique compared to what it was in the slave trade era. The global estimate for contemporary migration between countries is estimated at some 125 million people per annum (De Montclos, 2003). In 2007, worldwide international migration number stood at 258 million or 3.4% of the world population (United Nations Department of Economic and Social Affairs [UNDESA], 2017). For the period 2000-2007, the number of international migration to Africa augmented from 15 million to 25 million (*Nations Unies* [NU], 2018:43), while migration to most industrialised countries [MICs] inflicts to Africa an annual average loss of 70 thousand skilled personnel (Commission for Africa [CA], 2005:27). The destination countries for the African Diaspora [AD] in general and Cameroonians in particular are Europe, Canada, US and recently from 1990 SA where there seems to exist greener pastures for the adventurers. The explorers of these new horizons hope to secure jobs that can fetch them better salary package than what is offered back home.

The type of migration involving Africans these days is especially tailored towards home benefit migration [HBM] as opposed to home cost migration [HCM]. HBM system consists of emigrants who are in permanent contact with their native soil and play a part in its development from various angles. On the contrary, HCM scheme encompasses emigrants who have lost contact with their origin and cannot directly participate in the advancement of their forefathers' land. HBM scheme pulls together the unemployed or underemployed intellectuals from the country of origin who, generally on arrival to destination, unite in form of social ethnic groups or village associations to reflect on the problems besetting their communities back home in order to proffer lasting solutions. From time to time, these Diaspora alliances render economic, political and social services to their home communities.

Even so, many less industrialised countries [LICs] seem to ignore the contributions of these emigrants and misunderstand the advantages of having them in other countries. The case of government neglect towards the migrants living abroad becomes fascinating, especially when the emigrants are critical of the government's policies at home. This has been denounced by most AD living abroad, including the Cameroonian Diaspora [CD]. On flimsy excuses fostered by the fear of loss of power, leaders in the countries of departure treat such vocal critics as enemies and a permanent threat to their administration. Among these critics, some have been prosecuted and assassinated abroad by mercenaries of their countries of origin. *Radio France Internationale* [RFI] (2019) reports the assassination on 16 May 1998 of Rwanda former Minister of Internal Affairs, Seth Sendashonga in Nairobi, Kenya, while Bornman (2018) mentions the assassination on 1 January 2014 of Rwandan dissident and former Chief of Intelligence, Colonel Patrick Karegeya in his room at the Michelangelo Hotel in Sandton, Johannesburg [JHB], SA and the survival of a number of assassination attempts of former Rwanda Chief of Army, General Faustin Kayumba Nyamwasa in JHB, SA by the Rwandan regime of President Paul Kagame. Also, Rolley (2019) of *RFI* reminds that on 15 November 2019 in an address to the nation, President Paul Kagame openly warned vocal critics of his administration considered by him as the enemies of Rwanda and solemnly reiterated over *RFI* his determination to deal with them summarily wherever they may be.

In 2003, worldwide gross inflows of remittances amounted to US\$200 billion, of which US\$58 billion went to MICs and US\$142 billion to LICs (Ghosh, 2006:14). In 2005, worldwide remittances were estimated at over US\$232.3 billion (World Bank [WB], 2006:88). In 2004 and 2005, LICs received US\$160 billion and US\$167 billion remittances inflows, respectively (WB, 2006:85). Remittances to LICs have increased substantially during 1990 to reach US\$325 billion in 2010 (WB, 2011 in Mohapatra & Ratha, *s.a*). Recorded remittances sent back home by LICs' migrants reached US\$240 billion in 2007 up from US\$221 billion in 2006 and more than double the level in 2002. The true amount of remittances were more than twofold the level of official

development assistance [ODA] flows to LICs in 2007 (Ratha & Mohapatra, 2007:1). In Europe; some 700 thousand emigrants from Albania remitted about US\$650 million per year, thereby providing 60% of the country's national income. In Latin America and the Caribbean Islands, migrants sent back home US\$30 billion in 2002 and US\$38 billion in 2003. This was more than the sums produced by foreign investment and public aid for development in the region (De Montclos, 2005: 14). More so, the European Investment Bank [EIB] (2006:33) showed that in 2003, remittances from migrants of some Mediterranean countries constituted 9% of gross domestic product [GDP] in Morocco, 5% in Tunisia and 4% in Egypt, 15% in Lebanon, and 22% in Jordan.

The economic contribution of the Diaspora alliances ranges from enhancing the living condition of individual families and construction of private houses to boosting the national income of migrants' country of origin. Between 2000 and 2003, African emigrants to overseas sent some US\$17 billion back home – an amount which exceeds foreign direct investment [FDI] flows for the same period by US\$2 billion (United Nations [UN], 2005 in AllAfrica, 2019). In 2010, official remittances to Africa stretched to US\$40 billion doubling the amount received in 2005 and more than quadrupling the US\$9.1 billion received in 1990 (Ratha *et al.*, 2011:50-51). Furthermore, Somali surveys anticipate that total remittances received from migrants before the 1996 war exceeded US\$800 million per year if commercial transactions and private financial transfers to other Somali communities in the Horn of Africa are taken into account and that out of this amount US\$360 million were private donations to family members. These family donations provided more than 22% of households' resources in the country (WB, 2003:109). In The Comoros, migrants officially send home roughly US\$20 million per year and this sum is equivalent to the state's resources (Guebourg. 1995). In Cape Verde, the number of people living abroad is by far superior to the number of home residents and the remittances from Cape Verdeans in the West remained a major asset to the country's economy, totaling US\$67 million in 2000, US\$72 million in 2001, US\$68 million in 2002 and US\$64 million in 2003. In Lesotho, remittances by migrants attain 50% of the gross national product [GNP], 90% of the value of imports, nearly 1400% of exports in the 1980s (De Montclos, 2005:16, 44). These financial transfers provide 80% of the income of rural households in the country (Sembajwe, 1993: 160).

The emigrants' community abroad also plays a political role both in their countries of origin and destination. The Somali Diaspora [SD] plays a significant role in her war ravaged country, and is involved in various aspects of the peace process. Similarly, Cape Verdeans abroad pave the way for the demise of the one party system in 1991 and also sustain the fight for the country's independence from Portugal. Albeit these honours, ADs have also endorsed troublesome activities to their countries of origin. Some have overtly supported armed conflict and illegal businesses. With regard to armed conflicts for example (De Montclos, 2005: 28, 43), the Eritrean embassies in MICs received financial support from their emigrants to sustain the country's border hostilities with Ethiopia in 1999 (Koser, 2002). Conversely, ADs have used unofficial remittance networks to introduce fake currencies, elude exchange controls and finance illicit activities such as prostitution, selling of drugs, smuggling of people and contracting deals in armaments across boundaries. For instance, only 16% of the Senegalese *Modou-modou* remittances pass through Western Union (De Montclos, 2005:44). Likewise; close to 67% of Nigerian emigrants in US remit money home through family members or associates who are travelling back home (Egbe & Ndubisi, 1998), while in Cameroon 87% of migrants participate in the *Njiangi* [Self Help Credit Associations: SHCAs] as the most effective way to remit money home (Weiss, 1998). Sum up, it was for instance observed that in SSA, official financial aid movements oscillate significantly over years, whereas remittances remain steadier than both ODA and FDI from year to year. Therefore, there is the need to appreciate the effects of remittances on recipient countries.

However, the literature on remittances offers little evidence about the contribution of the Diaspora in the area of social infrastructures such as first aid centres, school equipments and water supply in Africa. This article seeks to fill this vacuum at a time where governments across the world are instructed by the Bretton Woods's institutions to align their policies with the globalisation agenda and are alongside cut in the cobweb of the international financial crisis. Consequently, the globalisation agenda requirements and the 2008 international financial and economic crisis constitute two major challenges for the developing world. The first test emerges as a result of a collective fear for the outbreak of a potential disaster around the globe if adequate measures are not taken in

advance to enhance the condition of people living on the planet given the demographic explosion of the world population that feeds on fast depleting natural resources. The globalisation agenda identifies 11 millennium development goals [MDGs] as major areas of concern in the 21st century for man's development on earth. Goal 7 of the agenda in its target 10 undertakes to offer access to improved water and sanitation services to people by halving the proportion of people without access to clean water and sanitation services by 2015 based on the 1990 thresholds. As a result, CA (2005) reports that Africa received assistance worth US\$25 billion, only 0.1% of high income countries GDP from donor countries to enforce the globalisation agenda. Yet the progress report on the agenda shows that Africa requires double that amount by 2010 in order to meet MDGs. On the other hand, the second test relating to the financial and economic crisis is unplanned and has also affected donor countries. The fundamental question that arises now is to know what strategies governments have designed and how far have they gone to attaining the golden objective of making basic social amenities accessible to the vast majority of mankind. The case of Cameroon retains the attention in this paper.

This study stands to benefit many groups. First, the study anticipates creating awareness on the process of social infrastructures provision and distribution to the public. Second, the study exposes the dynamism of CD in the nation building process. Third, it underscores the challenges of CD towards achieving this process. Therefore, the main objective of the paper is to examine the contribution of the Diaspora to the process of economic development in Cameroon. This objective is achieved through the following specific aims by:

- Appraising the Diaspora developmental projects realised,
- Scrutinising the problems and concerns of the Diaspora, and
- Counselling on better ways of encouraging economic development process in Cameroon.

The paper is hooked on 5 sections. Following the introduction which focuses on the background and objectives in Section 1, the theoretical framework on economic development is discussed in Section 2. The methodology of the study is explained in Section 3. Section 4 trails with the data analysis and discussion of results of the study. The conclusion, recommendations and shortcomings of the paper are presented in Section 5.

2. Theoretical Framework

Some time ago, economic development was used to mean economic growth and development. After witnessing situations of significant economic growth rate and physical expansion in some economies across the globe, enameled with miserable living conditions of people, a distinction between economic development and the other two rival concepts became obvious as follows. Economic development occurs when the society enjoys an economic condition of significant reduction in income distribution inequality, the rates of unemployment and poverty or in at least two of the three social vices. Economic growth is an economic state of simple annual rise of at least 5% in the national income of an economy, which may not automatically filter down to the ordinary people in the economy. Development describes an expansionary phenomenon taking place in a person, family, an institution or an area as a result of imperceptible or discernible actions. Consequently, Pieterse (2010:7) argues that economic development is a comprehensive cure for advancement and triumph of mankind prosperity that takes into account wealth increase, resources control, industrialisation, economic growth, social and political modernisation, human opulence, broadening of people's choices, and globalisation through deregulation, liberalisation, and organisational rebirths. Nevertheless, economic growth is essential for the attainment of economic development.

2.1. Theories of Economic Development: 1500s-1940s

The trade restriction model or mercantilist school of thought [MST] was the first model of economic development conceived to understand mankind progress on earth. It influenced the activities of man from 1550 to 1775 and viewed economic affluence of an economy as the attainment of steady balance of trade of the economy through trade monopolies, implementation of protectionism via tariffs and egoistic laws, undertaking of exchange in gold and silver, and conquest of colonies to control industrial raw materials. Overall, the running of these activities stimulated the European industrial revolution which freed Europe from the yoke of feudal society. De Monchrétien (1891), Steuart (1767), and Mun (1664, 1621) are the pioneer mercantilist authors.

Nonetheless, the freedom MST secured for communities restricted production, productivity, growth and the overall wellbeing of the society for only few individuals benefited from the trade gains at the detriment of the masses.

The criticisms waged against MST led to the proposal of an alternative model of economic development by Smith (1776)—the free trade model [FTM], which conquered the economic life of the world from 1776 to 1780s. FTM encouraged trade with no restrictions, division of labour, specialisation, limited government interference, and rivalry to boost up the creation of goods and amenities for the enhancement of people's living standards in the society. Yet the ambitious plan of the model for humanity confronted a major human challenge, a discrepancy between the natural resources at disposal and the number of people to feed on them, which preoccupied everybody in the society. Upon meditation on this worry, Malthus (1798) developed the resources constraint model [RCM] of economic development, underlining that human posterity is endangered by desires and extravagances for the world population is increasing in geometric progression, whereas food production is growing in arithmetic order.

The teachings of RCM gained currency from 1780s to 1790s before conceding to Ricardo (1817)'s comparative advantage model [CAM] of economic development and the *laissez-faire* model [LFM] of economic development of Menger (1876), Walras (1899), Marshall (1890), and Jevons (1871) who consider market mechanisms and marginal state interference in the economy as the paramount alternative for effective and efficient distribution of wealth among rival productive economic actors. LFM bases its argument on the assumptions that markets are perfect, prices adjust automatically through the forces of demand and supply, consumers are sovereign and economic agents are selfishness when making decision. The argument of LFM earned universal respect across the globe till 1929 when the world economy got asphyxiated by the great depression before admitting the limits of the market forces to adjust spontaneously in the long run. The Keynesian economics model [KEM] of economic development proposed by Keynes (1936) argues that these limits reveal the key role of state intervention through the implementation of fiscal or monetary policies in stabilising the economy against undesirable and uncertain economic situations that can take the economy hostage at any moment.

2.2. Theories of Economic Development: 1940s-1980s

The period 1940s–1980s was dominated by the linear stages models [LSM] of economic growth such as the Harrod-Domar model [HDM] developed autonomously by Harrod (1939) and Domar (1947) and Rostow's stages model [RSM] designed by Rostow (1960), as well as the structural change models [SCM] of economic growth such as the Lewis's theory of economic development [LTD] of Lewis (1954) later on extended by Ranis & Fei (1961), Jorgenson (1961) and Fei & Ranis (1964), and the patterns of development empirical analysis [PDA] of Chenery & Syrquin (1975), Chenery & Taylor (1968), and Chenery (1960). Being an expansion of HDM, the Solow growth model [SGM] put forward by Solow (1956) adds technology and labour input to the growth function. Consistent with SGM, economic growth of an economy depends on either increase in the stock of capital (Savings and investments), increase in quantity and quality of labour (Population growth and education) or technological improvements (Labour saving, capital saving, labour augmenting, capital augmenting). The model explains that in the short run economies with higher rates of savings (MICs) grow faster and tend to converge to higher per capita income levels as opposed to economies with lower savings rates (LICs).

These models perceived economic growth as a sequence of successive stages through which all economies must pass in order to grow. The main assumption of the theories is that the accumulation of the right amount and combination of savings, investments, foreign aids and the appropriate policies were the necessary components to trigger economic development. By joining the available human and physical resources with right domestic and international policies, the desired structural changes towards economic development were experienced in contemporary MICs. This can also be achieved in LICs if their internal advantages and the external constraints mirrored to them by MICs as development opportunities in the form of transfer of technology, development assistance or financial aids are handled with caution for most domestic and international decisions inducing economic development are marginally controlled by LICs.

The period 1960s-1980s steered international dependence revolution models [IDRMs] of economic development as alternative to LSMs. Scholars like Rodrik (2008), Stiglitz (2002), Easterly (2001), Wallerstein (1980), Cardoso (1977), Amin (1976, 1974), Galeano (1973), Dos Santos (1973, 1969), Rodney (1972), Franck (1967), Sunkel (1966), Baran (1957), Higgins (1956) and Boeke (1953) fervently defend the ideals of IDRMs in their works. The models were a more radical and political movement that blamed the state of underdevelopment in LICs on the unfair dealings between MICs and LICs in the form of bossy and needy relations through institutional, political and economic rigidities at both the domestic and international levels, presence of dual economies and dual societies in the world. The growing number of independent countries and rise of a class of elites inspired by a sense of collective fate in LICs in 1960s conditioned the rebirth of the theory of economic development across the globe. The false paradigm model (FPM), neocolonial dependence model [NDM], and dualistic development model [DDM] are perceptible in this group.

Whether radical or moderate, the main argument of IDRMs of economic development is that external and internal institutional as well as political constraints are the main factors hindering economic development in LICs, hence the need for new policies such as diversification of employment opportunities, bridging income inequality gaps, eradication of poverty that conform to the realities of LICs rather than the application of sophisticated and imported models from MICs to LICs, revolutionary campaigns of industrial nationalisation and an inward orientation in LICs to get rid of the international and domestic economic control of oppressors, rejection of inappropriate or irrelevant concepts and models of capital-output ratios, savings, investment ratios and growth rates of GDP of MICs to adopt concepts and models applicable to LICs' realities, the elements of superiority to pull up the elements of inferiority from their conditions.

In response to IDRMs supporters, Lipton (1977) proposed the urban bias model [UBM] of economic development arguing that countries experience underdevelopment due to the premeditated discrimination between rural areas and urban centres. Usually, more developmental projects and investments are by design undertaken in urban centres contrary to rural areas. This gives urban residents the opportunity to be more organised and politically powerful than rural dwellers, thus prompting villagers to migrate to towns in search of better job opportunities, crowd out of the informal sector employment and contribute towards the increase of social vices in cities. To remedy this situation, Streeten (1979) suggested the basic needs approach [BNA] to economic development as a critique of the macro level of economic growth theories in addressing the problem of economic development. Consequently, BNA postulates that for a country to witness economic development, it must abate mass deprivation, give everybody the opportunity to live a decent life by accessing human vital needs: food, education, clothing, shelter, and medication; albeit the threshold for mass deprivation reduction is undefined.

2.3. Theories of Economic Development: 1980s-1990s

The market fundamentalism model or neoclassical counterrevolution [MFM] dominated the period 1980s-1990s. Lal (1985), Bauer (1984), Little (1982), Balassa (1982, 1971), Krueger (1978), Bhagwati (1978), and Johnson (1971) are prominent writers who have broadly debated the free market approach [FMA], public choice approach [PCA] or new political economy approach [NPEA], and market friendly approach [MFA] of MFM in their works. FMA challenges the model of public ownership, planning and control of economic activities by the state through erroneous pricing policies, misallocation of resources, corruption, and emphasises the important role of free markets, open economies and privatisation of inefficient public enterprises to stimulate growth and economic development in LICs.

Conversely, PCA or new political economy approach [NPEA] credits the government of doing nothing right and argues that the intervention of the government in the economy only leads to misallocation of resources and confiscation of private property, which in turn culminates in reduction in individual freedoms. PCA recommends minimal involvement of the government in economic activities of the economy as the best option that can facilitate economic development. Midway, MFA denounces the presence of markets imperfections in LICs, mainly in the areas of research and development, environmental outcomes, investment coordination, and

acknowledges the role the state could play in facilitating the operation of markets through market friendly interventions: creation of a suitable atmosphere for private enterprise and investment in social amenities (Roads, schools, health facilities...). Citing the success stories of countries like Singapore, Taiwan and South Korea as specimen, these theories argue that market fundamentalism is the key to economic development for LICs. The significance of these three missing components paved way to the development of the endogenous growth model [EGM] and the coordination failure model [CFM] of economic development.

2.4. Theories of Economic Development: 1990s-2015

The early years of 1990s to 2015 correspond to the period of contemporary models of economic development and underdevelopment [CFM, Big push model, O-Ring model, Hausmann-Rodrik-Velasco decision tree model]. These new theories draw on the arguments expressed by the classic theories of economic growth and economic development showing that development is possible but harder to achieve in LICs for today there are more obstacles than ever before on the path of economic development of LICs. The main argument of the new theories is that for a successful development to occur there must be an effective and efficient coordination or complementarities among the various stakeholders of the development process.

MDGs agenda stresses on eight universal values that affect humanity and threaten its existence due to the multiplier effects of the globalisation process of the world. Having perceived the dangers looming their economies in terms of unwanted migration, financial pressures on the state budget to cover social insurance benefits of migrants' children, unemployment grants to jobless people, and persistent needs for assistance in domestic affairs of LICs as a result of poor living conditions of people in these economies, MICs put in place MDGs agenda to reverse the trend of events; while giving the impression that they are concerned with the economic progress of the entire humanity on earth. The agenda proposes (i) to halve the rate of extreme poverty and hunger by providing full and productive employment and decent work for all, including women and young people between 1990 and 2015, (ii) to ensure that, by 2015, children everywhere, boys and girls alike, have completed at least a full course of primary education, (iii) to eliminate gender disparity in primary and secondary education by 2005 and in all levels of education by 2015, (iv) to reduce child mortality rate by 67% between 1990 and 2015. The other four remaining points of the agenda focus on (v) reducing the maternal mortality ratio by 75% between 1990 and 2015 and offering universal access to reproductive health by 2015, (vi) combating and reversing the incidence of HIV/AIDS, malaria and other major diseases by 2015, (vii) ensuring environmental sustainability through reduction of loss of environmental resources, biodiversity loss, and 50% reduction of the proportion of people without sustainable access to safe drinking water and basic sanitation by 2015, and (viii) developing a global partnership for development through predictable, nondiscriminatory trading and financial system with a commitment to good governance both nationally and internationally, holistic appreciation of debt problems to make debts of LICs bearable in the long term, provision of essential drugs at affordable rates to LICs, making available the benefits of information and communication technologies to LICs (United Nations Development Programme [UNDP], 2014). Successes have been recorded around the globe with respect to the goals of the agenda but in general the targets are far from being achieved for LICs, hence the passage as of 2016 to the 2030 agenda of sustainable development goals [SDGs].

2.5. Theories of Economic Development: 2016-2030

The passage from the 2015 MDGs to the 2030 SDGs is a testimony that the millennium development targets set for humanity against 2015 have not been achieved to expectations for MDGs achievements were unevenly distributed across the globe both thematically and regionally. Furthermore, it is observed that MDGs only applied to LICs, but the scope for SDGs is universal taking all United Nations [UN] member countries into account with a more detailed plan of action for the universe. The new posture with the 2030 agenda for SDGs is to draw a plan for collective prosperity in a sustainable ecosphere where mankind can live fruitful, exciting and pacific lives on earth (Woodbridge, 2015).

SDGs agenda is a universal 5Ps action plan focused on people, planet, prosperity, peace, and partnership, set to overcome human misery and generate prospects for all by the year 2030. The 17 SDGs can be grouped with

respect to each of the 5Ps of the action blueprint as follows. The goals for people's concerns are: goal 1 on ending all forms of poverty everywhere; goal 2 on ending hunger, attaining food security, improving nutrition and promoting sustainable agriculture; goal 3 on ensuring healthy lives and promoting wellbeing for all generations; goal 4 on guaranteeing inclusive and impartial quality education and encouraging lifetime learning prospects for all; and goal 5 on achieving gender equality and empowering all women and girls. Others goals in that series include: goal 6 on warranting the availability and sustainable management of water and sanitation for all; goal 7 on safeguarding the access to cheap, dependable, bearable and modern energy for all; and goal 8 on promoting sustained and inclusive economic growth, full and productive employment, and decent work for all (UN, *s.a*).

The goals addressing planet concerns range from goal 13 on taking urgent action to combat climate change and its impacts; goal 14 on protecting and sustainably using the oceans, seas and marine resources for sustainable development to goal 15 on guarding, restoring and encouraging sustainable use of terrestrial ecosystems, sustainably managing forests, fighting desertification, ending and reversing land degradation, and stopping biodiversity loss. The goals alluding to prosperity fears are accommodated in goal 9 on edifying resistant infrastructure, supporting inclusive and viable industrialisation and fostering innovation; goal 10 on narrowing inequality within and among countries; goal 11 on making cities and human settlements inclusive, safe, resilient and sustainable; and goal 12 on ensuring sustainable consumption and production patterns (UNDP, *s.a*). The goal referring to peace anxieties is goal 16 on promoting peaceful and inclusive societies for sustainable development, offering access to justice for all and fashioning effective, accountable and inclusive institutions at all levels; whilst goal 17 on reinforcing the means of implementation and renewing the global partnership for sustainable development captures the partnership torments of the agenda (UN, 2019).

In 2020, just four years away from 2016, considerable efforts have been observed in the implementation of SDGs. A wide array of actors including the scientific community, civil society, local authorities, international organisations, and businesses are committed to SDGs agenda in a *modus operandi* that breeds optimism in the scheme for the forthcoming 10 years. Still in line with this hope, at least 150 countries have developed national policies to address the challenges of rapid urbanisation. Besides this, the European Union [EU] and other 71 countries have put in place at least 300 policies and instruments in support of sustainable consumption and production. Furthermore, countries are making concrete arrangements to protect the planet as marine secured zones have doubled since 2010; working openly to dampen unlawful fishing. Also, 186 countries have endorsed the Paris Agreement on climate change, and almost all of them have disclosed their first national resolute donations for the pact. From the human perspective, the under-5 mortality rate dropped by 49% between 2000 and 2017, immunisations saved millions of lives, extreme poverty waned drastically, and majority of the people on earth now has access to electricity (Guterres, 2019 in UN, 2019: 2). Yet these efforts need to be collectively upheld in order to realise the 17 SDGs in totality.

2.6. Synthesis of Economic Development Theories

A perusal of the classic theories of economic growth and economic development reveals two opposite views of the state of underdevelopment in LICs. On one hand, the underdevelopment is perceived as an externally induced phenomenon owing to oppression of the international capitalist system and MICs. On the other hand, it is regarded as an internally induced episode mainly associated with poor policies and excessive government interventions of LICs. Also, given the pertinence of issues exposed by IDRM and MFMs, one can infer that these theories are very much aware of the ideological views, economic conditions, and problems of LICs contrarily to the posture presented by SCMs and LSMs of economic growth as regards LICs' realities. Yet no single model of economic development can be proclaimed as universal and suitable in all situations because every LIC has different realities in spite of their common characteristics. In the end, one can argue that the theories so far examined seem to be contradictory. All the theories reviewed are significant and provide in one way or the other insights for the understanding of the dynamic process of economic development for each possesses weaknesses and strengths.

In summary, IDRM's reject the claims of previous models of economic development so far studied to lay more emphasis on international power imbalances and the need for fundamental economic, political and institutional reforms at both the domestic and international levels. In extreme cases, these call for outright industrial nationalisation hoping that the public ownership and control of assets may be a more effective strategy for poverty eradication, creation of employment opportunities, income inequalities reduction and improvement of the standard of living of the masses. In spite of the steps taken in denouncing and apportioning blames to suspected causes of underdevelopment of LICs, these theories give no insight on how economic development can be initiated and sustained. Also, the application of the models in some LICs such as China and India did not yield the expected results of economic development until they renounced protectionism strategy and subscribed to market economy approach by reopening their frontiers to the rest of the world in 1978 and after 1990, respectively. Besides, the 2015 MDGs agenda did not yield the expected results by the target dates. Many people in LICs are still living with the problems of feeding, shelter, education, medication, accessing safe drinking water and sanitation services. In the same vein, the rates of poverty and unemployment are still high, whilst the income inequality gap between socioeconomic groups is widening daily. Finally, the 2030 SDGs agenda raises hope after highlighting significant progress achieved in some areas concerning the universal 5Ps action plan, especially in the area of access to electricity. However, isolated achievements are not sufficient to drive progress across all the 17 SDGs. Therefore, there is the need to lend a particular attention to the behaviour of stakeholders of SDGs programme over the remaining 10 years of the scheme until 2030 before taking a definite stand.

3. Methodology

Cameroon is situated in central Africa. The country is governed through 10 administrative regions: Adamaoua [AD], Centre [CE], East [ES], Far North [FN], Littoral [LT], North [NO], Northwest [NW], South [SU], Southwest [SW] and West [OU] (*Ministère de l'Administration Territoriale et de la Décentralisation* [MINATD], 2013). For this paper, the area of concern comprises NW, SW, and OU regions of the country. The study area lays between latitude 3° 80' and 8° North and between longitude 8° and 12° East of the globe [Figure 1]. It covers a total land mass of 56602 Km² (PopulationData.net, 2019) and is bordered on the North and the West by Federal Republic of Nigeria, on the South by LT Region, and on the East by AD and CE regions (Ministry of Economy, Planning and Regional Development [MINEPRD], 2012:13). The estimated population of the study area stood at 5443488 inhabitants (PopulationData.net, 2019).

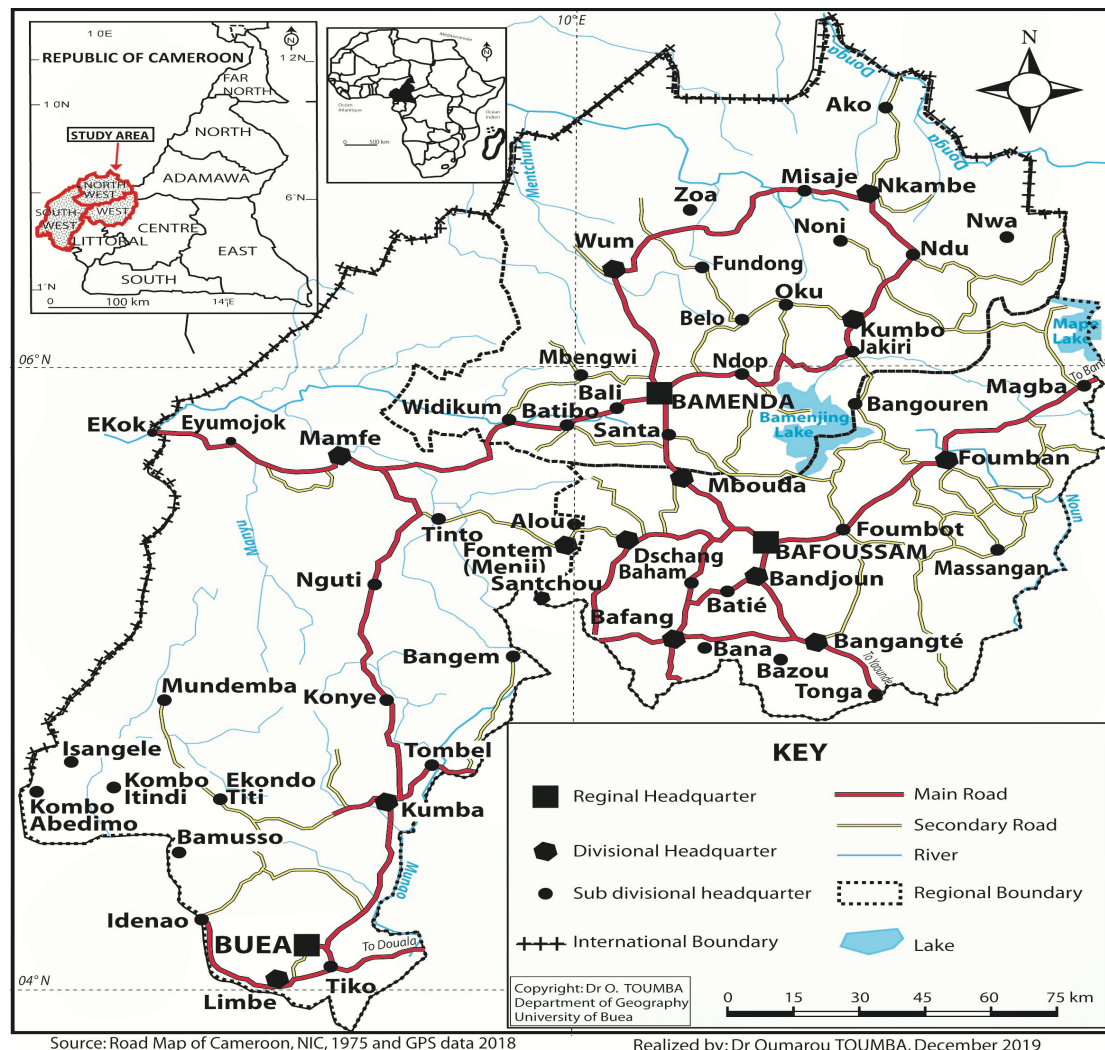

Figure 1: Geographical Map of Northwest, Southwest and West Regions of Cameroon

This study employs simple descriptive method of data analysis to attain the objectives of the inquiry. This involves the use of percentages, ratios, tables and diagrams in the interpretation of collected data. More so, the paper generates data with the help of personal observations and structured interviews beside 300 respondents from NW, SW, and OU regions of Cameroon among whom 270 (90%) are community members randomly selected and 30 (10%) are members of the Diaspora purposively chosen. NW, SW, and OU regions receive particular attention in this study due to the sociopolitical crisis shaking NW and SW regions since 21 November 2016 and the glaring spillover effects of this crisis on OU Region owing to its proximity to these two regions. Data related to community infrastructures development and social crisis have also been derived from secondary sources.

4. Data Analysis and Discussion of Results

This section offers a review of the processes of social infrastructures provision and distribution in Cameroon across time. Social infrastructures such as hospitals, schools, roads, houses, electricity and drinking water are the major ones retaining the attention in this study. Also, it captures the extent of the Diaspora involvement in the economic development process of communities in Cameroon, and examines the problems of the Diaspora in the economic development process in Cameroon.

Before addressing its specific objectives, the study presents the sample population that helped in assessing the phenomenon under investigation in Table 1. The elements of the sample are discussed accordingly in the following lines. Out of the 270 members drawn from the selected communities, 78 (28.88%) are from OU

Region, 94 (34.81%) come from SW Region, and 98 (36.29%) originate from NW Region. A proportion of 192 (71.11%) of the community members comes from NW and SW regions because these two regions are the playground of the 21 November 2016 sociopolitical crisis that heavily affected the progress of local communities in Cameroon.

Table 1: Distribution of Sample Elements from the Selected Communities

Community	Frequency	Percentage [%]
Northwest	98	36.29
Southwest	94	34.81
West	78	28.88
Total	270	100

Source: Authors (2019).

4.1. Process of Social Infrastructures Provision and Distribution

The provision of hospitals, schools, roads, and electricity at affordable rates in Cameroon for the population is the sole prerogative of the State. However, drinking water provision and distribution receives a specific treatment due to two fundamental reasons. One, drinking water is a prerequisite of life for all living things. Two, the creation of drinking water does not require colossal financial investments compared to provision of the other social amenities mentioned earlier on. Furthermore, drinking water can be provided either by individuals or communities as well as the State does.

The anxiety for better access to potable drinking water in Cameroon has a relatively long history of existence. Before privatisation in 1900, the customary laws described the manners in which water is to be provided to the community. The village head mandates the delegate for social and economic matters to realise the creation of wells and layout of springs for the village. When the need for such a venture arises; members of the community deploy physical, material or financial efforts to create the communal water supply project. Once the drinking water is produced, accessing it becomes a right to the general public in the village. Nevertheless, the traditional authority restricts the use of water from public wells for farming activities. In 1900, the colonial administration arrived in Cameroon, seized the control of all natural resources and subsequently started putting in place a network for water resources development and management in the country. Water supply points were created across the country on formal request from the community to the colonial administrator – the Resident. Upon the Resident's approval of the water project, the Public Works Department [PWD] engineer of the colonial administration and the community join hands to create the water supply point.

Following Cameroon's independence in 1960, the new administration leaned on the colonial water management policy but introduced gradual changes that reflect its image of the country. The authority charged with the responsibility to handle natural resources in general and water in particular changes from one institution to another. The Rural Development Secretariat [RDS] that dealt with forest, agriculture and water resources was transformed into three different ministries via the Ministry of Water and Forestry [MoWF], Ministry of Agriculture [MoA] and Ministry of Water, Mines and Energy [MoWME]; respectively. However, in the process of water management policy, the government continued to design the water sector policy of the country and involved three key ministries in the policy enforcement. The Ministry of Energy and Water Resources [MoEWR] took care of drinking water supply and sanitation matters by entrusting the then Cameroon National Water Corporation [CNWC] the task of exploitation, treatment, distribution and sale of potable water to urban centres. On the other hand, the Ministry of Health [MoH] intervened to guarantee sanitation services where and when necessary, while the then ministry of agriculture enforced government agricultural hydraulics policy to provide drinking water to rural areas. Besides these three ministries, nongovernmental organisations and religious bodies constructed boreholes and wells to serve the urban and rural population's needs in drinking water. But in extreme cases of drinking water needs, village associations gather resources to create water supply for the community.

The 1980s economic downturn effects became manifest in Cameroon in 1990s and this handicapped CNWC's ability to meet anticipated results in the distribution of potable water to users in the country. For customers failed to pay their water bills regularly, the corporation finds it extremely difficult to cover its full cost of operation. The persistence of this state of affairs paved the way to the privatisation of CNWC in 2006. Despite the transfer of responsibility in drinking water provision from state owned to private managed company, the government retained the monopoly of defining the global water policy of the country. With the privatisation of CNWC, the water company splits into Cameroon Water Utilities Corporation [CAMWATER] and *La Camerounaise des Eaux* [CDE]. In this new dispensation, CAMWATER handles the management, maintenance and networking aspects of the corporation's infrastructures; while CDE takes on the exploitation, treatment, distribution, and commercialisation of water to users in urban and peri urban centres across the country. Water dealers also play a role in the supply of water in the country. Such dealers are in two categories – namely water traders who retail water at 25 FCFA to 50 FCFA a jerry can of 20 litres, and vendors who collect water from companies' water supply points or buy it from water traders to resell at 100 FCFA to 500 FCFA per jerry can of 20 litres depending on where water is acquired and where it is to be supplied. Figure 2 illustrates the process of drinking water creation for the satisfaction of users' demand for the resource in Cameroon across time.

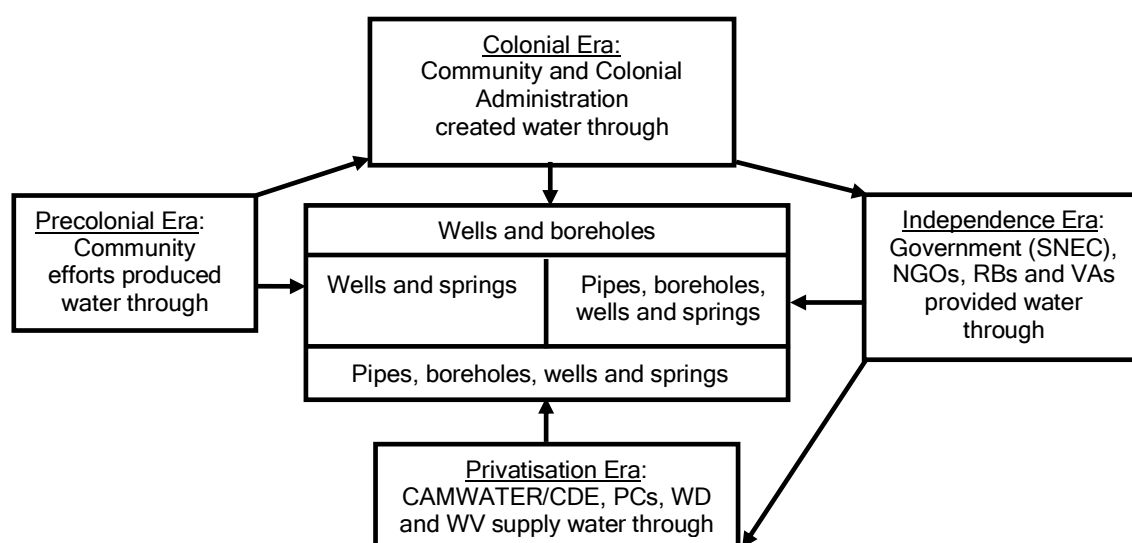

CNWC: Cameroon National Water Corporation
 CAMWATER: Cameroon Water Utilities Corporation
 CDE : *Camerounaise des Eaux*
 NGOs: Nongovernmental Organisations

VA: Village Associations
 WD: Water Dealers
 RBs : Religious Bodies
 PCs: Private Companies

Source: Authors (2019).

Figure 2: Process of Drinking Water Creation across Time in Cameroon

4.2. Inventory of Diaspora Developmental Projects

The participation of CD in the nation building process can be measured from various angles. Some of these perspectives include the provision of financial support to family members to run business, sponsor of family members' education, construction of family residence, renovation of schools and hospitals in the community, renovation and creation of community water supply points. A summary of CD developmental ventures realised in selected communities in the country, based on the views of the 270 (90%) community members, is presented in Table 2. In Table 2, it is observed that the participation of CD in the nation building process is more focused on solving individual than communal problems. About 85% of CD investments across NW, SW and OU regions of Cameroon are tailored towards family projects such as the construction of family residences (40.59%), sponsor of family members' education (34%), and provision of financial support to family members to run business (10.31%). The remaining 15% of CD investments in the study area cover community projects such as the equipment of schools (4.76%), renovation of schools (2.62%), equipment of hospitals (2.50%), renovation of

hospitals (2.19%), renovation of water supply points (1.77%), and creation of community water supply points (1.22%). Yet in a total of 1638 projects realised by CD in the study area, NW accounted for 48.11%, against 28.26% for SW, and 23.62% for OU. These statistics reveal that members of CD from NW Region are more projects-driven than their NW and OU counterparts, perhaps due to the high level of survival competition among NW Region populations and communities.

Table 2: Projects Realisation of CD to Beneficiaries in Selected Communities

Project	Community	North west	Percentage [%]	South west	Percentage [%]	West	Percentage [%]	Grand Total	Percentage [%]	Rank
Financial Support for Business		64	8.12	20	4.31	85	21.96	169	10.31	3
Sponsor for Education		223	28.29	113	24.40	221	57.10	557	34.00	2
Construction of Family Residence		348	44.16	281	60.69	36	9.30	665	40.59	1
Hospital Renovation		21	2.66	6	1.29	9	2.32	36	2.19	7
School Renovation		27	3.42	4	0.86	12	3.10	43	2.62	5
Creation of Water Supply Points		14	1.77	2	0.43	4	1.03	20	1.22	9
Renovation of Water Supply Points		21	2.66	3	0.64	5	1.29	29	1.77	8
School Equipment		44	5.58	26	5.61	8	2.06	78	4.76	4
Hospital Equipment		26	3.29	8	1.72	7	1.80	41	2.50	6
Total of Realised Projects		788	100	463	100	387	100	1638	100	-
Projects Percentage [%] of Community in Projects Grand Total		48.11	-	28.26	-	23.62	-	100	-	-
		C2	C3	C4	C5	C6	C7	C8	C9	C10

Source: Authors (2019).

Note: Relative values in column **C3** are percentages associated with each project in NW. Relative values in column **C5** are percentages associated with each project in SW. Relative values in column **C7** are percentages associated with each project in OU. Relative values in column **C9** are percentages associated with each project Grand Total for NW, SW, and OU regions. Relative values in last row represent percentages associated with the share of each region total of realised projects in the Grand Total for the three regions. Values in column **C10** indicate the ranking of the projects realised by CD in NW, SW, and OU regions of Cameroon.

4.3. Problems and Concerns of the Diaspora

In spite of the role the Diaspora plays in stimulating economic development of communities and the country at large, there are instances in which it has caused untold havocs. In one way or the other, the Diaspora has sponsored refractory behaviours aimed at destabilising countries. In the same vein, it has succeeded in establishing international drug trafficking networks, and international violence networks that are threatening peace and security in the whole world today. The problems of CD are summarised in Table 3, while the concerns of CD are presented in Table 4. A perusal of Table 3 reveals several undesirable effects of CD actions on NW, SW, and OU regions of Cameroon, ranging from spread of fake news, attack of state symbols, closure of businesses, civil disobedience to conduct of illegal meetings, education deprivation of children, threat of people's peace and extortion of monies from the population.

Table 3: The Undesirable Effects of CD Activities

Repercussion on Activity	Northwest and Southwest	West
Spread of Fake News	Creation of Ambazonia State from abroad (Mbodiam, 2019a:8), entertainment of fear in the society (International Crisis Group [ICG], 2017)	Fear of debating success or failure of creation of Ambazonia State due to repression
Attack of State Symbols	Burning of hospitals and schools (Mbodiam 2019a:8), At least 235 military and police officers killed (ICG, 2019:13), humiliation of	Sense of humiliation for government supporters and state of pleasure for government detractors

	Head of State on official visits by Cameroonians abroad, ransacking of Cameroon diplomatic representation abroad by CD	
Conduct of Illegal Gatherings	Clandestine power defying republican order and creation of State dualism, loss of State trust and control in rural areas (ICG, 2017)	Propagation of hatred message in villages and cities
Civil Disobedience	Instauration of ghost town operations every Monday (Mbodiam, 2019a:8) and any State commemoration day (ICG, 2017:13)	Distortion of plans due to uncertainty
Closure of Businesses	Average of 70% of agribusinesses inaccessible, loss of 40 million FCFA turnover to beverage industry, material loss of 500 million FCFA to vandalism and theft, shortfall of 4.9 billion FCFA to beverage sector, burning of delivery trucks with an average of 22.5% delivery decline to customers, total job cuts of 15% in the sector (Andzongo, 2019b:12), 16 employees of Cameroon Development Corporation [CDC] killed and at least 98 seriously wounded (Mbodiam, 2019c:10), ransacking of 206 Mobile Telephone Network [MTN] sites since April 2018 (Bongang, 2018 in Mbodiam, 2019b:9), cut of internet access for 92 days costing 2 billion FCFA loss to commercial and industrial sectors (ICG, 2017: 13, 22)	Fall in business turnovers of businessmen as a result of closure and decimation of business outlets caused by recurrent ghost towns and shutdowns
Shutdown of Schools	At least 4400 schools closed (Andzongo, 2019a:11), attack of students by separatists, abduction of 19 teachers and 58 students at universities of Bamenda and Buea between January 2019 and August 27, 2019 (Sadi, 2019 in Business in Cameroon [BC], 2019: 20), extra childcare demands to women, rise in juvenile delinquency, teenage pregnancies and school dropout (ICG, 2017:23), loss of years of schooling by children of poor people who cannot relocate their siblings to places where school activities run hitch free	Overcrowding of schools by children of internally displaced people running away from atrocities caused by secessionists in NW and SW regions,
Call for Secession	At least 1000 suspected secessionists killed (ICG, 2019:13)	Temptation for independence tendencies by misled individuals
Violence for Money	Ransom paid by workers to escape robberies and killing (Andzongo, 2019b:12)	Fear and suspicion of people who fled from NW and SW regions
Attack on Population	Flee of 21291 people to Nigeria (Andzongo, 2019a:11), brutalisation of students going to school, threat and assault of people ignoring secessionists boycott order (Mbodiam, 2019a:8), killing of 1850 people and internal displacement of 530000 persons with 35000 others fled to Nigeria (ICG, 2019:13), strike notices and threats against residents (Sadi, 2019 in BC, 2019:20).	Fear of travelling to NW and SW regions in spite of the proximity, relocation of many people from OU Region back home or to other horizons
Settlement of Scores	Hunting of Professor T Alexis, murder of Professor MK Paul, kidnapping of Dr. VW Andrew, abduction of Professor Catherine LF	Relocation of some lecturers to Mbouda, Bafoussam, Dschang

and Dr. S Martin, attack of Drs. MT Samuel and DF Cletus, threat of Dr. JU Eléazar, attack of Professors ML Cornelius and NF Godfrey residences in Bamenda and Buea leading to declaration of strike from 4 to 5 December 2019 by Lecturers of The University of Bamenda as protest against the kidnaping of colleagues on their way to or return from work place

Source: Authors (2019).

The concerns raised by the 30 (10%) members of CD interviewed are presented in Table 4 and discussed accordingly thereafter. The complaints of CD members span the feeling of neglect and non recognition of CD by the Government of Cameroon, lack of economic security and freedom that could encourage local and self development initiatives of intellectuals, poor investment network, hostile business environment, excessive government political influence in economic activities, bureaucratic bottlenecks to Government pride among others. A reversal of these impediments stands as the appropriate path to the economic development journey of the country, according to the members of CD.

Table 4: Obstacles to the Participation of CD in Economic Development Process

Concern	Expectation
Neglect and Lack of Recognition	Recognition and integration of Diaspora potentials into the country's development strategies
High Government Taxes	Reduction of government taxes
Lack of Economic Security and Freedom	More economic security and freedom in the country
Poor Business Environment	Considerable improvement of the business environment
Poor Investment Network	Improvement of the investment network
Inadequate Tax Policies	Implementation of adequate tax policies
Misinformation	Fight against misinformation
Subjugation to Customs and Beliefs	Adaption and implementation of a compulsory school law for every child up to the class where philosophy is taught
Excessive Government Influence	Curtail of government influence
Disconnection with Local Realities	Frequent seminars on local realities to Diaspora audience
Mystical Attack Owing to Jealousy	Fight against witchcraft and devilish behaviours through adoption and execution of anti progress laws
Selfishness	Introduction and teaching of religious studies, moral and ethics courses from primary school to the university
Administrative and Bureaucratic Bottlenecks	Fight against corruption through computerisation and digitalisation of the whole administrative system
Government Pride	Seminars on humility for all civil servants and members of the government

Source: Authors (2019).

5. Conclusion, Recommendations and Shortcomings of the Paper

In the precolonial epoch everybody in the community participates in the creation of the communal water supply point. In the colonial era, a whole network for water resources development and management involving indigenous people is put in place to satisfy the water needs of the community. During independence time, the government takes up the responsibility of designing the water sector policy of the country and uses three key ministries for its implementation. Drinking water supply and sanitation is handled by MoEWR who entrusts CNWC the task of exploitation, treatment, distribution and sale of potable water to private households and councils in cities. MoH intervenes within the framework of government policy to guarantee sanitation services where and when necessary, while MoA provides drinking water to rural areas. Furthermore, CNWC and village

associations regulate users' misconduct in water use through payment of fines and in extreme cases supply cuts. After the takeover of water supply by the private sector, the water company breaks into CAMWATER and CDE, where the former handles the management, maintenance and networking system of infrastructures of the corporation and the later undertakes the exploitation, treatment, distribution and commercialisation of water to private households and few public taps to councils in favour of the general public in urban centres. Besides, households with limited access to private supply and public taps purchase drinking water from dealers at 25 FCFA to 50 FCFA a jerry cane of 20 litres or 100 FCFA to 500 FCFA per jerry cane of 20 litres depending on the distance where water is acquired and to be delivered. In cases of nonpayment of water bills, the private water corporation disconnects users from the water supply network and fines them accordingly.

For effective support and efficient participation to the economic development process of Cameroon, the following recommendations need to be taken into consideration. On one hand, the Government of Cameroon should (a) admit and integrate the potentials of CD into the country's development strategies, (b) reduce government taxes and government influence as well as adopt and implement adequate tax policies, (c) improve business environment and business network, (d) computerise and digitalise the whole administrative system, and (e) lay more emphasis on SDGs theory of development to solve the problems of people misery in the country. Conversely, CD should (i) increase the budget allocated to the creation and renovation of water supply points, (ii) adopt a more community driven economic contribution than a family oriented economic support, and (iii) learn to portray a good image of their country wherever they find themselves.

Despite the merits of the enquiry, some of its shortcomings can be outlined as follows. This study highlights the positive and negative contributions of CD to the process of economic development of Cameroon in only three regions of the country. The investigation is mute on AD, ES, FN, and LT regions of the country that are also witnessing sociopolitical turmoil and socioeconomic disorders. Besides, the paper pays little attention to inferential tools of data analysis that can enable forecasts of the consequences of the phenomenon under study into the future of Cameroon with high predictive power. Furthermore, the influence of international diplomacy in the sociopolitical commotion rocking the country has not been underscored in the study. Finally, statistics provided in this study are mere assessments of the quantitative aspects of the inquiry. As a result, they are to be treated with great caution.

References

- AllAfrica (2019). Africa: Remittances to Africa overtakes foreign direct investment. Retrieved December 08, 2019 from <https://allafrica.com/stories/200512080558.html>
- Amin, S. (1974). *Accumulation on a world scale*. New York: Monthly Review Press.
- Amin, S. (1976). *Unequal development: An essay on the social formations of peripheral capitalism*. New York: Monthly Review Press.
- Andzongo, S. (2019a). "4400 schools closed in Cameroon's Anglophone regions amid secessionist crisis", Focus. In *Business in Cameroon*, No. 79:11. Retrieved October 07, 2019 from <https://www.businessincameroon.com/pdf/BC79.pdf>
- Andzongo, S. (2019b). "60-80% of agribusinesses are out of access in Northwest and Southwest Cameroon due to unrest", Focus. In *Business in Cameroon*, No. 79:12. Retrieved October 07, 2019 from <https://www.businessincameroon.com/pdf/BC79.pdf>
- Balassa, B. (1971). *The structure of protection in developing countries*. Baltimore, USA: Johns Hopkins Press.
- Balassa, B. (1982). *Development strategies in semi-industrial economies*. Baltimore, USA: Johns Hopkins Press.
- Baran, P. A. (1957). *The political economy of growth*. New York: Monthly Review Press.
- Bauer, P. T. (1984). *Reality and rhetoric: Studies in the economics of development*. London: Weidenfield & Nicolson.
- Bhagwati, J. N. (1978). *Anatomy and consequences of exchange control regimes*. Cambridge: Ballinger Publishing Company.
- Boeke, J. H. (1953). *Economics and economic policy of dual societies*. New York: International Secretariat, Institute of Pacific Relations.
- Bongang, M. N. (2019). Statement from MTN corporate communications Manager.
- Bornman J. (2018). Rwanda "follows its opposition and kills them", *New Frame*, 13 November 2018. Retrieved November 27, 2019 from <https://www.newframe.com/rwanda-follows-its-opposition-and-kills-them/>

- Business in Cameroon (2019). The outstanding cost of the Anglophone crisis, No. 79, September. Retrieved October 07, 2019 from <https://www.businessincameroon.com/pdf/BC79.pdf>
- Cardoso, F. H. (1977). The consumption of dependency theory in the United States. *Latin American Research Review*, 12(3), 19-20.
- Chenery, H. B. (1960). Patterns of industrial growth. *American Economic Review*, 50(3), 624-654.
- Chenery, H. B., & Syrquin, M. (1975). *Patterns of development: 1950-1970*. New York: Oxford University Press.
- Chenery, H. B., & Taylor, L. J. (1968). Development patterns among countries and over time. *Review of Economics and Statistics*, 50(4), 391-416. <http://dx.doi.org/10.2307/1926806>
- Commission for Africa [CA] (2005). *Our common interest*. Report of the Commission for Africa. Retrieved December 09, 2019 from http://web.worldbank.org/archive/website01021/WEB/IMAGES/11_03_05.PDF
- De Monchrétien, A. (1891). *Les tragedies de Monchrétien*. Paris: Nourritet Cie.
- De Montclos, M. P. (2003). *Les diasporas africaines et leur pays d'origine*, *Esprit*, 27 (300), 114– 124.
- De Montclos, M. P. (2005). *Diasporas, remittances and Africa South of the Sahara: A strategic assessment*, Pretoria: Institute for Security Studies [ISS] Monograph Series No. 112. Retrieved December 05, 2019 from <https://www.files.ethz.ch/isn/118310/112FULL.pdf>
- Domar, E. D. (1947). Expansion and employment. *American Economic Review*, 37(1), 34-45.
- Dos Santos, T. (1969). The crisis of development theory and the problem of dependence in Latin America. *Siglo*, 21, 36-54.
- Dos Santos, T. (1973). The crisis of development theory and the problem of dependence in Latin America. In H. Bernstein (ed.). *Underdevelopment and development: The third world today*, 57-79. New York: Penguin Books.
- Easterly, W. R. (2001). *The elusive quest for growth: Economists' adventures and misadventures in the tropics*. Cambridge: Massachusetts Institute of Technology Press.
- Egbe, C., & Ndubisi, C. (1998). Institutional factors and immigrant investment in homeland: Nigerians in the USA. In A. Nwaneri (ed). *Nigeria: Visions for the future*, Ibadan: Macmillan.
- European Investment Bank [EIB] (2006). *Study on improving the efficiency of workers' remittances in Mediterranean countries*. FTF/REG/01/2005 Final Report, Rotterdam: EIB. Retrieved December 08, 2019 from https://www.eib.org/.../femip_workers_remittances_en.pdf
- Fei, J. C. H., & Ranis, G. (1964). *Development of the labour surplus economy: Theory and policy*. Homewood, ILL: Richard Irwin.
- Franck, A. G. (1967). *Capitalism and underdevelopment in Latin America*. New York: Monthly Review Press.
- Galeano, E. (1973). *Open veins of Latin America*. New York: Monthly Review Press.
- Geographical Planet Survey [GPS] data 2018
- Ghosh, B. (2006). *Migrants' remittances and development: Myths, rhetoric and realities*, Genrva, Switzerland: IOM and Den Haag, The Netherlands: The Hague Process on Refugees and Migration [THPRM]. Retrieved December 08, 2019 from https://publications.iom.int/system/files/pdf/migrants_remittances.pdf
- Guebourg, J. (1995). *Migrants et clandestins de la Grande Comore, Cahiers d'Outre-Mer*, 48 (191), 295–318.
- Guterres, A. (2019). Forward. In UN (2019). *The sustainable development goals report 2019*, New York: UN. Retrieved December 30, 2019 from <https://unstats.un.org/sdgs/report/2019/The-Sustainable-Development-Goals-Report-2019.pdf>
- Harrod, R. F. (1939). An essay in dynamic theory. *The Economic Journal*, 49(193), 14-33. <http://dx.doi.org/10.2307/2225181>
- Higgins, B. (1956). *The dualistic theory of underdeveloped areas: Economic development and cultural change*. Chicago: The University of Chicago Press.
- International Crisis Group [ICG] (2017). *Cameroon's Anglophone crisis at the crossroads*, Africa Report No. 250. Brussels, Belgium: ICG. Retrieved October 07, 2019 from https://d2071andvip0wj.cloudfront.net/.....anglophone-crisis-at-the-crossroads_0.pdf
- International Crisis Group (2019). "International Crisis Group says 20 months' riots in Anglophone regions killed 1850". In B. R. Mbodiam (2019). Interview. In *Business in Cameroon*, No. 79, 13. Retrieved October 07, 2019 from <https://www.businessincameroon.com/pdf/BC79.pdf>
- Jevons, W. S. (1871). *The theory of political economy*. London: Macmillan.
- Johnson, H. (1971). A word to the third world: A western economist's frank advice. *Encounter*, 37, 3-10.
- Jorgenson, D. W. (1961). Development of a dual economy. *Economic Journal*, 61, 309-334. <http://dx.doi.org/10.2307/2228770>
- Keynes, J. M. (1936). *The general theory of employment, interest, and money*. Cambridge: Cambridge University Press.
- Koser, K. (2002). *Une Diaspora divisée? Transferts et transformations au sein de la Diaspora Erythréenne, Politique africaine*, 85,64–74.

- Krueger, A. O. (1978). *Foreign trade attempts and economic development: Liberalization attempts and consequences*. Cambridge: Ballinger Publishing Company.
- Lal, D. (1985). *The poverty of 'development economics*. Cambridge: Harvard University Press.
- Lewis, W. A. (1954). Economic development with unlimited supplies of labour. *The Manchester School*, 22(2), 139-191. <http://dx.doi.org/10.1111/j.1467-9957.1954.tb00021.x>
- Lipton, M. (1977). *Why poor people stay poor: Urban bias in world development*. London: Temple Smith Press.
- Little, I. (1982). *Economic development: Theories, policies, and international relations*. New York: Basic Books.
- Malthus, R. T. (1798). *An essay on the principle of population*. London: Macmillan.
- Marshall, A. (1890). *Principles of economic: An introductory volume*. Canada, Rod Hay's Archive for the History of Economic Thought of MacMaster University. Retrieved February 11, 2015 from <https://www.marxists.org/reference/subject/economics/marshall/>
- Mbodiam, B.R. (2019a). "Socio-economic impacts of the Anglophone crisis in Cameroon". Focus. In *Business in Cameroon*, No.79, 8. Retrieved October 07, 2019 from <https://www.businessincameroon.com/pdf/BC79.pdf>
- Mbodiam, B.R. (2019b). "MTN Cameroon's 60% market share in the Anglophone region affected by ongoing crisis". Focus. In *Business in Cameroon*, No. 79, 9. Retrieved October 07, 2019 from <https://www.businessincameroon.com/pdf/BC79.pdf>
- Mbodiam, B.R. (2019c). "CDC expected to partially resume activities in Q3, 2019, after a violence-induced XAF32 bln loss in 2018". Focus. In *Business in Cameroon*, No. 79, 10. Retrieved October 07, 2019 from <https://www.businessincameroon.com/pdf/BC79.pdf>
- Menger, C. (1976). *Principles of economics*. Auburn, Alabama, USA: Ludwig von Mises Institute. Retrieved March 13, 2015 from http://mises.org/sites/default/files/Principles%20of%20Economics_5.pdf
- Ministère de l'Administration Territoriale et de la Décentralisation [MINATD] (2013). *Annuaire statistique du MINATD: Le MINATD en chiffres*, Edition 2013, Yaoundé: MINATD. Retrieved September 09, 2019 from https://www.osidimbea.cm.....annuaire_statistique_minatd_...
- Ministry of Economy, Planning and Regional Development [MINEPRD] (2012). *Buea communal development plan (CDP)*. Yaoundé: MINEPRD. Retrieved September 09, 2019 from <https://www.osidimbea.cm.....download.....CDP+Buea>
- Mohapatra, S., & Ratha, D. (s.a). Migrant remittances in Africa: An overview, Chap 1, 1-68. Retrieved December 08, 2019 from <http://siteresources.worldbank.org/...../476882-1157133580628/RemittanceMarketsInAfricaOverview.pdf>
- Mun, T. (1621). *A discourse of trade from England unto East Indies*. London: Nicholas Okes for John Pyper.
- Mun, T. (1664). *England's treasure by forraign trade or the balance of our foreign trade is the rule of our treasures*. London: Printed by J. G. for Thomas Clark.
- National Institute of Cartography [NIC] (1975). Road map of Cameroon
- Nations Unies [NU] (2018). *Le développement économique en Afrique : les migrations au service de la transformation structurelle, Rapport 2018*, New York, Genève : NU
- Pieterse, J. N. (2010). *Development theory: Deconstructions/reconstructions*. London: Sage Publications. <http://dx.doi.org/10.4135/9781446279083>
- PopulationData.net (2019). Cameroun. Retrieved December 09, 2019 from <https://www.populationdata.net/pays/cameroun/>
- Radio France Internationale [RFI] (2019). *Rwanda: polémique après les propos de Kagame sur l'assassinat d'un opposant, RFI Afrique*, 14 March 2019. Retrieved November 27, 2019 <http://www.rfi.fr/...20190314-rwanda-polemique-kagame-assassinat-opposant-sendashonga>
- Ranis, G., & Fei, J. C. H. (1961). A theory of economic development. *American Economic Review*, LI (3), 533-565.
- Ratha D., & Mohapatra, S. (2007). Increasing the macroeconomic impact of remittances on development. Retrieved December 06, 2019 from http://www.dilipratha.com/index_files/G8Berlin.pdf
- Ratha D., Mohapatra, S., Özden, C., Plaza, S., Shaw, W., & Shimeles, A. (2011). *Leveraging migration for Africa: Remittances, skills, and investments*, Washington DC, USA: Development Prospects Group, WB. Retrieved December 08, 2019 from <https://siteresources.worldbank.org/...../Resources/4768821157133580628/.....Book.pdf>
- Ricardo, D. (1817). *On the principles of political economy and taxation*. London: John Murray.
- Rodney, W. A. (1972). *How Europe underdeveloped Africa*. London: Bogle L'Ouverture.
- Rodrik, D. (2008). The real exchange rate and economic growth. *Brookings Papers on Economic Activity*, 2, 365-412. Retrieved March 13, 2015 from http://www.brookings.edu/~media/projects/bpea/fall-2008/2008b_bpea_rodrik.pdf

- Rolley S (2019). *Rwanda: Paul Kagame met en garde, l'opposition s'inquiète, RFI Afrique*, 15 Novembre 2019. Retrieved November 27, 2019 from <http://www.rfi.fr/.../20191115-rwanda-inquietudes-detracteurs-paul-kagame-menaces>
- Rostow, W. W. (1960). *The stages of economic growth: A non-communist manifesto*. Cambridge: Cambridge University Press.
- Sadi, R. E. (2019). "Government has taken measures to ensure a secure and successful school year in the Anglophone regions, Minister Sadi informs". Public management. In *Business in Cameroon*, No. 79, 20. Retrieved October 07, 2019 from <https://www.businessincameroon.com/pdf/BC79.pdf>
- Sembajwe, I. (1993). Effects of emigration to South Africa on Lesotho's demography and economy. In M. Touré & T. O. Fadayomi (eds). *Migrations et urbanisation au sud du Sahara*, Paris: Karthala.
- Smith, A. (1776). *An inquiry into the nature and causes of the wealth of nations*. Reprinted in 1976, United Kingdom: Clarendon Press. <http://dx.doi.org/10.1093/oseo/instance.00043218>
- Solow, R. M. (1956). A contribution to the theory of economic growth. *The Quarterly Journal of Economics*, 70(1), 56-94. <http://dx.doi.org/10.2307/1884513>
- Steuart, J. (1767). *Inquiry into the principles of political economy*. Canada: Rod Hay's Archive for the History of Economic Thought of MacMaster University. Retrieved February 11, 2015 from <https://www.marxists.org/reference/subject/economics/steuart/index.htm>
- Stiglitz, J. E. (2002). *Globalization and its discontents*. New York: W.W. Norton & Company.
- Streeten, P. P. (1979). A basic-needs approach to economic development. In K. P. Jameson, & C. K. Wilber (eds.). *Directions in economic development*, Paris: University of Notre Dame Press.
- Sunkel, O. (1966). The structural background of development problems in Latin America. *Deutschland: Weltwirtschaftliches Archiv*, 97(1), 22.
- Toumba, O. (2019). Sketch of geographical map of Northwest, Southwest and West regions of Cameroon. Drawn in December 2019
- United Nations [UN] (s.a). Transforming our world: The 2030 agenda for sustainable development, A/RES/70/1. Retrieved December 30, 2019 from <https://sustainabledevelopment.un.org/content/documents/21252030%20Agenda%20for%20Sustainable%20Development%20web.pdf>
- UN (2005). United Nations Office of the Special Adviser on Africa, Press Release. New York: UN.
- UN (2019). *The sustainable development goals report 2019*, New York: UN. Retrieved December 30, 2019 from <https://unstats.un.org/sdgs/report/2019/The-Sustainable-Development-Goals-Report-2019.pdf>
- United Nations Department of Economic and Social Affairs [UNDESA] (2017). *International migration stock: 2017 revision*. New York: UN. Retrieved December 29, 2019 from <http://www.un.org/en/.../desa/.../data/.....17.shtml>
- UNDP (s.a). Sustainable development goals. Retrieved December 30, 2019 from https://www.undp.org/content/dam/undp/library/corporate/brochure/SDGs_Booklet_Web_En.pdf
- United Nations Development Programme [UNDP]. (2014). *The millennium development goals: Eight goals for 2015*. New York: UNDP. Retrieved April 09, 2015 from <http://www.undp.org/mdg/>
- Wallerstein, I. M. (1980). *The modern world-system II: Mercantilism and the consolidation of the European world economy*. New York: Academic Press.
- Walras, L. (1899). *Elements of pure economics or the theory of social wealth*. Homewood, ILL: Richard Irwin.
- Weiss, T. L. (1998). *Migrants nigériens, la diaspora dans le Sud-Ouest du Cameroun*, Paris: L'Harmattan.
- Woodbridge, M. (2015). From MDGs to SDGs: What are the sustainable development goals? ICLEI BRIEFING SHEET-Urban Issues, No. 01. Retrieved December 30, 2019 from <https://www.localizingthesdgs.org/library/251/From-MDGs-to-SDGs-What-are-the-Sustainable-Development-Goals.pdf>
- World Bank [WB] (2003). *Somalia: Socio economic survey 2002*, Report No. 1, Somalia Watching Brief 2003, Nairobi, Kenya: WB. Retrieved December 08, 2019 from <http://siteresources.worldbank.org/.../Resources/Socio2prelims.pdf>
- WB (2006). *Global economic prospects: Economic implications of remittances and migration*. Washington DC, USA: WB. Retrieved December 08, 2019 from <http://pubdocs.worldbank.org/en/346121443469727614/Global-Economic-Prospects-2006-Economic-implications-of-remittances-and-migration.pdf>
- WB (2011). Migration and remittances factbook 2011. Washington DC, USA: WB.



Tax Incentives and Investment Growth: The Nigerian Perspective

Chukwuma C. Ugwu¹, Iyana E. Okwa², Ernest E. Inyang³

^{1,2,3} Department of Accounting, Faculty of Humanities, Management and Social Sciences, Federal University Wukari, Nigeria

Correspondence: Chukwuma C. Ugwu. Email: ucollins98@yahoo.com

Abstract

Tax Incentives and Investment Growth: the Nigeria perspective is aimed at determining the effect of tax incentives represented by corporate income tax rate and investment allowance on investment growth in Nigeria from 1985-2018. The study adopted Ex Post Facto Research Design and time-series data was used. Relevant secondary data for this study were collected from the Central Bank of Nigeria (CBN) Statistical Bulletin, the National Bureau of Statistics (NBS) and the Federal Inland Revenue Service (FIRS). The study employed ordinary least square estimation and used regression analysis to test the relationship between Tax Incentives and investment growth in Nigeria. The study shows that tax incentive policy is positively and significantly related to gross fixed capital formation. The findings showed that tax incentives have positive impact on gross fixed capital formation. The findings showed that there is a degree of relationship between corporate income tax and gross fixed capital formation; and that there is degree of co-variability between investment allowance and gross fixed capital formation in Nigeria. The result also indicates that a higher company income tax rate is associated with lower private investment and slower gross fixed capital formation. The implication of this finding is that since tax incentives represented by company income tax allowance and investment allowance have positive and significant impact on gross fixed capital formation, policy reform in other factors that affect investment growth is needed also to complement these incentives so that a better result can be achieved.

Keywords: Tax Incentives, Investment Growth, Corporate Income Tax, Investment Allowance

Background to the Study

Before the Nigerian Independence in 1960, the economy was basically dependent on Agriculture, employing a greater percentage of the population's workforce and contributing the greatest share of national GDP (NEEDS 2004). But from the late 1970s, oil became prominent and government shifted from Agricultural sector to oil sub-sector. Then the economy was open to the international communities and so much importation killed domestic manufacturing. With stiff competition from foreign firms, many domestic companies that could not compete with foreign companies closed down. In the early 1980s, oil prices collapsed in the international market, as a result, government revenue fell and domestic production of goods and services fall as well, government could not finance the importation of goods and services and as a result, unemployment and price of goods and services rose creating both internal and external imbalance.

As a result of this, some economic measures were undertaken to bring the economy back to a sustainable economic track. One of such economic measures is the tax reforms, so as to overcome the low output of goods and services, rising price of goods and high unemployment. The essence of tax incentives is to reduce the cost of production and stimulate output growth leading to the demand for domestic resources – (labour and raw materials).

Tax incentive can be defined as a deduction, exclusion or exemption from tax liability that is offered as an enticement to investors so as to encourage investment in certain preferred sectors of the economy for a certain period. Tax incentives according to Fletcher (2002) has been defined as any tax provision granted to a qualified investment project that represents a favorable deviation from the provisions applicable to investment projects in general. For example, any tax provision that sets the corporate income tax (CIT) rate for foreign invested enterprises (FIEs) at half the rate that applies to all domestic companies would constitute a tax incentive, but a provision that simply sets a low CIT rate for all firms would not constitute a tax incentive (Fletcher 2002).

Empirical studies like those of (Morisset 2003, Alan and Peter 2004 and Hoyt, Jepsen and Troske 2008) have reported different views on tax incentives as a catalyst for economic growth and development. One school of thought (Holland and Van 1996) believes that many developing and transitional countries in the world offer incentives for investment. This certainly relates to real investment in productive activities and are often directed to foreign investors on the ground that there is insufficient domestic capital that will bring the desired level of economic development and that international investment will always bring with it modern technology and management techniques, while another school of thought (Kwewuni 1996) believes that tax incentives by their nature represent revenue costs to the government and may be draining on the revenue of the government if not well focused. This is because government would have deprived itself of the revenue that would have been generated from tax.

The Government of Nigeria has put in place a number of investment incentives for the stimulation of private sector investment from within and outside the country. While some of these incentives cover all sectors, others are limited to some specific sectors.

It is not clear whether some of the measures taken so far by the government to improve the economy have really produced good results in terms of domestic investment growth rate, employment creation and output growth rate. This is because, with all these measures and policies taken so far, Nigerian economy has not shown any appreciable progress going by the review of the Gross Domestic Product (GDP) growth rate from 1985 - 2018. Years after the economic reforms, investment in industries is reducing, unemployment is increasing and domestic output has continued to stagnate. The question now is what are the effects of these incentives in the Nigerian economy if those problems have continued to linger after the introduction of these incentives? Nigeria still remains one of the developing nations. Given this gap, the study seeks to examine tax incentives and investment growth with evidence from Nigeria.

Objective

The Nigerian economy is not really doing very well, some companies are closing down and not very many are coming up. Apostles of tax incentives hold the view that tax incentives encourage investment growth while another school of thought believes that tax incentives reduce revenue to the government. They argued that tax incentives by their nature represent revenue loss to the government and may be draining on the revenue of the government if not well focused. Objective of this study is to assess the economic impact of tax incentives on investment growth in Nigeria.

Here the multiple regression was used to analyze the impact of tax incentives on the investment growth in Nigeria. This study used yearly data generated from Central Bank of Nigeria statistical bulletin, the Annual Abstract of the National Bureau of Statistics and the Federal Inland Revenue Service (FIRS) between 1985 and 2018.

Review of empirical literature

Klemm and Parys (2009) examined the Empirical Evidence on the Effects of Tax Incentives, considering two empirical questions about tax incentives: (1) are incentives used as tools of tax competition and (2) how effective are incentives in attracting investment? They prepared a new dataset of tax incentives in over 40 Latin American, Caribbean and African countries for the period 1985–2004. They used spatial econometrics techniques for panel data to answer the first question; they found an evidence for strategic interaction in tax holidays, in addition to the well-known competition over the corporate income tax rate and no evidence, however, for competition over investment allowances and tax credits. They used dynamic panel data econometrics to answer the second question and found evidence that lower corporate income tax rates and longer tax holidays are effective in attracting FDI, but not in boosting gross private fixed capital formation or growth. The finding that tax holidays are used as tool for tax competition and to affect FDI, while investment allowances do not seem to play a role in either case is interesting. There is also an interesting observation from their findings that the effect of tax rates and tax holidays on FDI, does not imply that there is an effect on total investment or economic growth.

Fletcher (2002) examined Tax Incentives in Cambodia, Lao PDR, and Vietnam. His purpose was to examine the effects of tax incentives in these countries on revenue and foreign direct investment. He did this via several means, including an examination of tax revenue and enterprise-level data in Vietnam, regional FDI trends, and regional cross-country relationships.

He observed that tax incentives schemes in Cambodia, Lao PDR (Lao People's Democratic Republic), and Vietnam share similar characteristics with each other. All three countries offer investors tax holidays of up to 8 years (although these are more rare in Lao PDR), reduced CIT rates, investment allowances or accelerated depreciation, and special exemptions from import duties and other indirect taxes.

All three countries also focus these incentives especially on foreign investors, exporters, and investments in poor regions. He found as follows; (1) Tax incentives can be costly; in the case of Vietnam, the cost may be in excess of 0.7 percent of GDP; (2) Tax incentives do not appear to be the primary determinant of investment; (3) There is little evidence that discriminatory tax incentives do a better job of promoting investment than simple, uniform regimes with low to moderate rates of taxation; indeed, if anything, the evidence indicates that the latter is preferable; and (4) If tax incentives are to be used, accelerated depreciation is likely to be more efficient and have fewer drawbacks than tax holidays.

Hoyt, Jepsen and Troske (2008), explored Business Incentives and Employment: What Incentives Work and Where? They evaluated the effect of tax and location-based incentives on employment using a panel data of Kentucky counties. They found the following; First, that there is evidence of positive and significant relationships between business incentives and employment, the significance and magnitude of these impacts depend on both the type of incentive and the location of the county. Secondly, that it appears that both training and tax incentives help attract firms that, in the absence of these incentives, would have located or expanded in neighboring states. They also found that, while tax incentives have a much larger impact on employment in MSA (Metropolitan Statistical Area) border counties, training incentives have a larger impact in non-MSA border counties. Finally, they found that there is little evidence of spillover effects from these incentive programs—the amount of incentives taken by firms in neighboring counties appears to have little impact on employment in a county.

Alan and Peter (2004) conducted a similar study on “the Failure of Economic Development Incentives”. The study used multiple regression analysis to analyze the failure of economic development incentives. The study showed that incentives will lead to business investment and thus new jobs, producing an increase in the local demand for goods and services, giving rise to further rounds of economic growth, and that economic growth increases public revenues, thus allowing for improved public services or a decline in tax rates.

Ogbonna and Appah (2012) examined the impact of tax reforms on Economic Growth in Nigeria: A Time Series Analysis. In their study, they used Time Series Data and employed co-integration tests to avoid spurious regression. The study also employed the Augmented Dickey - Fuller test for unit root. They also performed

Granger Causality test between the dependent and independent variables. The e-view software was used for the analysis of data. They found that tax reforms are positively and significantly related to economic growth and that tax reforms cause economic growth. However, they recommended that sustainable economic growth cannot be attained with tax reform processes except obsolete tax laws and rates are reviewed in line with macroeconomic objectives, corrupt-free and efficient tax administrative machinery with well trained personnel and accountability and transparency of government officials in the management of tax revenue.

Ohaka and Agundu, (2012) examined Tax Incentives for Industry Synergy in Nigeria. They adopted the survey approach method in their study to test how tax incentives affect return on equity. This was done by diagnosing two components of tax incentive (Investment Tax Credit and Re-Investment Allowance) Their analytical results clearly indicated a strong positive relationship between investment tax credit and return on equity; and this firmly establishes that investment tax credit is significantly associated with return on equity. Also, the coefficient of determination (R^2) implied that investment tax credit accounts for 96.1% of the variation in return on equity. Also in their finding is that there is a strong positive relationship between re-investment allowance and return on equity; and this firmly establishes that re-investment allowance is significantly associated with return on equity. The coefficient of determination (R^2) implied that re-investment allowance accounts for 98.9% of the variation in return on equity. Two components of tax incentives (Investment Tax Credit and Re-Investment Allowance) which were diagnosed in this study showed causally potent relationship with corporate financial performance (indicated by Return on Equity).

They recommended to the corporate executive and operative officers to: Invest in infrastructure modernization and expansion in order to upgrade critical technology, for the much-desired productive/competitive cutting-edge; Invest in training/retraining of critical human resources for more creative/innovative competencies; and Process and appropriate due benefits from tax incentives in accordance with relevant legislations, for utmost timeliness and effectiveness in auspicious utilization;

Worlu and Nkoro (2012) investigated Tax Revenue and Economic Development in Nigeria. In attempting to examine the impact of tax revenue on economic growth, they evaluated the time series features of the data by employing Augmented Dickey Fuller (ADF) and Philips-Perron(PP) to test for the unit root. They analyzed data collected using the three stage least square estimation technique. One major finding from their results is that tax revenue is indirectly related to foreign direct investment and real GDP through its impact on infrastructural development. The real GDP is significant though the sign is against apriori expectation as it presents with a negative rather than positive relationship with foreign direct investment. Also, foreign direct investment is with a contrary apriori sign and it is not significant. The interest rate, though with the wrong sign, is significant. Their recommendation was that for tax revenues to materialize its full potential on the economy, government will have to come up with fiscal laws and legislations and strengthen the existing ones in line with macroeconomic objectives, which will checkmate tax offenders in order to minimize corruption, evasion and tax avoidance and, improve the tax administrative machinery with personnel's and accountability and transparency of government officials in the management of tax revenue.

Peters and Kiabel (2015), conducted a study on "Tax Incentives and Foreign Direct Investment in Nigeria" the study examined the influence of tax incentives in the decision of an investor to locate FDI in Nigeria. Data were drawn from annual statistical bulletin of the Central Bank of Nigeria and the World Bank World Development Indicators Database. The work employs a model of multiple regressions using static Error Correction Modelling (ECM) to determine the time series properties of tax incentives captured by annual tax revenue as a percentage of Gross Domestic Product (GDP) and FDI. The result showed that FDI response to tax incentives is negatively significant, that is, increase in tax incentives does not bring about a corresponding increase in FDI. Based on the findings, the paper recommends, amongst others, that dependence on tax incentives should be reduced and more attention be put on other incentives strategies such as stable economic reforms and stable political climate.

Jean (2018) studied the Effect of Corporate Income Tax Incentives on Investment in Rwanda. The study adopted descriptive research design with a study population of thirty-nine manufacturing companies in free zone in Rwanda, the sample size comprised of 36 private companies. The Stratified random sampling technique was used

to select the respondents. The findings in his study revealed that tax incentives have significant positive effect on investment in private sector manufacturing companies in Rwanda. The study recommends that Government and policy makers should concentrate on efforts at ensuring that more CIT incentives and strategies that are specifically addressing small and medium enterprises are introduced.

UGWU, (2018), carried out a study on “Tax Incentives and Foreign Direct Investment (FDI): Implication for Export Promotion in Nigeria, Ghana and South Africa, Post IFRS Adoption”.

The study adopted Ex-post- facto research design. Secondary data were collected and analyzed using descriptive and inferential statistics. Findings revealed a positive association between tax incentives and FDI and that FDI had no significant effect on the exports of Nigeria, Ghana and South Africa. There was also, no significant difference in the effect of FDI on exports of all the countries of study in their pre and post-IFRS adoption periods. This implies that the more corporate tax rate is reduced, as well as increase in other tax incentives, the more FDI inflow into those countries and when significant level of FDI inflow have been achieved, the effect on export would become significant. One of the recommendations is that governments of the three countries of study should improve and sustain more tax incentives as that would help in the attraction of the much needed FDI in export oriented industries to enhance economic growth and development.

Daniel and Faustin (2019), carried out a study on the Effect of tax incentives on the growth of small and medium-sized enterprises (SMEs) in Rwanda; adopting the qualitative and quantitative research approach, with a population of 49000 SMEs from agricultural, industrial, services and tourism sectors operating in Nyarugenge district and a sample size of 136 SMEs was finally determined using Silovin and Yemen’s formula of sample size. The data set was analysed using descriptive statistics. A multiple regression analysis was used to explain the relation between variables. The study indicated that there was a strong positive and significant relationship between tax incentives and the growth of small and medium enterprises in Rwanda. The study concluded that tax incentives are the key to the sustainable growth of SMEs. The study recommended that government should design policies that specifically address issues related to the sustainable growth of SMEs.

Clearly, the finding in this literature, suggests that incentives may also be important. Most literature, have found a significant effect of tax incentives on investment growth, but uncertainty about its size remains. De Mooij and Edervén (2003) performed a meta-analysis of published results on this relationship and found a median semi-elasticity of FDI to the tax rate of -3.3 (implying that a 1 percentage point increase in the tax rate reduced FDI by 3.3 percent).

Shah (1995) examined the effect of tax incentives in a variety of countries, using different methodologies including calculations of METRs and business surveys. The overall conclusion from them is that tax incentives are often ineffectual, either because the particular incentives offered are not very valuable to firms or because important pre-conditions are not met, such as a relatively stable macroeconomic environment and satisfactory public infrastructure.

The impact of corporate taxes on economic growth has also been investigated extensively by some scholars. For example, Lee and Gordon (2005) used cross-country data ranging from 1970 to 1997 to investigate the impact of tax policies on a country's economic growth. Their study finds that increases in corporate taxes have a negative impact on economic growth. In fact, a ten percent reduction in the corporate tax rate will result in a one to two percent increase in the annual rate of growth. Similar conclusions about the impact of corporate taxes on economic growth are reached by Djankov, Ganser, McLiesh, Ramalho, and Shleifer (2008). Their cross-sectional study of 85 countries in 2004 indicates that corporate taxes have a large negative impact on aggregate investment and economic growth in countries under their empirical investigation.

Oyetunde (2008) also in his study on the role of tax incentives in a trio of Sub-Saharan African Economies, found out that, company income tax rates incentives were successfully used in Nigeria and have stimulated economic growth. Hines and Rice (2014) analyzed the effect of tax incentives on the foreign direct investment by comparing the inter-state distribution of investments with foreign investment in United State of America, using regression analysis, the results from the survey showed that high tax rates within the state are not good for the local

investment. Feldstein (2007) also analyzed the efficacy of tax incentives on investment, the result showed that investment allowance and investment tax credit are more simulative in its impact on private capital formulation. The study conducted by Bond and Xing (2013) on the effect corporate tax rate and depreciation allowances on the level of investment also revealed a significant effect on investment in assets.

However, Wheeler and Mody (2012), on International investment location decisions, had contradicting results from which they conclude that corporate taxes do not have a significant effect on FDI.

As discussed above many scholars in their studies have tried to show the effect of tax incentives on the level of investment growth, however, these views are not enough for policymakers rely on; we need empirical support of any policy we will want Nigeria to take. This paper has become part of the series of studies analyzing the effect of tax incentives on the investment growth in Nigeria so as to provide clue on contending issues and fill some research gap.

Theoretical framework

PRODUCTION THEORY: Several theoretical arguments have been advanced to support the assumption that tax incentives influence firm behavior. According to production theory, a reduction in the price of capital (due to tax incentives) triggers two effects. The first is an increase in output, a parallel drop in price of the good produced by beneficiary firms, and an increase in demand for both capital and labor. The second effect is a substitution of capital (the factor made relatively cheaper) for labor. The output and substitution effects work in the same direction for capital. Along the same lines, Papke and Papke (1984) argue that investment tax incentives increase liquidity and influence the timing of capital acquisition which encourages firms to retire and replace their plant and equipment more rapidly.

LOCATION THEORY: In addition to the production theory rationale, a well-developed branch of the economic literature known as LOCATION THEORY has argued that profit-maximizing firms choose the location that minimizes costs and thereby increases profits, all else being equal. Location theory was propounded by Johann Heinrich in his first volume of *Der Isolierte Staat* (partially translated as *Isolated State*) in 1826. This theory is concerned with the geographic location of economic activity; it addresses the questions of what economic activities are located where and why. Tax incentives influence a firm's cost function and its decision to locate within the jurisdiction of the awarding government. Some argue that tax incentives may also contribute to economic development because of their positive impact on business climate (J. A. Papke and Papke, 1984). The decision to locate investment in a specific area is made where it is considered that all other factors are relatively equal and hence tax incentives or tax differentials will have the greatest effect (Schmenner, 1982).

Methodology

In most of the developing countries in Africa, investment growth is influenced to a reasonable extent by external factors which may include exchange rate of the domestic currency against other currencies, trade openness, inflation, foreign direct investment and so many others. We measured investment growth as the ratio of gross fixed capital formation. This ratio is expected to be high and positively associated with global indicators. In Nigeria which is the study environment, the gross domestic product is not reflecting the expectations of the global world. Yearly data were generated from Central Bank of Nigeria statistical bulletin and the Federal Inland Revenue Service between 1985 which was the period the oil prices collapsed in the international market to 2018.

The econometric method was the most appropriate since we will be interested in model specification, measuring of the parameters of economic relationship.

The model equation is stated in Error Correction Form to establish whether there will be long run relationship between investment growth and tax incentives assuming linear relationship.

$$\text{Ln GFCF} = \beta_0 + \beta_1 \text{LnCITA}_t + \beta_2 \text{LnINVA}_t + \beta_3 \text{LnINTR}_t + \beta_4 \text{LnINFL}_t + \beta_5 \text{LnEXCH}_t + \text{et.} \dots 1$$

Where; Ln = Elasticity; β_0 = Constant and

β_i ($i = 1, 2, \dots, n$) = the parameters to be estimated

GFCF = Gross Fixed Capital Formation is used as proxy for investment,

Tax Incentives are represented by Company Income Tax and investment Allowance while the other variables are to moderate.

CITA = Company income tax,

INVA = Investment allowance

INTR = Interest Rate,

INFL = Inflation,

EXCH = Exchange Rate,

Company income tax allowance and investment allowance are chosen as proxy for tax incentives because they are general incentive for all companies. Their impact will be more in the economy because every company/firm in Nigeria will be affected and will benefit positively or negatively while all other tax incentives will only benefit foreign companies of which domestic companies will not benefit.

To transform our model for long-run analysis, an Error Correction Model (ECM) is specified thus:

$$\Delta \text{GFCF}_t = \beta_0 + \beta_1 \sum \Delta x_i + \lambda \text{ECM}_{t-1} \quad \dots \dots \dots \quad 2$$

Where,

ΔGFCF_t = differenced or stationarity level of gross fixed capital formation.

Δx_i = differenced exogenous variables in the model

β_0 = intercept

β_i = $\beta_1, \beta_2, \beta_3, \beta_4$ (slopes of the model)

λ = ECM parameter measuring the adjustment to previous equilibra achieved in the current period.

Other variables remain as defined before.

In this way GFCF is a measure of *gross net investment* (acquisitions less disposals) in fixed capital assets by enterprises, government and households within the domestic economy, during an accounting period such as a quarter or a year:

RESULTS

Dependent Variable: Gross Fixed Capital Formation

Pre-estimation Test

Table 1: Unit root test for stationarity:

Variables	ADF	1% Critical Value	5% Critical Value	Order of Integration
LnGFCF	-12.21	-3.50	-2.89	1(1)
LnACITA	-11.31	-3.50	-2.89	1(1)
LnINVA	-11.17	-3.50	-2.89	1(1)
LnINTR	-11.16	-3.50	-2.89	1(1)
LnINFL	-11.14	-3.50	-2.89	1(1)
LnEXCH	-11.49	-3.50	-2.89	1(1)

Source: *Analysis of Data*

Dick-Fuller test for Stationarity was presented in table 1 above, all the variables are stationary at 1st difference which shows that the mean and variance of the variables are constant over time.

DW= 0.214. The value of Durbin-Watson test suggests presence of Autocorrelation. The problem was corrected with the robust standard error as presented in table 4.

Table 2: Specification test

F-Statistics	422.59	Calculated	1%	5%
			4.5	3.23
F-Prob	0.000			

Source: *Analysis of Data*

The value of the calculated and critical 'F' in table 2 suggests that the model is well specified.

Table 3: Co-integration/Unit Root Test:

Variable	ADF	1%	5%
Residual	-0.56	-3.50	-2.89

Source: *Analysis of Data*

Cointegration between the dependent and independent variables is not suspected from the result presented in table 3, because the value of the residual (ADF = -0.56) is less than the 5% critical value. As a result, there is no long-run relationship between them. Therefore, the trend between the dependent and independent variables does not continue in the long-run. Thus, there is no need for error correction (ECM).

Table 4: Regression Result; Dependent Variable: Gross Fixed Capital Formation (LnGFCF-1)

Variables	Co-efficient	Robust Std error	't'c	P-value
CONST	8.837169	.3575994	24.71	0.000
LnCITA	.2609383	.0447997	5.82	0.000
LnINV A	-.0293068	.0068376	-4.29	0.000
LnINTR	-.0311423	.0094788	-3.29	0.001
LnINFL	.0058904	.0029338	2.01	0.047
LnEXCH	.0293337	.0048356	6.07	0.000

Source: *Analysis of Data*

$$R^2 = 0.9255$$

$$R^2_a = 0.9112$$

Statistical 1st-order Test:

The statistical 1st-order test is concerned about the significance of the independent variables in affecting the dependent variable. The student 't' test is the popular measure of test of significance in ordinary least square regression.

Table 5: Dependent Variable; Gross Fixed Capital Formation (GFCF)

Variables	't'c	t* 0.05	t* 0.01	Decision
Constant	24.71	2.04	2.75	XX
CITA	5.82	5.82	2.75	XX
INVA	-4.29	2.04	2.75	XX
INTR	-3.29	2.04	2.75	XX
INFL	2.01	2.04	2.75	NS
EXCH	6.07	2.04	2.75	XX

Source: *Analysis of Data*

XX = significant

NS = not significant

From the table above, all the variables except inflation are significant at either 1% or 5%.

Discussion of Finding

Table 4 above is the result of the effect of tax incentives on investment growth based on analysis with Nigerian data. Company income tax allowance, interest rate and exchange rate satisfied the a priori sign while investment allowance and inflation did not satisfy the a priori sign. The value of the Coefficient of Determination is 0.93 approximately, showing that the independent variables included in the model explained 93% of the changes in the investment growth of Nigeria within the study period. The explanatory power of the independent variables is high. The above result showed the relationship between tax incentive and investment growth. Company income tax allowance appeared with the correct sign while investment allowance did not. Economic theory posits that high company income tax allowance encourages domestic investment. Interestingly, both variables, company income tax and investment allowance are statistically significant. The explanatory power of the independent variables also shows that the independent variables account for 93 percent changes in the dependent variable.

The analytical outcome of this result is, therefore, in conformity with the submissions of many other researchers in the field of taxation accounting. Alan and Peter (2004) in particular contend that incentives will lead to business investment and thus new jobs. Djankov, Ganser, McLiesh, Ramalto, and Shleifer (2008), also indicates that corporate taxes have a large negative impact on aggregate investment and economic growth in countries under their empirical investigation. Asiodu (2003), in his study, showed that investment tax credit meaningfully promotes business performance, although the magnitude varies among countries, industries, and firm types. It helps to increase the profit prospects of new ventures and enables firms to recover capital costs more quickly. These costs, when recovered will eventually lead to reduced investment risks, thus consolidating firms' assets and working capital for strategic re-investments. Auerbach and Hines (1988) also affirmed that tax incentives critically redefine the financial performance of firms. Edame and Okoi (2014) are also in conformity to the expectation of this study, because their study showed that corporate income tax (CIT) appeared with a negative sign, this means that an inverse relationship exists between taxation and investment. The economic implication of the result is that a one percent (1%) increase in CIT will result in a decrease in the level of investment in Nigeria.

Looking at the result on investment in table 4, one can see that the effect of company income tax on gross fixed capital formation (gross domestic investment) is vividly clear as presented in table 4. The result is very interesting because it came out as expected. It shows that company income tax is very important in stimulating domestic investment. This is because tax is a cost in the production process and any policy that reduces the tax on firms equally reduces its cost of production. As cost of production is falling, every other thing remaining the same, firms will earn more profit. Increase in firms profit is an incentive to invest more.

Conclusion

The study so far shows that tax incentives (company income tax allowance and investment allowance) have significantly impacted on investment growth within the period of study. Corporate Income Tax Incentives have significantly affected investment growth positively in private sector manufacturing companies (Feldstein 2007 and Jean 2018). The present research has reinforced the findings of Feldstein and Jean that tax incentives have a significant positive effect on investment growth. However, the impact on investment growth is our major concern. Tax policy is a major determinant of other macroeconomic indices for both in developed and developing economies. Based on the reviewed literature, from lessons derived from international examples, there is hope that tax incentive policies in Nigeria, if prudently and selectively applied in conjunction with other economic policies, may well contribute to sustainable investment growth. However, tax incentive policy should be designed to protect domestic industries to stabilize and ready to compete with the external economies, this can be done by increasing import tariffs and also to attract investment in preferred sectors and achieve balance of payment equilibrium.

References

- Alan, P. and Peter, F. (2004), The Failures of Economic Development Incentives, *Journal of the American Planning Association*, Winter 2004, 70,(1) 2-3
- Asiodu, D.S. (2003), Industrial Policy and Incentives in Nigeria; *Nigeria Journal of Economic and Social Studies*. 2: 161-167.
- Auerbach, A.J. and J.R. Hines, (1988), "Investment Incentives and Frequent Tax Reforms," *American Economic Review* Vol. 78(2), 211–216.
- Auerbach A. J. (1998), The Cost of Capital and Investment in Developing Countries, in *Fiscal Incentives for Investment and Innovation*, 137-139;
- Bond, S., & Xing, J. (2013). Corporate taxation and capital accumulation. *Centre for Business Taxation, Working Paper No. 1015*.
- Daniel T. and Faustin G. (2019), Effect of tax incentives on the growth of small and medium-sized enterprises (SMEs) in Rwanda; *Journal of Accounting and Taxation*, Vol. 11(5), pp. 89-98, May 2019, ISSN 2141-6664, <http://www.academicjournals.org/JAT>
- De Mooij, R.A. and S. Ederveen, (2003), Taxation and Foreign Direct Investment: A Synthesis of Empirical Research, *International Tax and Public Finance* Vol. 10(6), 673–693.
- Djankov, S., Ganser, T., McLiesh, C., Ramalho, R., and Shleifer (2008), The Effect of Corporate Taxes on Investment and Entrepreneurship."Working Paper, *American Law & Economic Association Annual Meeting*, 2008
- Dwivedi D.N. (2004), Managerial Economics. 6th Edition, Vikas Publishing House PVT Ltd., New Delhi. 596P
- Edame G.E. and Okoi W. W. (2014), The Impact of Taxation on Investment and Economic Development in Nigeria, *Academic Journal of Interdisciplinary Studies*, MCSER Publishing, Rome-Italy Vol. 3 No. 4
- Feldstein, M. (ed.) (2007). *The effects of taxation on capital accumulation*. Chicago: University of Chicago Press.
- Fletcher K. (2002), Tax Incentives in Cambodia, Lao PDR, and Vietnam. *Prepared for the IMF Conference on Foreign Direct Investment: Opportunities and Challenges for Cambodia, Lao PDR and Vietnam Hanoi, Vietnam, August 4, 16-17*.
- Holland D. and R.J. Vann (1998): "Income tax incentives for Investment" *Tax design and drafting*, 2, 985-987
- Hoyt W. H., Jepsen C. and Troske K. R. (2008) Business Incentives and Employment: What Incentives Work and Where? *Institute for Federalism and Intergovernmental Relations (IFIR) Working Paper No. 2009-0*
- Jean B. H. (2018), Effect of Corporate Income Tax Incentives on Investment in Rwanda, *Journal of Management and Organizational Studies*, Vol. 5, No. 4; 2018, 1 ISSN 2330-5495 E-ISSN 2330-5509 , <http://mos.sciencedupress.com>
- Klemm, A., (2009), "Causes, Benefits and Risks of Tax Incentives," *IMF Working Paper 09/21 (Washington: International Monetary Fund)*.
- Klemm A. and Parys, S. (2009). Empirical Evidence on the Effects of Tax Incentives. *IMF Working Papers*; 9136(200). 1–25.
- Kuwuni, M. (1996): "A Critique of tax incentives in Nigeria" *Tax News*, 2 (1) 4-8
- Morisset J. (2003), Using Tax Incentives to Attract Foreign Direct Investment; *The world bank group, private sector and infrastructure network*.
- Morisset J. and N. Pirnia (2003); How Tax Policy and Incentives Affect Foreign Direct Investment: A Review' in Wells et al, Using Tax Incentives to Compete for Foreign Investment: Are They Worth the Costs? 85-87.
- OECD, 1996, "Tax Expenditure: Recent Experiences," Committee on Fiscal Affairs, OECD.
- OECD/AFDB, African Economic Outlook (2004) *105-Country Studies: Nigeria*, 373-375.
- Ogbonna G.N. and Appah E.(2012), Impact of Tax Reforms and Economic Growth of Nigeria: A Time Series Analysis. *Current Research Journal of Social Sciences* 4(1): 62-68
- Ohaka, J. and Agundu, U. C. (2012) Tax Incentives for Industry Synergy in Nigeria: A Pragmatic Proprietary System Advocacy; *African Research Review: An International Multidisciplinary Journal, Ethiopia Vol. 6 (3), Serial No. 26, July, 2012*
- Oyetunde S. O. (2008), The role of tax incentives in a trio of sub-Saharan African economies: A comparative study of Nigerian, South African and Kenyan Tax Law; A thesis submitted to the University of London for the degree of doctor of philosophy (PhD); *Centre for Commercial Law Studies*, Queen Mary University of London, England.
- Papke, J. A., and Papke, L. E. (1984). State tax incentives and investment location decisions: micro analytic simulations. In J. A. Papke (Ed.), *Indiana's revenue structure: Major components and issues Part II* (60-114). West Lafayette, Indiana: Purdue University, *Center for Tax Policy Studies*.
- Schmenner, R. W. (1982). *Making business location decisions*. Englewood Cliffs, NJ: Prentice Hall. 588P
- Shah A. (1995), Overview in *Fiscal Incentives for Investment and Innovation*, (Oxford University Press, New York: 1995), 2-5

- Wheeler, D., & Mody, A. (2012). International investment location decisions: The case for U.S. Firms. *Journal of International Economics*, 33(7), 57-76.
- Worlu C. N. and Nkoro E. (2012) Tax Revenue and Economic Development in Nigeria: A Macro econometric Approach *Academic Journal of Interdisciplinary Studies Published by MCSEER-CEMAS-Sapienza University of Rome; Vol 1 No 2 November 2012 ; ISSN 2281-3993*



The Influence of Demographic Attributes in the Implementation of Accrual-Based International Public Sector Accounting Standards

Charles K. Matekele¹, Gabriel V. Komba²

¹ Department of Accounting & Finance, Local Government Training Institute, Dodoma, Tanzania

² School of Business, Mzumbe University, Tanzania

Correspondence: Charles K. Matekele. Email: charles.matekele@lgti.ac.tz, or matekeleck@yahoo.com

Abstract

This research examined the influence of demographic attributes in the implementation of accrual-based IPSAS in the Local Government Authorities (LGAs) in Tanzania. The survey technique was employed to collect data from 150 accountants and auditors from seven LGAs. To explore the relationship between demographic attributes and implementation of accrual based IPSAS, multiple regression analysis was used. Gender, professional qualification and education level were found to have a positive significant influence while age and number of years of service in the LGAs had negative impact in the implementation of accrual based IPSAS. It is suggested that, decision and policy makers as well as accounting standards setters, should place much emphasize on individual accountants and auditors' capacity building and training. To improve accounting education, accrual based IPSAS should be part of the curriculum in universities and colleges. Employers must encourage accounting and auditing staff to attend professional seminars while improving their accounting knoweldge. Also, individual accountants and auditors should place much effort to attain professional certification like CPA or ACCA. Our study is limited by considering only 7 LGAs out 185 in United Republic of Tanzania. Other researches should be extended to the remaining LGAs

Keywords: Demographic Attributes, Accrual Based-IPSAS, Local Government Authorities, Tanzania

1. Introduction

This paper aims at examining the influence of demographic attributes in the Implementation of Accrual-based International Public Sector Accounting Standards (IPSAS). The origin of IPSAS traces its history since 1986 when the International Federation of Accountants (IFAC) introduced International Public Sector Accounting Standards Board (IPSASB) which used to be the Public Sector Committee (PSC). The PSC was one of the IFAC standing committees specialised to develop standards for the financial reporting in the public sector (Christiaens et al. 2015). The adoption and implementation of accrual based IPSAS in the public is among the most paramount aspects of New Public Financial Management. This requires transformation in the public sector financial reporting systems by establishing accrual accounting (Mbelwa et al. 2019; Rossi et al. 2016). The implementation of accrual based IPSAS calls for the greater financial transparency, accountability and

comparability in the public sector (Nakmahachalasint and Narktabtee 2019). In this sense, it is understood that a number of driving forces such as the wish to infuse more financial awareness into the decision-making system in the public sector and the demand to provide comprehensive, transparent, comparable, and reliable financial information to all stakeholders are the reasons behind adoption of accrual based IPSAS (Gomes et al. 2015). For this view, implementation of accrual based IPSAS allow users to assess the accountability for all resources the entity controls and the deployment of those resources. Stakeholders can assess the financial position, performance and cash flows and make decisions about providing resources to the reporting entity. In addition, accrual based IPSAS shows how an entity financed its activities and met its cash requirements either through exchange or non-exchange transactions. As the result it allows users to evaluate an entity's ongoing ability to finance its activities and to meet its liabilities and commitments. It is also useful in evaluating an entity's performance in terms of its service, costs, efficiency, and accomplishments (Christiaens et al. 2015b; Chanchani and Willett 2004).

Regardless of the best intended objectives of adoption of IPSAS, as evidenced above, developing countries have not harvested its desired outcome (Adhikari et al. 2019; Mbelwa et al. 2019). Previous studies have concentrated on the effects of adoption of IPSAS, harmonisation in the public sector financial reporting, legitimation of accrual accounting and transparency as well as accountability (Matekele and Komba 2019; Mbelwa et al. 2019; Miraj and Wang 2019; Mnif Sellami and Gafsi 2019; Muraina 2020; Kartiko et al. 2018; Baskerville and Grossi 2019). Other scholars have dedicated their studies on economic and institutional factors affecting implementation of accrual based IPSAS (Mnif Sellami and Gafsi 2019; Brusca et al. 2013; Iyoha and Owolabi 2012). These researches have attempted to provide answers to attractive and motivating questions despite the fact that, they have ignored the individual attributes of the accountants and auditors. Therefore, the question of how demographic factors influence implementation of accrual based IPSAS remains unanswered. The responses to this question is of major interest to various stakeholders such as development partners, accounting and auditing staff as well as decision and policy makers. To obtain answers to the raised question, the second section explores the existing literature on accrual based IPSAS implementation. The third section describes the methodology employed followed by the study findings. Conclusions and recommendations are provided under the last section.

2. Literature Review

Numbers of studies have examined the adoption and implementation of accrual-based IPSAS. This part aims at appraising previous researches related with implementation of accrual based IPSAS.

Jorge et al. (2019) emphasized that, for the goal of harvesting the desired fruits of accrual based IPSAS, consideration of main actors and drivers is inevitable. The attributes of actors such as education levels, professional certification and age drives implementation of accrual based IPSAS. Recognising this, Miraj and Wang (2019) and Tanjeh (2016) collectively concluded that provision of capacity building by offering IPSAS education and training to accounting and auditing staff assist in establishing a strong financial reporting system in public sector. Before these findings, Harun and Robinson (2010) documented that unskilled human resources and inadequate political support inhibited the implementation of accrual based IPSAS. On the other hand, presence of international pressure and economic crisis influenced the adoption of accrual based IPSAS.

Muraina (2020) reported the existence of significant and positive relationship between quality of financial reporting under IPSAS and accountability. This signifies that accountability levels in public sectors have been improved as the outcome of adoption of IPSAS. Similarly, Sukoharsono and Prihatiningtias (2018) found that, introduction of accrual accounting brings more accountability than cash accounting system. These studies ignored other related constructs such as demographic factors, corruption, faithful representation and comparability. Contrary to this, it was reported that, adoption of accrual based IPSAS doesn't necessary contribute to accountability since some reporting entities could reduce relevant issues in reporting (Grossi and Steccolini 2015).

While examining the variables affecting adoption and implementation of accrual based IPSAS, Agyemang and Yensu (2018) found presence of positive association between training as well education and implementation of IPSAS. This implies that capacity building to implementer's particularly accounting and auditing staff as well as decision makers facilitates effective implementation of accrual based IPSAS. Not interestingly, Mnif Sellami and Gafsi (2019) revealed that level of education had a negative influence on the implementation of accrual based IPSAS whereas extent of external openness and availability of external funding had positive and significant influence. Besides Agyemang and Yensu (2018) as well as Mnif Sellami and Gafsi (2019); Harun et al. (2019) added that, presence of inadequate qualified accountants and auditors limits the adoption and implementation of accrual based IPSAS in the Local and Central Governments.

Studies on the views of stakeholders in the implementation of accrual based IPSAS reports that, adoption and implementation of accrual based IPSAS is a favourable move towards public sector reforms (Gomes et al. 2015). They recognise that under external pressure and financial crises implementation of accrual based IPSAS is inevitable. They expect improvement in quality of public sector financial reporting. Apart from that, Fahmid et al. (2020) recommended that, developed countries and the World Bank should assess the capacity needs and financial reporting structures in developing countries. Once these needs are effectively addressed the adoption and implementation process will be fruitful. This indicates that, addressing the potential limitations like capacity development and availability of professionally qualified accountants in developing countries speed up the adoption process. Concurring with Fahmid et al. (2020); Tucker et al. (2019) concluded that, for the aim of improving public sector financial reporting, practical researches should be done to determine the required needs for the effective implementation of accrual based IPSAS.

Studying the legitimation of IPSAS in Spain, Brusca et al. (2013) discovered that credibility, code of law, political support and accountability contribute to the legitimation of accrual based IPSAS. To achieve the intended objectives of IPSAS combination of these factors contributes to the effective adoption and implementation of accrual based IPSAS. Supporting this, Harun et al. (2019), highlighted that for effective implementation of IPSAS, policy makers should consider the effects of cultural factors, consultation with academics and powers of politicians like councillors, members of parliament and mayors. This will add value in the transparency, accountability as well as fraud and corruption reduction. On top of that, standard setters and policy makers should encourage and support harmonisation of financial reporting in the public sector (Rossi et al. 2016).

3. Methodology

The objective of this study is to explore how demographic attributes affects implementation of accrual-based IPSAS. The sample for our study involved the 150 accountants and auditors from seven LGAs in Dodoma Region in the United Republic of Tanzania. A structured questionnaire was used to collect data from the respondents. Descriptive analysis and multiple regression analysis have been employed accompanied by Statistical Package for Social Science.

3.1. Operationalisation of the Research Variables

Implementation of accrual-based IPSAS constituted dependent variable which was operationalised by using three variables namely self-efficacy, competence and knowledge (Matekele and Komba 2019). We measured self-efficacy by using the items developed by Yakin and Erdil (2012). Such items were under a five point likert scale. These items were adopted and modified by the researcher in order to suit our study and to obtain respondents response regarding implementation of accrual based IPSAS. Multiple choice questions were employed to measure self assessment and competence of the respondents (Guney et al. 2017). Respondents were required to select the answer which most correctly describes their knowledge and competence on implementation of accrual based IPSAS in the LGAs. Demographic attributes as our independent variable was measured by six sub-variables namely gender, marital status, education level, age, years of service in the LGAs and professional qualification. We explored how these variables affects the implementation of accrual based IPSAS in the LGAs. The next subsections describe each of the demographic attributes and accompanied by hypotheses development.

3.1.1. Gender

Past research indicates that females are less likely to adopt and implement accrual based IPSAS than males (Tanjeh 2016). Apart from those findings, other authors show mixed findings on gender differences in job performance (Ahmad 2016; Azmi and Mohamed 2014). Some studies shows that no significant differences in the performance of males and females in terms of ability, altitude, commitment and effort (Yakin and Erdil 2012; Tanjeh 2016). Other studies show a disagreement with these findings. For example, Mir and Rahaman (2005) found a significant differences in the performance of males and females in the job. The research intends specifically to investigate the influence of gender in the implementation of accrual based IPSAS in the LGAs. To gain more insight from the LGAs, it is proposed that:

H1: Gender has a positive influence on Self efficacy

H2: Gender has a positive influence on Self assessment

H3: Gender has a positive influence on Self competence

3.1.2. Marital Status

The implementation of accrual based IPSAS in the LGAs may be influenced by the marital status. Traditional sociologists indicated that married women are not committed to their job. This means that married women with children are less committed to their work than men and single women (Gaffney et al. 1993; Anderson et al. 1994; Edeigba 2017). On the other hand, this finding shows that men and single women are more committed than married women in their work. This research examines the extent to which the stated argumentations above affects the implementation of accrual based IPSAS in the LGAs. Based on the facts presented above, we hypothesize that:

H4: Marital status negatively affects self efficacy

H5: Marital status negatively affects self assessment

H5: Marital status negatively affects self competence

3.1.3. Educational Level

Education is the leader for modern accounting system in the world. It was concluded that, a positive relationship exist between the level of education and professional accountants' competence (Zeghal and Mhedhbi 2006; Mir and Rahaman 2005). According to Edeigba (2017) and Tanjeh (2016) the weak level of education of employee prohibits implementation accrual based IPSAS. The implementation of accrual based IPSAS in the LGAs needs high education level, expertise and competent accountants and auditors (Zeghal and Mhedhbi 2006). Such persons can understand, interpret and apply the accrual based IPSAS in the LGAs. It is therefore logical to state that, LGAs in which education level is low and expertise is weak, there will be a real challenge to implement accrual based IPSAS. According to these arguments, the following hypotheses are developed:

H7: The level of education positively influences self efficacy

H8: The level of education positively influences self assessment

H9: The level of education positively influences self competence

3.1.4. Age

Previous study by Tanjeh (2016) found a negative correlation between age and the level of acceptance of accrual accounting. Moreover, Yakin and Erdil (2012) determined that older employees are lower likely to adopt a new change than younger workforce. Researcher's experience in the LGAs shows that younger accountants are highly committed in implementation of accrual based IPSAS than older accountants. In one of the LGAs training on IPSAS, the researcher noted that younger accountants are ready to understand and implement accrual based IPSAS than older accountants. Based on the reviewed literature and researcher's best knowledge and experience in LGAs training, we propose that:

H10: Age negatively influences self efficacy

H11: Age negatively influences self assessment

H12: Age negatively influences self competence

3.1.5. Years of Services in the LGAs

For the purpose of this study, years of service in the LGAs refers to the number of years in which a particular employee has been working with the LGAs. We expect a positive relationship between years of service in the LGAs and implementation of accrual based IPSAS in the LGAs. Basing on this, the researcher hypotheses are as follows:

H13: Years of service in the LGAs positively influences self efficacy

H14: Years of service in the LGAs positively influences self assessment

H15: Years of service in the LGAs positively influences self assessment

3.1.6. Professional Qualifications

For the purposes of this research, professional qualification means certification in terms of Certified Public Accountants (CPA) and any other professional certification in relation with accounting profession. Tanjeh (2016) and Yakın and Erdil (2012) discovered existence of positive association between professional certification and adoption level of accrual based IPSAS as well as job performance. In addition, Zeghal and Mhedhbi (2006) added that well trained and qualified accountants facilitate implementation of accounting standards. Basing on these literatures, professional qualification positively affects implementation of accrual based IPSAS in the LGAs. We developed the following hypotheses in order to test the relationship between professional qualification and implementation of accrual based IPSAS in the LGAs.

H16: Professional qualification positively affects self efficacy

H17: Professional qualification positively affects self assessment

H18: Professional qualification positively affects self competence

4. Results and Discussion

The following sub-parts, presents the descriptive statistics of demographic attributes, self competence and self assessment of the respondents; followed by multiple regression analysis.

4.1. Results for Demographic Characteristics

As stated earlier in this paper, demographic attributes as independent variable consists of six components namely gender, marital status, education level, age, professional qualification and number of years of service in the LGAs. As indicated in table 1.0, a total of 91 respondents (60.7%) are males. Most of the respondents are married (72.7%) while 88 respondents had bachelor degree in accounting representing 58.7%. In addition, 67 respondents (44.7%) are at the age group of 36-45. In terms of professional certification, large number of the respondents (105) equivalent to 70% doesn't have any professional qualification. For the number of years of service in the LGAs, large number of employees have working experience between 7 to 9 years. This represents 30% of the whole sample size. While 31.3% have 10 years and above as working experience.

Table 1. Demographic Characteristics of the Respondents

Variables	Category	Frequency	Percent
Gender	Male	91	60.7
	Female	59	39.3
	Total	150	100.0
Age	18-25	10	6.7
	26-35	47	31.3
	36-45	67	44.7

	46 and above	26	17.3
	Total	150	100
Marital Status	Single	34	22.7
	Married	109	72.7
	Divorced	7	4.7
	Total	150	100
Education Level	Certificate in Accounting	7	4.7
	Diploma in Accounting	7	4.7
	Bachelor degree in Accounting	88	58.7
	Masters degree	48	32
	Total	150	100
Professional Qualification	CPA	43	28.7
	ACCA	2	1.3
	Others(None of the above)	105	70
	Total	150	100
Number of Years of Service in LGAs	0-3 years	31	20.7
	4-6 years	27	18
	7 -9 years	45	30
	10 years above	47	31.3
	Total	150	100

4.2. Self Assessment and Competence of the Respondents

Self assessment and competence of the respondents were among the dependent variables used to measure implementation of accrual based IPSAS in the LGAs. A likert scale was used to measure self assessment and competence. Respondents' knowledge (self assessment) on implementation of accrual-based IPSAS shows that most of the respondents have fair knowledge on IPSAS implementation. Regarding the respondents self-competence on IPSAS implementation, results reveal that most of them have uncertain competence (refer to table 2.0)

Table 2. Self Competences and Assessment

Category: Self Competence	Frequency	Percent
Not competent	31	20.7
Somewhat competent	22	14.7
Uncertain	43	28.7
Competent	35	23.3
Highly competent	19	12.7
Total	150	100.0
Category: Self Assessment		
Moderately knowledgeable	20	13.3
Not knowledgeable at all	34	22.7
Fairly knowledgeable	43	28.7
Not very knowledgeable	33	22.0
Very knowledgeable	20	13.3
Total	150	100.0

4.3. Results for Multiple Regression

The objective of this study was to determine the influences of demographic attributes in the implementation of accrual based IPSAS in the LGAs. Implementation of accrual based IPSAS was measured by using three sub-variables namely self efficacy, assessment and competence. Demographic attributes constituted six sub-variables known as gender, age, marital status, education level, years of service in the LGAs and professional qualification of the respondents. In order to undertake multiple regression analysis, we recoded some of the demographic attributes into dummy variables. The next sections describe the results of multiple regression analysis.

a. Determinants of Self Efficacy

In Panel A (table 3.0), self efficacy has been involved as dependent variable in order to test the influence of demographic attributes in implementation of accrual based IPSAS in the LGAs. The regression model is significant statistically ($R^2=0.29$; $(F)=7.222$, $P<0.000$) and the association between independent variables as indicated by VIF and Tolerance is good. In addition; gender, age and number of years of service in the LGAs have been found to be significantly related to self efficacy. This means that positive relationship exist between gender and number of years of service in the LGAs while age has a negative association with self efficacy. Apart from that; marital status, education level and professional qualification have not been statistically significant with self efficacy.

Table 3. Determinants of Self Efficacy

PANEL A:	Independent Variable	Beta	t-value	Sig.	Tolerance	VIF
Dependent Variable:	Constant		3.63	0.00		
Self efficacy	Gender	0.15	1.96	0.05	0.92	1.09
	Age	(0.46)	(4.59)	0.00	0.54	1.86
	Marital Status	0.06	0.77	0.44	0.92	1.08
	Education level	0.02	0.26	0.79	0.79	1.27
	Professional qualification	0.08	1.05	0.30	0.97	1.03
	Number of years of service in LGAs	0.45	4.46	0.00	0.54	1.85
$R^2=0.29$ ANOVA $(F)=7.222$, $P<0.000$						

Also, we conducted stepwise estimation analysis and the results presented in table 4.0. According to our findings, the general model relationship is good ($R^2=0.58$, ANOVA $(F)=9.191$, $P<0.000$). Only one independent variable (Gender) has been found being statistical significant. This leads to acceptance of hypothesis H1 as shown in table 4.0

Table 4. Determinants of Self Efficacy: Stepwise Estimation

Construct	Beta	t-value	Sig.	Tolerance	VIF
Constant		21.55	0.00		
Gender	(0.24)	(3.03)	0.00	1.00	1.00
$R^2=0.58$, ANOVA $(F)=9.191$, $P<0.000$					

b. Determinants of Self Assessment

In Panel B (table 5.0), the regression model investigates the association between self assessment and demographic attributes in implementation of accrual based IPSAS. As indicated in the stated table, there is statistical significant in the regression model ($R^2=0.61$; $F=1.538$, $P<0.000$). No any problem with multicollinearity. Two variables namely education level and professional qualification show a significant relationship with self assessment. Education level has a positive significant impact whereas

professional qualification shows a negative significant impact with self assessment. The rest of the variables, have insignificant impact with self assessment. The insignificant impact is positive for age, marital status and negative for gender and number of years of service in the LGAs.

Table 5. Determinants of Self Assessment

PANEL B:						
Dependent Variable		Beta	t-value	Sig.	Tolerance	VIF
Self Assessment	Constant		3.25	0.00		
	Gender	(0.09)	(1.10)	0.27	0.92	1.09
	Age	0.15	1.32	0.19	0.54	1.86
	Marital Status	0.01	0.06	0.95	0.92	1.08
	Education level	0.12	1.34	0.02	0.79	1.27
	Professional qualification	(0.06)	(7.80)	0.01	0.97	1.03
	Number of years of service in LGAs	(0.02)	(0.18)	0.86	0.54	1.85
$R^2=0.61$ ANOVA (F)=1.538, $P<0.000$						

In addition, as indicated in table 6.0 stepwise estimation analysis was employed. Only one independent construct (age of the respondents) has been reported due to its statistical significance. Our findings are contrary to our proposition H11 (refer to table 6.0).

Table 6. Determinants of Self Assessment: Stepwise Estimation

Construct	Beta	t-value	Sig.	Tolerance	VIF
Constant		8.86	0.000		
Age	0.20	2.46	0.002	1.000	1.000
$R^2=0.39$, ANOVA (F)=6.048, $P<0.000$					

c. Determinants of Self Competence

For the purpose of testing the influence of demographic attributes in implementation of accrual based IPSAS in the LGAs; self competence has been considered as dependent variable (See Panel C in table 7.0). Our findings indicate a significant negative association between gender, professional qualification and number of years of service in the LGAs. However, age and marital status are not associated with self competence. In general, the regression model is statistically significant and no indication of multicollinearity problem with the outcomes ($R^2=0.122$; $F=3.306$, $P<0.000$).

Table 7. Determinants of Self Competence

PANEL C						
Dependent Variable	Independent Variable	Beta	t-value	Sig	Tolerance	VIF
Self Competence	(Constant)		5.41	0.00		
	Gender	(0.16)	(2.01)	0.05	0.92	1.09
	Age	0.05	0.50	0.62	0.54	1.86
	Marital Status	0.13	1.54	0.13	0.92	1.08
	Education level	(0.03)	(0.37)	0.07	0.79	1.27
	Professional qualification	(0.27)	(3.43)	0.00	0.97	1.03
	Number of years of service in LGAs	(0.03)	(0.33)	0.02	0.54	1.85
$R^2=0.122$, ANOVA (F)=3.306, $P<0.000$						

Finally, we also performed stepwise estimation and presented our results in table 7.0. Three independent variables namely professional qualification, education level and gender of the respondents show statistical significance with regression model. Review of the VIF and Tolerance reveals absence of multicollinearity problem. In line with our predictions, the researcher hereby accepts three hypotheses which are H3, H9 and H18 (see table 8.0).

Table 8. Determinants of Self Competence: Stepwise Estimation

Construct	Beta	t-value	Sig.	Tolerance	VIF
Constant		22.07	0.00		
Professional Qualification	0.26	3.29	0.00	1.00	1.00
Education level	0.28	3.56	0.00	0.99	1.01
Gender	0.19	2.42	0.00	0.99	1.01
$R^2=0.68$, ANOVA (F)=8.52, $P<0.000$					

4.4. Discussion of the Findings

The researcher intended to examine how demographic attributes such as gender, marital status, education level, age, professional qualification and years of service in the LGAs influences implementation of accrual based IPSAS in the LGAs. Basing our objective, we conducted multiple regression analysis followed by stepwise estimation analysis. The next subparts describe our results.

4.4.1. Self efficacy and Demographic attributes

We generated six hypotheses in this part as stated under section three. According to our findings, there is a significant positive relationship between gender and self efficacy. This means that gender differences significantly influences self efficacy. Our results indicates that, female are more self efficacy than males. This means that, females are more capable to implement accrual based IPSAS than males. These results are contrary to previous studies which indicate that males are highly efficacy than females in adoption and implementation of accrual based IPSAS (Ahmad 2016; Yakın and Erdil 2012).

4.4.2. Self assessment and Demographic Attributes

Our findings are against hypothesis (H11) in the sense that, a positive relationship exists between age and self assessment. Statistically, such relationship is significant (see table 5.0). The rest of demographic attributes don't have significant association with self assessment in implementation of accrual based IPSAS.

4.4.3. Self Competence and Demographic Attributes

According with our findings, there is existence of significant positive relationship between gender, professional qualification and education level and self competence in implementation of accrual based IPSAS. Such positive impacts are consistent with hypotheses H3, H9 and H18. Review of past studies indicate that, the existence of positive association between education and professional qualification in implementation of IPSAS (Edeigba 2017; Ahmad 2016; Tanjeh 2016). In addition, age and marital status were found not to have any impact with self competence. Hence hypotheses H13.3 and H6 rejected.

5. Conclusions and Recommendations

The study intended to examine the influences of demographic factors in implementation of accrual based IPSAS in the LGAs. According to our findings gender, professional qualification and education level were found to have a positive significant influence while age and number of years of service in the LGAs had negative impact in the implementation of accrual based IPSAS in the LGAs. These outcomes recommend that, decision and policy makers as well as accounting standards setters, should place much emphasize on individual accountants and auditors' capacity building and training. Employers must encourage accounting and auditing staff to attend professional seminars while improving their accounting knoweldge. Also, individual accountants and auditors should place much effort to attain professional certification like CPA or ACCA. In addition, universities and colleges should include accrual based IPSAS in their curriculum for the aim of improving accounting education in Tanzania and beyond. On the other hand, our study is limited by considering only 7 LGAs out 185 in United Republic of Tanzania. Other researches should be extended to the remaining LGAs while employing other means of data collection apart from the structured questionnaire.

References

- Adhikari, Pawan; Kuruppu, Chamara; Ouda, Hassan; Grossi, Giuseppe; Ambalangodage, Dayananda (2019): Unintended consequences in implementing public sector accounting reforms in emerging economies. Evidence from Egypt, Nepal and Sri Lanka. In *International Review of Administrative Sciences*,
- Agyemang, Joseph Kwasi; Yensu, Joseph (2018): Accrual-Based International Public Sector Accounting Standards. Implementation Challenges Facing the Metropolitan, Municipal and District Assemblies in the Ashanti Region of Ghana. In *Jurnal Akuntansi* 8 (2).
- Ahmad, Nurul Nadiah (2016): Investigating the factors influencing users' resistance towards accrual accounting. In *Procedia Economics and Finance* 35, pp. 17–26.
- Anderson, John C.; Johnson, Eric N.; Reckers, Philip M. J. (1994): Perceived effects of gender, family structure, and hysical appearance on career progression in public accounting. A research note. In *Accounting, Organizations and Society* 19 (6), pp. 483–491.
- Azmi, Azrina Hani; Mohamed, Nafsiah (2014): Readiness of Malaysian public sector employees in moving towards accrual accounting for improve accountability. The case of Ministry of Education (MOE). In *Procedia-Social and Behavioral Sciences* 164, pp. 106–111.
- Baskerville, Rachel; Grossi, Giuseppe (2019): Glocalization of accounting standards. Observations on neo-institutionalism of IPSAS. In *Public Money & Management* 39 (2), pp. 95–103.
- Brusca, Isabel; Montesinos, Vicente; Chow, Danny S. L. (2013): Legitimizing international public sector accounting standards (IPSAS). The case of Spain. In *Public Money & Management* 33 (6), pp. 437–444.
- Chanchani, Shalin; Willett, Roger (2004): An empirical assessment of Gray's accounting value constructs. In *The International Journal of Accounting* 39 (2), pp. 125–154.
- Christiaens, Johan; Vanhee, Christophe; Manes-Rossi, Francesca; Aversano, Natalia; van Cauwenberge, Philippe (2015a): The effect of IPSAS on reforming governmental financial reporting. An international comparison. In *International Review of Administrative Sciences* 81 (1), pp. 158–177.
- Edeigba, Jude (2017): An Investigation of the challenges in International Financial Reporting Standards' adoption. Evidence from Nigerian publicly accountable companies: Lincoln University.
- Fahmid, Imam Mujahidin; Harun, Harun; Graham, Peter; Carter, David; Suhab, Sultan; An, Yi et al. (2020): New development. IPSAS adoption, from G20 countries to village governments in developing countries. In *Public Money & Management* 40 (2), pp. 160–163.
- Gaffney, Mary Anne; McEwen, Ruth Ann; Welsh, Mary Jeanne (1993): Gender effects on commitment of public accountants. A test of competing sociological models. In *Advances in Public Interest Accounting* 5 (1), pp. 45–73.

- Gomes, Patrícia S.; Fernandes, Maria José; Carvalho, João Baptista Da Costa (2015): The international harmonization process of public sector accounting in Portugal. The perspective of different stakeholders. In *International Journal of Public Administration* 38 (4), pp. 268–281.
- Grossi, Giuseppe; Steccolini, Ileana (2015): Pursuing private or public accountability in the public sector? Applying IPSASs to define the reporting entity in municipal consolidation. In *International Journal of Public Administration* 38 (4), pp. 325–334.
- Guney, Yilmaz; Kallinterakis, Vasileios; Komba, Gabriel (2017): Herding in frontier markets. Evidence from African stock exchanges. In *Journal of International Financial Markets, Institutions and Money* 47, pp. 152–175.
- Harun, Harun; Mir, Monir; Carter, David; An, Yi (2019): Examining the unintended outcomes of NPM reforms in Indonesia. In *Public Money & Management* 39 (2), pp. 86–94.
- Harun, Harun; Robinson, Peter (2010): The adoption of accrual accounting in the Indonesian public sector. In *Research in Accounting in Emerging Economies* 10, pp. 233–250.
- Iyoha, F. O.; Owolabi, Akintola (2012): Adopting international financial reporting standards (IFRS) in Africa. Benefits, prospects and challenges. In *African J. Accounting, Auditing and Finance* 1 (1).
- Jorge, Susana; Brusca, Isabel; Nogueira, Sónia P. (2019): Translating IPSAS into national standards. An illustrative comparison between Spain and Portugal. In *Journal of Comparative Policy Analysis: Research and Practice* 21 (5), pp. 445–462.
- Kartiko, Sigit Wahyu; Rossieta, Hilda; Martani, Dwi; Wahyuni, Trisacti (2018): Measuring accrual-based IPSAS implementation and its relationship to central government fiscal transparency. In *BAR-Brazilian Administration Review* 15 (4).
- Matekele, Charles K.; Komba, Gabriel V. (2019): Factors Influencing Implementation of Accrual Based International Public Sector Accounting Standards in Tanzanian Local Government Authorities. In *Asian Journal of Economics, Business and Accounting*, pp. 1–25.
- Mbelwa, Latifa Hamisi; Adhikari, Pawan; Shahadat, Khandakar (2019): Investigation of the institutional and decision-usefulness factors in the implementation of accrual accounting reforms in the public sector of Tanzania. In *Journal of Accounting in Emerging Economies*.
- Mir, Monir Zaman; Rahaman, Abu Shiraz (2005): The adoption of international accounting standards in Bangladesh. In *Accounting, Auditing & Accountability Journal*.
- Miraj, Javed; Wang, Zhuquan (2019): Factors Influencing the Implementation of International Public Sector Accounting Standards in Pakistan. In *International Journal of Business and Management* 14 (9).
- Mnif Sellami, Yosra; Gafsi, Yosra (2019): Institutional and economic factors affecting the adoption of international public sector accounting standards. In *International Journal of Public Administration* 42 (2), pp. 119–131.
- Muraina, Saheed Adekunle (2020): Effects of implementation of International Public Sector Accounting Standards on Nigeria's financial reporting quality. In *International Journal of Public Sector Management*.
- Nakmahachalasint, Orphan; Narktabtee, Kanogporn (2019): Implementation of accrual accounting in Thailand's central government. In *Public Money & Management* 39 (2), pp. 139–147.
- Rossi, Francesca Manes; Cohen, Sandra; Caperchione, Eugenio; Brusca, Isabel (2016): Harmonizing public sector accounting in Europe. Thinking out of the box. In *Public Money & Management* 36 (3), pp. 189–196.
- Sukoharsono, Eko Ganis; Prihatiningtias, Yeny Widya (2018): Public interest and accrual accounting. Are they aligned? In *Journal of Accounting & Organizational Change*.
- Tanjeh, Mukah Samuel (2016): Factors influencing the acceptance of international public sector accounting standards in Cameroon. In *Accounting and Finance Research* 5 (2), pp. 71–83.
- Tucker, B.; Ferry, L.; Steccolini, I.; Saliterer, I. (2019): The practical relevance of public sector accounting research; time to take a stand—A response to van Helden. In *Public Money & Management*.
- Yakin, Mustafa; Erdil, Oya (2012): Relationships between self-efficacy and work engagement and the effects on job satisfaction. A survey on certified public accountants. In *Procedia-Social and Behavioral Sciences* 58, pp. 370–378.
- Zeghal, Daniel; Mhedhbi, Karim (2006): An analysis of the factors affecting the adoption of international accounting standards by developing countries. In *The International Journal of Accounting* 41 (4), pp. 373–386.



Does Pecking Order Theory Hold Among Kenyan Firms?

Douglas M. Wanja¹, Peter W. Muriu²

¹School Business and Economics Kisii University. E-mail: douglas.wanjam@gmail.com

²School of Economics, University of Nairobi. E-mail: pmuriu@gmail.com

Correspondence: Douglas M. Wanja. Email: douglas.wanjam@gmail.com

Abstract

This study examined the pecking order theory of capital structure through annual data of 37 firms listed at the Nairobi Securities Exchange for the period 2011-2016. Estimation results established a positive relationship between changes in debt and investments and a negative relationship between changes in debt and cash flows. Overall, the findings suggest that financial deficits determine net debt issues and hence a strong case for pecking order theory in Kenya in explaining capital structure decisions.

Keywords: Pecking Order Theory, Capital structure; Financing deficit, Panel Data

JEL: G32

1. Introduction

According to the pecking order theory (POT), firms prefer internal sources of finance to external sources of finances (Myers, 1984). This is mainly because internal sources of finance are less prone to costs of information asymmetry unlike the external sources of finance. Hence, firms opt for retained earnings first to finance their operations. If the retained earnings are insufficient, then firms borrow to bridge the deficit. In the event that deficit persists, firms then issue equity to raise funds as the last resort. Put differently, there exists a hierarchy of financing business operations.

Empirical evidence on POT finds contrasting results, which emanates from different statistical powers (Leary & Roberts, 2004). Studies by Rajan and Zingales (1995), Titman and Wessles (1988), and Fama and French (2002) established a negative relationship between profitability.

Using a simple regression model, Shyam-Sunders and Myers (1999) concluded that POT provides a good way of examining financial structure behavior. But these findings were rebutted by Chirinko and Singha (2000) who showed that the hypothesis used by Shyam-Sunders and Myers (1999) suffered from statistical power problems that may have invalidated their inferences. Frank and Goyal (2003) highlighted that Shyam-Sunders and Myers' model showed that POT fails for small firms. However, Fama and French (2003) found that large firms still violate the financing hierarchy. Lemmon and Zender (2003) showed that as long as firms were able to account

for financial slack, then Frank and Goyal hypothesis would hold. Nevertheless, Shyam-Sundars and Myers' model still suffers from statistical power¹ problems.

One important gap in the 'capital structure' strand of literature, which has been less analyzed, is the extent to which Kenyan firms adopt POT in making financing decisions. Studies conducted in Kenya have focused more on factors that determine capital structure in general, financing behaviors and performance across different industries and sectors (see for example (Ngugi, 2008) who investigated POT with reference to Kenyan firms but whose focus was on the influence of profitability on capital structure. This study, therefore, seeks to fill this research gap. Thus, we investigate the extent to which the POT of capital structure provides a satisfactory account of the financing behavior of publicly traded firms over the 2011 to 2016 period.

2. Previous Evidence

Capital structure theory dates back to 1958 with MM's position that the value of a firm is independent of capital structure. In short, the capital structure was irrelevant. This would later change in 1963 when M&M incorporated debt that brought in tax implications and hence affected the value and performance of the firm (Ukaegbu, 2015). Durand (1959) questioned how applicable arbitrage was and termed the assumptions made by M&M as unrealistic. However, as alluded to by Muriu (2016), increasing the use of debt monotonically would result in increased bankruptcy costs and mostly when a firm's profits are low and cyclical. With later evolution of the trade-off proponents, the academic discourse shifted from the static to dynamic trade-off propositions and this provided a foundation for the POT as known today.

The POT theory has been tested under both the developed and developing economies. Some of the studies that have tested this theory include Jiran et al. (2012) who tested the POT in Pakistan using non-financial firms using panel-data regression analysis for the period 2001-2008. They found that firms in Pakistan follow the POT. Matemilola et al. (2012) also tested the trade-off theory against the POT in a nested model-using panel, Generalized Method of Moment (GMM) estimation techniques in South Africa. Results from the GMM indicated that fixed assets and profits are key determinants of capital structure. From the empirical results, it was established that the trade-off theory and POT were compatible in a nested model. Ramjee (2012) using a sample of 178 firms listed with JSE estimated a target adjustment model using a generalized method of moments technique to determine the cost and speed of adjustment towards a target debt ratio. The study found that firms in South Africa follow both the trade-off theory and POT in determining capital structure. Chen and Jung studied how POT explains capital structure in Taiwan. They investigated POT using 305 Taiwan electronic companies quoted in the Taiwan Stock Exchange (TSE) of 2009. They used a hierarchical regression model of estimation. They found that profitability and firm growth rate to be key determinants of capital structure with profitability having a negative relationship with capital structure and growth rate a positive relationship. This study aims to test the POT in the Kenyan firms' context.

Extensive literature has focused on country-specific studies. These include China (), South Africa (Negash, 2002), Zimbabwe, (Green and Mutenheri, 2002) Kenya, (Ngugi, 2008; Nyang'oro, 2003) and Ghana, (Abor and Biekpe, 2005) while some have focused on regions (De jong et al. 2008). These prior studies examined the role of asset tangibility, profitability, firm size and growth, business risk, management composition, tax rate, among others without controlling for other macroeconomic factors such as interest rates.

Large profitable firms have been found to prefer less debt in their financing structure and hence the negative relationship between leverage and profitability (Kester, 1986; Harris and Raviv, 1991; Rajan and Zingales, 1995; Albert and Addie, 2002). The cost gap between internal and external sources of finance explains these preferences (Yegon et. al., 2014). By controlling for debt capacities of the firms, Lemmon and Zender (2008), finds that the POT holds.

¹ Statistical power of a study (sometimes called sensitivity) is how likely the study is to distinguish an actual effect from one of chance. It's the likelihood that the test is correctly rejecting the null hypothesis.

On a similar vein but for Ghanaian firms (Abor 2008) concluded that quoted and unquoted firms had larger debt ratios than the SMEs. This confirms that large firms are likely to use more debt. The study also found that firm size, asset structure, profitability, and management structure are key determinants of capital structure decisions in Ghana.

Studies such as Fama and French (2002), Frank and Goyal (2003), Fama and French (2005), and Leary and Roberts (2007), question the ability of POT to explain financing decisions. Frank and Goyal (2003) for instance allude that the model by Shyam-Sunders and Myers (1999) fails to hold for small-high-growth firms as these firms issue more equity than debt. Fama, French (2005) supported their position, and this contradicts the POT. In Australia, Allen (1991) tested the financial perceptions of the managers on capital structure decisions. Field interviews were conducted on secretaries and senior financial offices for 48 listed firms. The results indicated that firms follow the POT.

There are a few studies in Kenya with a focus on POT. Ngugi's (2008) findings supported a pecking order model that incorporated a speed of adjustment and in the study, non-debt tax shields, asymmetric information, and local capital market infrastructure greatly influenced financing behaviors.

Pettit and Singer (2005) also found that POT was relevant for firms in the manufacturing sector because the cost of internal financing was higher for them than for large firms.

On a related development, Njoroge and Nasieku (2016) investigated the determinants of the capital structure of internet service providers in Kenya. They established that firm growth, the tangibility of assets, profitability and liquidity had a significant effect on levels of leverage. They found the growth of the firm, profitability and asset tangibility to have a positive relationship with leverage while liquidity and size of the firm had a negative relationship with debt. These findings were consistent with Panno (2003), Eriotis et al. (2009), Sheikh, and Wang (2011). Moreover, Sheikh and Wang (2011), Ukaegbu and Oino (2013), found a negative relationship between capital structure and liquidity, which confirmed the postulates of the POT that firms prefer internal financing to external financing while making capital structure decisions.

Firms in South Africa adjust fast towards target debt ratios. Using 178 firms listed on the Johannesburg Stock Exchange (JSE henceforth) for the period 1998-2008, (Ramjee, 2012) established that asset tangibility, growth, size, and risk are positively related to leverage, while profitability and tax are negatively related to capital leverage. Moreover, some firms with a greater proportion of tangible assets had higher debt ratios, while more profitable firms operated at lower levels of leverage, other firms operated at higher levels leverage, and that fast-growing firms prefer debt to equity when raising their capital. The study also found that prefer internal to external sources of finance-to-finance their operations which is consistent with POT in their financial decisions. Using a sample of 49 companies both in industrial and service industries in Kuwait, Gharaibeh (2015) investigated the determinants of capital structure for the period 2009 to 2013. The study results indicated that growth opportunity, firms' age, liquidity, profitability, size, tangibility, and industry type have a statistically significant relationship with the firm's choice of leverage. Moreover, the study established that that firm's age, growth opportunities, liquidity, profitability, firm's size, tangibility, and type of industry are key determinants of capital structure.

While studying the effect of capital structure on the financial performance of Small and Medium Enterprises (henceforth SMEs), Mirie and Birundu (2015) used multiple linear regression and established that capital structure, asset turnover, and tangibility had no significant effect on the financial performance of SMEs.

Inconsistent findings were established by Murray and Vidham (2002) by testing US-listed firms for the period 1971 and 1998 and found that firms actually employed equity more than debt hence contradicting POT which supports Graham (2000).

Frank and Goyal (2003) consider omitting variables that determine leverage while estimating the pecking order model an error. However, this study only focused on the POT model as defined by changes in financial deficit.

Do these initial findings suggest with regard to POT? And in Kenya? What is the knowledge gap and how will this study fill the gap?

However, this study aimed not only at looking at whether the pecking order explains capital structure decisions in Kenya but also used a more current study period 2011-2016 in order to draw valid and current inferences. A lot has changed in the Kenyan financial sector. Key changes included increased financial liberalization and capping of interest rates by the Central Bank of Kenya. Hence, it was interesting to test POT and see if it stood its initial hypothesis. It was also clear that the majority of the studies have conducted descriptive and regression analysis using GMM among other modeling techniques. This study was different and was modeled using Shyam-Sunder and Myer's (1999) model to empirically test pecking other theories for the Kenyan case.

3. Methodology

3.1 Theoretical framework

According to Shyam-Sunder and Myers (1999), firms prefer internal financing first to external finances. Firms use retained earnings first and then debt and equity in that order. This defines a hierarchy of financing in the capital structure. They based their model on two assumptions. First, the existence of an internal financing deficit determined the amount of debt financing a firm opted for. Thus, the internal finance deficit gap determined the amount of debt to fill this gap. Secondly, they assumed that the amount of debt used to fill the internal finance deficit gap should also minimize the costs of information asymmetry. Hence, if POT applies, the optimal level of debt applied is solely due to the existing internal financing deficit.

Moreover, stock markets such as the NSE have so much information asymmetries and this determines the different factors that determine capital structure empirical models adopted by firms (Stiglitz, 1998).

The study focused on testing the validity of the following hypothesis:

H₀: Firms listed with NSE do not follow POT in making the capital structure decisions

H₁: Firms listed with NSE follow POT in making the capital structure decisions

Shyam-Sunders and Myers (1999) came up with a simple regression model. In this model, they believed that the net debt issue (ΔD_{it}) and financial deficit (DEF_{it}) had a positive relationship as illustrated by equation 1, which represents the pecking-order model.

$$\Delta D_{it} = \alpha + \beta_1 DEF_{it} + \varepsilon_{it} \dots \dots \dots (1)$$

Where α and β_1 are constant parameters. Equation 1, β_1 represents the POT coefficient, ε_{it} which is the error term, while the subscripts i and t represent the firm's number and time respectively. For POT to strictly apply $\beta_1 = 1$ and $\alpha = 0$. This implies that the amount of debt issued by a firm is equivalent to the existing deficit gap.

Shyam-Sunders and Myers (1999) alluded that the following simple aggregated model defines the financial deficit (See Khan et al, 2015).

$$DEF_{it} = DIV_{it} + I_{it} + \Delta WC_{it} + R_{it} - CF_{it} = \Delta D_{it} + \Delta E_{it} \dots \dots \dots (2)$$

Where;

DIV_{it} : Cash dividends for firm i in year t

I_{it} : Net investment for firm i in year t (i.e. I_{it} = capital expenditures + increase in investments + acquisitions + other use of funds – sale of PPE – sale of investments). This referred to as capital expenditure in the existing literature.

ΔWC_{it} : Change in working capital for firm i in year t (ΔWC_{it} = change in operating working capital + change in cash and cash equivalents + change in current debt)

R_{it} : Current portion of long-term debt firm i in year t

CF_{it} : Cash flow after interest and taxes for firm i in year t (CF_{it} = income before extra-ordinary items + depreciation and amortization + extraordinary items and discontinued operations + deferred taxes + equity in net loss – earnings + other funds from operations + gain (loss) from sales of PPE and other investments).

ΔD_{it} : Net debt issued for firm i in year t (ΔD_{it} = long-term debt issuance – long-term debt reduction)

ΔE_{it} : Net equity issued firm i in year t (ΔE_{it} = common stock sales – stock repurchases)

Frank and Goyal (2002) modified equation 2 as follows:

$$DEF_{it} = DIV_{it} + I_{it} + \Delta WC_{it} - CF_{it} = \Delta D_{it} + \Delta E_{it} \dots \dots \dots (3)$$

Where, they omitted the current portion of long-term debt (R_{it}) variable which according to them, had no significant effect on the overall results (Liu, 2013). This represents the disaggregated model.

3.2 Empirical Model

This study used the Shyam-Sunders and Myers (1999) aggregated model to test for POT among firms in Kenya. The simple POT regression model seeks to test if a change in internal financial deficits implies net debt issues and specified as;

$$\Delta D_{it} = \alpha + \beta_1 DEF_{it} + \varepsilon_{it} \dots \dots \dots (4)$$

The model is further augmented to explain the changes in both debt issues and internal financial deficits and specified as;

$$DEF_{it} = DIV_{it} + I_{it} + \Delta WC_{it} - CF_{it} = \Delta D_{it} + \Delta E_{it} \dots \dots \dots (5)$$

Consistent with Gachoki (2005), we compute average internal deficit values for each individual firms as follows;

$$DEF_{it} = \frac{\sum_{i=1}^n DEF_{it}}{n} \dots \dots \dots (6)$$

Computing average net debt issues, we obtain;

$$\Delta D_{it} = \frac{\sum_{i=1}^n \Delta D_{it}}{n} \dots \dots \dots (7)$$

$$\text{Similarly, we can get net equity issues and obtain; } \Delta E_{it} = \frac{\sum_{i=1}^n \Delta E_{it}}{n} \dots \dots \dots (8)$$

Hence, the POT regression model is specified as;

$$\frac{\sum_{i=1}^n \Delta D_{it}}{n} = \alpha + \beta_1 \frac{\sum_{i=1}^n DEF_{it}}{n} + \varepsilon_{it} \dots \dots \dots (9)$$

If POT holds, then $\alpha=0$ and $\beta_1=1$. Since DEF defines ΔD , then equation 10 is specified as;

$$\Delta D_{it} = \alpha + b_1 DIV_{it} + b_2 I_{it} + b_3 \Delta W_{it} - b_4 \Delta C_{it} + \varepsilon_{it} \dots \dots \dots (10)$$

Under the POT, while holding all other factors constant, change in DEF implies a change in ΔD . Therefore,

$$b_1 = b_2 = b_3 = b_4 = 1$$

3.3 Definition and Measurement of Variables

Data were obtained from annual reports, financial and cash flow statements of all firms that consistently traded with NSE for the period 2011-2016.

The dependent variables are ΔD_{it} and DEF_{it} specified as follows;

$$\Delta D_{it} = \alpha + \beta_1 DEF_{it} + \varepsilon_{it} \dots \dots \dots (11)$$

$$DEF_{it} = DIV_{it} + I_{it} + \Delta WC_{it} - CF_{it} = \Delta D_{it} + \Delta E_{it} \dots \dots \dots (12)$$

The dependent variable (ΔD_{it}) represents the net debt issues by a firm. According to POT, ΔD_{it} should change commensurately with changes in internal financial deficit (DEF_{it}) implying that $\alpha=0$ and $\beta_1=1$.

The independent variable (DEF_{it}) represents the internal financial deficit which was derived from published financial statements.

ΔWC_{it} = This represents changes in working capital for firm i in year t and calculated as follows:

ΔWC_{it} = change in operating working capital + change in cash and cash equivalents + change in current debt).

The data was obtained from the balance sheets of each firm.

CF_{it} = This represents the net cash flows after interests and taxes for firm i in year t and are computed as follows;

CF_{it} = income before extra-ordinary items + depreciation and amortization + extraordinary items and discontinued operations + deferred taxes + equity in net loss – earnings + other funds from operations + gain (loss) from sales of PPE and other investments).

Data were obtained from the cash flow statements

ΔE_{it} = This represents the net equity issues for firm i in year t and are computed as follows:

ΔE_{it} = common stock sales - stock repurchases. The data was extracted from the financial statements.

3.4 Econometric Approach

The study employed a panel regression model. This is because panel data has the power to incorporate both the cross-sectional and time-series data especially because data may have variations across the periods (Kinyua and Muriu, 2017). This ensures reduced biases through controlling for the omission of variables.

We estimate the models using fixed effect and random effect models after conducting the Hausman specification test. The fixed-effect model allows variations of the intercepts of each firm while at the same time maintaining constant slopes. The random effect model assumes no correlation between firm-specific traits with explanatory variables (Akinlo, 2011).

3.5 Sources of Data

The study mainly used secondary data. These included annual financial statements, annual financial and cash flow reports for all firms listed and trading with NSE for the period between 2011 and 2016. The data was available at both the NSE and Capital Markets Authority (CMA).

The firms were selected based on the following criteria;

- i. They must have traded with the NSE for the period 2011-2016
- ii. They must have all financial and annual reports deemed necessary for this study
- iii. They must not be highly regulated. Hence all banks were excluded

4. Empirical findings and discussions

4.1 Descriptive statistics

This study used panel data across 8 sectors with a total of 37 firms that translated to 222 observations. Table 1 presents the summary statistics of the variables. It is evident that the mean and standard deviations have large values. This can be explained by the different sizes of the firms and sectors. Take for example Safaricom and Kakuzi. While Safaricom gives high dividends to a pool of shareholders, Kakuzi gives fewer to its small number of shareholders. In addition, while some firms borrow heavily, other firms in the sample borrowed little and hence had a smaller portion of financial deficit. Overall, the data did not have major skewness considering that it focused on variables across 8 sectors of firms listed at NSE.

Table 1: Summary Statistics (KES '000,000)

Variable	Mean	N	SD	Min	Max	P50	Skewness	Kurtosis
DIV	0.00103	222	3320	0	30400	59.2	6	47
I	5.935822	222	18	-0.22707	174	0.600407	6	50
ΔWC	-1.175745	222	14.6	-206	27.6	0.03971	-13	176
CF	1.401251	222	6.747949	-60.1	38.1	0.442224	-3	41
ΔD	2.229184	222	24	-66.4	248	-746	7	65
ΔE	0.545297	222	10.9	-137	47.7	220177	-9	118
DEF	2.774481	222	29.4	-142	296	226004	6	58

Source: Own Computation

Table 2 shows that there exists a strong correlation between changes in net debt and financial deficit which is consistent with Shyam-Sunder and Myers (1999), and the pecking order theory. Hence, the more financial deficit a firm has the more it borrows. It is also worth noting the weak correlation, between changes in debt and equity. This confirms the pecking order model which advocates for the use of equity as the last financing option. This confirms the pecking order position that debt financing does not dominate the size of equity financing adopted by a firm (Frank & Vidham, 2003). On the other hand, we observe weak correlations between deficits and factors determining it. For example, there exists a weak and negative correlation between financial cash flows (CF) and changes in debt (Δ D). This is consistent with the POT (Matemilola., Bany-Ariffin, & Carl, 2012), which posits that firms with higher cash flows employ less debt in their capital structure (Ahmad, Kareem, Mautin, & Sakiru, 2015)

Table 2: Correlation Matrix

	DIV	I	Δ WC	CF	Δ D	Δ E	DEF
DIV	1.000						
I	0.0588	1.000					
Δ WC	-0.01	-0.4678	1.000				
CF	0.6393	0.1886	-0.0669	1.000			
Δ D	0.0138	0.4333	0.0396	-0.0107	1.000		
Δ E	0.1117	-0.1844	0.8378	0.0385	0.3187	1.000	
DEF	0.0528	0.2856	0.3437	0.0056	0.9359	0.6322	1.000

Source: Own Computation from the panel data of firms listed at NSE 2011-2016

4.2 Hausman Specification Test

We also tested the most appropriate model using the Hausman test.

The p-value obtained for the POT model was 0.0013 which was less than 0.05 thus the POT model was analyzed using the fixed effect. Table 4, however, shows that the p-value for the debt model was greater than 0.05 and hence the model was estimated using the random effect model.

Table 3: Hausman tests for the POT Model: $\Delta D_{it} = \alpha + \beta_1 DEF_{it} + \varepsilon_{it}$

Coefficients				
	(b)	(B)	(b-B)	sqrt(diag(V_bV_B))
	Fixed	Random	Difference	S.E
DEF	0.749583	0.765046	-0.0154628	0.0047998

Source: Own Computation from the panel data of firms listed at NSE 2011-2016

Test: Ho: difference in coefficients not systematic

Chi2 (1) = (b-B)'[(V_b-V_B)^(-1)](b-B)=10.38

Prob>chi2 =0.0013.

Table 4: Hausman tests for Debt Model

$$\Delta D_{it} = \alpha + b_1 DIV_{it} + b_2 I_{it} + b_3 \Delta W_{it} - b_4 \Delta C_{it} + \varepsilon_{it}$$

Coefficients				
	(b)	(B)	(b-B)	sqrt(diag(V_bV_B))
	Fixed	Random	Difference	S.E
DIV	0.000438	0.000584	-0.0001465	0.0009883
I	0.890237	0.805408	0.0848297	0.1111168
Δ WC	0.509854	0.515396	-0.0055415	0.0534564
CF	-0.54837	-0.55296	0.0045916	0.2164244

Source: Own Computation from the panel data of firms listed at NSE 2011-2016

Test: Ho: difference in coefficients not systematic

chi2 (4) = (b-B)'[(V_b-V_B)^(-1)](b-B)=0.65

Prob>chi2 = 0.9571

4.3 Estimation Results

Table 5 presents the regression results for POT. For POT to hold, β_1 as specified in equation 4 must be equal to one implying a dollar-to-dollar relationship between changes in debt and financial deficit. Hence, according to the POT model, Kenyan firms do indeed have a strong case in following the POT in their financing evidenced by an almost unit POT coefficient (0.75), β_1 (Sunders and Myers, 1999). However, firms have to make difficult financial capital structure decisions and Kenyan firms are no exception. This can be explained by the fact that retained earnings have no financial obligations as compared to debt and equity, which are highly prone to information asymmetry.

Table 5: Regression results of the Pecking Order Theory

	Random Effects Model		Fixed Effects Model	
	ΔD_{it} POT Model	ΔD_{it} Debt Model	ΔD_{it} POT Model	ΔD_{it} Debt Model
DEF_it	0.7650*** (39.4)	-	0.7496*** (37.48)	-
DIV_it	-	0.0006 (1.07)	-	0.000438 (0.39)
I_it	-	0.8054*** (9.08)	-	0.8902*** (6.26)
ΔWC_{it}	-	0.5154*** (4.78)	-	0.5099*** (4.24)
CF_it	-	-0.5530** (-2.03)	-	-0.5484 (-1.57)
Constant	106579.2 (0.19)	-1771604 (-1.17)	149480.5 (0.26)	-2137401 (-1.07)
R^2	-	0.2769	0.884	0.203
Adjusted R^2	-	-	0.861	0.027
AIC	-	-	7672.1	8160.4
BIC	-	-	7678.9	8177.4
Observations	222	222	222	222

T-statistics in parentheses: *p< 0.10, **p< 0.05, ***p< 0.01

Notes: Where DEF_it is Financial Deficit, DIV_it is Cash dividends for firm i in the year t, I_it is a Net investment for firm i in year t, ΔWC_{it} is Change in working capital for firm i in year t, CF_it is Cash flow after interest and taxes for firm i in year t.

The estimation results reveal that investments and change in working capital are statistically significant in explaining the variation of financial debt in Kenya. This is consistent with findings of studies by Atiyet et.al. (2012) in France and Frank and Goyal (2003) in the USA. This implies that higher levels of investments and correspond to more debt in its capital structure.

In Kenya, this could be explained by the fact that financial accessibility in Kenya is highly liberalized and as long as firms have collateral, then they are able to access credit. Large firms have a collateral advantage and borrow more. This makes them follow the pecking order. This is inconsistent with the initial pecking order position that small firms follow pecking order (Shyam-Sunder and Myers (1999). Our study agrees with Ni and

Yu (2008) who found that large firms in China follow the pecking order while small firms do not.

In addition, POT asserts that if a firm is able to control for its internal flow of funds, investing in fixed assets and working capital should commensurately be matched by one to one increase in the amount of debt issued (Frank & Goyal, 2003; Shyam-Sunder and Myers (1999).

The dividend coefficient is not significant which confirms that dividends are sticky and hence when a firm cuts on dividends, such cuts are not used to finance capital expenditure and therefore, firms result in borrowing (Myers, 1984). The negative relationship between debt and cash flows suggests that if a firm has lots of internal cash flows, then it applies less and less debt. This is consistent with the POT position.

5. Conclusions

Using a sample of 37 firms across 8 sectors, this study sought to investigate the applicability of POT among Kenyan firms. Estimation results demonstrate significant support for the applicability of the pecking order theory among Kenyan firms. A random effect regression model on the financial deficit model showed that investments, working capital, and cash flows significantly explain the number of debt firms employ in their capital structure. The more firms invest the more they are likely to borrow and the more cash flows the firms have, the less likely they are to use debt in the financing models. In addition, the fixed-effect model on the POT model revealed that financial deficit prompts firms in Kenya to borrow while factoring in costs involved. Therefore, we conclude that those firms are aware of the costs of information associated with debt and equity. To cut on such costs, they opt for retained earnings first, followed by debt and finally equity as the last resort source.

References

- Abdeljawad, I., Nor, F. M., Ibrahim, I., & Abdul, R. (2013). Dynamic Capital Structure Trade-Off Theory : Evidence from Malaysia. *International Review of Business Research Papers*, 9(6), 102-110
- Abor, J. (2007). Corporate Governance and Financing Decisions of Ghanaian Listed Firms. *Corporate Governance: The International Journal of Business in Society*, 7(1), 83–92.
- Abor, J. (2008). *Determinants of the Capital Structure of Ghanaian Firms* (No. RP_176). Nairobi: African Economic Research Consortium.
- Abor, J., & Biekpe, N. (2005). What Determines The Capital Structure Of Listed Firms In Ghana? *African Finance Journal*, 7(1), 37-48.
- Abor, J., & Biekpe, N. (2006). An Empirical Test of the Agency Problems and Capital Structure of South African Quoted SMEs. *South African Journal of Accounting Research*, 20(1), 51–66.
- Ahmad, M. B., Kareem, S. D., Mautin, O. D., & Sakiru, O. K. (2015). Dynamic Relationship between Debt and Cash flow in Pecking Order Theory: Evidence from Panel GMM. *Journal of Marketing and Consumer Research*, 6(1), 2422-8451.
- Akerlof, G. A. (1970). The Market for “Lemons”: Quality Uncertainty and the Market Mechanism. *The Quarterly Journal of Economics*, 84(3), 488-500.
- Akinlo, O. (2011). Determinants of Capital Structure: Evidence from Nigerian Panel Data. *African Economic and Business Review*, 9(1), 1-16.
- Amidu, M. (2007). Determinants of Capital Structure of Banks in Ghana: An Empirical Approach. *Baltic Journal of Management*, 2(1), 67–79.
- Baker, M., & Wurgler, J. (2002). Market Timing and Capital Structure. *Journal of Finance*, 57(1), 1–32.
- Bany-Ariffin, A. N., & McGowan Jr, C. B. (2012). Trade-off Theory against Pecking Order Theory of Capital Structure in a Nested Model: Panel GMM Evidence from South Africa. *The Global Journal of Finance and Economics*, 9(2), 133-147.
- Booth, L., Aivazian, V., Demircuc-Kunt, A., & Maksimovic, V. (2001). Capital Structures in Developing Countries. *Journal of Finance*, 56(1), 87–130.
- Brealey, R. A. & S. Myers (2003). *Principle of Corporate Finance*. McGraw-Hill/Irwin, New York. 10th Edition
- Brealey, R. A., & Myers, S. C. (2000). *Principles of Corporate Finance*. *Principles of Corporate Finance*. McGraw-Hill/Irwin, New York. 9th Edition.
- Brealey, R.A. and Myers, S.C. (1988). *Principles of Corporate Finance*. 3rd Ed. McGraw-Hill Publishing Co., New York.

- Chen, J. J. (2004). Determinants of Capital Structure of Chinese-Listed Companies. *Journal of Business Research*, 57(12), 1341–1351.
- Chen, L., & Zhao, X. (2004). The modified pecking order theory: new empirical evidence from corporate financing decisions. Unpublished working paper, Michigan State University.
- Chirinko, R.S., Singha, A.R. (2000). Testing Static Trade-Off Against Pecking Order Models Of Capital Structure: A Critical Comment. *Journal of Financial Economics*, 58(3), 417–425.
- Daude, C., & Fratzscher, M. (2008). The Pecking Order of Cross-Border Investment. *Journal of International Economics*, 74(1), 94-119.
- De Jong, A., Kabir, R., and Nguyen, T. T. (2008). Capital Structure around the World: The Roles of Firm-And Country-Specific Determinants. *Journal of Banking & Finance*, 32(9), 1954-1969.
- De Jong, A., Verbeek, M., & Verwijmeren, P. (2010). The Impact of Financing Surpluses and Large Financing Deficits on Tests of the Pecking Order Theory. *Financial Management*, 39(2), 733-756.
- Donaldson, G. (1961), *Company Debt Capacity; A Study of Company Debt Policy and the Determination of Company Debt Capacity*, Harvard Graduate School of Business Administration, Boston.
- Fama, E., French, K., 2002. Testing Trade-off and Pecking Order Predictions about Dividends and Debt. *Review of Financial Studies* 15(1), 1–33.
- Fama, E., Macbeth, J.D., 1973. Risk, Return, and Equilibrium: Empirical Tests. *Journal of Political Economy* 81(3), 607–636.
- Fischer, E.O., Heinkel, R., Zechner, J. (1989). Dynamic Capital Structure Choice: Theory and Tests. *Journal of Finance* 44(1), 19–40.
- Frank, M. Z., & Goyal, V. K. (2003). Testing the Pecking Order Theory of Capital Structure. *Journal of Financial Economics*, 67(2), 217-248.
- Frank, Murray Z. And Goyal, Vidhan K. (2007). Trade-Off and Pecking Order Theories of Debt.
- Franklin, J. Muthusamy. KS (2011). Determinants of Financial Leverage in the Indian Pharmaceutical Industry. *Asian Journal of Management Research*, 380(2), 1.
- Fred, W. J., Thomas, C. E., & Brigham, E. F. (1992). *Managerial Finance. 9th Edition. The Dryden Press Orlando Florida USA.*
- Harris, M., Raviv, A. (1990a). Capital Structure and the Informational Role of Debt. *The Journal of Finance*, 45(2), 321-349.
- Harris, M., Raviv, A. (1991). The Theory of Capital Structure. *Journal of Finance*, 46, 297-355.
- Hovakimian, A. Opler, T. And Titman, S. (2001). The Debt-Equity Choice. *Journal of Financial and Quantitative Analysis*, 36(1), 1-24.
- Jensen, M. C., And Meckling, W. H. (1976). Theory of the Firm: Managerial Behaviour, Agency Costs and Ownership Structure. *Journal of Financial Economics*, 3(4), 305-360.
- Kariuki, S. N., & Kamau, C. G. (2014). Determinants of Corporate Capital Structure among Private Manufacturing Firms in Kenya: A Survey of Food and Beverage Manufacturing Firms. *International Journal of Academic Research in Account*.
- Kraus, A., & Litzenberger, R. H. (1973). A State-Preference Model of Optimal Financial Leverage. *The Journal of Finance*, 28(4), 911-922.
- M., Raviv, A., 1991. The Theory of Capital Structure. *Journal of Finance*, 46(1), 297–356.
- Matemilola, B.T; Bany-Ariffin, A.N (2011). Pecking Order Theory of Capital Structure: Empirical Evidence from Dynamic Panel Data. *International Journal on GSTF Business Review*. 1 (1): 185–189.
- Modigliani, F. And Miller, M. (1958). The Cost of Capital, Corporation Finance and the Theory of Investment. *The American Economic Review*, 48 (3) 261-97.
- Muriu, P. W. (2016). Microfinance Performance. Does Financing Choice Matter. *European Journal of Business and Management*, 8(33), 77-93.
- Murray, F.Z., And Vidham K.G. (2003). Testing Pecking Order Theory of Capital Structure. *Journal of Financial Economics*, 67(2), 217 - 248.
- Myers, S. (1984). The Search for Optional Capital Structure. *Midland Corporate Finance Journal*, 1(1), 6- 16.
- Myers, S. C. (1984). The Capital Structure Puzzle. *The Journal of Finance*, 39(3), 574-592.
- Myers, S., (1977). Determinants of Corporate Borrowing. *Journal of Financial Economics*, 5(2), 147- 176.
- Myers, S.C. (1985). The Capital Structure Puzzle. *Journal of Finance*, 39(3), 575-592.
- Myers, S.C., (2001). Capital Structure. *Journal of Economic Perspectives* 15(2), 81–102.
- Myers, Stewart C.; Majluf, Nicholas S. (1984). Corporate Financing And Investment Decisions When Firms Have Information Those Investors Do Not Have. *Journal of Financial Economics*. 13 (2): 187–221.
- Nairobi Securities Exchange (2016). *NSE Handbook*. Nairobi. NSE.
- Negash, M. (2002). Corporate Tax and Capital Structure: Some Evidence & Implication. *Investment Analysts Journal*, 31(56), 17-27.
- Ngugi, R. W. (2008). Capital Financing Behaviour: Evidence From Firms Listed On The Nairobi Stock Exchange. *The European Journal of Finance*, 14(7), 609-624.

- Ni, J., & Yu, M. (2008). Testing the pecking-order theory: Evidence from Chinese listed companies. *Chinese Economy*, 41(1), 97-113.
- Njoroge, L. N., & Nasieku (2016). Determinants of Capital Structure of Internet Service Providers in Kenya. *The International Journal of Social Sciences and Information Technology*, 2(2)
- Oino, I., & Ukaegbu, B. (2015). The Impact of Profitability on Capital Structure and Speed of Adjustment: An Empirical Examination of Selected Firms in Nigerian Stock Exchange. *Research in International Business and Finance*, 35, 111-121.
- Pandey, M. (2001). *Capital Structure and the Firm Characteristics: Evidence from an Emerging Market*. Available SSRN.
- Ramjee, A., & Gwatidzo, T. (2012). Dynamics in Capital Structure Determinants in South Africa. *Meditari Accountancy Research*, 20(1), 52-67.
- Ramjee, A., & Gwatidzo, T. (2012). Dynamics in Capital Structure Determinants in South Africa. *Meditary Accountancy Research*, 20(1), 52-67.
- Ross, S. A. (1977). The Determination of Financial Structure: The Incentive-Signalling Approach. *The Bell Journal of Economics*, 8(1), 23-40.
- Schaefer, S. M., & Strebulaev, I. A. (2008). Structural Models Of Credit Risk Are Useful: Evidence From Hedge Ratios On Corporate Bonds. *Journal of Financial Economics*, 90(1), 1-19.
- Seifert, B., & Gonenc, H. (2010). Pecking Order Behaviour in Emerging Markets. *Journal of International Financial Management and Accounting*, 21(1), 1-31.
- Sheikh, N. A., & Wang, Z. (2011). Determinants of Capital Structure: An Empirical Study of Firms in the Manufacturing Industry of Pakistan. *Managerial Finance*, 37(2), 117-133.
[Http://Doi.Org/10.1108/03074351111103668](http://doi.org/10.1108/03074351111103668)
- Shyam-Sunder, L., & C. Myers, S. (1999). Testing Static Trade-Off Against Pecking Order Models Of Capital Structure. *Journal of Financial Economics*, 51(2), 219-244.
- Spence, M. (1973). Job Market Signaling. *The Quarterly Journal of Economics*, 87(3), 355-374.
- Stiglitz, J. (1969). A Re-Examination of the Modigliani-Miller Theorem. *The American Economic Review*, 59(2), 784-793.
- Titman, S., & Wessels, R. (1988). The Determinants of Capital Structure Choice. *Journal of Finance*, 43(1), 1-19.
- Weston, J.F, And Copeland T.E, *Management Finance*, Dryden Press, New York, 1986 Working Paper, Indian Institute of Management Ahmedabad.
- Wooldridge, J. M. (2013). *Introductory Econometrics: A Modern Approach*. 5th Edition, Nelson Education, Ltd, Michigan State University Press, Michigan.



Foreign Direct Investment and Economic Growth Of Nigeria (1980-2018)

F. O. Chinyere Osunkwo¹

¹Department of Economics Abia State University Uturu

Abstract

This work examined the impact of foreign direct investment on the economic growth of Nigeria from 1980-2018, secondary data from CBN statistical bulletin of various issues were used. Regression analyses was carried out using the OLS method, it was found out that R² was found to be 81.4%, which shows that the model was highly fitted, while Adjusted R² was 80.9%, which shows that the model was highly correlated, because the 80% change in RGDP, is explained by Foreign direct investment and employment level in the economy during the period under review, the other 19.1% may be explained by other variables not included in the model.

Keywords: Investment, Economic Growth, Inflow

INTRODUCTION

The need for foreign capital to compliment domestic resources in the economic growth process of an economy cannot be over emphasized; it has been welcomed as a catalyst for development. Its significant influence on the provision of new technologies, products, management skills and competitive business environment, and employment generation overtime has been a strong impetus for economic growth. Many countries of the world, especially emerging economies, favor policies that encourage the inflow of foreign direct investment because of its positive impact on provision of funds and expertise that could help smaller companies to expand and increase international sales and transfer of technology, thus forming new varieties of capital input that cannot be achieved through financial investment or trade in goods and services alone. Foreign direct investment is perceived as a way of filling gaps between domestically available supplies of saving (domestic investors), foreign exchange, government revenue, skills and planned level of these resources necessary to achieve economic development. Unfortunately, the experience of Nigeria in the accumulation of foreign direct investment has been unsatisfactory, hence, the accumulation of huge external debt in relation to gross domestic product and faced with serious debt servicing problems in terms of foreign exchange flow and also wallowing in abject poverty. Therefore this work will investigate the impact of FDI and the level of employment generation on real gross domestic product in Nigeria.

LITERATURE REVIEW

In recent years, foreign direct investment has gained renewed importance as a vehicle for transferring resources and technology across national borders. FDI is argued to increase the level of domestic capital formation, and a means of attaining competitive efficiency by creating a meaningful network of global interconnections.

CONCEPTUAL LITERATURE

Foreign direct investment (FDI) is defined as the process where people in one country obtain ownership of assets for the purpose of gaining control over the production, distribution and other activities of a firm in a foreign country (Moosa; 2002).

Anyanwale (2007) defines foreign direct investment as the transfer of resources which is available in developed countries to the less developed countries (LDCs). These developed countries supply scarce capital in form of private foreign investment so as to encourage economic growth in those countries. Foreign direct investment is a tool used by foreign investors to generate foreign exchange through the production of exports in less developed countries.

FDI can take the form of green field investment, mergers and acquisition and joint ventures. Green field investment is the process whereby the investing company establishes new production and distribution facilities in a foreign country because the firm creates new employment opportunities and high value added output, the host country is generally positive to green field investments. An acquisition of, or a merger with an already existing company in a foreign country is another form of FDI. Mergers are cheaper than Green field investments and makes it easier for the investors to get quick market access, but M&As can be harmful to the host country because they may only imply a transfer of ownership that is followed by layoffs and closing of advantageous activities. Moreover, compared to green field investments, the acquisition of companies in the host country is generally not welcomed since the majority of countries prefer to maintain control over domestic companies.

THEORITICAL FRAMEWORK

Foreign direct investment represents a veritable source of foreign exchange and technological transfer, especially to a developing economy like Nigeria. It can be analyzed in terms of inflow of new equity capital (change in foreign share capital), re-invested earning (unremitted profit) (Nwachukwu , 2013).

The Production Life Cycle Theory

This theory states that, foreign direct investment (FDI) exists because of the search for cheaper cost of production. Stating that many manufactured products will be produced first in the countries in which they were researched and developed and these countries are typically industrialized. Over the product life cycle, production will tend to become capital intensive and producers will shift production to foreign locations. So, over time, a product initially introduced and produced in a particular country and exported from that country may end up becoming a product produced elsewhere (in a different country) and then imported back into that country which it was originally introduced and produced in.

THE FATORS INFLUENING THE FLOW OF FDI

1. Market size and growth have proven to be the most prominent determinants of FDI, particularly for those FDI flows that are market seeking. In countries with large markets, the stock of FDI is expected to be large since market size is a measure of market demand in the country.
2. The costs as well as the skills of labor are identified as the major attractions for FDI. The cost of labor is important in location considerations, especially when investment is export oriented (Wheeler and Mody, 1992; Mody and Srinivasan, 1998). Lower labor cost reduces the cost of production, all other factors remaining unchanged. Sometimes the availability of cheap labor justifies this relocation of a part of the

production process in foreign countries. Recent studies however have shown that with FDI moving forward technologically intensive activities, low cost unskilled labor is not in vogue. Rather, there is demand for qualified human capital (Pigato: 2001). Thus, the investing firm is also concerned about the quality of the labor force. It is generally believed that highly educated personnel are able to learn and adopt new technology faster and the cost of retaining is also less. As a result of the need for high quality labor, investors are most likely to target countries where the government maintains a liberal policy on the employment of expatriate staff. This is to enable investors to bring in foreigners to their operation in order to bridge the gap in the skill of local personnel wherever it exists.

3. It is often stated that good infrastructure increases the productivity of investment and therefore stimulate FDI inflows (Asiedu, 2002). A study by Wheeler and Mody (1992) found infrastructure to be very important and dominant for developing countries. In talking about infrastructure, it should be noted that this is not limited to roads alone but includes also, communication system, to facilitate communication between the host and home countries. In addition to physical infrastructure is important for FDI flow.
4. Economic and political stability. Several studies have found FDI in developing countries to be affected negatively by economic and political uncertainty. There is abundant evidence to show the negative relationship between FDI and political and economic instability. In a study on foreign owned firms in Africa, Sachs and Sievers (1998) concludes that the greatest concern is political and macro-economic stability while Lehman (1999) and Jaspersen (2000), found that countries that are less risky attract more FDI. Perception of risk in Africa is still very high and continues to hinder foreign direct investment.
5. Openness of an economy is also known to foster the flows of FDI. The more open an economy is, the more likely it is that it would follow appropriate trade and exchange rate regimes and the more it would attract FDI.
6. The availability of natural resources is a critical factor in attracting FDI. This is particularly so in Africa where a large share of FDI has been in countries with abundant natural resources. In some cases, the abundance of natural resources has been combined with large domestic market. African countries that have been able to attract most FDI have been those with natural and mineral resources as well as large domestic markets. A number of countries including Angola, Nigeria, Cote d'Ivoire, Botswana and Namibia, have been host to FDI because of this advantage.

EMPIRICAL LITERATURE

Agrawal (2015) assessed the relationship between foreign direct investment and economic growth in five economies, namely Brazil, Russia, India, China and South Africa over the period 1989-2012. Co integration and causality analysis were applied. The results indicate that foreign direct investment and economic growth are co integrated at the panel level, indicating the presence of long run equilibrium relationship between them. Results from causality tests indicate that there is long run causality running from foreign direct investment to economic growth in these economies.

Uwubanwen and Ogieudia (2016) examined the effect of foreign direct investment on economic growth in Nigeria using annual time series data covering the period 1979 to 2013. The data were analyzed using Error Correction Model. The results revealed that FDI has both immediate and time lag effect on Nigeria economy in the short run but has a non significant negative effect on the Nigeria economy in the long run.

Pulstova (2016) studied the effects of foreign direct investment and firm export on economic growth in Uzbekistan. The study covered the period 1990-2014, descriptive method was adopted. He found that an increase in FDI may cause firms to increase their export of products.

METHODOLOGY

Secondary data from various CBN statistical bulletins were used, the data were subjected to the least square method of regression analysis.

The hypotheses are stated in null forms.

HO₁ foreign direct investment does not impact any significant impact on Real Gross Domestic Product.

HO₂ Employment level does not exact any significant influence on RGDP.

Model Specification

GDP =f (FDI,EMPL)

Dependent Variable: RGDP

Method: Least Squares

Date: 01/25/20 Time: 13:44

Sample: 1981 2018

Included observations: 38

Variable	Coefficient	Std. Error	t-Statistic	Prob.
FDI	5.208298	0.309644	16.82027	0.0000
EMP	622.2308	49.54075	12.55998	0.0000
C	-3601.827	765.2120	-4.706967	0.0000
R-squared	0.814196	Mean dependent var		4171.145
Adjusted R-squared	0.809035	S.D. dependent var		6348.672
S.E. of regression	2774.338	Akaike info criterion		18.74541
Sum squared resid	2.77E+08	Schwarz criterion		18.83160
Log likelihood	-354.1628	Hannan-Quinn criter.		18.77607
F-statistic	157.7531	Durbin-Watson stat		1.426455
Prob(F-statistic)	0.000000			

From the analysis, $R^2 = 81.4\%$ shows that the model was highly fitted because about 81.4% of the model fell on the regression line while the remaining 8.6% fell below and above the regression line. Adjusted $R^2 = 80.9\%$ shows that the model was highly correlated because 80% change in RGDP was explained by the explanatory variables (FDI and employment) while the remaining 9.1% was due to exogenous variable(s). $t_{b0} = -4.7$, $t_{b1} = 16.82$ and $t_{b2} = 12.55$ shows a positive relationship between RGDP, FDI and EMP. Durbin Watson = 1.426455 shows the presence of positive auto correlation because it is less than 2. Prob(F-statistic) = 0.000000 shows that the overall model was statistically significant at 5% level of significance. Therefore, foreign direct investment has a significant impact on the Nigerian economy for the periods under study.

CONCLUSION

This study attempted to estimate the impact of Foreign Direct Investment on Economic Growth for the period 1980-2018, it was found that FDI has a positive and significant impact on RGDP for the period under review, therefore the following recommendations are made.

RECOMMENDATIONS

- The government should provide an enabling environment to attract foreign direct investment by ensuring peace and safety of lives and property, therefore the killings and spilling of blood in the country should be stopped by reprimanding and bringing to book all the evil perpetrators.
- There should be infrastructural development; to encourage production, this means that good roads should be provided to move products from the place of production to the market. There should also be adequate supply of electricity to aid production process.
- Large market should be created for such products by creating awareness sensitization by the government.

- Government should make concerted efforts to attract foreign investors into Nigeria so as to encourage production and generate employment opportunities, since FDI bears a positive relationship with employment generation.

References

- Agrawal, G.(2015): Foreign Direct Investment and Economic Growth in BRICS Economies: A Panel Data Analysis. *Journal of Economics, Business and Management*, Vol.3, No.4.
- Anyanwale (2007). The impact of foreign direct investment on economic growth of Nigeria. *Journal of Economics and Sustainable development* vol.4,no.2
- Asiedu, E. (2003): “*Policy Reform and Foreign Direct Investment to Africa*” : *Absolute progress but relative decline, Mimeo, department of economics, University of Kansas, United States.*
- Asiedu, E. (2009). Foreign direct investment in Africa; the role of natural resource, market size, government policy, institutional and political instability. Research paper at world institute for development Economics Research (WDDER) conference on sharing global prosperity Helsinki.
- Jaspersen, F.Z., A.H. Aylward and A.D. Knox. (2000), “ The effect of risk on private investment: Africa compared with other areas”.
- Lehmann, A. (1999), “ Country Risks and the Investment Activity of US Multinationals in Developing Countries”, *IMF Working Paper*
- Mody, A. and K. Srinivasan. (1998), “Japanese and United States firms as foreign investors: Do they march to the same tune?” *Canadian Journal of Economics*, 31(4): 778-99.
- Moosa, I.A., (2002), “ Foreign Direct Investment – Theory, Evidence and Practice”. Palgrave, New York. Anthony Rowe Limited.
- Nwachukwu, O.S (2013), External Capital and Economic Development in Nigeria (2000-2012).
- Pigato, W.S (2001) Foreign Direct Investment in emerging economies: A selective survey. *Journal of Development Studies* 40(1).
- Pulstova, M. (2016): Effects of Foreign Direct Investment and Firm Export in Economic Growth: Evidence from Uzbekistan. *European Journal of Business and Management*, Vol.8, No.3.
- Uwubanmwun, A.E. & Ogiemudia, O.A. (2016): Foreign Direct Investment and Economic Growth: Evidence from Nigeria. *International Journal of Business and Social Sciences*, Vol.7, No.3.
- Wheeler, D. and A. Mody (1992), “International investment location decisions: The case of U.S. firms”, *Journal of International Economics* 33, 57-76.

YEAR	FDI	UNEMP	RGDP
1981	0.33	5.2	94.33
1982	0.29	4.3	101.01
1983	0.26	6.4	110.06
1984	0.36	6.2	116.27
1985	0.43	6.1	134.59
1986	0.15	5.3	134.6
1987	2.45	7	193.13
1988	1.72	5.1	263.29
1989	13.88	4.5	382.26
1990	4.69	3.5	472.65
1991	6.92	3.1	545.67
1992	14.46	3.5	875.34
1993	29.66	3.4	1089.68
1994	22.2	3.2	1399.7
1995	75.9	1.9	2907.36
1996	111.3	2.8	4032.3
1997	110.5	3.4	4189.25
1998	80.7	3.5	3989.45
1999	92.8	17.5	4679.21
2000	116	18.1	6713.57
2001	132.4	13.7	6895.2
2002	225.2	12.2	7795.76
2003	258.39	14.8	9913.52
2004	248.2	11.8	11411.07
2005	3432.5	11.9	14610.88
2006	4007.5	12.3	18564.59
2007	4403.8	12.7	20657.32
2008	6041.8	14.7	24296.33
2009	8111.4	19.7	24794.24
2010	9088.8	21.1	54612.26
2011	10958.9	23.9	62980.4
2012	11917.4	26.7	71713.94
2013	12786.7	25.1	80092.56
2014	14706.4	24.3	89043.62
2015	17633	28.7	94144.96
2016	17842.1	28.8	101489.5
2017	17901	29	113719
2018	18123	29.3	127762.6



Community Buyers' Affective Reactions in Social Commerce: Stimuli and Response

Ying-CHieh Yang¹, I-Hua Lin², Hui-Chu Chen³

¹Economics and Management College, Zhaoqing University, China, ying-chieh@hotmail.com

²Department of Hospitality Management, Taiwan Shoufu University, Taiwan, eva176@yahoo.com.tw

³Department of Marketing Management, Transworld University, Taiwan, denise@gm.tw.edu.tw

Correspondence: Hui-Chu Chen, Department of Marketing Management, Transworld University, Taiwan, denise@gm.tw.edu.tw

Abstract

Based on the S-O-R model, the purpose of this study is to probe the roles of community buyers' affective reactions (trust and perceived risk from social commerce) in relationships between five stimuli and consumer engagement in social commerce (CESCI). Integrating prior studies in the social commerce field develops a conceptual model and 12 hypotheses. All data collected from the target population in Taiwan are analyzed through two-step structural equation modeling (SEM) to examine the hypotheses. Of 12 hypotheses, only eight hypotheses are supported and findings confirm the antecedents and outcomes of community buyers' affective reactions in social commerce. Besides the need for empirical confirmation of the hypotheses given, finally, there are several practical implications for social marketers and future research directions for scholars.

Keywords: S-O-R Model, Affective Reactions, Consumer Engagement in Social Commerce Intention

1. Introduction

Social commerce has dramatically impacted the global economy through social media. Not only has social media revolutionized our way of life with chat-based applications (Beig & Khan, 2018; Filo *et al.*, 2015), but has also reconstructed the traditional e-commerce mode (Charoennan & Huang, 2018; Gambetti *et al.*, 2015). Moreover, social media continues to offer opportunities for brands to connect with consumers in new and interesting ways, across a wide variety of platforms. Through social media (e.g. Facebook, Twitter, Instagram, Line, WeChat, and Weibo, etc.), for example, not only can people engage in entertaining activities (e.g. watching videos and playing games), social interactions, and professional networking, but can also engage in a variety of user-centered business activities, so-called social commerce (Yin *et al.*, 2019). Hoffman and Fodor (2010) point out that not only is social commerce a subset of electronic commerce involving a two-way interactive social media, but is also online media supporting social interaction and user contributions to assist online buying and selling of products and services. More succinctly, social commerce is the use of social network(s) in the context of e-commerce transactions. Based

on Statista (2019), as of March 2019, worldwide revenue in the online commerce market amounted to around US two trillion dollars, and is expected to show an annual growth rate (2019–2023) of 8.9%. Statista (2019) further points out online commerce had 56.2% user penetration as of March 2019 and is expected to hit 61.8% by 2023. This is because the power of social networking is such that the number of worldwide users is expected to reach some 3.02 billion monthly active social media users by 2021, around a third of Earth's entire population. Furthermore, social media now has a global penetration rate of 45% (Statista, 2019).

Social media and social commerce are important for both of companies and consumers. Companies adopt social media as a marketing tool to build relationships and communicate with consumers through personal channels of networking and interactivity (Beig & Khan, 2018). Due to enabling companies to reach a large audience at low costs, build brand image and brand awareness, spread social word of mouth (sWOM), as well as improve brand loyalty, social media offers companies great ROI by increasing sales and profits (Hajli, 2018; Hajli *et al.*, 2014). For consumers, for example, social media can provide a channel to consumers for direct communication with firms and other consumers in communities as well as increase the bargaining power of the community and the benefit to lower their transaction costs. Exchanging ideas and information through social media influences on opinions, awareness, and purchase decision-making of consumers (Kim & Ko, 2012).

On average, global internet users spend some 135 minutes per day surfing social networks (Statista, 2019), and social referral to retail ecommerce sites has grown 110% in two years outpacing all other referral channels (eMarketer, 2019). However, it still represents a modest percentage of inbound ecommerce traffic, accounting for only 9.1% in Q1 2019 (eMarketer, 2019). The result indicates that numerous consumers prefer to traditional shopping. This may be because some consumers still consider social media as a platform to interact with other users and engage in entertaining activities. Pavlou and Gefen (2005), moreover, point out the past negative experiences of consumers or negative WOMs reduce consumer engagement in social commerce intention. For example, six common sources of contract violation with online sellers, including fraud, product misrepresentation, contract default, product delivery delay, product guarantees, and payment policy lead consumers to increase the level of risk perception and not trust in community sellers, and then further discourage consumers from engagement in social commerce (Koh *et al.*, 2004).

Taiwan owns the advanced Internet infrastructures, and Taiwanese prevalently adopt social media (e. g. Facebook, YouTube, Line, Messenger, and Instagram, etc.) to interact with each other. Based on SlideShare (2019), there were 19 million active community users in Taiwan in 2018, accounting for 80% of the total number of people in Taiwan. Of these users, 18 million users are used to social media on mobile phones. Not only do these users adopt social media to interact with their friends, family, and colleagues, but also use them to purchase products and services. Moreover, companies and individual sellers adopt the social media to advertise or sell their products and services. In Taiwan, however, a lot of dispute transactions emerge in social commerce (SlideShare, 2019). Therefore, an empirical illustration of this study is focused on the social commerce in Taiwan. Prior studies, additionally, point out many factors influence consumer behavior on social media, but prior studies point out community users place more emphasis on social interactivity (Hajli, 2018; Liang *et al.*, 2011; Park *et al.*, 2014; Shanmugam *et al.*, 2016; Sozer, 2019), information credibility (Hajli, 2018; Hajli *et al.*, 2014; Li & Suh, 2015), security issues (Afshan & Sharif, 2016; Gefen *et al.*, 2003; Pantano & Di Pietro, 2012), social identification (Carvalho & Fernandes, 2018; Pai & Tsai, 2011; Tidwell, 2005; Wu & Li, 2018), and a buyer's perceived past negative experience (PPNE) (Pavlou & Gefen, 2005). The present study, in consequence, considers the five factors (social media interactivity, perceived information credibility, perceived security, social identification, and PPNE) as environmental stimuli influencing trust and risk perception level of buyers in social commerce.

Based on the S-O-R model, empirical illustration of this study is to investigate stimuli and response of community buyers' affective reactions (trust and perceived risk from social commerce) in social commerce. To accomplish these objectives, therefore, the present paper is organized as follows: through literature review and integration in several relevant fields, first of all, the paper derives research hypotheses and develops a conceptual model. Through structural equation modeling (SEM), next, all data collected from the target population in Taiwan are analyzed. Finally, the findings are presented, followed by conclusions and discussions of the findings including several practical implications and future research directions.

2. Literature Review

2.1 The S-O-R Model

In the consumer behavior context, not only does the S-O-R model by Mehrabian and Russell (1974) describe how people react to stimuli in the environment by using three steps: stimulus (S), organism (O), and response (R), but also points out that environmental stimuli (S) lead two contrasting forms of responses (R) in the consumer: approach or avoidance. From psychological aspects, Mehrabian and Russell (1974) illuminate that the two behaviors are generated by the people's internal evaluations (O) of the different cues in the environment. Wu and Li (2018) further expound that the S-O-R model was originally designed for general environmental psychology, but it has been popularly applied and verified to work in marketing and e-commerce literature. Wu and Li (2018), for example, adopt the S-O-R model to verify that six social commerce marketing mix (ACMM) cues (S) of social media impact customer value (O) in social commerce, which then influence customer loyalty (R) in social commerce. Of interest to this study is to develop a framework for explaining the formation of consumer purchase intention in social commerce. Based on the S-O-R model, therefore, the study will examine how five stimuli affect community buyers' affective reactions (O), which in turn influence consumer engagement in social commerce intention (R).

2.2 Trust, Perceived Risk, and Consumer Engagement in Social Commerce Intention

Based on the study by Pavlou and Gefen (2005), consumer engagement in social commerce intention (CESCI) is defined as the degree to which consumers engage in a variety of user-centered and paid business activities through social media. In the commitment-trust literature, not only is trust defined as the trustee will fulfill the trustor's expectations without taking advantage of its vulnerabilities (Gefen *et al.*, 2003), but is also the most important variable in social (Pavlou & Gefen, 2005) and relational exchanges (Hunt & Lambe, 2000). Mayer *et al.* (1995) also consider trust as "the willingness of a person to be vulnerable to the actions of another party based on the expectation that the other will perform a particular action important to the trustor, irrespective of the ability to monitor another party" (p. 312). However, lack of more information about products or services in social commerce will make consumers undergo information asymmetry and further lead to either hinder them from engagement/payment or arouse transaction disputes (Yin *et al.*, 2019). In the study, therefore, trust in social commerce is defined as a buyer's belief that future transactions with sellers in social commerce will occur in a manner consistent with their confident expectations (Pavlou & Gefen, 2005). Not only can trust reduce the uncertainty of transactions and complexity of communication with sellers, but can also further prompt the success of transactions (Shanmugam *et al.*, 2016). Based on the study by Delgado-Ballester *et al.* (2003), trust is able to influence consumer choices and behaviors, because of trust as a psychological state interpreted in terms of perceived probabilities, confidence, or expectations in relation to the other party. In this study, in consequence, trust in the S-O-R model is considered as individual internal evaluations (organism). Findings of the empirical study by Yin *et al.* (2019), for example, point out the higher the level of trust in community of sellers, the stronger consumer purchase intention. The findings are in line with the studies by Pavlou and Gefen (2005) and Rehaman *et al.* (2019). In the study, therefore, the impact of trust on consumer engagement in social commerce intention must be replicated and the hypothesis is framed as follows:

H₁: Trust in SC positively influences CESCI.

In consumer behavior context, perceived risk (PR) refers to a psychological uncertainty occurred during consumption when consumers are unable to make sure the results of products or services that meet their needs (expectations) or the results have adverse or harmful results (Aven & Renn, 2009; Dowling & Staelin, 1994). Featherman and Pavlou (2003) point out suffering a loss in pursuit of a desired outcome will lead consumers to bring about the subjective belief - perceived risk. Unlike face-to-face transactions, for example, social commerce leads consumers to expose individual information, including banking information and contact messages on social media. The private personal information may be illegally used or sold by community sellers (Yin *et al.*, 2019). In online marketplaces, moreover, failure of sellers in social commerce to adequately fulfill their contractual obligation will increase the PR level of consumers (Pavlou & Gefen, 2005). In the study, not only is PR defined

as the buyer's subjective belief that there is a probability of suffering a loss when pursuing transactions with sellers in social commerce (Pavlou & Gefen, 2005), but is also viewed as individual internal evaluations (organism). Jarvenpaa *et al.* (2000) conduct the empirical analysis and find that PR is one important element of buyer-seller relationships. This is because PR is able to reduce the buyer's inclination to engage in online transactions. In the study by Yin *et al.* (2019), however, empirical analysis of data collection from China and France group reveals no impact of PR on purchase intention of users in social commerce. In order to further identify the relationship between PR from SC and CESC, therefore, the hypothesis is proposed as follows:

H₂: PR from SC negatively influences CESC.

2.3 Social Media Interactivity, Trust in SC, and PR from SC

Based on the study by Hajli (2018), social media interactivity (SMI) refers to "social interaction of people in social networking developed by Web 2.0 technologies such as online communities which empower people to have some interaction with their peers" (p.800). Alba *et al.* (1997) further point out that interactivity is decomposed into two dimensions, including reciprocity and control. Not only does reciprocity means interaction should mutual and the information which is exchanged should be related, but also has no delay in communicating back to the other person or entity. Control means that an interactive website should empower a user to have some control over the information (Alba *et al.*, 1997). In the study, SMI is described as a digital platform where the like-minded users interact with each other through discussions, suggestions on specific products/services, or sellers and express their views on specific issues (Muntinga *et al.*, 2011).

Through information exchange and discussions, SMI can lead users to accept the views of other community members and further enhance the degree of intimacy between users in online communities (Park *et al.*, 2014). Researchers also reveal that the higher the degree of intimacy, the stronger the emotional support of consumers from online communities (Liang *et al.*, 2011). Findings of the empirical studies point out not only can emotional support help build trust in close friends in the community (Shanmugam *et al.*, 2016), but can also further improve consumer purchase decision-making (Ng, 2013). Chiu *et al.* (2018), however, point out trust promoted by SMI in the community unnecessarily implies a sense of trust in SC. In order to bridge the gap, therefore, the hypothesis is proposed as followed:

H_{3a}: SMI has a positive impact on trust in SC.

Due to uncertainty avoidance, and unpredictable outcomes of social commerce, however, risk perception of consumers increases, followed by leading consumers to pay more attention to searching information in order to clarify the consequences and consequently reducing the PR level (Kellerman & Reynolds, 1990). As mentioned above, social interaction can promote communication among community members and further lead to a reduction in risk perception level. Through social interaction, for example, community users provide their feedback and share their opinions with other users to obtain required information and further diminish the uncertainties and PR level about purchase decisions (Sozer, 2019). In the social commerce context, therefore, SMI may be viewed as an antecedent of PR from SC, and then the hypothesis is proposed as follows:

H_{3b}: SMI has a negative impact on PR from SC.

2.4 Perceived Information Credibility, Trust in SC, and PR from SC

In the information system literature, due to the message receivers' perception on the credibility of a message, perceived information credibility (PIC) is considered as a crucial driver of receiver information adoption (Cheung & Thadani, 2012; Li & Suh, 2015). In social networking context, not only is PIC defined as the extent to which individuals perceive information to be believable, but is also a strong predictor of information readers' future actions, such as recommendation or willingness to adopt viewpoint of the received information (Li & Suh, 2015). However, the lack of credibility in information will lead consumers to lower confidence in and increase PR level from social commerce of sellers (Hajli, 2018; Pavlou & Gefen, 2005). That is, inaccurate information provided by

sellers can decrease trust in social commerce of sellers, increase PR level, and then further lose interest in social commerce. On the other hand, information produced through social media is reflecting a mechanism to provide credibility of the information, then further establish trust and reduce risk perception. The influence of this information is greater than offered by companies or individual sellers (Hajli *et al.*, 2014). In social commerce, for example, community buyers are more likely to observe other community members' opinions, rating valance, and rational text review towards products, services, and even sellers in order to reduce uncertainty risk and unpredictable outcomes of transactions. This is because others' opinions represent indirect experience on many sensory aspects (Hajli *et al.*, 2014). Moreover, findings of empirical studies reveal the positive effect of information credibility on consumers' decision-making (Awad & Ragowsky, 2008) and purchase intention (Prendergast *et al.*, 2010). This may be because not only can the credibility of information strengthen trust among community members, but can also reduce PR from a social media platform (Li & Suh, 2015). Due to involvement in transactions in social commerce, on the other hand, whether PIC increase trust in SC and diminish PR from SC is uncertain. In the social commerce context, therefore, two hypotheses are proposed as follows:

H_{4a}: PIC has a positive impact on trust in SC.

H_{4b}: PIC has a negative impact on PR from SC.

2.5 Perceived Security, Trust in SC, and PR from SC

In the online marketplace, perceived security (PS) is one of the major concerns of social commerce because a lack of transaction safety is one of the main reasons why consumers connect online but do not purchase goods over the internet (Gefen *et al.*, 2003). An example of Facebook data scandal is that the US Federal Trade Commission (FTC) has been investigating allegations Facebook inappropriately shared information belonging to 87 million users with the now-defunct British political consulting firm Cambridge Analytica. The FTC in 2019 has approved a roughly \$5bn (£4bn) settlement with Facebook over its investigation into the social media company's handling of user data (INDEPENDENT, 2019). Unlike traditional transactions, consumers have to reveal their sensitive information (e.g. phone number, address, and credit card number, etc.) through non-face-to-face transaction when consumers buy products or services on social media platforms. Not only is PS considered as the extent to which one believes that the web is secure to transmit sensitive information (Wang *et al.*, 2003), but is also defined as a "circumstance, condition, or event with the potential to cause economic hardship to data or network resources in the form of destruction, disclosure, modification of data, denial of services, and/or fraud, waste, and abuse" (Kalakota & Whinston, 1996, p123). In this study, PS in social commerce refers to the extent to which consumers believe that using social media will be secure (Pantano & Di Pietro, 2012). Security concerns in social commerce occur when consumers have no experience with a digital platform or have undergone negative online transactions. Afshan and Sharif (2016) highlight that security mechanisms provided by social media can lead consumers to believe in the e-retailer and feel confident that their subjective risk has been minimized. Moreover, PS has the higher ability to predict and explain the success of not only internet banking but also of any e-commerce-related website. That is, the higher perceived security, the more consumers feel comfortable and the lower the level of consumer fear, and then further the stronger consumer purchase intention in social commerce. In social commerce context, therefore, two hypotheses are proposed as follows:

H_{5a}: PS has a positive impact on trust in SC.

H_{5b}: PS has a negative impact on PR from SC.

2.6 Social Identification, Trust in SC, and Perceived Risk from SC

Based on social identity theory, social identification (SI) is a person's sense of who they are based on their group membership(s). The groups (e.g. social class, family, football team etc.) which people belonged to were an important source of pride and self-esteem (Tajfel, 1979). Not only does SI refer to the degree to which a community member perceived as belonging to a community, but also in turn occurs in categorization, group polarization, and self-stereotyping (Turner, 1975). Social categorization refers to perception, definition, and recognition of both self

and others as members of distinct social groups (Wu & Li, 2018), while group polarization is “the common, typical, or representative attributes, behavior, and norms that defined and distinguish one group from others are ascertained” (Mackie, 1986, p.720). Finally, self-stereotyping occurs when the perceived characteristics and norms of the group are attributed to the self (Turner, 1975). The study by Tidwell (2005), individuals with higher SI will be more likely to exchange their ideas or benefits on social media and thereby foster cohesiveness among community members. This is because individuals identify with a community, followed by emotionally attaching to a community and then further make value-added contributions to a community where they belong (Tidwell, 2005). The cohesiveness will lead individuals to rely on community members and then further are more likely inclined to support the products, services, or sellers endorsed or recommended by other members while they identify with and become emotionally attached to the community associated with a particular online shopping context (Pai & Tsai, 2011). Findings of the study by Carvalho and Fernandes (2018) indicate moderating effects of identification with social media on the relationship between trust and customer brand engagement. However, the authors have no further explanation for direct effects of SI on trust in social commerce. On the other hand, the cohesiveness increases the frequency of social interaction and enhance the degree of intimacy among community members, followed by trust building among community users as well as reduction in a decrease in the level of risk perception and anxiety from communities. On the other hand, an increase in confidence of consumers among community users and a reduction in PR from communities insufficiently strengthen trust in and diminish PR from social commerce (Chiu *et al.*, 2018). In order to bridge the gap, therefore, two hypotheses are proposed as follows:

H_{6a}: SI has a positive impact on trust in SC.

H_{6b}: SI has a negative impact on PR from SC.

2.7 A Buyer's Perceived Past Negative Experience, Trust in SC, and PR from SC

Research reveals that Psychological contract violation (PCV) with the virtual community of sellers is significantly evoked by the buyer's perceived past negative experience (PPNE) (Pavlou & Gefen, 2005). This may be because if a buyer previously encountered problematic transactions with individual sellers in social commerce, then this experience more likely results in PCV with the community of individual sellers, followed by probably discouraging buyers from engagement in social commerce again. Pavlou and Gefen (2005) point out the buyer will probably form a general opinion about the seller community through his or her perceived past negative experience with a small number of sellers. Six main problematic transacting sources in social commerce, including fraud, product misrepresentation, contract default, product delivery delay, product guarantees, and payment policy, lead to PCV with the virtual community of sellers (Koh *et al.*, 2004). Not only can PVC ruin a buyer's beliefs that sellers will behave in a manner consistent with their confident expectations, followed by eroding the initial trust that buyers have in the community of sellers (Goles *et al.*, 2009; Malhotra *et al.*, 2017), but can also create a sense of betrayal and unfair treatment, followed by causing buyers to pay more attention to potential adverse outcomes related to new and potentially opportunistic sellers and increase buyers' perceived risk from transactions with the community of sellers (Hill *et al.*, 2009; Pavlou & Gefen, 2005).

In this study, a buyer's perceived past negative experience is defined as the level to which the buyer perceive negatively encounters with particular sellers in social commerce. The level of a buyer's perceived past negative experience, in consequence, basically depends on the perception of a buyer. The present study, as a result, presumes that a buyer's perceived past negative experience has the negative impact on trust in SC and the positive impact on PR from SC. This might be because the higher the level of a buyer's perceived past negative experience, the stronger PCV with the virtual community of sellers, followed by the weaker trust in SC and the stronger PR from SC (Chopdar & Sivakumar, 2018; Malhotra *et al.*, 2017; Pavlou & Gefen, 2005). In the social commerce context, therefore, the following two hypotheses are proposed:

H_{7a}: PPNE negatively influences trust in SC.

H_{7b}: PPNE positively influences PR from SC.

2.8 Research Model

Based on the S-O-R model, the conceptual model in this study will examine antecedents and outcomes of community buyers' affective reactions (trust and PR in SC) in CESC (see Figure 1).

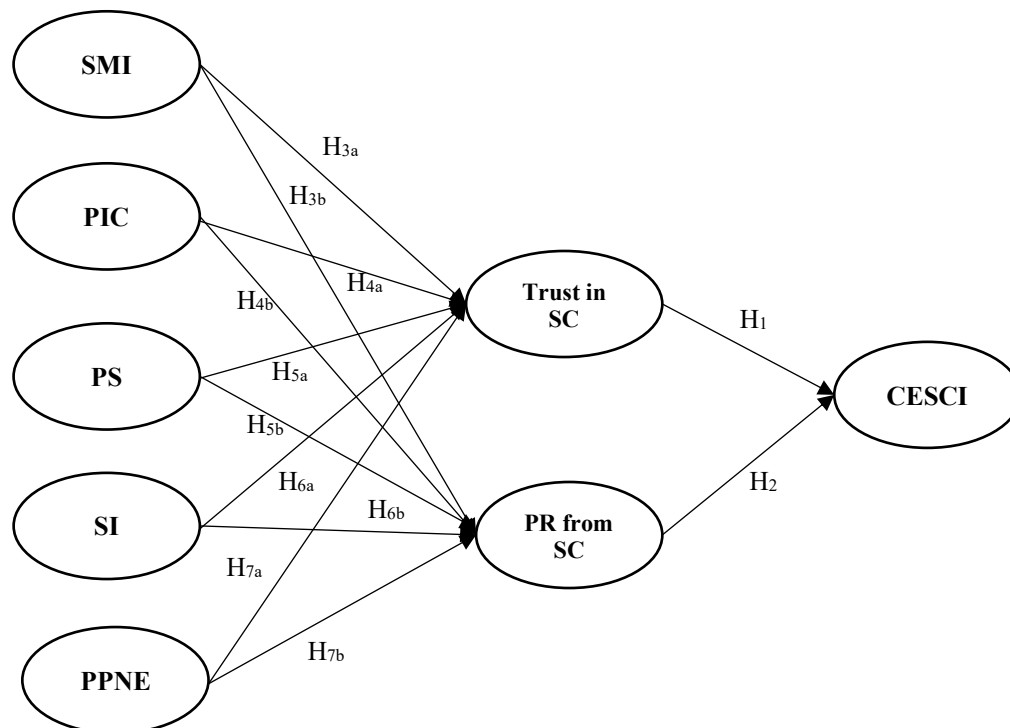

Figure 1. Conceptual Model.

3. Research Method

3.1 The Questionnaire Design and Data Collection

A personally administered questionnaire is used to collect the data from the target population. A total of 35 items made-up the questionnaire which contained nine parts: demographic information, SMI, PIC, SI, PS, trust in SC, PR from SC, a buyer's perceived past negative experience (PPNE), and CESC. Personal characteristics (6 items) include gender, age, education, occupation, month income, and marital status. An instrument measuring eight constructs are designed according to previous studies. For example, four items measuring SMI are adapted from Hajli (2018). Four items measuring PIC are adapted from Li and Suh (2015). SI (4 items) and PS (4 items) are measured using the scales developed by Wu and Li (2018), and Wang *et al.* (2003), respectively. Trust in SC (4 items), PR from SC (3 items), and a buyer's PPNE (3 items) are measured using the scales adapted from Pavlou and Gefen (2005). Three items, finally, is adapted from Rehman *et al.* (2019) to measure CESC.

Lissitz and Green (1975) point out Likert-type scales are easily completed by respondents and provide reliability. Therefore, all items in this study are measured on a five-point Likert-scale (1 = strongly disagree, 5 = strongly agree). All items originally in English are translated into Chinese and back-translated into English to ensure equivalent meaning (Brislin, 1980). The questionnaire is also pre-tested using undergraduate business students with social commerce experiences. The feedback from the pre-test is used to improve the readability and the questionnaire. Based on the recommendation of Hair *et al.* (2006), moreover, a reliable sample size is a minimum of five respondents per survey item. The questionnaire in this study had 35 items, which means the minimum number of respondents for factor analysis for this study should be 200. A total of 349 respondents complete the questionnaires.

Due to the high rate of adopting social media in Taiwan, 1,000 questionnaires are randomly distributed at three department stores, two shopping malls, and two hyper markets in two special municipalities, respectively, including Tainan and Taichung in Taiwan. The total population of these two municipalities accounts for about 20% of the population of Taiwan (Dept. of Household Registration, 2018). The questionnaires are conducted face-to-face during over a two-month period from October 1, 2019 to November 30, 2019. At the end of the data collection process, of 392 completed participants, the final number of usable questionnaires is 349, for a response rate of 34.90%. Of the 349 participants, 185 (53.0%) are female and 164 (47.0%) are male. The average age and month income of the 349 participants is 29.5 years and about US\$1152.5 based on the US\$/NT\$ exchange rate of NT\$30.37. All data collected from the target population are analyzed through two-step structural equation modeling (SEM) a measurement model and a structural model to establish validity of the instrument and examine the path analysis.

3.2 Analysis of Common Method Variance, Reliability, and Validity

In order to avoid the common method variance (CMV) problem, the study adopts the Harman's one-factor test and the confirmatory factor analysis (CFA) of the single factor to test obscuring the meaning of the measurement items and random ordering the measurement items. Podsakoff and Organ (1986) point out the Harman's one-factor test is viewed as a post hoc remedy for CMV to confirm that no such problem exists. Two factors are extracted from the measurement items. The explanatory power of the first factor is 43.08%, which is less than 50 % and indicates no significant problem of CMV in the sample data. Moreover, the confirmatory factor analysis (CFA) of the single factor shows that the factor loadings of all 29 measurement items are not all significant (above the criteria of 0.5). Next, because GFI, AGFI, and NFI are sensitive to the sample size, the study only presents the results, including $\chi^2 / df = 10.816$, TLI = .452, CFI = .491, PNFI = .435, and RMSEA = .168. In contrary, the goodness-of-fit of the proposed model (including $\chi^2 / df = 2.300$; TLI = .937; CFI = .946; PNFI = .783; and RMSEA = .061) is better than that of the single factor. Therefore, the findings indicate no significant CMV problem (Hooper *et al.*, 2008).

Through confirmatory factor analysis (CFA), measurement validity is first evaluated, and the result shows an acceptable model fit to the data: $\chi^2 / df = 2.124$ ($p < .001$); RMSEA = .057 ($< .06$); RMR = .049 ($< .06$); GFI = .901 ($> .90$); AGFI = .890; CFI = .946 ($> .90$); NFI = .904 ($> .90$); TLI = .947 ($> .90$); IFI = .937 ($> .90$) (Hair *et al.*, 2006). Convergent validity assesses the extent to which items designed to measure the same construct are related, while discriminate validity assesses the degree to which items designed to measure different constructs are related (Hair *et al.*, 2006). It is found that standardized factor loadings of all items measuring the same constructs are over .63 and significantly related ($p < .001$) (see Table 1). As shown in Table 1, Cronbach alpha and the composite reliability (CR) for all constructs are larger than 0.7, which the internal consistency and stability of the instrument is acceptable (Nunnally, 1978). Moreover, the average variance extracted (AVE) for all reach constructs of this study exceeds .50 and 0.80. Therefore, convergent validity is established (Fornell & Larcker, 1981). Fornell and Larcker (1981), finally, point out discriminant validity is tested by comparing the shared variance among indicators of a construct with the variance shared between constructs. The test for discriminant validity is met when the square root of AVE for the construct is greater than its correlations with other constructs. As a result, absolute correlation values of all items measuring different constructs are significantly low and range from .00 to .63 (see Table 2). Therefore, discriminant validity is established.

Table 1. Standardized loadings and reliabilities

Construct	Indicators	Standardized loadings	AVE	CR	Cronbach's α
SMI	SMI1	0.634***	0.527	0.815	0.810
	SMI2	0.823***			
	SMI3	0.753***			
	SMI4	0.679***			
PIC	PIC1	0.887***	0.848	0.957	0.957
	PIC2	0.923***			
	PIC3	0.939***			

	PIC4	0.934***			
SI	SI1	0.799***	0.626	0.870	0.868
	SI2	0.869***			
	SI3	0.736***			
	SI4	0.754***			
PS	PS1	0.831***	0.598	0.855	0.853
	PS2	0.746***			
	PS3	0.837***			
	PS4	0.667***			
Trust	Trust1	0.766***	0.714	0.908	0.910
	Trust2	0.757***			
	Trust3	0.910***			
	Trust4	0.931***			
PR	PR1	0.921***	0.798	0.922	0.921
	PR2	0.909***			
	PR3	0.848***			
PPNE	PPNE1	0.646***	0.623	0.830	0.823
	PPNE2	0.902***			
	PPNE3	0.799***			
CSCI	CSCI1	0.810***	0.680	0.864	0.862
	CSCI2	0.793***			
	CSCI3	0.869***			

Note: Goodness-of-fit indices ($N = 349$); $\chi^2 (348) = 739.165$ ($p < 0.001$); RMSEA = 0.057; RMR = 0.049; GFI = 0.901; AGFI = 0.890; CFI = 0.946; NFI = 0.904; TLI = 0.947; IFI = 0.937.

SMI = social media interactivity; PIC = perceived information credibility; SI = social identification; PS = perceived security; PR = perceived risk; PPNE = a buyer's perceived past negative experience; CSCI = consumer social commerce intention.

Table 2. Correlation among constructs and the square root of the AVE

	SMI	PIC	SI	PS	Trust	PR	PPNE	CSCI
SMI	<i>0.726</i>							
PIC	0.458	<i>0.921</i>						
SI	0.383	0.513	<i>0.791</i>					
PS	0.371	0.622	0.561	<i>0.773</i>				
Trust	0.357	0.627	0.490	0.614	<i>0.845</i>			
PR	-0.090	-0.035	-0.053	-0.143	-0.014	<i>0.893</i>		
PPNE	-0.068	-0.001	-0.014	-0.098	-0.130	0.225	<i>0.789</i>	
CSCI	0.490	0.458	0.415	0.471	0.454	-0.125	-0.034	<i>0.825</i>

Note: Diagonal elements (in italics and bold) are the square root values of AVE.

4. Results

The conceptual model is assessed by examining the path coefficients (the β weight values in Table 3). Through software AMOS 21, findings indicate indices: $\chi^2 / df = 2.187$ ($p < .001$); RMSEA = .058 ($< .06$); RMR = .073 ($> .06$); GFI = .874 ($< .90$); AGFI = .843 ($< .90$); CFI = .943 ($> .90$); NFI = .90 ($> .90$); TLI = .934 ($> .90$); IFI = .943 ($> .90$). Due to being sensitive to the sample size, GIF, AGIF, and RMR are under the acceptable indices. However, other indices are up to the acceptable indices, overall, the structural model fit is acceptable (Hair *et al.*, 2006). As shown in Table 3, all path coefficients and t-statistics for hypothesized relationships are calculated through Maximum Likelihood in AMOS, and these findings indicate that the structural model has a good fit (Bagozzi & Yi, 1988).

As shown in Table 3., findings indicate H_1 and H_2 are supported because trust in SC has a significant positive impact on purchase intention and the weight value ($\beta = 0.521, p < .001$), as well as PR from SC has a significant negative impact on purchase intention and the weight value ($\beta = -0.155, p < .01$). Not only does PS positively influence trust in SC with the weight value ($\beta = 0.358, p < .0001$), but also negatively impacts PR from SC with the weight value ($\beta = -0.262, p < .01$). Therefore, H_{5a} and H_{5b} are supported. On one hand SMI has a negative impact on PR from SC and the weight value ($\beta = -0.167, p < .05$), on the other hand SMI has no impact on trust in SC. As a result, H_{3b} is supported, but H_{3a} is not supported. The same procedure is conducted to test the effect of PIC, SI, and PPNE on trust in SC and PR from SC. It is found that PIC has no impact on PR from SC (thus, H_{4b} is not supported), but PIC has a positive impact on trust in SC and the weight value ($\beta = 0.305, p < .001$) (thus, H_{4a} is supported). Findings, moreover, reveal no effect of SI on trust in SC and PR from SC (thus, H_{6a} and H_{6b} are not supported). On the other hand, not only does PPNE have the negative on trust in SC, but also positively influences PR from SC. Therefore, findings support H_{7a} and H_{7b} .

Table 3. Path coefficients and t value

Path	Standardized coefficients	t value
SMI \rightarrow Trust	0.074	1.354
SMI \rightarrow PR	-0.167*	-2.276
PIC \rightarrow Trust	0.305***	4.575
PIC \rightarrow PR	-0.047	-0.546
PS \rightarrow Trust	0.358***	4.567
PS \rightarrow PR	-0.262**	-2.654
SI \rightarrow Trust	0.092	1.490
SI \rightarrow PR	-0.028	-0.347
PPNE \rightarrow Trust	-0.122**	-2.713
PPNE \rightarrow PR	0.188**	3.147
Trust \rightarrow CESCO	0.521***	8.457
PR \rightarrow CESCO	-0.155**	-2.920
Model fit statistics (N = 349)		
$\chi^2(df)$	765.482(350)	
χ^2/df	2.187	
GFI	0.874	
AGFI	0.843	
RMSEA	0.058	
RMR	0.073	
CFI	0.943	
NFI	0.900	
TLI	0.934	
IFI	0.943	

Note: * $p < 0.05$; ** $p < 0.01$; *** $p < 0.001$; SMI = social media interactivity; PIC = perceived information credibility; SI = social identification; PS = perceived security; PR = perceived risk; CESCO = consumer social commerce intention; PPNE = a buyer's perceived past negative experience.

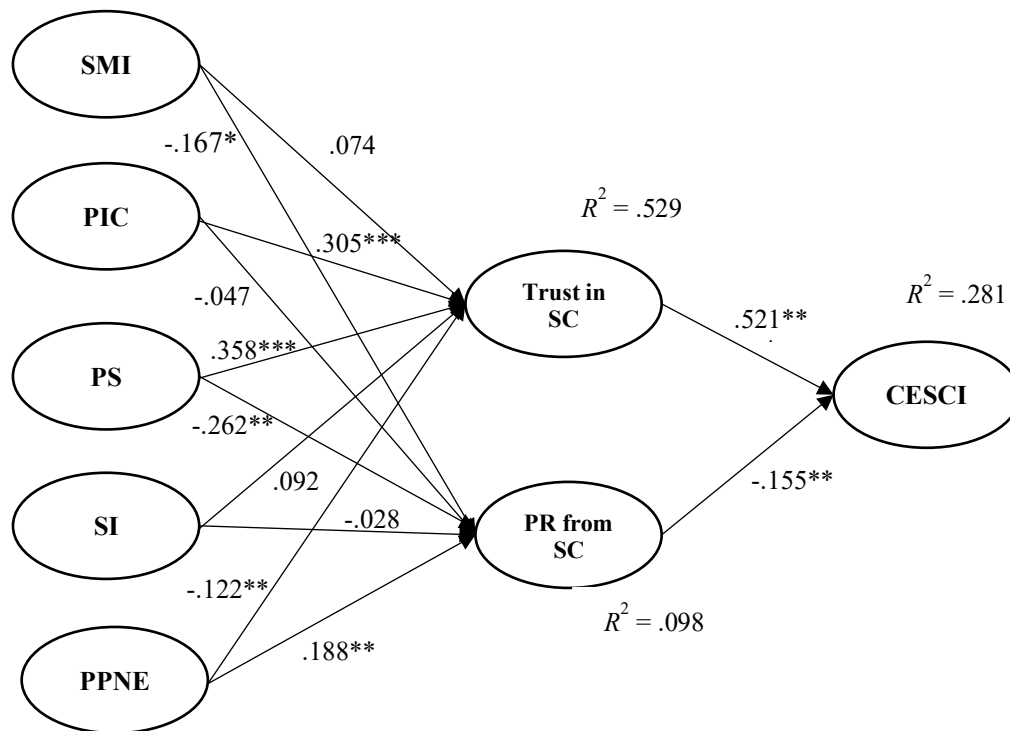

Figure 2. The Results of Conceptual Model Testing

5. Conclusions and Discussion

Based on the empirical findings in Figure 2., several conclusions can be drawn. First of all, supporting H_1 and H_2 leads to the fact that the higher trust in SC or the lower PR from SC, the stronger CЕСCI. The findings are in line with prior studies by Jarvenpaa *et al.* (2000), Pavlous & Gefen (2005), and Rehaman *et al.* (2019). Second, SMI is found to have the negative impact on PR from SC. That is, the more frequent social interaction, the lower PR from SC. This is because the feedback and opinions from the community members can diminish users' uncertainties and risk perception level about information evaluation purchase decision (Sozer, 2019). On the other hand, SMI has no impact on trust in SC because trust by social interaction in the community insufficiently implies a sense of trust in SC (Chiu *et al.*, 2018). Third, it is found that PIC has the positive impact on trust in SC. The more accurate and the more credible information produced through social media, the higher trust in SC (Hajli *et al.*, 2014). However, findings indicate PIC insignificantly influences PR from SC. This is probably because transactions between buyers and sellers in social commerce lead to an increase in risk perception of buyers (Yin *et al.*, 2019).

Findings, fourth, indicate the effects of PS on trust in SC and PR from SC. That is, the higher PS in SC, the more comfortable consumers feel and the lower the level of consumer fear, and then further the stronger consumer purchase intention in social commerce (Afshan & Sharif, 2016). Fifth, the study indicates that SI has no impact on trust in SC and PR from SC. The findings are inconsistent with the studies by Pai and Tsai (2011), and Tidwell (2005). Chiu *et al.* (2018) point out this may be because SI can lead to build trust among community members as well as reduce the level of risk perception in communities, but an increase in confidence of users among community members and a reduction in PR in communities unnecessarily improve trust in SC and reduce PR from SC. H_{7a} and H_{7b} supported, finally, demonstrates that when community buyers have higher perception of negative experiences in social commerce, the level of their trust in SC is mitigated, but their risk perception is strengthened. For example, if buyers previously suffering negative experiences with community sellers have hostile opinion about the performance of these sellers, then these buyers are more likely to perceive PCV with other sellers on social media and more reluctant to engage in social commerce in the future (Pavlou & Gefen, 2005).

6. Contributions and Implications

6.1 Theoretical Contributions

In terms of theory building, this study develops a conceptual model to examine the roles of community buyers' affective reactions in social commerce. In consequence, findings of the empirical research have several theoretical constitutes. Based on the PCV theory, first of all, this study is one of the first studies identifying a buyer's perceived past negative experience as an antecedent of community buyers' affective reactions in SC. When previously encountering problematic transactions with community sellers, buyers are more likely to perceive PCV with community sellers and followed by reduction in trust in these sellers, increase in PR from SC, and more reluctance to purchase their products or services in the future (Pavlou & Gefen, 2005).

In the social commerce context, second, parts of the four community stimuli (SMI, PIC, PS, and SI) about social media completely influence trust or PR in social commerce. Prior studies, for example, indicate SMI and SI significantly influence trust among community members (Carvalho & Fernandes, 2018; Liang *et al.*, 2011; Park *et al.*, 2014; Shanmugam *et al.*, 2016). The study, however, points out trust promoted by SMI or SI in the community is unable to completely transfer to a sense of trust in social commerce. In social commerce, this is because SMI and SI insufficiently provide a mechanism (e.g. mutual understanding, reciprocal favor, and relationship harmony, etc.) between buyers and sellers (Chiu *et al.*, 2018). For example, relationships among community users possessing one of the three mechanisms, including mutual understanding, reciprocal favor, and relationship harmony lead to buyers' trust in community sellers. Empirical findings of the study also demonstrate that PR reduced by PIC or SI about a social media platform unnecessarily implies a reduction in PR from SC. This may be because transactions between buyers and sellers in social commerce lead to higher risk perception of buyers (Yin *et al.*, 2019). Finally, PS are identified as an important antecedent of trust and PR from social commerce. It is recommended that the more perfect security mechanisms in SC, the stronger trust in SC and the lower PR from SC.

6.2 Practical Implications

The findings of this study lead to several practical implications for social sellers. Empirical findings, first of all, indicate that trust and PR in SC are two drivers of CESC. Therefore, it is strongly recommended that community sellers have to improve trust and decrease risk perception of buyers in SC. In order to avoid PCV occurrence, for example, community sellers have to comply with initial contracts between buyers and them. In case of emergence of transaction dispute, community sellers have to redeem the problematic transactions by providing service recovery and preferential strategies. Of five stimuli, second, PS significantly influences trust and PR from SC simultaneously. This implies buyers take their personal information and security mechanisms by social media seriously when engaging in SC. In order to prevent buyers' personal information, therefore, social media owners have to enact strict regulations and build perfect security mechanisms, and then further make sure buyers and sellers comply with these regulations. In order to minimize the risk perception and enhance trust of buyers, moreover, not only do community sellers have to comply with the regulations of the contracts between buyers and them, but also protect personal information of buyers from disclosure, modification, and abuse of data (Kalakota & Whinston, 1996).

Third, the negative impact of SMI on PR from SC implies that an increase in social interaction among community members can lessen the PR level of buyers in SC. As a result, it is recommended that social sellers should encourage users previously buying products or services to share their feedback and experiences with others. Moreover, social sellers timely provide community members' accurate opinions, rating valance, and rational text review towards products/service and sellers so as to lower risk perception of buyers. Findings indicate no impact of SMI on trust in SC, but an increase in social interaction among community members is able to build trust in the community, and then in the long term the sense of trust among community members can transfer to trust in SC. Due to PIC as a crucial antecedent of trust in SC, fourth, it is recommended that accurate and credible information provided by sellers can increase trust in SC. PR from SC is insignificantly influenced by PIC, but information asymmetry and questionable formation about products/services are able to lead to a reduction in buyers' risk level

(Hajli, 2018; Pavlou & Gefen, 2005). Therefore, social sellers still have to reduce information asymmetry as well as provide credible messages and other community members' feedback, experiences, and opinions towards products/services. Finally, a buyer's perceived past negative experience incurs PCV of individuals and further leads to the negative and positive effects on trust in SC and PR from SC, respectively. In consequence, community sellers have to understand about main problematic transacting sources arousing PCV and then make more promises and provide well recovery to consumers after failure in transactions. Moreover, it is recommended that customers make a greater request for promises of sellers on a social media platform in order to protect themselves from unpredictable outcomes of social commerce.

7. Limitations and Future Research

This study provides some insight into the roles of community buyers' affective reactions (trust and PR from SC) in CESC, but it has several limitations for future research directions. First of all, the results are limited due to the evidence indicating that parts of five stimuli have impacts on trust and PR in SC. This may be because there are existences of mediators between these stimuli (e.g. SMI, PIC, and SI) and affective reactions (trust and PR from SC) (Chiu *et al.*, 2018). Consequently, it is recommended that future research should explore mediating variables between stimuli and affective reactions (trust and PR from SC). Second, sample size is always an issue in an empirical study. Data collection from 349 usable social participants sufficiently establish model validation in this study, but findings might be unable to generalize to the entire SC population. As a result, it is recommended that future studies are needed to examine and validate the generalizability of the findings to more social user data. With the globalization, finally, multicultural integration and collision might be able to influence user behavior in social commerce. Therefore, other kind of user behavior in multicultural context is still a topic worth exploring.

References

- Afshan, S., & Sharif, A. (2016). Acceptance of mobile banking framework in Pakistan. *Telematics and Informatics*, 2(1), 35-50.
- Alba, J., Lynch, J., Weitz, B., Janiszewski, C., Lutz, R., Sawyer, A., & Wood, S. (1997). Interactive home shopping: consumer, retailer, and manufacturer incentives to participate in electronic marketplaces. *The Journal of Marketing*, 61(3), 38-53.
- Aven, T., & Renn, O. (2009). On risk defined as an event where the outcome is uncertain. *Journal of Risk Research*, 12, 1-11.
- Awad, N. F., & Ragowsky, A. (2008). Establishing trust in electronic commerce through online word of mouth: an examination across genders. *Journal of Management Information Systems*, 24(4), 101-121.
- Bagozzi, R. P., & Yi, Y. (1988). On the evaluation of structural equation models. *Journal of the Academy Marketing Science*, 16, 74-94.
- Beig, F. A., & Khan, M. F. (2018). Impact of social media marketing on brand experience: a study of select apparel brands on Facebook. *Vision*, 22(3), 264-275.
- Brislin, R. W. (1980). Translation and content analysis of oral and written material. In H. C. Triandis, & J. W. Berry (Eds.), *Handbook of cross-cultural psychology* (2nd Eds) (pp. 389-444). Boston, MA: Allyn and Bacon.
- Carvalho, A., & Fernandes, T. (2018). Understanding customer brand engagement with virtual social communities: a comprehensive model of drivers, outcomes and moderators. *Journal of Marketing Theory and Practice*, 26(1-2), 23-37. <https://doi.org/10.1080/10696679.2017.1389241>
- Charoennan, W., & Huang, K. P. (2018). The antecedents and consequences of conspicuous consumption of luxury fashion goods in a social media platform. *International Journal of Organizational Innovation*, 11(1), 1-20.
- Cheung, C. M. K., & Thadani, D. R. (2012). The impact of electronic word-of-mouth communication: a literature analysis and integrative model. *Decision Support Systems*, 54(1), 461-470.
- Chiu, T.-S., Chih, W.-H., Ortiz, J., & Wang, C.-Y. (2018). The contradiction of trust and uncertainty from the viewpoint of swift guanxi. *Internet Research*, 28(3), 716-745.
- Chopdar, K. P., & Sivakumar, V. J. (2018). Understanding psychological contract violation and its consequences on mobile shopping applications use in a developing country context. *Journal of Indian Business Research*, 10(2), 208-231.

- Delgado-Ballester, E., Munuera-Aleman, J.L., & Jesús-Yagüe, M. (2003). Development and Validation of a Brand Trust Scale. *International Journal of Market Research*, 45(1), 35-56.
- Dept. of household Registration. (2018). *Statistics*. Retrieved from <https://www.ris.gov.tw/app/en/3910>
- Dowling, G. R., & Staelin, R. (1994). A model of perceived risk and intended risk-handling activity. *Journal of Consumer research*, 21(1), 119-134.
- eMarketer. (2019). *How significant is social commerce, and how fast is it growing?* Retrieved from <https://www.emarketer.com/content/social-commerce-2019>
- Featherman, M., & Pavlou, P. A. (2003). Predicting e-services adoption: a perceived facets perspective. *International Journal of Human-Computer Studies*, 59(4), 451-474.
- Filo, K., Lock, D., & Karg, A. (2015). Sport and social media research: a review. *Sport Management Review*, 18(2), 166-181.
- Fornell, C., & Larcker, D. F. (1981). Evaluating structural equation models with unobservable variables and measure error. *Journal of Marketing Research*, 18(1), 39-50.
- Gambetti, R. C., Biraghi, S., Schultz, D. E., & Graffigna, G. (2015). Brand wars: consumer-brand engagement beyond client-agency fights. *Journal of Strategic Marketing*, 24(2), 1-14.
- Gefen, D., Karahanna, E., & Straub, D. W. (2003). Trust and TAM in online shopping: an integrated model. *MIS Quarterly*, 27(1), 51-90.
- Goles, T., Rao, S. V., Lee, S., & Warren, J. (2009). Trust violation in electronic commerce: customer concerns and reactions. *Journal of Computer Information Systems*, 49(4), 1-9.
- Hair, J. F. Jr., Black, W. C., Babin, B. J., Anderson, R. E., & Tatham, R. L. (2006). *Multivariate Data Analysis* (6th Ed.), Upper Saddle River, NJ: Pearson Prentice Hall.
- Hajli, N. (2018). Ethical environment in the online communities by information credibility: a social media perspective. *Journal of Business Ethics*, 149(4), 799-810.
- Hajli, N., Lin, X., Featherman, M., & Wang, Y. (2014). Social word of mouth: how trust develops in the market. *International Journal of Market Research*, 56(5), 673-689.
- Hill, J. A., Eckerd, S., Wilson, D., & Greer, B. (2009). The effect of unethical behavior on trust in a buyer-supplier relationship: the mediating role of psychological contract violation. *Journal of Operations Management*, 27(4), 281-293.
- Hoffman, D. L., & Fodor, M. (2010). Can you measure the ROI of your social media marketing? *MIT Sloan Management Review*, 52(1), 41-49.
- Hooper, D., Coughlan, J., & Mullen, M. R. (2008). Structural equation modelling: guidelines for determining model fit. *Electronic Journal of Business Research Methods*, 6(1), 53-60.
- Hunt, S. D., & Lambe, C. J. (2000). Marketing's contribution to business strategy: market orientation, relationship marketing and resource-advantage theory. *International Journal of Management Reviews*, 2(1), 17-43.
- INDEPENDENT. (2019). *Facebook data scandal: Social network fined \$5bn over 'inappropriate' sharing of users' personal information*. Retrieved from <https://www.independent.co.uk/news/world/americas/facebook-data-privacy-scandal-settlement-cambridge-analytica-court-a9003106.html>
- Jarvenpaa, S. L., Tractinsky, N., & Vitale, M. (2000). Consumer trust in an internet store. *Information Technology and Management*, 1(1-2), 45-71.
- Kalakota, R., & Whinston, A. B. (1996). *Frontiers of electronic commerce*. Boston, MA: Addison-Wesley, Reading.
- Kellerman, K., & Reynolds, R. (1990). When ignorance is bliss the role of motivation to reduce uncertainty in uncertainty reduction theory. *Human Communication Research*, 17(1), 5-15.
- Kim, A., & Ko, E. (2012). Do social media marketing activities enhance customer equity? An empirical study of luxury fashion brand. *Journal of Business Research*, 65(10), 1480-1486.
- Koh, C., Ang, S., & Straub, D. (2004). IT outsourcing success: a psychological contract perspective. *Information Systems Research*, 15(4), 356-373.
- Li, R., & Suh, A. (2015). "Factors influencing information credibility on social media platforms: evidence from Facebook pages", *Procedia Computer Science*, 72, 314-328.
- Liang, T. P., Ho, Y. T., Li, Y. W., & Turban, E. (2011). What drives social commerce: the role of social support and relationship quality. *International Journal of Electronic Commerce*, 16(2), 69-90.
- Lissitz, R. W., & Green, S. B. (1975). Effect of the number of scale points on reliability: A Monte Carlo approach. *Journal Applied. Psychology*, 60(1), 10-13.
- Mackie, D. M. (1986). Social identification effects in group polarization. *Journal of Personality and Social Psychology*, 50(4), 720-728.
- Malhotra, N., Sahadev, S., & Purani, K. (2017). Psychological contract violation and customer intention to reuse online retailers: exploring mediating and moderating mechanisms. *Journal of Business Research*, 75, 17-28.

- Mayer, R. C., Davis, J. H., & Schoorman, F. D. (1995). An integrative model of organizational trust. *Academy of Management Review*, 20(3), 709-734.
- Mehrabian, A., & Russell, A. (1974). *An approach to environmental psychology*. Cambridge, MA: MIT Press.
- Muntinga, D. G., Moorman, M., & Smit, E. G. (2011). Introducing COBRAs: exploring motivations for brand-related social media use. *International Journal of Advertising*, 30(1), 13-46.
- Ng, C. S. P. (2013). Intention to purchase on social commerce websites across cultures: a cross-regional study. *Information & Management*, 50(8), 609-620.
- Nunnally, J. C. (1978). *Psychometric Theory*. New York, NY: McGraw-Hill.
- Pai, P. Y., & Tsai, H. T. (2011). How virtual community participation influences consumer loyalty intentions in online shopping contexts: an investigation of mediating factors. *Behaviour and Information Technology*, 30(5), 603-615.
- Pantano, E., & Di Pietro, L. (2012). Understanding consumer's acceptance of technology-based innovations in retailing. *Journal of Technology Management and Innovation*, 7(4), 1-19.
- Park, M. S., Shin, J. K., & Ju, Y. (2014). The effect of online social network characteristics on consumer purchasing intention of social deals. *Global Economic Review*, 43(1), 25-41.
- Pavlou, P. A., & Gefen, D. (2005). Psychological contract violation in on line marketplaces: antecedents, consequences, and moderating role. *Information Systems Research*, 16(4), 372-399.
- Podsakoff, P. M., & Organ, D. W. (1986). Self-reports in organizational research: problems and prospects. *Journal of Management*, 12(4), 531-544.
- Prendergast, G., Ko, D., & Yuen, S. Y. V. (2010). Online word of mouth and consumer purchase intentions. *International Journal of Advertising*, 29(5), 687-708.
- Rehman, S. U., Bhatti, A., Mohamed, R., & Ayoup, H. (2019). The moderating role of trust and commitment between consumer purchase intention and online shopping behavior in the context of Pakistan. *Journal of Global Entrepreneurship Research*, 9(43). <https://doi.org/10.1186/s40497-019-0166-2>
- Shanmugam, M., Sun, S., Amidi, A., Khani, F., & Khani, F. (2016). The applications of social commerce constructs. *International Journal of Information Management*, 36(3), 425-432.
- SlideShare. (2019). *Digital 2019 Taiwan (January 2019) v01*. Retrieved from <https://www.slideshare.net/DataReportal/digital-2019-taiwan-january-2019-v01>
- Sozer, E. G. (2019). The effect of message valence on e-WOM spread: a moderated mediation analysis. *Business and Economics Research Journal*, 10(2), 541-555.
- Statista. (2019). *Social Media Statistics & Facts*. Retrieved from <https://www.statista.com/topics/1164/social-networks/>
- Tajfel, H. (1979). Individuals and groups in social psychology. *British Journal of Social and Clinical Psychology*, 18(2), 183-190.
- Tidwell, M. V. (2005). A social identification model of prosocial behaviors within nonprofit organizations. *Nonprofit Management and Leadership*, 15(4), 449-467.
- Turner, J. C. (1975). Social comparison and social identification: some prospects for intergroup behavior. *European Journal of Social Psychology*, 5(1), 5-34.
- Wang, Y. S., Wang, Y. M., Lin, H. H., & Tang, T. I. (2003). Determinants of user acceptance of internet banking: an empirical study. *International Journal of Service Industry Management*, 14(5), 501-519.
- Wu, Y. L., & Li, E. Y. (2018). Marketing mix, customer value, and customer loyalty in social commerce: a stimulus-organism-response perspective. *Internet Research*, 28(1), 74-104.
- Yin, X., Wang, H., Xia, Q., & Gu, Q. (2019). How social interaction affects purchase intention in social commerce: a cultural perspective. *Sustainability*, 11, 2423. <https://www.mdpi.com/2071-1050/11/8/2423>



The Difference in Competitiveness of Indonesian Biodiesel between Spain and the EU

Yoyon Muzayyin¹, Dwidjono Hadi Darwanto², Masyhuri²

¹ Doctor in Agribusiness Management interest, Study Program of Agricultural Science, Faculty of Agriculture, Gadjah Mada University. Jl. Flora Bulaksumur, Karang Malang, Caturtunggal, Depok, Sleman, Special Region of Yogyakarta, Indonesia, 55281. Email: ymuzayyin1@gmail.com

² Department of Agricultural Socio-Economics, Faculty of Agriculture, Gadjah Mada University. Jl. Flora Bulaksumur, Karang Malang, Caturtunggal, Depok, Sleman, Special Region of Yogyakarta, Indonesia, 55281. Email: dwidjonohd.osek@ugm.ac.id, masyhuri@ugm.ac.id

Correspondence: Prof. Dr. Ir. Masyhuri. Email: masyhuri@ugm.ac.id

Abstract

The purpose of this paper is to find the competitiveness of Indonesia's biodiesel exports in the Spanish and the European Union (EU) market as a whole using some competitiveness analysis approaches. In addition to knowing the similarities and differences in the results of the methods of analyzing the competitiveness of Indonesian biodiesel in Spain and the EU. The methodology used was comparative advantage analysis, including analysis of RCA, RSCA, and NRCA and market share. The data used are the value of biodiesel and total monthly exports of both Indonesia and other countries to Spain and the EU from January 2012 to January 2019. Through the market share approach, it was known that Indonesia's biodiesel market share in the Spanish and EU markets was only 22 percent and 0.04, respectively with an increasing trend in Spain and a decreasing trend in the EU. Each method for measuring competitiveness shows the similarity of results. Indonesia's biodiesel had competitiveness, both in Spain and the EU. Indonesia's biodiesel competitiveness trends are declining of all methods, both in the Spanish and EU markets, except the RCA method for Spain. Indonesia's biodiesel competitiveness is relatively better in Spain than the EU. The originality that there was not paper on the theme of the comparative competitiveness of Indonesia's biodiesel exports in Spain and the EU. This paper also proposes new criteria for determining competitiveness using existing competitiveness analysis methods. This can be input to determine better steps in marketing Indonesian biodiesel to Spain and the EU.

Keywords: Bioenergy, Comparative Advantage, Market Share, Symmetric, Normalized, Monthly, Ultimate; Extreme, Weak, Strong

1. Introduction

Bioenergy is a renewable energy that increases energy security (Vega-quezada et al., 2016). Biodiesel is one type of bioenergy that is increasingly known lately. Because of its advantages compared to fossil energy sources, especially more friendlies to the environment, making biodiesel can be a good alternative energy source to overcome greenhouse gases that trigger global warming (Prapaspongsa & Gheewala, 2017).

Many countries are involved in biodiesel trade. Biodiesel is needed in all regions of the world, one of which is the EU. Compared to other regions, biodiesel exports to the EU with the HS code for 382600 biodiesels are greater than in other regions in the world. Based on data from the ITC (2020), EU biodiesel imports in 2018 are 84 percent of world imports as a whole. Biodiesel imports of the EU in 2018 amounted to 11,834.282 million USD.

Spain is an importer of biodiesel importers in the EU. The overall value of Spanish biodiesel imports in 2018 amounted to 1,299.881 million USD. This import value is quite large when compared to many other biodiesels importing countries in the EU except the Netherlands and Belgium.

Indonesia is one of the world's biodiesel exporters that exports to the EU. One of the marketing areas is Spain. Compared among many destination countries for Indonesia's biodiesel exports in the EU, and even Europe in general. Spain is Indonesia's main biodiesel marketing destination. The value of Indonesia's biodiesel exports in Spain reached 362,337 million USD.

Competitiveness can be used to make certain policies (Muzayyin et al., 2019). This paper aims to determine the market share and competitiveness of Indonesian biodiesel in Spain when compared to the EU using several analytical methods, so it is known that the possible similarity of the results leads to increased confidence in the level of competitiveness of Indonesian biodiesel in the Spanish and the EU market.

2. Biodiesel in the EU

Biodiesel is a liquid fuel in addition to bioethanol which is used to fuel transportation and can increase energy security in the EU. It is planned that each EU country uses 10% of renewable energy, including biodiesel (European Commission, 2014).

EU Biodiesel consumption has increased in Europeans, including the EU. Biodiesel production in the EU uses the main raw material of rapeseed (EUBIA, 2020).

3. Previous research and novelty

Many writers raised the material on biodiesel exports, but only a few authors wrote the competitiveness of biodiesel. Dewanta et al. (2016) concerning the elasticity and competitiveness of the Indonesian commodity in the Indian market but commodity was palm oil and Pambudi et al. (2019) concerning the determinants of biodiesel exports in Indonesia, and no writings were found that wrote the competitiveness of Indonesia's biodiesel exports on the Spanish or EU markets. So be convinced that this paper is different from previous papers. Data analysis used is monthly data, where most authors use annual data.

4. Methodology

Competitiveness in this paper was measured using comparative advantage and market share (MS). To conduct an investigation of comparative advantage using RCA (Revealed Comparative Advantage) analysis, RSCA (Revealed Symmetric Comparative Advantage), and NRCA (Normalized Revealed Comparative Advantage). Some analyzes were used with the intention that the results obtained are more reliable. By comparing the results of one analysis with another, a better conclusion will be obtained. The analysis were written as follows.

4.1 RCA analysis

Balassa RCA Analysis (1965) was used to measure the competitiveness of exports of biodiesel Indonesia, in this paper follows the equation which was also used by Kathuria (2013) in his paper was rewritten as follows:

$$RCA_{ijk} = (X_{ijk}/X_{wjk})/(X_{ij}/X_{wj})$$

X showed the value of exports, Indonesia as an exporter of biodiesel in this paper was symbolized by i , an export destination with j , commodity (biodiesel) with k , and the world with w .

If the RCA index was more than 1, it would mean that there was a comparative advantage or competitiveness. To interpret the results more thoroughly, the determination of results can be used according to Erkan & Yildirimci (2015) sourced from Hinloopen & Marrewijk (2001) with an expanded classification, Classification 5 and 6 as shown in Table 1.

Table 1 Determination of RCA analysis results

Categories	RCA value	Interpretation
Classification 1	$0 < RCA \leq 1$	There was no competitiveness
Classification 2	$1 < RCA \leq 2$	There was a weak competitiveness
Classification 3	$2 < RCA \leq 4$	There was a medium competitiveness
Classification 4	$4 < RCA \leq 8$	There was a strong competitiveness
Classification 5	$RCA > 8$	There was an extreme competitiveness

Source: Hinloopen & Marrewijk (2001); Erkan & Yildirimci (2015).

4.2 RSCA analysis

The RSCA analysis proposed by Dalum et al. (1998) was a refinement of the Balassa RCA analysis. The RSCA analysis follows the equation written by Van Hoang et al. (2017) as follows:

$$RSCA_{ijk} = (RCA_{ijk} - 1) / (RCA_{ijk} + 1)$$

The results of the RSCA analysis were between -1 and +1, avoiding the zero value problem (Hoang et al., 2017). The determination of RSCA results can be seen in the following Table 2:

Table 2 Determination of RSCA analysis results

Categories	RSCA value	Interpretation
Classification 1	$-1 \leq RSCA < 0$	There was no competitiveness
Classification 2	$0 = RSCA$	Neutral
Classification 3	$0 < RSCA \leq 1$	There was a competitiveness

Source: Hoang et al. (2017) expanded.

4.3 NRCA analysis

NRCA analysis was first proposed by Yu et al. (2009). According to Hoang et al. (2017), NRCA analysis was one alternative and improvement of the Balassa RCA analysis. NRCA was symmetrical because it produces a value between -0.25 to +0.25 with a value of 0 as the midpoint/balance between the two values. The NRCA equation was as follows:

$$NRCA_{ijk} = (X_{ijk} / X_{wj}) - (X_{ij}X_{wjk} / X_{wk}X_{wk})$$

The determination of the results of NRCA analysis can be seen in Table 3.

Table 3 Determination of NRCA analysis results

Categories	NRCA value	Interpretation
Classification 1	$-0.25 \leq NRCA < 0$	There was no competitiveness
Classification 2	$0 = NRCA$	Neutral
Classification 3	$0 < NRCA \leq 0.25$	There was a competitiveness

Source: Hoang et al. (2017) expanded.

4.4 MS analysis

Market share is the percentage of a market in units or revenue recorded by a particular entity (Wikipedia, 2012). Han et al. (2009) wrote MS as follow:

$$MS_{ijk} = X_{ijk}/X_{iw}$$

MS_{ijk} was the Indonesian biodiesel market to the destination.

5. Result

5.1 RCA index

The results of the analysis of the competitiveness of Indonesian biodiesel in the Spanish and EU markets using the RCA analysis method were displayed in the form of Fig. 1 and Table 4.

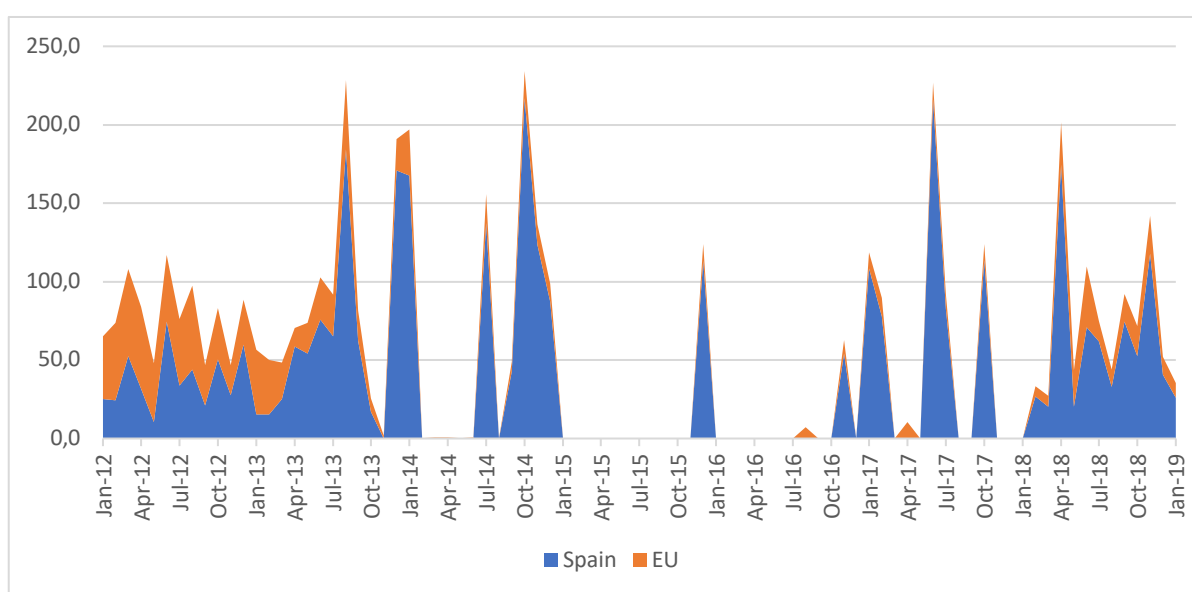

Fig. 1 Indonesia's biodiesel comparative advantage in the Spanish and the EU market using the RCA index from January 2012 till January 2019 (Source: own calculation based on ITC data, 2019).

Table 4 Comparison of comparative advantage of Indonesian biodiesel in the Spanish and the EU market using the RCA index from 2012 till 2018.

Year	RCA index	
	The Spanish market	The EU market
2012	38.0 (Ultimate competitiveness)	39.8 (Ultimate competitiveness)
2013	62.0 (Ultimate competitiveness)	23.1 (Ultimate competitiveness)
2014	64.6 (Ultimate competitiveness)	8.2 (Extreme competitiveness)
2015	9.4 (Extreme competitiveness)	1.0 (Weak competitiveness)
2016	4.5 (Strong competitiveness)	1.3 (Weak competitiveness)
2017	49.9 (Ultimate competitiveness)	5.2 (Strong competitiveness)
2018	57.8 (Ultimate competitiveness)	16.6 (Ultimate competitiveness)
Average	40.9 (Ultimate competitiveness)	13.6 (Extreme competitiveness)
Trend	Strengthen up	Weakened

Source: own calculation based on ITC data (2019).

5.2 RSCA index

The results of the analysis of the competitiveness of Indonesian biodiesel in the Spanish and EU markets using the RSCA analysis method were displayed in the form of Fig. 2 and Table 5.

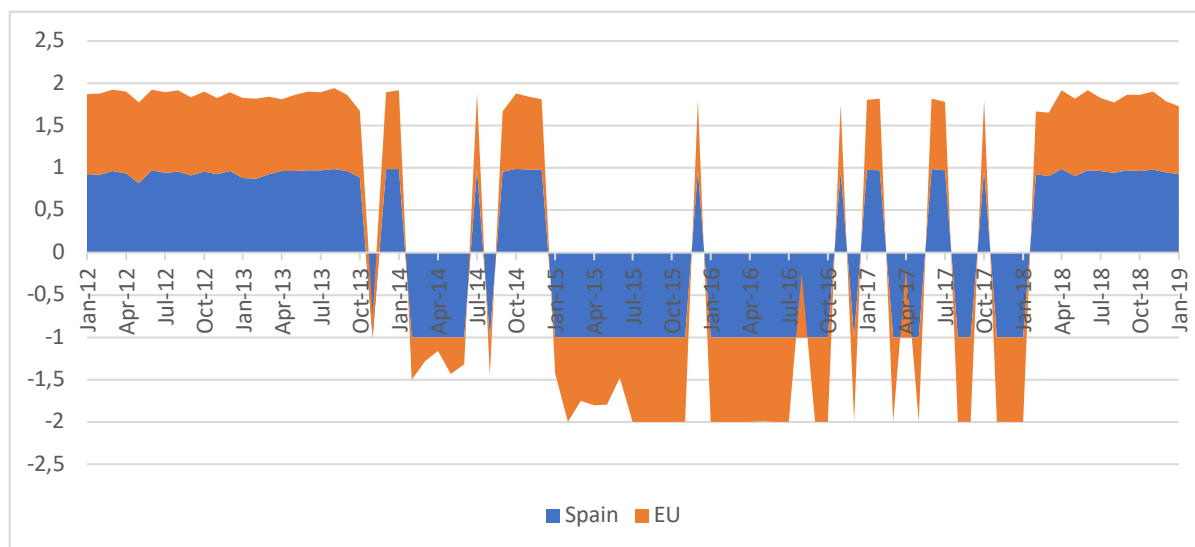

Fig. 2 Indonesia's biodiesel comparative advantage in the Spanish and the EU market using RSCA index from January 2012 till January 2019 (Source: own calculation based on ITC data, 2019).

Table 5 Comparison of comparative advantage of Indonesian biodiesel in the Spanish and the EU market using RSCA index from 2012 till 2018

Year	RSCA index	
	The Spanish market	The EU market
2012	0.93 (Strong competitiveness)	0.95 (Strong competitiveness)
2013	0.78 (Strong competitiveness)	0.85 (Strong competitiveness)
2014	-0.01 (No competitiveness)	0.25 (Weak competitiveness)
2015	-0.83 (No competitiveness)	-0.70 (No competitiveness)
2016	-0.84 (No competitiveness)	-0.70 (No competitiveness)
2017	-0.17 (No competitiveness)	-0.09 (No competitiveness)
2018	0.79 (Strong competitiveness)	0.71 (Strong competitiveness)
Average	0.09 (Weak competitiveness)	0.18 (Weak competitiveness)
Trend	Weakened	Weakened

Source: own calculation based on ITC data (2019).

5.3 NRCA index

The results of the analysis of the competitiveness of Indonesian biodiesel in the Spanish and EU markets using the NRCA analysis method were displayed in the form of Fig. 3 and Table 6.

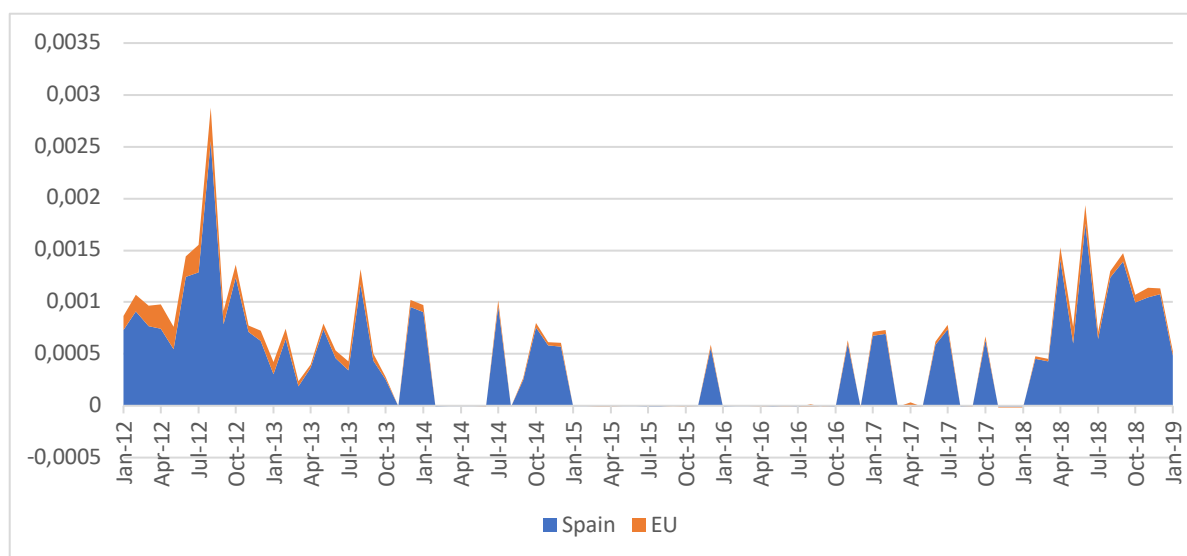

Fig. 3 Indonesia's biodiesel comparative advantage in the Spanish and the EU market using the NRCA index from January 2012 till January 2019 (Source: own calculation based on ITC data, 2019).

Table 6 Comparison of comparative advantage of Indonesian biodiesel in the Spanish and the EU market using NRCA index from 2012 till 2018

Year	NRCA index	
	The Spanish market	The EU market
2012	0.0010121 (Weak competitiveness)	0.0001781 (Weak competitiveness)
2013	0.0004878 (Weak competitiveness)	0.0000685 (Weak competitiveness)
2014	0.0003328 (Weak competitiveness)	0.0000193 (Weak competitiveness)
2015	0.0000423 (Weak competitiveness)	0.0000003 (Weak competitiveness)
2016	0.0000436 (Weak competitiveness)	0.0000021 (Weak competitiveness)
2017	0.0002718 (Weak competitiveness)	0.0000168 (Weak competitiveness)
2018	0.0009192 (Weak competitiveness)	0.0000783 (Weak competitiveness)
Average	0.0004428 (Weak competitiveness)	0.0000519 (Weak competitiveness)
Trend	Weakened	Weakened

Source: own calculation based on ITC data (2019).

5.4 MS

The movement of the monthly market share and the magnitude of Indonesia's biodiesel annual market share can be seen in Fig. 4 and Table 7.

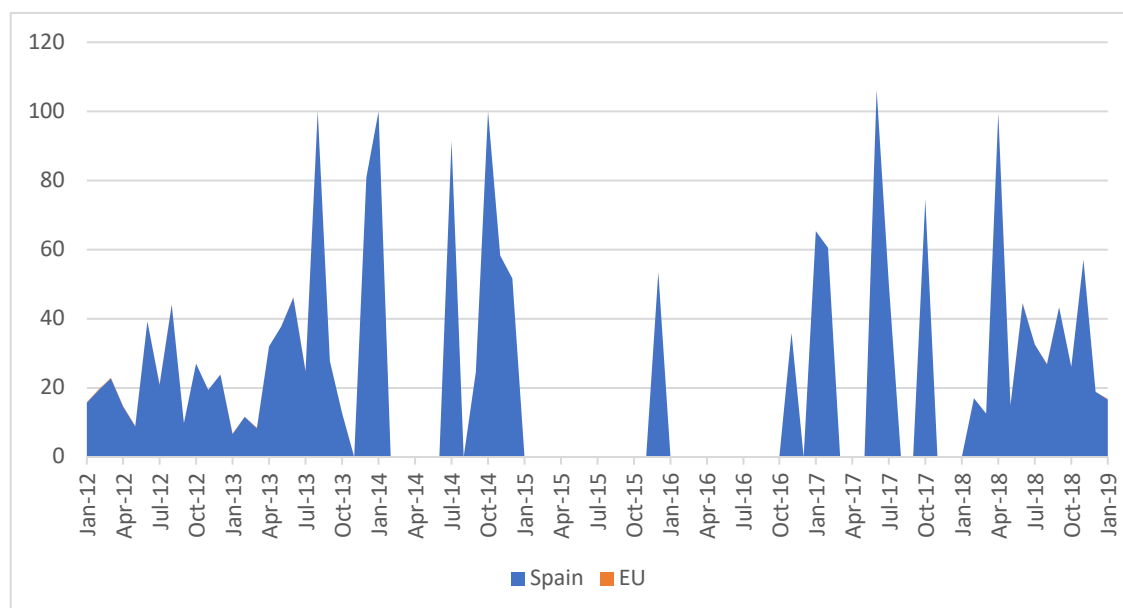

Fig. 4 Market shares of Indonesian biodiesel in the Spanish and the EU market from January 2012 till January 2019 (Source: own calculation based on ITC data, 2019).

Table 7 Summary of the market share of Indonesian biodiesel in the Spanish and the EU market from 2012 till 2018

Year	MS	
	The Spanish market	The EU market
2012	22.121	0.123
2013	32.389	0.067
2014	35.499	0.023
2015	4.455	0.003
2016	2.997	0.004
2017	29.740	0.015
2018	32.794	0.043
Average	22.286	0.040
Trend	Increase	Decrease

Source: own calculation based on ITC data (2019).

6. Discussion

6.1 Indonesia's biodiesel exports to Spain compared to other countries in the EU

Fluctuations in Indonesia's biodiesel exports to all countries in the world compared to the EU and Spain have a similar pattern. The percentage of Indonesia's biodiesel exports to Spain against the EU from January 2012 to January 2019 was 76.6 percent. There are several months that all of Indonesia's biodiesel exports to Spain compared to the EU are 100 percent, namely in October and December 2014, December 2015, November 2016, January, February, June, July, October 2017, February, March, September, and December 2018. This shows that Spain is the main destination country for Indonesia's biodiesel exports in the EU (see Fig. 5).

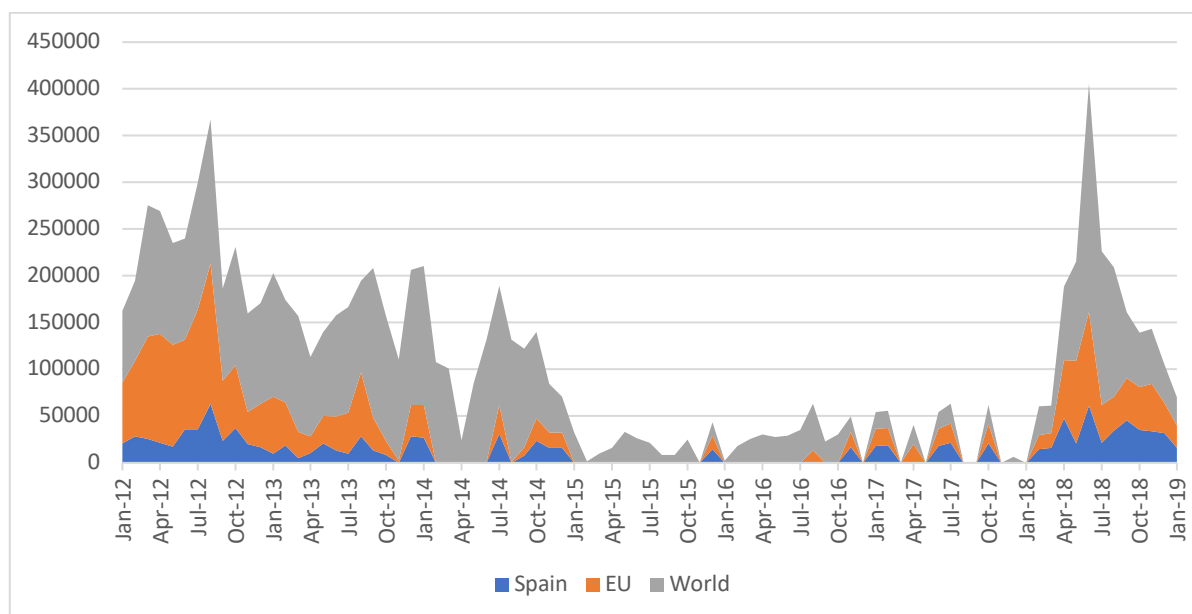

Fig. 5 The value of Indonesia's biodiesel exports to Spain is compared to the EU and the world (Source: own calculation based on ITC data, 2019).

Table 8 shows the 5 destination countries for Indonesia's biodiesel exports in the EU. The rating shows the number of exports expressed in percent. The difference between the top rankings (Spain) and last (Germany) and the average ranking below them are 65,361 percent and 57,155 percent respectively, making Spain very prominent as Indonesia's biodiesel market in the EU. In addition to the large percentage of exports, Indonesia's biodiesel export continuity is also maintained year after year.

Table 8 Percentage of Indonesia's biodiesel exports to Spain compared to other EU countries (Italy, Germany, the Netherlands, and Belgium) of Indonesia's biodiesel exports to the EU

Year	Spain (%)	Italy (%)	Netherlands (%)	Belgium (%)	Germany (%)
2012	32.478	29.173	36.584	1.032	0.085
2013	40.109	23.822	35.167	0.062	0.840
2014	90.262	0.000	8.253	0.000	1.485
2015	91.077	0.000	5.997	2.926	0.000
2016	55.268	44.708	0.000	0.007	0.000
2017	82.696	17.304	0.000	0.000	0.000
2018	68.044	5.339	22.780	3.837	0.000
Average	65.705	17.192	15.540	1.123	0.344
Rank	1	2	3	4	5
Trend	Increase	Decrease	Decrease	Increase	Decrease/lose

Source: own calculation based on ITC data (2019).

6.2 Indonesia's biodiesel market share in the Spanish and EU markets

One of the uses of market share analysis is that business managers can measure the performance of a product or commodity in the market place (Cooper, 1988). The average market share of Indonesian biodiesel from January 2012 to January 2019 on the Spanish and EU markets was 22,784 percent and 0.040 percent, respectively. The largest monthly market share in Spain reached 100 percent, namely in August 2013 and July 2017, while the smallest reached 6.669 percent and even Indonesia biodiesel has lost its market share several times including in November 2013, February-June 2014, August 2014, January-November 2015, January-October 2016, December 2016, March-May 2017, August-September 2017, November 2017-January 2018. Indonesia's highest biodiesel market share in the EU only reached 0.169 percent, which occurred in August 2012, while the lowest reached

0.000012 percent even as in Spain lost its market share occurred in February 2015, July-November 2015, January-April 2016, June-July 2016, September-October 2016, December 2016, March 2017, May 2017, August-September 2017, November - December 2017, January 2018 (Fig. 4).

Thus, it can be seen that the calculation of the monthly market share is different from the annual (see Table 7). The largest and smallest monthly and annual market share of Indonesia's biodiesel in Spain is 64.501 percent and 3.672 percent, respectively (not taking into account the absence of market share). The largest and smallest monthly and annual market share differences in Indonesian biodiesel in the EU are 0.046 percent and -0.030 percent, respectively (not taking into account the lack of market share).

There seems to be a vast difference in Indonesia's biodiesel market share in Spain when compared to the EU. The average market share of Indonesia's biodiesel in Spain is relatively much higher compared to the EU. In addition to the large market share, market share trends are also different. The magnitude and trend of Indonesia's biodiesel market share which is increasing in Spain is an expectation that Indonesian biodiesel will be able to be marketed better in Spain. However, the relatively small market share and the downward trend in Indonesia's biodiesel market share in the EU market as a whole is a sign of the unfavorable marketing of Indonesia's biodiesel on the EU market. This is in line with the fact that the marketing of Indonesia's biodiesel to the EU is experiencing many obstacles.

Regarding the movement of Indonesia's biodiesel market share in both the Spanish and EU markets can be seen in Fig. 4. There is no visible movement in the EU market share because the market share is relatively very small when compared to market share in Spain. The loss of market share was due to unrecorded biodiesel exports to Spain during that period.

6.3 The comparative advantages of Indonesian biodiesel on the Spanish and EU markets

6.3.1 Measured competitiveness using the RCA index

Overall from January 2012 to January 2019, the average RCA index of Indonesian biodiesel on the Spanish and EU markets was 32,289 and 13,557, respectively. This means that the average competitiveness of Indonesia's biodiesel on the Spanish market was ranked ultimately, while in the EU market it was ranked extremely. This showed that according to the RCA analysis, both in the Spanish market in particular and the EU in general Indonesian biodiesel had quite a good competitiveness.

6.3.1.1 The competitiveness of Indonesian biodiesel in Spain according to the RCA analysis

The competitiveness of Indonesian biodiesel in Spain according to analysis fluctuated from month to month, wherefrom January 2012 to January 2019, the best gains in competitiveness marked by the highest RCA index (RCA index 216,945) were found in October 2014 and the worst (RCA index 10,313) occurred in May 2012. This means that Indonesia's biodiesel competitiveness was in a condition between the extreme and ultimate level.

From January 2012 to October 2013 in a row, Indonesia's biodiesel gained competitiveness and was in quite a good condition, at least at extreme levels. After that, there was a change in conditions between the acquisition of competitiveness and loss of competitiveness, but if there was a gain of competitiveness, the minimum level was ultimate. Indonesia also lost its competitiveness in the longest period, from January to November 2015. Sustainable competitiveness was again achieved by Indonesian biodiesel, namely from February 2018 to January 2019 with conditions at least at the ultimate level. Based on the RCA analysis which is conducted monthly by looking at the beginning and end of the analysis period (January 2012 and January 2019) shows that there is a tendency to strengthen the competitiveness of Indonesian biodiesel in Spain. Fluctuations in the movement of the RCA index of Indonesian biodiesel in Spain every month can be seen in Fig. 1.

The annual difference between the RCA indexes of Indonesian biodiesel in Spain from 2012 to 2018 was between the highest and the lowest quite large, which is 60.1. During this period, Indonesian biodiesel in Spain gained

competitiveness. Indonesia's biodiesel competitiveness in Spain was at least in a strong position. The strength of competitiveness fluctuated but the tendency strengthened. More details about this can be seen in Table 4.

6.3.1.2 The competitiveness of Indonesian biodiesel in the EU according to the RCA analysis

Fluctuations in Indonesia's biodiesel competitiveness in the EU occur from month to month, wherefrom January 2012 to January 2019, Indonesian biodiesel in the EU reached the highest degree of competitiveness marked by the highest RCA index (RCA index 55,448) occurred in March 2012 and the worst being marked with the lowest RCA index (1,722 RCA index) occurred in November 2013. This means that from January 2012 to January 2014 respectively, Indonesian biodiesel gained competitiveness with the ultimate majority level even though some were at a weak level (occurring in November 2013).

After that, there is a change in conditions between the acquisition of competitiveness and loss of competitiveness, but in the event of the acquisition of competitiveness the minimum level of competitiveness is strong. Indonesia lost consecutive competitiveness with the longest period from January to November 2015. Indonesia's biodiesel in the EU regained its sustainable competitiveness from February 2018 to January 2019 with minimal conditions at strong levels. Based on the RCA analysis which is conducted monthly by looking at the beginning and end of the analysis period (January 2012 and January 2019) shows that there is a tendency to weaken the competitiveness of Indonesian biodiesel in the EU. Fluctuations in the movement of the RCA index of Indonesian biodiesel in the EU every month can be seen in Fig. 1.

Throughout 2012 to 2018 there was always a gain in competitiveness, except for 2015. The difference between the annual Indonesian RCA biodiesel index in the EU from 2012 to 2018 between the highest and lowest was also quite large, amounting to 38.8. If Indonesian biodiesel in the EU gains competitiveness, it is at least in a weak position. Competitiveness strength fluctuates but tends to weaken (see Table 4).

6.3.2 Measured competitiveness using the RSCA index

Overall from January 2012 to January 2019, the average RSCA index of Indonesian biodiesel on the Spanish and EU markets was 0.1028 and 0.1878, respectively. This means that Indonesian biodiesel, both in the Spanish and EU markets are equally competitive despite being weak. The competitiveness of Indonesian biodiesel in Spain is slightly weaker than in the EU.

6.3.2.1 Indonesia's biodiesel competitiveness in Spain according to the RSCA index

The competitiveness of Indonesia's biodiesel in Spain also fluctuates from month to month. From January 2012 to January 2019, based on the RSCA index, the best competitiveness was marked by the highest RSCA index (RSCA index 0.990823) in October 2014 and the worst was marked by the lowest RSCA index (RSCA index 0.82321) in May 2012. This means that Indonesia's biodiesel competitiveness in Spain is at a strong level. Overall, if there is a gain in competitiveness, then it is at a strong level.

From January 2012 to October 2013 in a row, Indonesia's biodiesel gained competitiveness. After that there is a change in conditions between the acquisition of competitiveness and loss of competitiveness. Biodiesel Indonesia had lost its competitiveness in the longest period, ie from January to November 2015. The acquisition of sustainable competitiveness again occurred from February 2018 to January 2019. Based on the RSCA analysis which is conducted monthly by looking at the beginning and end of the analysis period (January 2012 and January 2019) shows that there is a tendency to strengthen the competitiveness of Indonesian biodiesel in Spain, although it is relatively very small. Fluctuations in the movement of the RSCA index of Indonesian biodiesel in Spain every month can be seen in Fig. 2.

The annual RSCA biodiesel index difference in Indonesia in Spain from 2012 to 2018 is between the highest and the lowest quite large, which is 0.94 (almost close to +1). If you gain competitiveness, Indonesian biodiesel in Spain is also in a very strong position. Between 2014 and 2017, Indonesia's biodiesel lost its competitiveness and

when viewed from the beginning and end of the period, there was a tendency to experience a weakening of competitiveness. Regarding this matter can be seen in Table 5.

6.3.2.2 Indonesia's biodiesel competitiveness in the EU according to the RSCA index

Starting from January 2012 to January 2019, Indonesia's biodiesel competitiveness has fluctuated from month to month. In Indonesia's biodiesel exports to the EU, the best gains in competitiveness marked by the highest RSCA index (RSCA index 0.9646) occurred in March 2012 and the worst marked by the lowest RSCA index (RSCA index 0.2652) occurred in November 2013. This shows that biodiesel Indonesia in the EU market is at a level between weak to strong.

By looking at the RSCA index, from January 2012 to January 2014 Indonesian biodiesel in the EU gained successive competitiveness even though some were at a weak level, namely in November 2013 (the rest were at strong levels). After that, there is a change in conditions between the acquisition of competitiveness and loss of competitiveness, but in the event of the acquisition of competitiveness, the level of minimum competitiveness is strong. Indonesia also lost its competitiveness in the longest period from January 2015 to November 2015. The acquisition of sustainable competitiveness again occurred from February 2018 to January 2019 with minimal conditions at a strong level. Based on the RSCA analysis which is conducted monthly by looking at the beginning and end of the analysis period (January 2012 and January 2019) shows that there is a tendency to weaken the competitiveness of Indonesia's biodiesel in the EU. Fluctuations in the movement of Indonesian biodiesel in the EU based on the RSCA index every month can be seen in Fig. 2.

The annual RSCA biodiesel index difference in Indonesia in Spain from 2012 to 2018 between the highest and lowest is also quite large, which is 1.65. If Indonesian biodiesel in the EU gains minimal competitiveness, it will be in a weak position. Competitiveness strength fluctuates but tends to weaken (see Table 5).

6.3.3 Measured competitiveness using the NRCA index

Overall from January 2012 to January 2019, the average NRCA index of Indonesian biodiesel on the Spanish and EU markets was 0.000444 and 0.000052, respectively. This means that Indonesian biodiesel, both in the Spanish and EU markets are equally competitive despite being weak. The competitiveness of Indonesian biodiesel in Spain is stronger when compared to the EU.

6.3.3.1 The competitiveness of Indonesian biodiesel in Spain according to the NRCA index

Based on NRCA analysis, the competitiveness of Indonesian biodiesel in Spain has fluctuated from month to month. From January 2012 to January 2019, the best competitiveness which was marked by the highest NRCA index (NRCA index 0.002551) occurred in August 2012 and the worst marked by the lowest NRCA index (NRCA index 0.0001855) occurred in March 2013. This means that the competitiveness of Indonesia's biodiesel in Spain is at a weak level. Overall, if there is a gain in competitiveness, then it is at a weak level.

Between the period of January 2012 and October 2013, from the results of successive NRCA analyzes, Indonesian biodiesel gained competitiveness at a weak level. After that, there is a change in conditions between the acquisition of competitiveness and loss of competitiveness. Biodiesel Indonesia had lost its competitiveness in the longest period, namely from January to November 2015. The acquisition of sustainable competitiveness again occurred from February 2018 to January 2019. Based on the NRCA analysis which is conducted monthly by looking at the beginning and end of the analysis period (January 2012 and January 2019) shows that there is a tendency to weaken the competitiveness of Indonesian biodiesel in Spain. Fluctuations in competitiveness (movement of NRCA index) of Indonesian biodiesel in Spain every month can be seen in Fig. 3.

The annual NRCA biodiesel index difference in Spain from 2012 to 2018 is the highest with the lowest reaching 0.0009698. Biodiesel Indonesia gained competitiveness in the Spanish market during this period, but was in a weak position. Competitiveness tends to weaken. Regarding this condition can be seen in Table 6.

6.3.3.2 Indonesia's biodiesel competitiveness in the EU according to the NRCA index

Fluctuations in Indonesia's biodiesel competitiveness occur from month to month. From January 2012 to January 2019, there was Indonesia's biodiesel exports to the EU, the highest competitiveness was equal to RCA, namely in August 2012 with an NRCA index of 0.0003254, but the lowest was the same as the RSCA, which occurred in November 2013 with the NRCA index of 0.0000202. This means that each is at a low level of competitiveness.

Similar to the RCA and RSCA, based on NRCA analysis from January 2012 to January 2014 successively showed that Indonesia's biodiesel gained competitiveness despite all being at a weak level. After that, there is a change in conditions between the acquisition of competitiveness and the loss of competitiveness, and if the acquisition of competitiveness occurs the level of competitiveness is weak. Biodiesel Indonesia lost competitiveness in the longest period from January 2015 to November 2015. The acquisition of sustainable competitiveness again occurred from February 2018 to January 2019 with the condition of competitiveness at strong levels. Based on the NRCA analysis which is conducted monthly by looking at the beginning and end of the analysis period (January 2012 and January 2019) shows that there is a tendency to weaken the competitiveness of Indonesian biodiesel in the EU. Fluctuation in competitiveness (movement of NRCA index) of Indonesian biodiesel in the EU every month can be seen in Fig. 3.

From 2012 to 2018, Indonesian biodiesel in the EU gained competitiveness although it was weak. The annual NRCA biodiesel index difference in the EU from 2012 to 2018 between the highest and lowest is also quite large, which is equal to 0.0001778. The strength of competitiveness of Indonesian biodiesel in the EU is fluctuating, however, the tendency for competitiveness is weakening (see Table 6).

7 Conclusion and policy implication

Biodiesel Indonesia has a market share, both in Spain and in the EU. The average market share of Indonesian biodiesel in Spain is greater than in the EU in general. Market share in Spain is special because it only covers one country in the EU, while the market share in the EU besides Spain includes several other countries, including Germany, Italy, the Netherlands, and Belgium. It can be seen that Indonesia's biodiesel market share in other EU countries is no better than the market share in Spain. Indonesia's biodiesel market share even looks likely to improve when compared to the EU which tends not to improve.

It was known that Indonesia's biodiesel market share in the Spanish and EU markets was only 22 percent and 0.04, respectively with an increasing trend in Spain and a decreasing trend in the EU. Found that Indonesia's biodiesel had competitiveness, both in Spain and the EU. Each method for measuring competitiveness shows the similarity of results but is not exact. For the three competitiveness methods, Indonesia's biodiesel competitiveness trends are declining, both in the Spanish and EU markets, except the RCA method for the Spanish market. Based on the RCA method, both in the Spanish and EU markets show the competitiveness of each Ultimate and Extreme. Whereas using the RSCA and NRCA shows weak competitiveness in both the Spanish and EU markets. Indonesia's biodiesel competitiveness is relatively better in the Spanish market, compared to the EU market in general.

This condition can be an input for the Government of Indonesia to look back on the conditions that caused the acquisition and loss of competitiveness in the periods mentioned. Having known the causes of these conditions can be used as a basis for determining more appropriate strategies to obtain the competitiveness of Indonesia's biodiesel that is unbroken between one period to another or maintain that competitiveness.

Acknowledgment

We thank LPDP for the independent research funding support and Prof. Dr. Abdul Rohman, S. F., Apt., M.Si. for his guidance.

References

- Cooper, L. G. and Nakanishi, M. (1988), "Market Share Analysis: Evaluating Competitive Marketing Effectiveness", *Kluwer Academic Publishers*, United States of America.
- Dalum, B., Laursen, K. and Villumsen, G. (1998), "Structural change in OECD export specialisation patterns: de-specialisation and "stickiness"", *International Review of Applied Economics*, 12(3), pp. 423–443, doi: 10.1080/02692179800000017.
- Dewanta, A.S., Arfani, R. N., and Erfita (2016), "Elasticity and competitiveness of Indonesia's palm oil export in the India market", *Economic Journal of Emerging Markets*, 8(2), 148 - 158, doi: 10.20885/ejem.vol8.iss2.art7.
- Erkan, B. and Yildirimci, E. (2015), "Economic Complexity and Export Competitiveness: The Case of Turkey", *Procedia - Social and Behavioral Sciences*, Elsevier B.V., 195, pp. 524–533, doi: 10.1016/j.sbspro.2015.06.262.
- EUBIA (2020), "Biodiesel". *European Biomass Industry Association*, available at: <https://www.eubia.org/cms/wiki-biomass/biofuels/biodiesel/> (Accessed 5 January 2020).
- European Commission (2014), "Biofuels", available at: <https://ec.europa.eu/energy/en/topics/renewable-energy/biofuels/overview> (Accessed 5 January 2020).
- European Union (2019), "The 28 member countries of the EU", available at: https://europa.eu/european-union/about-eu/countries_en (Accessed 26 December 2019).
- Han, X., Wen, Y., and Kant, S. (2009), "Forest Policy and Economics The global competitiveness of the Chinese wooden furniture industry", *Forest Policy and Economics*, available at: <https://doi.org/10.1016/j.forpol.2009.07.006>.
- Hinloopen, J. and Marrewijk, C. V. (2001), "On the Empirical Distribution of the Balassa", *Weltwirtschaftliches Archiv*, 137(1), pp. 1–35, available at: <http://www.jstor.org/stable/40440821>.
- Hoang, V. V., Tran, K. T., Tu, B. V., Nguyen, V. N. and Nguyen, A. Q. (2017), "Agricultural competitiveness of vietnam by the RCA and the NRCA Indices, and consistency of competitiveness indices", *Agris On-line Papers in Economics and Informatics*, 9(4), pp. 53–67, doi: 10.7160/aol.2017.090406.
- ITC (2020), "List of importers for the selected product", available at: https://www.trademap.org/Country_SelProduct_TS.aspx?nvpm=1%7c%7c14719%7c%7c%7c382600%7c%7c%7c6%7c1%7c1%7c1%7c2%7c1%7c3%7c1%7c (Accessed 5 January 2020).
- Kathuria, L. M. (2013), "Analyzing competitiveness of clothing export sector of india and Bangladesh: Dynamic revealed comparative advantage approach", *Competitiveness Review*, 23(2), pp. 131–157, doi: 10.1108/10595421311305343.
- Muzayyin, Y., Masyhuri, Darwanto, D. H., Junaidi, E. (2019), "Competitiveness and protection policy: the case of Indonesian lobster exports to the Asian markets", *International Journal of Trade and Global Markets*, 12(3/4), pp. 260–271, doi: 10.1504/ijtgm.2019.101562.
- Pambudi, A., Puspitawati, E. and Nursechafia (2019), "The Determinants of Biodiesel Export in Indonesia", *Signifikan: jurnal ilmu ekonomi*, 8(2), 207-2016, doi: 10.15408/sjie.v8i2.1096.
- Prapasongsa, T. and Gheewala, S. H. (2017), "Consequential and attributional environmental assessment of biofuels: implications of modelling choices on climate change mitigation strategies", *International Journal of Life Cycle Assessment*, 22(11), pp. 1644–1657, doi: 10.1007/s11367-017-1355-2.
- Vega-quezada, C., Blanco, M. and Romero, H. (2016), "Synergies between agriculture and bioenergy in Latin American countries : A circular economy strategy for bioenergy production in Ecuador", *New BIOTECHNOLOGY*, Elsevier B.V., pp. 1–9, doi: 10.1016/j.nbt.2016.06.730.
- Yu, R., Cai, J. and Leung, P. S. (2009), "The normalized revealed comparative advantage index", *Annals of Regional Science*, 43(1), pp. 267–282, doi: 10.1007/s00168-008-0213-3.



Impact of Organizational Culture on Employee Satisfaction: A Case of Hilton Hotel, United Kingdom

Christine Reidhead¹

¹ Assistant Professor of Business, Navajo Technical University, USA. Email: creidhead@navajotech.edu

Abstract

Purpose: This paper has focused on examining the impact of organizational culture on employee satisfaction in Hotel Hilton, United Kingdom. **Design:** The paper is written on the basis of secondary data. The research study is conducted on the basis of qualitative research method and data is collected through critical review of literature from secondary sources. The secondary data is collected from scholarly articles and books. **Findings:** From the findings, it is revealed that there is a significant impact of organizational culture on employee satisfaction. When, the management of an organization focuses highly on providing supportive organizational culture, then, it helps in enhancing the satisfaction level of employees. The satisfied employees in an organization serve as a competitive advantage. **Research Limitations:** Due to lack of enough time and resources, the paper is written on the basis of one case study, so, this might decrease the generalizability of research findings. Moreover, future studies can be conducted for examining the importance of organizational culture for other important factors of the firm. **Practical Implications:** The findings of this research paper proves to be much beneficial for managers of organizations, as they can get to know that how satisfaction level of employees can be enhanced through focusing on organizational culture. **Originality:** Previously, there was no study conducted for exploring the importance of organizational culture for enhancing employee satisfaction, and how it could be directly linked to the competitive advantage of the firm. So, this study has been carried out to investigate the impact of organizational culture on employee satisfaction, in the case of Hilton Hotel UK.

Keywords: Organizational Culture, Employee Satisfaction, Hilton Hotel

1. Introduction

In the hospitality industry, human resource plays a key role in ensuring long term survival and success of the firm. Nowadays, it has become highly important to establish that type of organizational culture, with the help of which effective human resource management can be ensured. The establishment of supportive organizational culture has become important, for the purpose of maintaining a good position in the market. It is significant to establish that organizational culture, through which maximum support and continuous improvement can be provided by the firm. The long term growth of an organization depends on the culture of the firm, because this has a significant influence on employee commitment as well as retention in the firm (Arifin, 2015). When there is flexibility in the organization, the work environment will provide employees with a cohesive work place, as well as, independence without feeling any kind of burden. As the business operations of a hotel mainly depend on employees, it is important to provide that culture to employees, in which they can work with full commitment

and dedication (Braithwaite et al, 2017). When employees have a complete understanding of an organizational culture, it ultimately results in improving their performance.

Organizational culture is basically a set of various value systems that can help a firm. With the help of a supportive organizational culture, employees get a better understanding of all key functions of the firm, through sharing key norms and values (Belias et al, 2015). The success of Hotel Hilton, United Kingdom (UK), depends on its effective management of human resource, as a result, becomes a key part in the organizational culture. However, Hilton Hotel is facing a lack of satisfaction among employees, hence, creating a need for exploring and revealing to the employees the importance of organizational culture. Previously, there was no study conducted for exploring the importance of organizational culture for enhancing employee satisfaction, and how it could be directly linked to the competitive advantage of the firm. So, this study has been carried out to investigate the impact of organizational culture on employee satisfaction, in the case of Hilton Hotel UK.

1.1. Research Aim

The aim is to explore the impact of organizational culture on employee satisfaction in the hospitality industry of UK.

1.2. Research Objectives

- To analyze the importance of organizational culture of hotel industry.
- To explore the role-played by employee satisfaction in an organization.
- To understand the influence of organizational culture on employee satisfaction in the hospitality industry.
- To understand how satisfied employees, serve as a source of a competitive advantage.

2. Organizational Culture

Based on the definition provided by Kontoghiorghes (2016), it is stated that, "organizational culture is a combination of values, beliefs, working styles, and associations that differentiate one enterprise from the other." Jung and Yoon (2015) stated that corporate culture in every organization is based mostly on psychological effects that enable researchers to understand how employees in the company think about their organization. It also informs researchers on how organizational culture influences the decisions of employees. Researchers also claim that different levels of organizational culture are centered on the different organizational principles, traditions, practices and past stories. Organizational culture is a set of shared values that allows organizations to understand that employees embrace a similar organizational culture, though, with diverse backgrounds within the organization. Han et al (2015) defined the term "normative glue" as organizational culture, which simply means that organizational culture holds together all the organizational processes. Organizational culture has affected the internal corporate practices and how employees are influenced and engaged towards the values and goals of the organization. It enhances the employees' desire to routinely please the customer repeatedly, therefore, encouraging the customer to return to make more purchases. Guiso et al (2015) states that organizational culture influences different people in different ways, as they think and make decisions consciously and subconsciously, based on what they interpret and feel, and eventually act upon it. According to Balkar (2015), it is possible to maintain and also influence management actions and trusty climate by the instability in the economic system and high individualism. As a result, these actions may inflict a negative impact on the valued work displayed by the employees. If an organizational culture causes issues such as, internal difficulties, the diversified group of that organization is responsible for it.

3. Employee Satisfaction

Job satisfaction seems to be a very interesting subject concerning the organizational behavior of the organization. According to Taneja et al (2015), job satisfaction is an analysis of the assessment level of the individual about how the workplace environment fulfills its demands. The satisfied employees will work for the growth and

advancement of the organization and will put forth every effort to make its organizational culture healthy. Several researchers stated that job satisfaction is essential for employee motivation (Aldridge and Fraser, 2016; McFadden et al, 2015). Some evidence suggests that if workers are satisfied with their job performance, their productivity with the organization becomes greater. Thus, it results in strong employee engagement with the organization. If the personnel have a positive mental attitude toward work, it could be because they are comfortable and satisfied with their work. Hanaysha (2016) in his recent research pointed out that job satisfaction does have a positive effect on employee engagement and is negatively related to employee turnover. According to Dekoulou and Trivellas (2015), job satisfaction is linked through organizational function to the self-actualization needs of employee fulfillment. Several studies show a direct and healthy relationship between customer satisfaction and job satisfaction. Several studies gave different kinds of metrics about this relationship, and Abouraia and Othman (2017) gave the analysis of this positive relationship between job satisfaction and business success. According to Bergheim et al (2015) job satisfaction is a blend of physiological, psychological, and environmental situations through which an individual can confess to being satisfied with the job.

Job satisfaction is an alignment that is quite effective for the part of an individual towards their roles of work. Zumrah and Boyle (2015) - while defining job satisfaction said that job satisfaction is the process through which the employees view their jobs and its various aspects. Employment satisfaction reflects individual behavior, where they do their job. Job satisfaction also indicates commitment and satisfaction of employees with the job. Job satisfaction is a fundamental aspect that determines the direction employees gravitate towards when speaking of appreciation, pay, advancement, and achievement of the goals that satisfy their desires. According to Nie et al (2015) individuals possess different attitudes regarding their job, including the different sorts of jobs that their boss, supervisor, and wages do.

4. Supportive Organizational Culture and Employee Satisfaction

Every organization in the hotel industry has a culture, whether it's deliberately introduced or not. Some organizational cultures seem to be more welcoming than others, and that is an intriguing study that needs answers. Scholars such as Tanwar and Prasad (2016) and Mas-Machuca et al (2016) broadly conceptualized supporting organizational culture as a cohesive set of beliefs, values, expectations, and behaviors among the employees of the organization. Such authors, further described by demonstrating the omnipresence of common beliefs, values, assumptions, and practices as well as the degree to which their members' different values, beliefs, expectations and practices are consistent. Some supporters also claim that the organization continues to benefit from a positive and widespread organizational culture as it fosters engagement, enthusiasm, unity, identity, and uniformity that turn to promote job satisfaction for employees. Hotel culture is mainly based on cognitive systems that explain the way in which workers think and make judgments. Manojlovich and Ketefian (2016) argued that organizational culture is a common set of values and standards expressed within an organization by individuals and groups. For them, the company culture governs how workers communicate with each other and with non-organization stakeholders.

Organizational culture is the importance of structures and expectations that govern the way the company handles its business. This indicates that the values and culture of the company impact profoundly on all those who connected to the organization. It was also clarified that the standards are intangible, but if the company wants to improve employee performance and productivity, then standards must be their first concern to deal with. Contrary to the above evaluation, Chordiya et al (2017) argues that supporting culture may sometimes lead to unconstrained employee demand from the company which can become a hurdle to employee adaptation and transition. Singh et al (2016) further clarifies that positive culture in hotels such as compensation and rewards, opportunities for growth, training, communication and administrative support can often contribute to a change in objectives. Karanika-Murray et al. (2017) claims that the culture of encouragement will move the focus of workers from their organizational goals to their personal growth and benefits. Joo and Lee (2017) further added that if cultural standards and ways of doing things become more important, then the primary purpose of the organization may be overshadowed. Despite the above contrasting evaluation, Sonyand Mekoth (2016) still believe that promoting culture such as rewards and benefits, incentives for contact, supervisory support, and

training and development is a progressive source for employee satisfaction as well as a source of competitive advantage for an organization. However, he argues that each modern culture in organizations should be welcoming and supportive but restricted to certain circumstances. According to Ilyas and Abdullah (2016) job satisfaction is an internally and externally characteristic in which the strong culture of such an organization is focused on the general assessment by an employee of how happy he/she is on the job. Thus, a strong and healthy culture of hotel companies improves self-confidence among its employees and reduces work stress. Tekingündüz et al (2017) believes that effective workplace preparation promotes dedication and strengthens the ethical behavior of the workers within the organization. It is vehemently argued by Singh et al (2016) that if the core value of an organization is not properly defined, conveyed or generally accepted by those working for the company then weak organizational culture may arise. This happens often when there is little harmony between the manner in which things are done and the beliefs inherited. It usually results in poor employee behavior that then results in poor customer experience.

5. Satisfied Employees as Source of Competitive Edge

Hiring the best employees for the Hotel Company does not guarantee success. Nevertheless, recruiting and cultivating competent employees through successful principles of culture such as interaction, encouragement, opportunities for growth and supervisory support will guarantee and give the company a competitive advantage over its rivals. If workers are happy with the organizational culture, they're fulfilled and will certainly support selling the business to outsiders. Islam et al (2015) in his studies acknowledged that the satisfaction of the workforce is defined and influenced by the organizational culture. He added that motivated workers would ensure organizational success by performing wholeheartedly and selflessly giving the company a competitive edge over their rivals. Nazarian et al (2017) thinks that the different forms of communication within the organization as well as the relationship between the employer and the employee have a positive impact on the way in which employees conduct their daily routines at work.

The model of organizational culture assessment established by Nie et al (2015) on employee satisfaction as a key source of competitive advantage measures the relation between organizational structure and job satisfaction. Such two researchers found that workers at various levels of employment are affected by different aspects of work and different dimensions of the work environment. Taneja et al (2015) continued that communication channels and working conditions greatly impact employee satisfaction and send exceptional signal to outside customers. The manner through which the employer treats workers at work can shed a positive effect on the competitive advantage of the organization. Aggrieved and unsatisfied employees do not have time to explain products and services to customers. Losing one single customer per day can cost the company seven customers within one week. Schuster et al (2016) says that employee satisfaction and job performance are linked with organizational culture. He says that culture and job satisfaction are interdependent and seem to have a strong impact on the competitive advantage of the organization. Based on this, Zumrah and Boyle (2015) argue that company management with positive culture can improve employee work efficiency, engagement, and satisfaction. There is a close relationship between organizational culture and job satisfaction. Researchers demonstrate that a strong organization will generate job satisfaction for employees. On the contrary, certain dimensions reflect hostile relations and other positive relationships. Their theory is that the workers perceive cultural values and individuality as contingent for the varied relationships. It should be remembered that not all organizational cultures create competitiveness unless it meets the standards of employees and customers.

Schuster et al (2016) argued that if workers are well content with the culture of the organization, they will be motivated to work tirelessly to boost the business performance over their rivals. From their perspective, the duties of the employee are clear, which would inevitably boost the organizational performance level. Mas-Machuca et al (2016) reported in their research that each positive organizational culture will increase employee satisfaction and will lower organizational turnover ratio. Although, all companies have a culture but any company that does not incorporate encouraging and compensatory cultural traits, such as, incentives for professional development, training and supervisory support, their workers are not as engaged in a well-mannered way. The effects of alienated and unengaged workers will adversely affect the competitive advantage of the company. This is because disgruntled workers wouldn't necessarily do their best to see the company get ahead

and surpass their rivals. Employees satisfied with the organizational culture will affect the willingness of other employees to provide professional services which reflects superior management support.

6. Conclusion

In the end, it is the organizational culture that is considered highly important for organizations in the hospitality and hotel industry, for employees to perform and excel at a higher standard than the average organization when speaking of employee performance and commitment level. When employees have a complete understanding about the culture of a firm, they feel satisfied with their job. Employee satisfaction is the emotional capacity linked with both, positive, as well as, negative elements, to every job experience. An employee shows high levels of commitment, when the organizational culture fully supports him or her, and, also results in increasing the chance of fulfilling organizational goals. With the continuous willingness of commitment from the employees, it strengthens their employment outlook with the organization. There is a significant impact on employee satisfaction and the employees' intention of whether to leave or stay in the organization when the determining factor is the organization's culture.

References

- Abouraiia, M.K. and Othman, S.M., 2017. Transformational leadership, job satisfaction, organizational commitment, and turnover intentions: the direct effects among bank representatives. *American Journal of Industrial and Business Management*, 7(4), pp.404-423.
- Aldridge, J.M. and Fraser, B.J., 2016. Teachers' views of their school climate and its relationship with teacher self-efficacy and job satisfaction. *Learning Environments Research*, 19(2), pp.291-307.
- Arifin, H.M., 2015. The Influence of Competence, Motivation, and Organisational Culture to High School Teacher Job Satisfaction and Performance. *International Education Studies*, 8(1), pp.38-45.
- Balkar, B., 2015. Defining an empowering school culture (ESC): Teacher perceptions. *Issues in Educational Research*, 25(3), p.205.
- Bergheim, K., Nielsen, M.B., Mearns, K. and Eid, J., 2015. The relationship between psychological capital, job satisfaction, and safety perceptions in the maritime industry. *Safety science*, 74, pp.27-36.
- Braithwaite, J., Herkes, J., Ludlow, K., Testa, L. and Lamprell, G., 2017. Association between organisational and workplace cultures, and patient outcomes: systematic review. *BMJ open*, 7(11), p.e017708.
- Belias, D., Koustelios, A., Vairaktarakis, G. and Sdrolias, L., 2015. Organizational culture and job satisfaction of Greek banking institutions. *Procedia-Social and Behavioral Sciences*, 175(1), pp.314-323.
- Chordiya, R., Sabharwal, M. and Goodman, D., 2017. Affective organizational commitment and job satisfaction: A cross-national comparative study. *Public Administration*, 95(1), pp.178-195.
- Dekoulou, P. and Trivellas, P., 2015. Measuring the impact of learning organization on job satisfaction and individual performance in Greek advertising sector. *Procedia-Social and Behavioral Sciences*, 175(4), pp.367-375.
- Guiso, L., Sapienza, P. and Zingales, L., 2015. The value of corporate culture. *Journal of Financial Economics*, 117(1), pp.60-76.
- Hanaysha, J., 2016. Testing the effects of employee engagement, work environment, and organizational learning on organizational commitment. *Procedia-Social and Behavioral Sciences*, 229(8), pp.289-297.
- Han, K., Trinkoff, A.M. and Gurses, A.P., 2015. Work-related factors, job satisfaction and intent to leave the current job among United States nurses. *Journal of clinical nursing*, 24(21-22), pp.3224-3232.
- Ilyas, M. and Abdullah, T., 2016. The Effect of Leadership, Organizational Culture, Emotional Intelligence, and Job Satisfaction on Performance. *International Journal of Evaluation and Research in Education*, 5(2), pp.158-164.
- Islam, T., Ahmed, I. and Ahmad, U.N.B.U., 2015. The influence of organizational learning culture and perceived organizational support on employees' affective commitment and turnover intention. *Nankai Business Review International*.
- Jung, H.S. and Yoon, H.H., 2015. The impact of employees' positive psychological capital on job satisfaction and organizational citizenship behaviors in the hotel. *International Journal of Contemporary Hospitality Management*.
- Joo, B.K. and Lee, I., 2017, August. Workplace happiness: work engagement, career satisfaction, and subjective well-being. In *Evidence-based HRM: A Global Forum for Empirical Scholarship*. Emerald Publishing Limited.

- Karanika-Murray, M., Duncan, N., Pontes, H.M. and Griffiths, M.D., 2015. Organizational identification, work engagement, and job satisfaction. *Journal of Managerial Psychology*.
- Kontoghiorghes, C., 2016. Linking high performance organizational culture and talent management: satisfaction/motivation and organizational commitment as mediators. *The International Journal of Human Resource Management*, 27(16), pp.1833-1853
- Mas-Machuca, M., Berbegal-Mirabent, J. and Alegre, I., 2016. Work-life balance and its relationship with organizational pride and job satisfaction. *Journal of Managerial Psychology*.
- Manojlovich, M. and Ketefian, S., 2016. The effects of organizational culture on nursing professionalism: Implications for health resource planning. *Canadian Journal of Nursing Research Archive*, 33(4).
- McFadden, P., Campbell, A. and Taylor, B., 2015. Resilience and burnout in child protection social work: Individual and organisational themes from a systematic literature review. *The British Journal of Social Work*, 45(5), pp.1546-1563.
- Nazarian, A., Atkinson, P. and Foroudi, P., 2017. Influence of national culture and balanced organizational culture on the hotel industry's performance. *International Journal of Hospitality Management*, 63, pp.22-32.
- Nie, Y., Chua, B.L., Yeung, A.S., Ryan, R.M. and Chan, W.Y., 2015. The importance of autonomy support and the mediating role of work motivation for well-being: Testing self-determination theory in a Chinese work organisation. *International Journal of Psychology*, 50(4), pp.245-255.
- Singh, S.K., Burgess, T.F., Heap, J. and Al Mehrzi, N., 2016. Competing through employee engagement: a proposed framework. *International Journal of Productivity and Performance Management*.
- Sony, M. and Mekoth, N., 2016. The relationship between emotional intelligence, frontline employee adaptability, job satisfaction and job performance. *Journal of Retailing and Consumer Services*, 30, pp.20-32.
- Schuster, T., Lund-Thomsen, P., Kazmi, B.A., Sharma, N. and Singh, V.K., 2016. Effect of workplace incivility on job satisfaction and turnover intentions in India. *South Asian Journal of Global Business Research*.
- Tanwar, K. and Prasad, A., 2016. The effect of employer brand dimensions on job satisfaction: gender as a moderator. *Management Decision*.
- Tekingündüz, S., Top, M., Tengilimoğlu, D. and Karabulut, E., 2017. Effect of organisational trust, job satisfaction, individual variables on the organisational commitment in healthcare services. *Total Quality Management & Business Excellence*, 28(5-6), pp.522-541.
- Taneja, S., Sewell, S.S. and Odom, R.Y., 2015. A culture of employee engagement: A strategic perspective for global managers. *Journal of Business Strategy*.
- Zumrah, A.R. and Boyle, S., 2015. The effects of perceived organizational support and job satisfaction on transfer of training. *Personnel Review*, 44(2), pp.236-254.



Non-Linear Effect of Government Spending on Private Consumption in Cambodia: Markov-Switching Autoregressive Model

Leanghak Hok^{1,2}

¹ Institute of Economic Theory and Methodology, University of Miskolc, Miskolc 3515, Hungary

² Department of Agricultural Economics, Prek Leap National Institute of Agriculture, Phnom Penh 12112, Cambodia

Correspondence: Email: gethok@uni-miskolc.hu or leanghak.hok@gmail.com

Abstract

The influence of government expenditure on private consumption has been debated among scholars. Some studies have found a positive linkage between the two while some others have found a negative one. In this study, the Markov-Switching Autoregressive (MSAR) model was used to investigate the non-linear impact of government spending on private consumption in Cambodia. The result based on Cambodia's annual data from 1987 to 2015 shows that private consumption responds positively to a rise in disposable income or a decline in saving interest rates. Inflation is statistically insignificant. The impact of government purchases on private consumption is linear, negative, and asymmetric. A non-linear effect of government investment on household consumption occurs in Cambodia during certain periods—times of political instability, which are 1994-1995, 1997-1998, and 2004-2006. This non-Keynesian effect during the period 2010-2015 occurs because of raising the present value of taxes. The contribution of the study is that an increase in the present value of taxes and political instability can prevent the efficacy of government spending on private consumption.

Keywords: Private Consumption, Government Investment, Government Consumption, Markov-Switching Autoregressive Model, Cambodia

JEL classification: C80, E62, G28, H50

1 Introduction

Scholars have debated fiscal policy's multiplier effect (i.e., a change in output with some value of multiplication in response to an increase or a decline in government spending (Jahan, Mahmud, and Papageorgious, 2014)) over a lengthy period. Keynesian theory with its assumptions of rigid wages and prices and initially underemployed economic resources predicts that a drop in government expenditure spoils private demand (private consumption) and output via the multiplier effect. There are two types of government spending (i.e., public investment and consumption). Government consumption produces a different multiplier effect from public investment (Boehm, 2019). The government purchases multiplier is lower than the government investment multiplier (Baxter & King,

1993). Under four assumptions (i.e., sticky nominal wage, monopolistic competition, the existence of rational expectation for firms with profit maximization and for households with utility maximization, and a change in the nominal interest rate in short-run), the New-Keynesian theory points out that the expansion of government spending diminishes the consumption multiplier (i.e., the reaction of household consumption to an increase in aggregate demand) due to higher interest rates. The countercyclical fiscal policy used rigorously over the last decade has aroused researchers' curiosity about the impact of government expenditure on economic activities (Jha et al., 2014). In the context of accumulated public debt, there are weakening commodity prices, slowing global economic growth, and improving global interest rates during a period, so a sustainable drop in government spending, especially government purchasing seems to be demanded (Dawood & Francois, 2018). Some empirical studies explore the linkage between government spending and private consumption. Bailey (1971) highlighted a notable signal that a degree of substitutability between private consumption and government expenditure, especially government consumption, probably takes place. Thus, an increase in government expenditure crowds out private consumption. Aschauer (1985) used a permanent-income approach and showed that private consumption on nondurables and services declines in the range of 23 to 42 percent in response to a rise in government expenditure in the United States of America (USA). Notably, his finding is entirely consistent with the research conducted by Kormendi (1983). Ahmed (1986) used a simple intertemporal substitution model and found that this negative influence exists in the United Kingdom (UK). Amano and Wirjanto (1997) employed a two-good permanent-income model and relative price approach and indicated that the USA's intratemporal substitution (i.e., the intraperiod elasticity of substitution) between government spending and private consumption is approximately 0.9, which suggests that private expenditure responds negatively to the expansion of government spending measured by government purchases. Their result corresponds with the outcome estimated by conducted by Ho (2001), who used the panel Dynamic Ordinary Least Square (DOLS) approach to determine the sum of public investment and government consumption to measure government spending.

Other empirical studies provide the opposite results. Ambler, Bouakez, and Cardia (2017) study's conclusion, based on the vector autoregressions (VARs) approach, indicated that an elevated level of private consumption and real wages is the reaction to the expansion of public investment. Government purchases are complementary to private expenditures. Bouakez and Rebei (2007) applied the Maximum-likelihood (ML) method to USA data and found that a strong complementarity effect (Edgeworth complements) exists, where private consumption improves in response to an increase in government consumption. Karras (1994) followed Hall's random walk model (i.e., maximum consumption following a random walk) and suggested that a degree of complementarity between government expenditure and private consumption exists in the observed countries and varies among those countries. This complementarity degree diminishes when the value of government spending is more substantial. Giavazzi and Pagano (1990) and Amano and Wirjanto (1998) impose the nonlinear effect (i.e., the occurrence of both Keynesian and non-Keynesian impact in a certain period) of government expenditure on private consumption. The government spending follows the traditional Keynesian theory during usual times, but a firm contradictory fiscal policy provoked by a high level of debt leads to the existence of a non-Keynesian effect (Giavazzi & Pagano, 1990). Based on the Markov regime-switching model, Wang and Gao (2011) found that the impact of government investment on private consumption is linear and positive, but not symmetrical. The government purchases non-linearly influence private consumption. This non-linear impact of the fiscal policy in China is not associated with the initial fiscal status or the magnitude of fiscal consolidation. Alesina and Ardagna (1998)'s outcome, anchored in a probit model run on panel data of OECD countries, reflected that the effect of fiscal policy on private consumption is non-linear. Two main factors (magnitude and structure of fiscal adjustment) cause the occurrence of this non-linearity.

Household final consumption (private consumption) contributed significantly to aggregate demand in Cambodia as a lower middle-income country and ranged between 73 and 85 percent of GDP over a period from 2000 to 2015. Complex fiscal challenge is thought to have originated in Cambodia. In the early 2010s, Cambodia's government seemingly adopted a countercyclical fiscal policy. Notably, Cambodia's government consumption as a share of GDP progressively declined from 6.34 percent in 2010 to 5.39 percent in 2015. Public investment as a share of GDP also dropped from 8.20 percent to 5.30 percent, while the tax revenues in the same period continuously and sharply increased from 7.3 percent to 14.6 percent of GDP. This countercyclical fiscal policy can become a concern if this policy prevents the stimulation of Cambodia's private demand, especially household consumption, and the

progress of economic development. Therefore, it is necessary to advance the understanding of the effect of fiscal policy on private consumption in Cambodia.

As empirical studies mentioned above found, there is no consistency in the impact of fiscal policy on private consumption due to the variety of variables taken into account, the different countries investigated over different time intervals, and different methodologies. However, this paper intends to examine the nonlinear effect of government spending (i.e., government investment and purchases) on private consumption in one context, that of Cambodia. The study can provide a reference to other researchers interested in non-linearity and can inform Cambodia's policymakers about the characteristics, which cause the existence of a non-linear effect on private consumption in Cambodia's economy.

This paper is arranged as follows. Section 2 describes the methodology (e.g., specific model, data collection, and method). Section 3 shows the results with interpretation and discussion. Section 4 offers conclusions and policy implications.

2 Methodology

2.1 Specific model

Government spending can be divided into government consumption and investment. Barro (1981) introduced government consumption into the general model and investigated the consumption utility directly responds to a change in government purchases. Extensive research (seen in studies of Ahmed (1986), Karras (1994), Devereux, Head, and Lapham (1996), Giavazzi and Pagano (1996), and Giavazzi and Pagano (1996)) has demonstrated that government purchases play a direct role in influencing private consumption even though results vary regarding the relationship between them. Some empirical research undertaken by Wang and Gao (2011) and Ambler, Bouakez, and Cardia (2017) suggests that public investment also becomes involved in the elasticity of private consumption via fluctuation in real wages.

The disposable income is not taken into account, thereby lessening the robustness of the linkage between government expenditure and private consumption (Graham, 1993). Ho (2001), Wang and Gao (2011), and Varlamova and Larionova (2015) indicate that disposable income plays a vital role in the elasticity of private consumption because the improvement of households' capability reacts to an increase in disposable income.

Based on the basic concept, the disposable income of households equals the sum of consumption and saving. Under budget constraint (no change of disposable income), a higher interest rate on savings produces more disincentive to households to make expenditures. According to new-Keynesian theory, an alternative explanation is that households usually participate in the credit market to smooth their future expenditure. The growth of interest rates leads to households to reduce the current consumption and to keep their money for spending in the future. A change in interest rates, therefore, affects household behavior towards consumption.

The fluctuation of inflation (i.e., a change in the price of commodities on a day-to-day basis) influences the cost of living and the capacity for household consumption. Some empirical studies carried out by Varlamova and Larionova (2015) and Sulekha, Mary, and Tharmalingam (2019) also indicate the existence of the connection between inflation and private consumption.

In this study, public investment and consumption, disposable income, interest rates, and inflation are taken into account. Thus, the regression model of private consumption can be written as follows:

$$CC_t = \beta_{0s} + \alpha_1 DIS_t + \alpha_2 RATE_t + \alpha_3 INF_t + \beta_{1s} GI_t + \beta_{2s} GC_t + \varepsilon_t, \quad (1)$$

where $t = 1987, 1988, \dots, 2015$

CC_t stands for private consumption as a share of GDP of Cambodia at the time t ;

DIS_t is disposable income as a share of GDP of Cambodia at the time t ;

$RATE_t$ refers to saving interest rate of Cambodia at the time t ;

INF_t represents inflation of Cambodia at the time t ;

GI_t denotes government investment as a share of GDP of Cambodia at the time t ;

GC_t stands for government consumption as a share of GDP of Cambodia at the time t ;

ε_t is residual at the time t .

2.2 Data Collection

Gross fixed investment as a percent of GDP can be a substitution for interest rates on savings (as seen in the studies of Solow (1956, 1957), Phelps (1961), Mankiw, Romer, and Weil (1992), and Hajamini and Falahi (2018)). To avoid multicollinearity between public investment and gross fixed investment, private investment as a share of GDP serves as a proxy for the interest rate on savings. Cambodian data from 1987 to 2015 equals 29 observations. Variables collected for this analysis are:

- Household final consumption expenditure (private consumption) as a share of GDP: consumption of goods and services made by resident households;
- Government final consumption expenditure (government purchases) as a share of GDP: general government consumes goods and services and spends on collective consumption services;
- Gross domestic product (GDP) at constant price 2011: total value of goods and services produced during a year;
- Government fixed capital formation (public investment) at constant price 2011: gross fixed capital formation only provided by central and subnational governments;
- Gross national saving as a percentage of GDP: the sum of savings from individuals, businesses, and government;
- Private investment at constant price 2011: infrastructure services delivered by private sectors;
- Inflation: rate of change in the general price level of goods and services sold in the country.

The three principal sources report the data of variables mentioned above:

- The United Nations Statistics Division's National Accounts Main Aggregates Database. The data of household final consumption expenditure as a share of GDP and government final consumption expenditure as a share of GDP are retrieved from the link:
<https://unstats.un.org/unsd/snaama/dnlList.asp>
- The International Monetary Fund's (IMF) World Economic Outlook 2017 database. The link to access the data of gross national saving as a share of GDP and inflation is:
<http://www.imf.org/external/pubs/ft/weo/2017/02/weodata/index.aspx>
- The Investment and Capital Stock Dataset of the IMF offers the data of the rest of the variables via the link:
<https://www.imf.org/external/np/fad/publicinvestment/>

The transformation made to obtain the independent variables for this regression can be explained as follows:

- Disposable income as a share of GDP is the sum of household final consumption expenditure as a share of GDP and gross national savings as a share of GDP,
- Government investment at a constant price 2011 and private investment at a constant price 2011 divided by GDP at a constant price 2011 is government investment as a share of GDP and private investment as a share of GDP, respectively.

The data analysis is performed in STATA 15.1.

2.3 Markov-switching autoregressive model

Identifying and defining potential periods of the nonlinear impact of fiscal adjustment becomes a sensitive issue in testing the non-linear relationship between fiscal policy and private consumption. Based on the empirical studies in this area, researchers usually adopt two methods. In the case of the first method, the possible periods of the nonlinear effect of fiscal adjustment are pinpointed exogenously. Some empirical studies typically use various indicators as the identification of the potential periods. Cour et al. (1996) and McDermott and Wescott (1996) consider the primary structural balance to be one of the indicators, that causes trouble with inflation and real interest rates. The second indicator is the adjustment of government debt or purchases as a percent of GDP (Bertola & Drazen, 1993; Perotti, 1999). Distinctive indicators produce different definitions of time length for expansionary or contractionary fiscal policy. A year in length is used for the fiscal policy adjustment in the study of Alesina and Ardagna (1998). To reduce the possible occurrence of fiscal adjustment lasting a year, Giavazzi and Pagano (1996) impose some stringent conditions that refer to dummy variables of the cumulative change in structural deficit (see their study for more details). The methods of exogenous identification of the potential period of nonlinear fiscal effects are seemingly no different but generate disparate empirical outcomes. Based on the study of Kamps (2001) of 14 European countries, the significant level of this nonlinearity sensitively relies on the definitions of time length for nonlinear fiscal effects. The endogenous identification of possible periods of nonlinear fiscal impact is another method that does not limit the number of this nonlinearity's potential periods, which are estimated based on the real dataset (Höppner and Wesche, 2000; Wang and Gao, 2011).

The method of exogenous identification can generate an excessive number of possible periods of nonlinearity or miss fiscal adjustment periods of less than a year in length. Thus, this study adopts the Markov-switching autoregressive (MSAR) model (see Hamilton (1989) and Chang, Choi, and Park (2017)) as the method of identifying the potential periods of nonlinear fiscal effects endogenously. The MSAR model refers to a discrete-time process, which depends on two components, such as dynamics of the observed process (i.e., dependent variable's process) and hidden process (i.e., finite-state or finite-regime Markov chain). The MSAR model is also conditional upon autoregressions and classifies sample observations into a small number of homogenous groups, so-called regimes. The Markov regime-switching model with AR improves the accuracy of estimated transition probabilities and the effectiveness of parameter estimates.

In our model, we do not deal with systematic errors due to tag time series. The measurement errors can be recorded from two components (i.e., random and systematic error). We had no technical information to qualify the systematic error, so it was assumed to be null. The MSAR model in our study is a homogenous hidden Markov chain and autoregressive model. AR term in this MSAR model becomes an AR(p) process of residual time series. p denotes the number of AR. Based on the literature, scholars argue that two effects (negative or positive) of government spending on private consumption may exist in a certain period. Wang and Gao (2011) used two regimes (i.e., $s_t = 1$ and $s_t = 2$) of the Markov regime-switching model and estimated with annual data and time interval from 1978 to 2008. Thus, we propose two regimes and assume the errors to be homogenous across the regime in our analysis. The optimal lags selected by BIC (Bayesian Information Criterion developed by Schwarz (1978)) are one ($p = 1$). This study only uses the first level of AR. Therefore, equation (1) can be rewritten under the MSAR model with the first level of AR:

$$CC_t = \beta_{0s_t} + \alpha_1 DIS_t + \alpha_2 RATE_t + \alpha_3 INF_t + \beta_{1s_t} GI_t + \beta_{2s_t} GC_t + \phi_{1s_t} (CC_{t-1} - \beta_{0s_{t-1}} - \alpha_1 DIS_{t-1} - \alpha_2 RATE_{t-1} - \alpha_3 INF_{t-1} - \beta_{1s_{t-1}} GI_{t-1} - \beta_{2s_{t-1}} GC_{t-1}) + \varepsilon_t, \quad (2)$$

where β_{0s_t} , β_{1s_t} , and β_{2s_t} are the parameters with characteristics of regime-switching or state-dependence. α_1 , α_2 , and α_3 assume no change with states (regimes) and are included in the regression model to increase the number of degrees of freedom. ϕ_{1s_t} refers to a coefficient of the first AR term. ε_t is residual (random error) with zero mean and state-dependent variance $iid(0, \sigma^2)$.

3 Results and Discussion

3.1 Estimation

It is strictly necessary to identify the natural data trend before executing the time series analysis. The unit-root test demonstrates that the time series of data consists of a deterministic trend (stationary data in order zero) or stochastic trend (stationary data in order one) (Kirchgässner, Wolters, and Hassler, 2013). The Augmented Dickey-Fuller (ADF) test (Dickey & Fuller, 1979), like the famous unit-root test, is based on differencing to transform non-stationarity to stationarity. However, the ADF test heavily depends on lag length, so choosing the optimal time lag is subject to minimizing the value of Bayesian Information Criterion (BIC) proposed by Schwarz (1978). The null hypothesis of this test suggests a unit root or non-stationarity. The result of the unit-root test reported in Table 1 indicates that explained and explanatory variables are stationary at order zero $I(0)$. Exceptionally, a predictor ($RATE$) is stationary at first order $I(1)$.

Table 1: Unit root test

Test	Augmented Dickey-Fuller (ADF)	
	X_i	ΔX_i
<i>CC</i>	-2.264**	
<i>DIS</i>	-2.358**	
<i>RATE</i>	-1.208	-3.473***
<i>INF</i>	-1.871**	
<i>GI</i>	-1.671*	
<i>GC</i>	-3.691 ***	

Note: Δ is the first difference. *, **, and *** represent the significance level at 10, 5, and 1 percent, respectively.

Table 2: Results of Markov-switching Autoregressive model

CC_t	Coefficient	Standard Error	T-statistic
α_1	0.243***	0.025	9.59
α_2	-1.944***	0.090	-21.43
α_3	0.009	0.006	1.33
AR(1)	-0.844***	0.111	-7.55
Regime 1			
$\beta_{1s}(s_t = 1)$	0.319**	0.144	2.21
$\beta_{2s}(s_t = 1)$	-1.461***	0.123	-11.87
$\beta_{0s}(s_t = 1)$	81.901***	2.451	33.41
Regime 2			
$\beta_{1s}(s_t = 2)$	-1.735***	0.130	-13.31
$\beta_{2s}(s_t = 2)$	-2.020***	0.148	-13.56
$\beta_{0s}(s_t = 2)$	97.477***	3.482	27.99
Log-likelihood	-53.081		
sigma	0.988		

Note: *, ** and *** indicate the significance level at 10, 5, and 1 percent, respectively.

Table 2 reveals the results of the Markov-switching autoregressive (MSAR) model subject to gradient-based optimization. The value of log-likelihood equals -53.081. All of the predictors with the exception of inflation are statistically significant at the 5 percent level. Disposable income has a positive impact on private consumption because an increase in disposable income improves the household capacity to consume. A higher saving interest rate reduces private consumption. From a fundamental perspective, household saving and expenditure are substitution goods subject to no change in disposable income. Thus, a rise in the interest rate on savings encourages households to save rather than to make expenditures. There is a linear effect of government purchases on private consumption because the result in both regimes provides the same negative sign but different values of the coefficients ($\beta_{2s}(s_t = 1) = -1.461$ and $\beta_{2s}(s_t = 2) = -2.020$). The extension of government purchasing crowds out private consumption--that is, public consumption is a substitute for household expenditure in Cambodia. In the case of government investment, there is a different sign of coefficient in regime 1 ($\beta_{1s}(s_t = 1) = 0.319$) and regime 2 ($\beta_{1s}(s_t = 2) = -1.735$). This result indicates that a non-linear effect of government investment on private investment exists in the Cambodian economy. The main reasons for the occurrence of this nonlinearity can be explained in the part of identifying non-Keynesian years and discussion. The coefficient of AR(1) is statistically significant at 5 percent level and means that residual at the time t depends on its first lag.

Table 3: Regime-switching probability matrix

	i	Regime 1	Regime 2
j			
Regime 1		0.5819	0.4180
Regime 2		0.3645	0.6354

Note: i and j represent a different regime.

The estimated results of the regime-switching probability matrix presented in Table 3 offer a valuable clue to identify the average duration for the existence of the same regime. The calculation of average duration follows the formula:

$$D(s) = \frac{1}{1 - p_{ii}}, \quad (3)$$

where $D(s)$ stands for the average duration of the regime (state), and p_{ii} denotes regime-switching probability.

Table 4: Estimation of duration in each regime

	Sample size	Frequency	Average duration
Regime 1	12	0.429	2.391
Regime 2	16	0.571	2.742

Table 4 reports frequency and average duration for the two regimes: 57.1 percent of the total sample belongs to the regime with non-Keynesian impacts, but the rest of this sample comprises 12 observations in the regime with Keynesian effects. The average duration is 2.391 years for Keynesian impacts and 2.742 years for non-Keynesian effects.

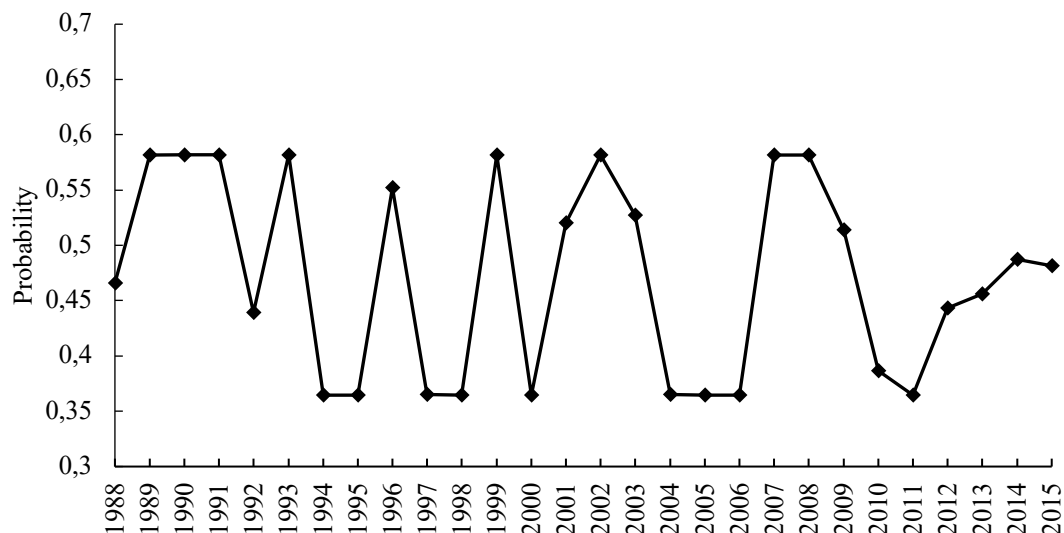

Figure 1: Smooth switching probability of Keynesian effect regime, 1988-2015

Source: Author's estimation

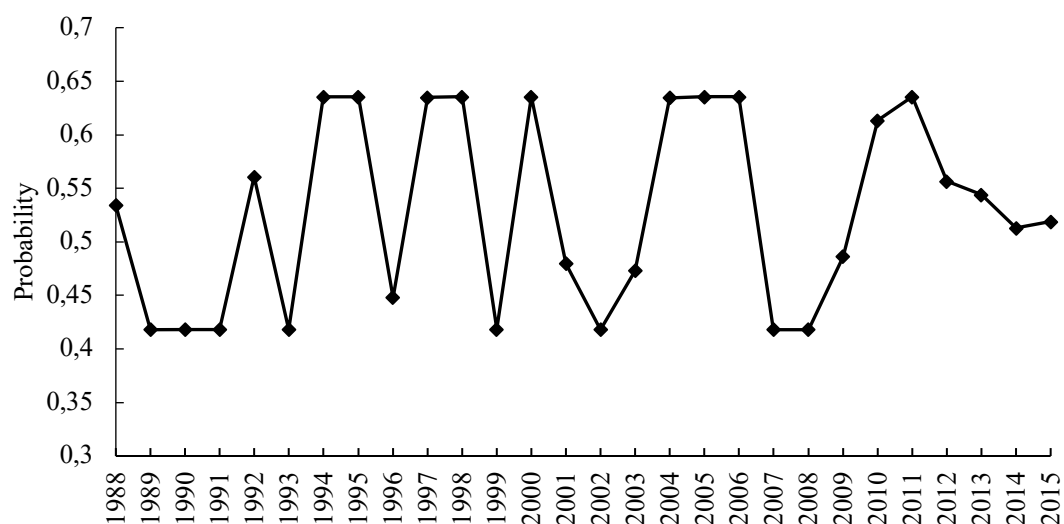

Figure 2: Smooth switching probability of Non-Keynesian effect regime, 1988-2015

Source: Author's estimation

Figures 1 and 2 show that some years and periods, with the probability of Keynesian impacts more than 0.5 or close to 1 and the probability of non-Keynesian effects less than 0.5 or close to 0, lead to the existence of the Keynesian effects. However, some years and periods in the time interval of this study have the probability of non-Keynesian impacts higher than 0.5 and Keynesian effects' probability lower than 0.5, thus generating the occurrence of non-Keynesian effects for those years and periods. As a result, there is a non-linear influence of fiscal policy, mainly public investment, on private consumption in Cambodia's economy.

Table 5: Identification of regimes

	Years	Probability
Non-Keynesian regime	1988	0.5342
	1992	0.5608
	1994-1995	0.6354
	1997-1998	0.6351
	2000	0.6354
	2004-2006	0.6351
	2010-2015	0.5635
Keynesian regime	1989-1991	0.5819
	1993	0.5819
	1996	0.5519
	1999	0.5816
	2001-2003	0.5430
	2007-2009	0.5592

Source: Author's estimation

The precise identification of regimes shown in Table 5 illustrates in which periods Keynesian or non-Keynesian effects of government spending exist. The existence of the Keynesian effects in the 1989-1991, 2001-2003, and 2007-2009 periods indicates that expansionary fiscal policy enhances private consumption. However, the 1994-1995, 1997-1998, and 2004-2006 periods have non-Keynesian effects, probably because political instability discourages households from increasing their expenditures. During 1994-1995, Cambodia faced political uncertainty because the Cambodia People's Party (CPP) leaders intended to refuse to accept the election outcome. The disagreement about the national election 1993's result spun out political turmoil and led to a political impasse during 1994-1995. Before the national election of 1998 came, a political stalemate had seemingly started to increase since March 1997. After the national election in 2003, Cambodia reached political deadlock because it was unable to form the new government until July 2004. The non-Keynesian impact of government expenditure also occurs during 2010-2015 because Cambodia's government seemingly used countercyclical fiscal policy at that period. According to the ADB database, the tax revenues as a share of GDP progressively and dramatically grew from 7.3 percent in 2010 to 14.6 percent in 2015. Increasing the present value of taxes contributes negatively to the private wealth effect (i.e., a change in household consumption based on asset value via price level, disposable income, and interest rates) because a higher present value of taxes can increase the price of goods and services in the market and decrease disposable income, thereby harming household spending.

3.2 Discussion

The result of this study, which highlights the nonlinear effect of government spending on private consumption, agrees with the outcomes of Giavazzi and Pagano (1990), Blanchard (1990), Alesina and Ardagna (1998), Perotti (1999), Höppner and Wesche (2000), Aarle and Garretsen (2003), and Wang and Gao (2011). However, various reasons are raised to point out the emergence of the non-Keynesian effect of government expenditure on private consumption. This study emphasizes two main reasons – political instability and increasing the present value of taxes – which causes a negative influence on the wealth effect through inflation and a reduction in disposable income. Giavazzi and Pagano (1990) spotlight the substitution between public and private consumption because government consumption, which seems to be a waste of resources, does not offer consumers any utility. They raised an example of the Danish government in 1983-84—that is, Danish private consumption increases in response to contractionary government consumption. Also, agent (household) expectations about the future policy cause the existence of non-Keynesian effects. Based on perfect knowledge and rational expectation, households cut down their expenditures in response to the extension of government expenditure because they anticipate that the government will raise the present value of taxes to finance its spending and intends to balance its budget. In term of fiscal consolidation, Ho (2001) suggests that issuing government bonds to finance its own expenditure leads to speed up increases in the interest rates, thereby slowing down household consumption as well as other components of aggregate demand. In another case, the initial value of government spending above a threshold

level (optimal value) triggers the non-Keynesian effects – that is, the positive or negative influence of government expenditure relies on the magnitude of that expenditure (Bertola & Drazen, 1993). Wang and Gao (2011) propose personal characteristics (i.e., a quota restriction plan for commodities, minimum employment programmes and like this) of commodities and labor market as an important reason leading to the existence of non-linear effects in China's economy. It is possible to demonstrate conclusively that the structure and magnitude of government expenditure, agent expectations, characteristics of commodities and labor market, and environment change (political instability) contribute to the occurrence of the non-linear effect of government spending on private consumption.

Most studies found that non-linearity exists on government purchases (seen in Cour et al., (1996), Perotti (1999), Aarle and Garretsen (2003), and Wang and Gao (2011)). On the other hand, the outcome of this study indicates that public investment has a non-linear effect on private consumption. This study provides insight into the non-linear effect, which can occur in government investment as well.

4 Conclusions and policy implications

4.1 Conclusions

The debate about the effectiveness of public policy has been taking place since the global crisis in 2008. The government spending in this study is divided into two types (government consumption and investment) and analyzed separately in the model. The Markov-switching Autoregressive (MSAR) model is used to estimate the non-linear impact of government expenditure on private consumption in Cambodia in the time interval from 1987 to 2015. The result indicates that non-linearity exists on Cambodia's public policy, mainly public investment. Political instability leads to the existence of the non-Keynesian effect during those periods (i.e., 1994-1995, 1997-1998, and 2004-2006). Also, the non-Keynesian impact reacts to raising the present value of taxes in the period 2010-2015. However, the linear and asymmetric effect occurs in public consumption, and government purchases are substitutes for private consumption. Private consumption negatively reacts to a decrease in disposable income and an increase in saving interest rate while inflation is statistically insignificant. The outcomes of this study provide a fascinating insight into the existence of the non-linear effect of fiscal policy (government spending) on private consumption. The two primary reasons (political instability and putting up the present value of taxes) contribute to the occurrence of the non-linear impact of government expenditure and private consumption.

4.2 Limitation

There are limited data. This study cannot cover all variables which influence private consumption. Notably, tax revenues and income distribution suggested by Wang and Gao (2011) are not included in the regression model because the data are limited or unavailable. The disposable income is calculated based on the sum of household final consumption expenditure and gross national saving, which takes into account government saving. This computation, therefore, can produce calculated disposable income above the actual value of household disposable income. The limited data of interest rate leads to the usage of private investment as a share of GDP to be a proxy of saving interest rates. The sample period with 28 annual observations used in the MSAR estimation is small, any empirical inference is a challenge, and results will likely be fragile.

4.3 Policy implications

Since 2010, insufficient productive private consumption (household consumption) for economic growth has occurred in Cambodia's economy because household final consumption expenditure as a share of GDP dropped from 81.29 percent in 2010 to 76.80 percent in 2015. This study of the non-linear effect of government spending on private consumption can offer a reference point for Cambodia's government, which controls macro policy and advances the efficacy of fiscal policy under changing economic circumstances. The investigated non-linearity proposes a new perception to evaluate the efficacy of government expenditure. The Cambodian government has pursued a policy of raising the present value of taxes during the period 2010-2015, thereby influencing households through negative wealth effect and the existence of the non-linear effect of government expenditure on private consumption. Political instability during the 1990s can reduce the efficiency of government investment to private consumption in Cambodia. It negatively affects household behavior on their expenditures because they intend to

keep money on their hand rather than to make expenditures. The government should ascertain the circumstances which produce the Keynesian and non-Keynesian impact of government expenditure, mainly public investment, and thus take proper action to promote private consumption effectively. The integration of fiscal and monetary policy may be a better idea to enhance private consumption undoubtedly because households very often get involved in the financial market to smooth their spending. In the case of the improvement of private consumption, government purchases should be reduced because there is a substitution between public and private consumption.

Acknowledgments

The author would like to thank Dr. Zoltán Bartha, whose advice improved this research, and the Hungarian government for its financial support (through its Stipendium Hungaricum Scholarship) for doctoral studies at the University of Miskolc.

Funding

The described article or study was carried out as a part of the [EFOP-3.6.1-16-2016-00011] “Younger and Renewing University – Innovative Knowledge City – institutional development of the University of Miskolc aiming at intelligent specialization” project implemented in the framework of the Szechenyi 2020 program. The realization of this project is supported by the European Union, co-financed by the European Social Fund.

Conflicts of interest

The author has no conflict of interest.

References

- Aarle, B. Van, & Garretsen, H. (2003). Keynesian, non-Keynesian or no effects of fiscal policy changes? The EMU case. *Journal of Macroeconomics*, 25, 213–240. [https://doi.org/10.1016/S0164-0704\(03\)00026-0](https://doi.org/10.1016/S0164-0704(03)00026-0)
- Ahmed, S. (1986). Temporary and permanent government spending in an open economy: Some evidence for the United Kingdom. *Journal of Monetary Economics*, 17(2), 197–224. [https://doi.org/10.1016/0304-3932\(86\)90028-0](https://doi.org/10.1016/0304-3932(86)90028-0)
- Alesina, A., & Ardagna, S. (1998). Tales of fiscal adjustment. *Economic Policy*, 13(27), 487–545. <https://doi.org/https://doi.org/10.1111/1468-0327.00039>
- Amano, R. A., & Wirjanto, T. S. (1997). Intratemporal substitution and government spending. *Review of Economics and Statistics*, 79(4), 605–609. <https://doi.org/10.1162/003465397557187>
- Amano, R. A., & Wirjanto, T. S. (1998). Government Expenditures and the Permanent-Income Model *. *Review of Economic Dynamics*, 1(3), 719–730. <https://doi.org/https://doi.org/10.1006/redy.1998.0021>
- Ambler, S., Bouakez, H., & Cardia, E. (2017). Does the crowding-in effect of public spending on private consumption undermine neoclassical models? *Research in Economics*, 71(3), 399–410. <https://doi.org/10.1016/j.rie.2017.04.004>
- Aschauer, D. A. (1985). Fiscal policy and aggregate demand. *American Economic Review*, 75(1), 117–127.
- Bailey, M. J. (1971). *National Income and the Price Level: A Study in Macroeconomic Theory* (2nd ed.). New York: McGraw-Hill.
- Barro, R. J. (1981). Output effects of government purchases. *Journal of Political Economy*, 89(6), 1086–1121.
- Baxter, M., & King, R. G. (1993). Fiscal Policy in General. *The American Economic Review*, 83(3), 315–334.
- Bertola, G., & Drazen, A. (1993). Trigger points and budget cuts: Explaining the effects of fiscal austerity. *American Economic Review*, 89(9), 11–26.
- Blanchard, O. J. (1990). [Can Severe Fiscal Contractions Be Expansionary? Tales of Two Small European Countries]: Comment. *NBER Macroeconomics Annual*, 5, 111–116. <https://doi.org/10.2307/3585134>
- Boehm, C. E. (2019). Government consumption and investment: Does the composition of purchases affect the multiplier? *Journal of Monetary Economics*. <https://doi.org/10.1016/j.jmoneco.2019.05.003>
- Bouakez, H., & Rebei, N. (2007). Why does private consumption rise after a government spending shock? *Canadian Journal of Economics*, 40(3), 954–979. <https://doi.org/10.1111/j.1365-2966.2007.00438.x>
- Chang, Y., Choi, Y., & Park, J. Y. (2017). A new approach to model regime switching. *Journal of Econometrics*, 196(1), 127–143. <https://doi.org/10.1016/j.jeconom.2016.09.005>
- Cour, P., Dubois, E., Mahfouz, S., & Pisani-Ferry, J. (1996). *The Cost of Fiscal Retrenchment Revisited: How Strong is the Evidence?* (No. 1996–16). Paris.
- Dawood, T. C., & Francois, J. N. (2018). Substitution between private and government consumption in African

- economies. *Economic Modelling*, 73(May 2017), 129–139. <https://doi.org/10.1016/j.econmod.2018.03.012>
- Devereux, M. B., Head, A. C., & Lapham, B. J. (1996). Monopolistic competition, increasing returns, and the effects of government spending. *Journal of Money, Credit and Banking*, 28(2), 233–254.
- Dickey, D. A., & Fuller, W. A. (1979). Distribution of the Estimators for Autoregressive Time Series With a Unit Root. *Journal of the American Statistical Association*, 74(366), 427. <https://doi.org/10.2307/2286348>
- Giavazzi, F., & Pagano, M. (1990). Can severe fiscal contractions be expansionary? Tales of two small European countries. *NBER Macroeconomics Annual*, 5, 75–111.
- Giavazzi, F., & Pagano, M. (1996). Non-Keynesian effects of fiscal policy changes: International evidence and the Swedish experience. *Swedish Economic Policy Review*, 3(1), 67–103.
- Graham, F. C. (1993). Fiscal Policy and Aggregate Demand: Comment. *The American Economic Review*, 83(3), 659–666.
- Hajamini, M., & Falahi, M. A. (2018). Economic growth and government size in developed European countries: A panel threshold approach. *Economic Analysis and Policy*, 58, 1–13. <https://doi.org/10.1016/j.eap.2017.12.002>
- Hamilton, J. D. (1989). A new approach to the economic analysis of nonstationary time series and the business cycle. *Econometrica*, 57(2), 357–384.
- Ho, T. W. (2001). The government spending and private consumption: A panel cointegration analysis. *International Review of Economics and Finance*, 10(1), 95–108. [https://doi.org/10.1016/S1059-0560\(00\)00073-3](https://doi.org/10.1016/S1059-0560(00)00073-3)
- Höppner, F., & Wesche, K. (2000). *Non-linear effects of fiscal policy in Germany: A Markov-switching approach* (No. 9/2000). Bonn.
- Jahan, S., Mahmud, A. S., & Papageorgiou, C. (2014, September). What is Keynesian economics? *Finance & Development, IMF*, 51(3), 53–54.
- Jha, S., Mallick, S. K., Park, D., & Quising, P. F. (2014). Effectiveness of countercyclical fiscal policy: Evidence from developing Asia. *Journal of Macroeconomics*, 40, 82–98. <https://doi.org/10.1016/j.jmacro.2014.02.006>
- Kamps, C. (2001). *Fiscal consolidation in Europe: Pre- and post-Maastricht* (No. 1028). <https://doi.org/http://dx.doi.org/10.2139/ssrn.753008>
- Karras, G. (1994). Government Spending and Private Consumption: Some International Evidence. *Journal of Money, Credit and Banking*, 26(1), 9. <https://doi.org/10.2307/2078031>
- Kirchgässner, G., Wolters, J., & Hassler, U. (2013). *Introduction to Modern Time Series Analysis* (2nd ed.). Berlin, Heidelberg: Springer-Verlag.
- Kormendi, R. C. (1983). Government debt, government spending, and private sector behavior. *The American Economic Review*, 73(5), 994–1010. <https://doi.org/10.2307/1814667>
- Mankiw, N. G., Romer, D., & Weil, D. N. (1992). A Contribution to the Empirics of Economic Growth. *The Quarterly Journal of Economics*, 107(2), 407–437. <https://doi.org/10.2307/2118477>
- McDermott, J., & Wescott, R. F. (1996). An empirical analysis of fiscal adjustments. *IMF Staff Papers*, 43(4), 725–753.
- Perotti, R. (1999). Fiscal Policy in Good Times and Bad. *The Quarterly Journal of Economics*, 114(4), 1399–1436. <https://doi.org/10.1162/003355399556304>
- Phelps, E. (1961). The golden rule of accumulation: A fable for growthmen. *American Economic Review*, 51(4), 638–643.
- Schwarz, G. (1978). Estimating the Dimension of a Model. *The Annals of Statistics*, 6(2), 461–464. <https://doi.org/10.1214/aos/1176344136>
- Solow, R. M. (1956). A Contribution to the Theory of Economic Growth. *The Quarterly Journal of Economics*, 70(1), 65. <https://doi.org/10.2307/1884513>
- Solow, R. M. (1957). Technical Change and the Aggregate Production Function. *The Review of Economics and Statistics*, 39(3), 312. <https://doi.org/10.2307/1926047>
- Sulekha, A., Mary, R. F. P., & Tharmalingam. (2019). Impact of inflation of the household spending power. *International Journal of Recent Technology and Engineering*, 7(5), 8–11.
- Varlamova, J., & Larionova, N. (2015). Macroeconomic and Demographic Determinants of Household Expenditures in OECD Countries. *Procedia Economics and Finance*, 24(July), 727–733. [https://doi.org/10.1016/S2212-5671\(15\)00686-3](https://doi.org/10.1016/S2212-5671(15)00686-3)
- Wang, L., & Gao, W. (2011). Nonlinear Effects of Fiscal Policy on Private Consumption: Evidence from China. *China & World Economy*, 19(2), 60–76. <https://doi.org/10.1111/j.1749-124X.2011.01235.x>



Dynamic Capabilities and Performance: The Mediating Role of Firm Competence

Gabriel Kitenga¹, Dr. J. M. Kilika¹, Dr. A. W. Muchemi¹

¹Department of Business Administration, School of Business, Kenyatta University, Nairobi, Kenya

Correspondence: Gabriel Kitenga email: gkitenga@yahoo.com

Abstract

This study aimed at determining the mediating effect of firm competence on the relationship between dynamic capabilities and performance. The study was founded on positivism philosophy and adopted an explanatory and exploratory research design. The population of the study comprised of 70 food manufacturing firms in, Kenya. Stratified random sampling method was used to identify a sample of 295 respondents. A semi-structured self-administered questionnaire was used to collect primary data. Prior to data collection, a pilot study was conducted to ensure reliability of the questionnaire. The reported findings were obtained from 190 respondents who were senior managers in the respondent firms responsible for finance, human resources, operations marketing and corporate relations. Measures of central tendency including the mean and standard deviation were used to summarize the variable characteristics Data was analyzed using descriptive statistics. Multiple regression analysis was used to test the study hypotheses. The findings of the study showed that dynamic capabilities have a significant direct effect on performance and that the effect of dynamic capabilities on performance is partially mediated by firm competence. The findings also showed that firm competence has a direct and significant effect on performance also that dynamic capabilities can partially mediate the effect of firm competence on firm performance.

Keywords: Dynamic Capabilities, Firm Competence, Firm Performance

1. Introduction

Firm Performance is an important concept among business managers as well as scholars in business research. Concerns over firm performance are often motivated by the perception of threats to the durability of the firm. These concerns seem to be justified by the ever-growing competition for market and resources (Maltz, Shenar & Reilly 2003). Globally, firms are looking for strategies that will enable them cope with the dynamic global competition (Easterby-Smith & Prieto, 2008). The search for how to respond to environmental turbulence has led several scholars and strategic managers to view Dynamic Capabilities as being central to strategy and firm Performance (Teece, 2017).

According to Eisenhardt and Martin (2000), competence is crucial to a firm because it is a mechanism which firms use to, leverage, combine, and reconfigure resources. Building on Bane-Hani & AL-Hawary, (2009) and Winter, (2003) that firm competencies indirectly affects performance this study proposes a model where Firm competence

mediate the effect of capabilities on Performance through their interaction with other corporate intellectual phenomena to support organizational success.

1.1 Firm Performance

Despite being common in academic literature the concept of firm performance is difficult to define because of its many meanings. Hubbard (2006) observes that firm performance does not have a universally accepted definition although it is a widely used variable in business research. Richard, Devinney, Yip and Johnson (2009), conceptualized the term in terms of the extent to which firms achieve their goals. Hult *et.al.*, (2008) defined firm performance as the efficiency and effectiveness in utilization of resources as well as the accomplishment of firm goals through core strategies. According to Barney (2001), the concept of firm performance is grounded on the idea that a firm is the interaction of productive resources for the purpose of creating value. Therefore, as long as the firm creates a value that meets or exceeds the value that its providers expect, resources will continue to be made available and the firm will continue to survive and prosper (Gavrea, Ilies & Stegorean, 2011). Pierre, Timothy, George, and Gerry (2009) observe that recent empirical researches have used Financial, Operational and Market-based performance measures. According to Richard and Bromley (2009), organizational performance encompasses three specific areas of firm outcomes: (a) financial performance for example profits, return on assets and return on investment (b) product market performance (such as sales, market share.); and (c) shareholder return for example total shareholder return.

According to Richard, Devinney, Yip, and Johnson (2009), Operational Performance focuses on extending to which an organization is efficient in producing the goods and services that customers really want at the lowest cost and effort as possible. Environmental performance measures performance in terms of the amount of resources firms use for their operations (such as energy, land, water) and the by-products of their operations (such as solid waste, air pollution, and chemical residues) (Gross, 2015). Social performance measures performance in terms of the impact that firms have on the communities in which they operate (Taouab & Issor, 2019). This study used profit growth, customer satisfaction, employee satisfaction, environmental stewardship, corporate governance, and social excellence as indicators of firm performance of manufacturing firms in Kenya.

1.2 Dynamic Capabilities

According to Teece (2007), dynamic capabilities consist of three types of abilities: One, to sense new opportunities, Two, to sense those opportunities and Three to sustain competitive edge through improving, integrating and when imperative, reconfiguring the business enterprise's key tangible and intangible activities. Helfat *et al.*, (2007) assert that dynamic capabilities are the capacity of an organization to create, extend or modify its resource base. Wang and Ahmed (2007) defined them as a firm's orientation to constantly integrate, reconfigure, renew, and recreate its resources capabilities and reconstruct its core capabilities in response to the changing environment to attain and sustain competitive advantage. Dynamic capabilities have also been seen as a learned and stable pattern of collective activity through which the organization systematically generates and modifies its operating routines in pursuit of improved effectiveness (Zolfo & Winter, 2002). Eisenhardt and Martin (2000) refer to dynamic capabilities as a set of identifiable processes such as product development, decision making and alliancing. Helfat *et al.* (2007) described them as processes or routines which may have become embedded in the firm over time and are employed to reconfigure the firm's resource base by deleting decaying resources or recombining old resources in new ways.

Ambrosini and Bowman (2009) state that the role of dynamic capabilities is to impact on the firm's extant resource base and transform it in such a way that a new bundle or configuration of resources is created so that the firm can sustain or enhance its performance. According to Easterby-Smith and Prieto (2008), dynamic capabilities can take on multiple roles in organizations, such as changing resource allocations, organizational processes, knowledge development and transfer and decision making. Winter (2003) argues that in order to compete successfully in their markets, firms need dynamic capabilities to help them to upgrade their ordinary capabilities, or to create new ones so as to sustain performance. According to Wang and Ahmed (2007), absorptive capability, adaptive capability,

and innovative capability are four main categories found across industries. Teece, (2008) found marketing and managerial capabilities as other categories found across industries.

1.3 Firm Competence

Firm Competence has been defined as the combination of multiple resources to execute a set of activities which the firm performs exceptionally well, and which gives the firm competitive advantage over its peers (Nguyen, 2008). Competencies are the set of specialized skills, qualities and characteristics of knowledge that enable a firm to excel in their performance and achieve higher level of customer satisfaction than its peers through the integration of resources, technology, and routines (Hitt, et al., 2001). Firm Competences interact with other intellectual corporate phenomena to support firm survival and success (Winter 2003). When a firm's strategic tangible and intangible resources and capabilities combine, they create competences which the firms excel at and gives it competitive advantage over its peers (Cockburn, Henderson Stern, 2000). Hill and Jones (2010) use the term distinctive competence and argue that perspectives on competence center on the uniqueness and comparative performance of something arising within an organization in the light of the efforts of its competitors.

According to Fai and Tunzelmann (2001) organizational competence is an aspect of the business believed to have the greatest strategic value and measured at the level of the organization rather than at the level of the individual. According to Danneels (2002) organizational competence refers to a firm's invisible strategic assets such as corporate reputation of the firm and its brands or image, product or service quality, knowledge of customer needs, ability to serve its customers and customer loyalty.

According to Agha, Alrubaiee & Jamhour (2012) foundational competencies are the set of skills, knowledge, and attitudes and attributes necessary for broad job functions. They are supporting level competencies linked to successful performance and are desirable regardless of an individual's area of expertise or role. Jabbouri, Zahiri (2014) cite oral communication, adaptability, initiative, integrity professionalism, cultural sensitivity as indicators of foundational competence. According to Danneels (2002) technological competence is the capability that enables the firm to design and manufacture a physical product or service with certain features. It is constituted by such technically related resources as design and engineering know-how, product, process design equipment, manufacturing facilities and procedures for quality control. According to Wahab (2012) technology refers to tools, devices, and knowledge that mediate between inputs and outputs (process technology) and/or create new products or services (product technology).

According to Agha, Alrubaiee and Jamhour (2012) functional competence is the knowledge, skill, and abilities required to fulfill specific job tasks, duties, or responsibilities. It is a specific knowledge or skill area that relates to successful performance in the job. According to Wahab (2012), functional competence is the combination of practical, theoretical, and cognitive skills needed to perform a specific function. Ahadzie, Proverbs, Olomolaiye, & Ankrah, (2009) observe that functional competencies are job-specific and are associated with the technical functions of a firm such as organizing, planning, coordinating, and controlling and have an influence on the individual and firm performance).

Nguyen (2008) argues that although resources, capabilities, and competencies are closely related to each other, they can be distinguished by their characteristics; thus, Firm resources refer to its financial, physical, human, technological, and organizational capital. Firm Capabilities are intangible and refer to a company's skills at coordinating its resources and putting them to productive use. Firm Competence, on the other hand, refers to the firm's unique strength that enables the firm to achieve superior efficiency, quality, innovation, or customer responsiveness compared to its peers. According to Baker, Pearson, & Chipman (2009), firm competencies refer to the capabilities of an organization that describes performance excellence and difficult to imitate employee skills and processes required to achieve success. Dynamic Capabilities, on the other hand, refer to a firms' ability to adjust its competences over time and is related to resources necessary for change. According to Eisenhardt and Martin (2000), competence is crucial to a firm because it is one of the mechanisms by which firms use to leverage, recombine, and reconfigure resources. Hill and Jones (2001) observe that firms can enhance their performance by exploiting their competences which enables them to achieve superior efficiency thus enabling it to lower its cost,

charge a higher price and in turn outperform its competitors. Cockburn, Henderson, and Stern (2000) viewed firm competence from four distinct approaches: organizational competence, foundational competence, technological competence, and functional competence

1.4 Food Manufacturing Firms in Kenya

Food manufacturing firms display distinctive characteristics ranging from family-owned to publicly own. Some of the firms are foreign-owned while others are locally owned. Flour mills represent 18% of the total number of Food Manufacturing firms. Processing of edible oils represents 18% while sugar and confectionery processing comprise 12%. The rests are bakeries and processors of vegetable, fruit, dairy, fish, and meat. (Promar Consulting, 2016). In terms of value addition, sugar and confectionery contribute 15%, edible oils 10% and flour products 9% total value created by Food Manufacturing firms. The sector contributes 30% of manufacturing GDP and 40% of all employees in the manufacturing sector (GOK, 2018).

1.5 Statement of the Problem

Despite its importance to strategic management, research on firm performance suffers from a lack of consensus on its definition and selection of indicators (Combs, Crook, & Shook, 2005). According to Hubbard, (2009), measuring performance is difficult especially when what s to be measured keeps changing and is likely to become more complex with the increasing need to satisfy the ever-changing needs of the organization's stakeholders. Furthermore, many studies have measured firm performance with a single indicator (mainly financial performance) and thus erroneously representing the concept as unidimensional (Glick, Washburn, & Miller, 2005). As such, the field of strategic management clearly needs more studies to get a clearer conceptualization of firm performance and identify better measurement frameworks (Richard, Devinney, Yip, & Johnson, 2009).

How firms' dynamic capabilities lead to their competitive advantage and improved firm performance has been a core issue and full of debates. Indeed, there are different perceptions of how and whether dynamic capabilities influence firm performance (Akintoye, 2008). For instance, scholars have portrayed Dynamic Capabilities as direct drivers, preconditions, moderators, or mediators of firm Performance (Arend and Bromiley, 2009). Therefore, further empirical research is needed to validate previous studies on the relationship between dynamic capabilities and performance. Furthermore, there has been conflicting research findings on the effect of dynamic capabilities. For instance, Drnevich and Kriauciunas (2011) report negative direct effects of dynamic capabilities on firm performance while Protogerou *et al.* (2011) report that there is no direct performance effect of dynamic capabilities.

The interaction between Dynamic Capabilities and other organizational phenomena such as Firm Competence to influence performance has not been fully investigated (Wang & Ahmed (2007). Furthermore, studies on the performance of manufacturing firms in Kenya have not considered the influence of dynamic capabilities on performance in the context of food processing firms.

Furthermore, most of empirical studies on the effect of Dynamic Capabilities on firm Performance were done in developed countries with different cultural and economic settings. This makes it difficult to generalize the results to a Kenyan setting. More empirical studies are therefore needed in developing countries to provide more academic rigor to the concept (Protogerou, Caloghirou & Lioukas 2012). According to (Arend & Bromiley, 2009) a large number of studies on Dynamic Capabilities relied on small samples. This may reflect a careful choice of firms that researchers believed would possess Dynamic Capabilities. This raises issues of, generality and reliability of results of results to other settings, companies, or countries. Moreover, most key empirical studies linking Dynamic Capabilities and Performance considered only financial Performance and did not consider non-financial Performance.

1.6 Objectives of the Study

The general objective of this study was to investigate the effect of Dynamic Capabilities on Performance of Food Manufacturing firms in Kenya. Specifically, the study sought to

- (i) Examine the effect of dynamic Capabilities on Performance of Food Manufacturing firms in Kenya.
- (ii) Investigate the mediating effect of Firm Competence on the relationship between Dynamic Capabilities and Performance of Food Manufacturing firms in Kenya.

1.7 Research Hypotheses

The study tested the following hypotheses:

H₀₁: Dynamic Capabilities have no significant effect on Performance of Manufacturing firms in Kenya.

H₀₂: Dynamic Capabilities have no significant effect on Firm Competence of Manufacturing firms in Kenya

H₀₃: Firm Competence has no mediating effect on the effect of Dynamic Capabilities on Performance of Manufacturing firms in Kenya

H₀₄: Firm Competence has no significant effect on Dynamic Capabilities of Manufacturing firms in Kenya.

H₀₅: Dynamic Capabilities have no mediating effect on the effect of Firm Competence on Performance of Manufacturing firms in Kenya

1.8 Significance of the Study

This study is significant in several ways. First, the overall findings of the study helped in informing policy decisions on how to mitigate food security in the country through using Dynamic Capabilities to enhance Performance of Food Manufacturing firms. Secondly, the study provides managers of Food Manufacturing firms with more information on how Dynamic Capabilities interact among themselves and Firm Competence to influence Performance.

Third, this study contributed to the existing body knowledge by showing how Dynamic Capabilities interact with other organizational variables such as Firm Competence to impact Performance. Further, the study helped fill the gap left by local studies which investigated the relationship between Dynamic Capabilities and financial Performance by introducing social excellence and environmental stewardship to the traditional financial measures commonly used to measure performance. Finally, the study provided useful insights to future scholars who want to study dynamic capabilities.

2. Literature Review

2.1 Theoretical Review

This study was informed by the Dynamic Capabilities theory as the main theory. This theory was complemented by the Competence-Based Theory, The Stakeholder Theory, and the RBV theory. The review lays the theoretical foundation for the study.

2.1.1 The Competence-based Theory of the firm

Philip Selznick (1957) was the originator of the theory. It emerged from the work of Oskar Morgenstern (1951) who perceived organizations as bundles of competencies. According to Prahalad and Hamel, (1990) the theory evolved to complement the RBV. In this theory, competence is seen as the ability to sustainably deploy resources in a way that supports the firm to achieve its objective of creating value for its stakeholders (Delamare & Winterton, 2005) The theory broadly states that a firm can only perform better than others if it can use available resources more effectively and/or efficiently by applying competences in ways its rivals cannot imitate (Sanchez & Heene 2004). Prahalad and Hamel, (1990) argue that the competence-based theory complements the dominant Potterian view in the field of strategy by drawing attention to the internal aspects of organizations like dynamic capabilities as being sources of superior performance.

Scholars argue that although an organization may have many competencies and capabilities, only a few of these are combined in such way as to become core competences (Prahalad & Hamel, 1990). By focusing on their core

competencies, firms get competitive advantage by doing the things which they excel at (Rust *et al*, 2004). Firm competencies that do not create imitable products or services are not core and do not give the firm sustainable competitive advantage (Teece 2004). Thus under the competence based framework, Firm A can only be more successful than B if A is in a position to make use of the available resources more effectively and/or efficiently than B.

The competence-based view contributes to strategic management by offering insights that help to explain corporate success. It also helps to explain why firms perform differently. However, although the theory offers a framework to explain the roots of corporate success, its contributions are yet to be analyzed in a comprehensive way (Freiling, 2004). The study used the Competence Based Theory of the firm to inform the mediating variable.

2.1.2 Resource Based View (RBV)

The RBV was suggested by Wernerfelt (1984) and popularized by Barney (1991) using insights provided by Penrose (1959). According to Ireland, Michael, Hitt and Sirmon (2003), it is drawn from at least four theoretical sources; the study of distinctive competencies, Ricardian economics, Penrosian economics and the study of the anti-trust implications of economics. In RBV firms are conceived as bundles of resources (Wang & Martin 2007). According to Peteraf and Barney (2003) the key determinants of firm Performance are the tangible and intangible assets resources owned by the firm.

The RBV presents a connection between internal resources, strategy, and the performance of the organization (Torrington, 2005). RBV was a shift from earlier suggestions that superior performance comes from managing factors that are external to the firm (Peteraf & Barney 2003). In essence the underlying presumption of theory is that it is the resources and competencies inherent in the firm rather than in the environment which determines firm performance (Wang & Martin 2007). According to Peteraf and Bergen (2003), a central premise of the resource-based view is that firms compete on the basis of their resources and capabilities. The resource-based view suggests that a firm A is more successful than firm B if A controls more effective and/or efficient resources than B (Barney 1991; Hunt 2000).

According to Helfat and Peteraf (2003), a firm's resources at a given time could be defined as those (tangible and intangible) assets which are tied semi permanently to the firm. **Tangible** resources can easily be bought in the market so they confer little advantage to the companies in the long run because rivals can soon acquire the identical assets. Makadok (2003) argued that unlike physical resources, intangible resources such as brand reputation are built over a long time and are something that other companies cannot buy from the market. He argues that intangible resources usually stay within a company and are the main source of sustainable performance. Barney (1991) argued that firm's tangible and intangible resources must be valuable, rare, imperfectly imitable, and non-substitutable (VRIN) to be a source of superior performance. The theory emphasizes that value creation and superior performance of a firm is affected by combination of the competitive strategy and its resource base (Eisenhardt & Martin, 2000). The theory contributes to strategic management by explaining how a firm can increase performance by acquiring and utilizing VRIN resources (Alvarez, & Barney, 2000). One weakness of RBV is that it is static and therefore does not explain how to sustain Performance in a dynamic market (Kraaijenbrink, Spender, & Groen, (2010). Teece (2010) explained that the RBV was not able to provide explanations as to how some successful firms demonstrated timely responsiveness and rapid and flexible product innovation along with the management capability to effectively coordinate and redeploy internal and external competences.

Teece (2010) further argued that it is essential to consider the changing nature of the external environment and hence the role of strategic management, which is principally about adapting, integrating, and reconfiguring internal and external organizational skills, resources and functional competencies toward the changing environment. Proponents of the RBV have also been criticized for poorly defining the core constructs of the theory Foss and Knudsen, (2003). RBV scholars have been criticized for failing to agree on the definition of key variables and constructs, leading to inconsistent presentations of theory (Bromley 2005). This study used the RBV to inform the independent variables.

2.1.3 Dynamic Capabilities Theory

According to Ambrosini and Bowman (2009), Terence's (1990) working paper is probably the first contribution developing the notion of dynamic capabilities. Dynamic Capabilities theory itself was developed by (Teece & Pisano 1994). Teece, Pisano and Shuen (1997, 2007) saw competitive advantage in turbulent environments as a function of dynamic capabilities rather than competitive positioning or industry conflict. They used the term "dynamic" to reflect the capacity to renew competences so as to achieve congruence with the changing environment.

According to Pisano (2014), this theory evolved from the evolutionary theory of the firm. The theory enhances the RBV (Teece, Pisano & Shuen, 1997; Teece 2017; Zahra *et.al.*, 2006). According to this theory, firms achieve sustainable competitive advantage by reacting rapidly and flexibly to changing market environments (Teece 2017). Dynamic Capabilities theory explains long-run firm survival by showing how firms can manage competitive threats by redeploying their resources (Teece, 2010). In this theory, firm Performance depends on distinct processes shaped by asset positions and the evolution path(s) the firm has adopted or inherited (Teece et al, 1997, Pisano, 2016). The theory suggests that Performance a firm during periods of rapid change depends on its ability to sharpen its technological, organizational, and managerial processes (Teece, 2017). Firms use Dynamic Capabilities to reconfigure their resources as markets emerge, collide, mutate, or cease (Teece, Pisano & Shuen, 1997).

According to Teece (2018) the price system is inefficient in allocation of a firm's resources. Therefore, managers give directives to deploy in value-enhancing ways. Because managers make decisions under uncertainty, they do not create once-and-for-all solutions but continually reconfigure firm resources and competences as needed (Zara *et.al.* 2006). Teece (2006) cast dynamic capabilities against Porter's five forces, and points out that in the latter, the sustainable advantage comes from hiding behind market structures, erecting entry barriers or building them if they did not exist. In the dynamic capabilities framework, market structure does not matter.

Teece (2012) argues that in this framework, sustainable performance comes from shapping internal processes, structures and procedures to generate innovations, be they technological or organizational. He further argued that the dynamic capabilities framework recognizes analytical functions that must be performed at the enterprise level to sustain success. Danneels (2002) suggested two levels of dynamic capabilities. The first order capabilities are the firm's extant resource base, the resources that allow the firm to directly earn a living. The second-order capabilities refer to dynamic capabilities that enable the creation of new capabilities. Winter (2003) argued that the dynamic capability hierarchy begins with operating capabilities or zero-level capabilities that allow firms to earn a living in the present. The first order capabilities are that allow for a change in zero-order capabilities to occur. Higher-order capabilities are the outcome of organizational learning which results in creating or modifying a firm's dynamic capabilities.

According to Ambrosini and Bowman (2009), one of the criticisms of the dynamic capabilities concept is that they are difficult to measure empirically as are the underlying operational processes as well as the relationship between dynamic capabilities and firm performance. It is also difficult to measure the routines and processes that are often idiosyncratic to firms or part of resource bundles. The basic assumption of the theory is that a firm dynamic capabilities should be used to modify competitive positions to build long-term competitive advantage. This study used the Dynamic Capabilities Theory to inform the independent variable.

2.1.4 The Stakeholder Theory

The stakeholder theory was advanced by Freeman (1984). He built it on the work of Mitroff, Mason (1982) and Emshoff. (1978). The use of the term stakeholder grew out of the pioneering work at Stanford Research Institute (now SRI International) in the 1960s. Freeman (2004) defined stakeholders as those groups who are vital to the survival and success of the organization. The Theory presents the corporation as a constellation of cooperative and complete interests. In this regard, Friedman (2006) was of the view that the organization itself should be thought of as grouping of stakeholders and the purpose of the organization should be to manage their interests, needs and viewpoints. The Theory suggests that firms should cater to the interests of stakeholders to maximize corporate wealth and the collective benefits of all stakeholders (Freeman 1994). The focus of stakeholder theory, therefore,

is first, the purpose of the organization and second its benefit to the stakeholders (Dessler, 2003). It presents a useful framework for examining the connection between stakeholder management and achievement of various corporate performance goals.

The Theory presents stakeholders as groups with legitimate interests in procedural and substantive aspects of corporate activity Stakeholders are uniquely positioned to affect the performance of the organization through withholding or providing resources and infrastructure (Rowley & Berman, 2000). Firms, therefore, have an obligation to promote the interests of all stakeholders (Harrison & Wicks 2013). Post, Preston and Sachs (2002) posit that a firm can last over time only if it can meet or exceed the expectations of its key stakeholders such as customers, shareholders, employees, suppliers and competitors. Luk et al. (2005) claim that stakeholder orientation influences strategic planning and is therefore positively related to performance in terms of sales growth, market share, new product success and organization's corporate social performance. The theory contributes to strategic management theory by introducing the perspective that organizational performance can be viewed as the extent to which the organization has been effective in meeting the expectations of its stakeholders. The theory has been criticized for assuming that the interests of the various stakeholders of an organization can be balanced against each other. In this study, the stakeholder theory was used to inform the dependent variable.

2.2 Empirical Review

Protogerou, Caloghirou and Lioukas (2011) investigated the effect of dynamic capabilities on firm performance. The study particularly addressed the question of whether dynamic capabilities affected performance directly or indirectly. Data was collected from a sample of 271 firms drawn from a population of 1400 Greek firms belonging to various manufacturing industries, such as food and beverage industries, printing and publishing, chemical industries, industrial machinery and equipment. The data was collected using questioners administered on CEOs as key informants. Structural equation modelling was employed to explore the relationships between dynamic capabilities, functional competences and firm performance.

A similar study conducted by Ahsan, Naveed & Sajid (2019) sought to understand the role of dynamic capabilities in dealing with market uncertainties in Pakistan. Data was collected 516 participants drawn from small and medium enterprises using a self-administered questionnaire and analyzed using multiple regression techniques. The results of the analysis showed that organizational performance can significantly increase if a firm develops dynamic capabilities. A cross-sectional survey by Iqra and Ahmed (2019) sought to investigate the contribution of tangible and intangible resources and capabilities on performance. Primary Data was collected from 202 Pakistani business firms using a close-ended questionnaire. Data were analyzed using confirmatory Factor analysis and structural equation modeling. The results showed significant evidence that dynamic capabilities predict firm performance.

Nguyen (2008) studied the relationship between functional competence and firm Performance. The target population of the study was 4114 manufacturing firms identified through a website published by Vietnam Chamber of Commerce and Industry. Primary data was collected from 125 managers using a questionnaire administered through mail. Analysis of data using simple regression found that manufacturing firms that put emphasis on marketing, human resource and R&D competences earn higher Performance. The findings also showed that functional competence does not have a significant effect on market Performance.

An empirical survey was conducted by Dubey and Ali (2011) to understand how functional competence affects firm Performance. Functional competence was operationalized in terms of manufacturing competence. Financial and non-financial metrics were used to measure Firm Performance. The study used data collected from 450 manufacturing firms listed by the Confederation of Indian Industries using a mail survey. The data was analyzed using simple regression analysis. The study found that functional competence has no significant impact on firm Performance. One limitation of the study was that it ignored the effect of important competence such as finance and planning. These results contradicted previous studies which had found that functional competence positively affects firm Performance. One limitation of this study was that it used perceptual rather than objective measures of performance.

Empirical findings of the study suggested that dynamic capabilities are antecedents to functional competences which in turn have a significant effect on performance. The study also found that the direct effect of dynamic capability on performance is insignificant. The study concluded that the effect of dynamic capabilities on performance is mediated by functional competences. The results thus confirmed the contention by (Winter, 2003) that Dynamic Capabilities influence firm Performance through functional competences. The limitation of study was that it used self-reported data thus it had potential of survey biases and therefore the findings may not coincide with objective reality.

A Study by Agha, Alrubaiee and Jamhour (2012) investigated the relationship between Firm Competence and firm Performance. Core competence was operationalized in terms of shared vision, cooperation, and employee empowerment. Performance was operationalized in terms of competitive advantage measured tern's flexibility and responsiveness. Primary data was collected though an electronic survey administered on 77 managers of firms in the UAE paint industry. The study found that Firm Competence positively affects firm performance. The study concluded that to remain competitive, managers should increase firm performance by creating core competences.

Massoud (2013) investigated the impact of functional competence on firm performance. The survey used data collected from 62 managers of 17 companies manufacturing pharmaceuticals in Jordan using structured questionnaires. The study applied descriptive statistics, simple regression, and multiple regression procedures to test the hypothesis. The findings showed that functional competence has a significant effect on firm performance. The results also showed that production competence, and marketing competence have an impact on performance. Further results showed that IT system and human resource competencies do not have any effect on firm performance. One limitation of the study was that it ignored moderating variables such as management style and company size.

A study by Jabbouri & Zahar (2014) studied the effect of core competences on firm performance. The study collected primary data using a self-reported questionnaire administered on 200 managers in 10 private banks in Iraq. Results of data analysis showed a strong correlation between core competences and firm Performance. The value of this study was that it highlighted the importance of core competence in improving organizational performance.

A study by Rehman and Saeed (2015) investigated the effect of Dynamic Capabilities on firm Performance and the moderating effect of firm competencies on the correlation between Dynamic Capabilities and performance. Firm Competence was operationalized in terms of marketing capabilities and technical competences. The study categorized Dynamic Capabilities in terms of sensing capabilities, coordinating capabilities, learning capabilities, and integrating capabilities. Financial and non-financial measures were used to measure performance. Primary data was collected through questionnaires administered on 104 professionals working in the Pakistani paper sector. The data were analyzed using multiple regression analysis. The findings of the study suggested that firm competencies have a moderating effect on the relationship between Dynamic Capabilities and firm performance. The finding also suggested that Dynamic Capabilities have no significant effect on Performance

Broadly, evidence supporting relationship between Firm Competence and organizational Performance is mixed in terms of significance of the relationship. In addition, most studies were done in the context of developed countries. Studies on the mediating effect of Firm Competence on the relationship between Dynamic Capabilities and Performance of Food Manufacturing firms in Kenya are rare. Moreover, most studies on this relationship have considered only financial Performance.

2.3 Conceptual Framework

Based on theoretical models found in the literature review the conceptual framework shown in Fig. 1 was developed.

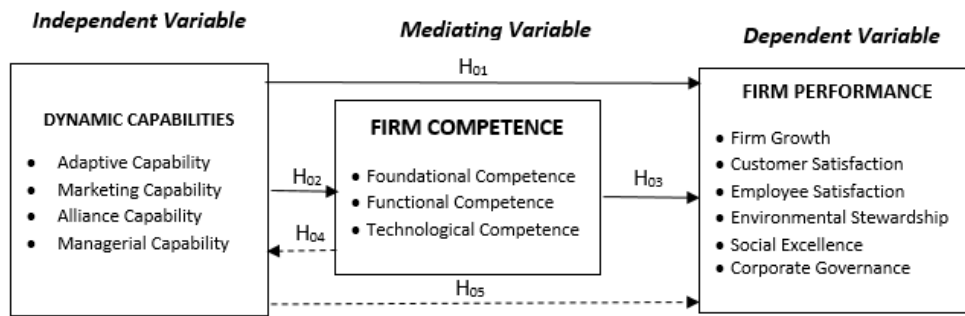

Fig 1: Conceptual model

Source: Authors 2020

In the model, it was hypothesized that Dynamic Capabilities affect the performance. The model further hypothesized that effect of firm Dynamic Capabilities on performance is mediated by firm competence. In this study, Dynamic Capabilities were operationalized in terms of adaptive capabilities, marketing capabilities, alliancing capabilities and managerial capabilities. Firm Competence, the mediating variable was operationalized in terms of foundational competence, technological competence, and functional competence. Performance, the dependent variable, was operationalized in terms of profit growth customer satisfaction, employee satisfaction, environmental stewardship, social excellence and corporate governance.

3. Research Methodology

This study inclined to positivistic view in order to obtain an objective view of the relationship between dynamic capabilities, firm competence and performance of selected food processing firms in Kenya. Positivism relates to the philosophical stance of the natural scientist and entails working with an observable social reality to produce law-like generalizations (Easterby-Smith, Thorpe & Jackson, 2008). It focuses on strict scientific empiricist method designed to yield pure data and facts free of human interpretation or bias. The positivist adopts the stance that the researcher will operate remotely from the social world and that evaluation of phenomena identified will be approached through objective methodologies (Stiles, 2003). Positivism derives a quantitative perspective which holds that there is an objective reality that can be expressed numerically with explanatory and predictive power (Neuman, 2006; Furrer, Thomas & Goussevkaia, 2008). Problem solving under this approach follows a pattern of formulating hypotheses in which assumptions of social reality are made and hypotheses tested often using quantitative techniques (Stile, 2003). The study shall involve formulation of hypothesis which shall then be tested using quantitative techniques based on facts obtained from data collected from both primary and secondary sources in a survey of food processing firms in Nairobi County, Kenya.

3.1 Research Design

Based on the purpose of the study and the philosophical orientation adopted, the study used a descriptive, causal and cross-sectional survey research design. This approach was chosen to achieve complementarity between the various paradigms and to discover what may not have been discovered if only one approach is used. Descriptive research is used to obtain information concerning the current status of a phenomena and to describe "what exists" with respect to variables (Saunders 2011). Bryman and Bell describe descriptive research design as an organized empirical enquiry where the researcher does not have direct control of the independent variable since its manifestation has already taken place and this reduces the possibility of bias. The explanatory research design looks for explanations on the nature of certain relationships and investigates the cause and effect relationship between variables (Saunders, 2009). This type of study design is associated with greater levels of internal validity due to systematic selection of subjects. This design was adopted to help the researcher understand how a change in dynamic capabilities impacts performance of manufacturing firms in Kenya. Cross-sectional research studies provide a clear 'snapshot' of the outcome and the characteristics associated with it, at a specific point in time. They entail collecting data at and concerning one point in time (Creswell, 2003). It assists the researcher to establish whether significant associations among variables exist at one point in time depending on the resources available and the target population (Saunders, Lewis & Thornhill 2007). This design has been chosen because it is

convenient and saves the researcher time and costs associated with longitudinal studies which involve taking multiple measures over an extended period.

3.2 Target Population

The target population for this study consists of 70 Food Manufacturing firms operating in Nairobi county Kenya and listed in the directory of manufacturers published by the Kenya Association of Manufacturers as of June 2018 KAM draws its membership from firms involved in manufacturing or value addition. The unit of observation was key persons responsible for Finance, Human resources, corporate affairs, Marketing, and Operations.

3.3 Sampling Procedure and sample Size

This study adopted the simplified method developed by Krejcie and Morgan (1970) for determination sample size for a finite population. According to Krejcie and Morgan (1970) the formulae of determining a sample size for a finite population is as follows;

$$s = \frac{X^2 NP(1-P)}{d^2 (N-1) + X^2 P(1-P)}$$

Where;

s = sample size needed.

X^2 = confidence level desired (3.841).

N = population size of population.

P = the population proportion

d = the degree of accuracy.

Informed by Krejcie and Morgan (1970) it was determined that a sample of 59 Firms would suffice for a population of 70. The 59 Firms were chosen using a ratio of 84% from each category to represent the entire population. The sample proportion has been computed as follows;

$$\text{Proportion} = \frac{\text{total sample size}}{\text{total population}}$$

$$59/70 = 84\%$$

The number of respondents per category was determined as shown in Table 1 below:

Table 1 Sample Frame

	Large Scale	Medium scale	Total
Number of enterprises	20	50	70
Proportion	84%	84%	84%
Sample size	17	42	59
Key departments per enterprise	5	5	5
Number of respondents in sample	84	210	294

Source: Author (2019)

This sample size of 295 was considered adequate based on (Cooper & Schindler, 2008) proposition that a sample of at least 30 must exist for generalization to take place.

3.4 Data Collection

Primary data was collected on indicators of dynamic capabilities, firm competence, and performance using semi-structured questionnaire. The instrument was adopted from strategic management studies that have studied similar variables with modifications aimed at addressing the specific objectives. Closed-ended questions were constructed on a 5-point Likert Scale to provide structured responses to facilitate quantitative analysis, testing of hypotheses and drawing of conclusion. However, open-ended questions were used to enable respondents provide additional information that would not be captured in the closed-ended questions. This method was preferred because of the

need to ensure reliability of responses from the respondents. Secondary data was obtained through document review of published sources including government publications KAM periodicals and Monthly Economic Review published by the Kenya National Bureau of Statistics.

The semi structured questionnaires were administered to senior managers responsible for Finance, Marketing, Human Resources and Corporate Affairs in each of the firms. These functional heads were presumed to be knowledgeable in the areas under study. To enhance the support from the organizations, the researcher presented a letter to each organization assuring them of confidentiality. The questionnaire was subjected to a pilot test on managers in five firms to refine the research questions and ensure reliability. The questionnaire was then adjusted based on feedback from the pilot test.

3.6 Validity of Research instrument

Validity refers to how accurately the data collected captures what it is purported to measure (Sekaran, 2011). In this study, Content validity was ensured by subjecting it to double check. To ensure that the questionnaire covers all the areas of the study which include dynamic capabilities, Firm Competence and performance. Content validity of the questionnaire items for the four research variables was verified through literature review and expert suggestions to confirm if theoretical dimensions emerge as conceptualized as recommended by (Mugenda & Mugenda 2003). The study was also informed by instruments developed by other related studies. Face validity of a research is a post hoc assessment of whether on the face of it, the instrument measures a certain construct (Field, 2013). To check for face validity, expert opinion was sought from supervisors and other faculty members (Creswell, 2003). The feedback from expert advice was used to review the questionnaire to ensure that it had face validity prior to conducting the study.

3.7 Reliability of Research Instrument

A pilot study was conducted to establish the extent to which the questionnaire would produce similar and consistent results under similar conditions. The pilot study was conducted among non-food manufacturing firms in Athi River sub county, Kenya to ensure that respondents would not participate in the main study. The internal consistency of the research instruments was measured using Cronbach's Alpha. According to Cooper and Schindler (2003), while a minimum threshold of 0.70 is recommended for exploratory work, a Cronbach's Alpha value above 0.50 is regarded as an indicator of reliability. In this study, the threshold for Cronbach's Alpha of the research instruments was set at $\alpha=0.6$ where variables with α greater than 0.6 were considered to have internal consistency or reliable.

The results of the reliability analysis showed that the questionnaire had an overall Cronbach's Alpha Coefficient of 0.857. The results shows that the questionnaire had an overall Cronbach's Alpha of 0.826 which was found to be suitable for this study. Based on the recommendations of (Field, 2009), and the threshold set for the study, the research questionnaire was found to be reliable.

4. Empirical Findings and Discussion

Descriptive statistics were computed to describe the characteristics of the variables in the study while multiple regression analysis was used to establish the nature and magnitude of the relationships between the independent and dependent variables. Measures of central tendency and dispersion were used to describe the study variables.

4.1 Analysis of Response Rate

An analysis of the responded rate for this study is shown in Table 2

Table 2 Analysis of Response Rate

Response	Frequency	Percent (%)
Returned Questionnaires	190	64.4
Unreturned Questionnaires	105	35.6

Total	295	100
--------------	------------	------------

Source: Survey Data (2019)

A total of 295 questionnaires were distributed to selected food manufacturing firms in Kenya. 190 were filled and returned representing a response rate of 64.4%. According to Babbie (2004); Mugenda and Mugenda (2003) a threshold of 50% is adequate for a study of this nature. According to Wimmer and Dominick (2006), a response rate of 21% - 70% is acceptable for self-administered questionnaires. The overall response rate of 64% was found to be good for the analysis and reporting as it met the criteria by Wimmer and Dominick (2006). Unreturned questionnaires were attributed to factors such as the busy schedules of the respondents since the majority most of the targeted respondents were senior managers in their respective firms. The Demographic characteristics of the respondents are shown in Table 2 below

Table 3 Demographic Characteristics of Respondents

Gender	Frequency	Percent
Male	121	63.7
Female	69	36.3
Total	190	100
Years of service in organization		
1-3 years	26	13.7
4-5 years	56	29.5
more than 5 years	108	56.8
Total	190	100
Core Business		
Beverage Manufacturing	44	23.2
Flour Milling	37	19.5
Sugar Confectionery	24	12.6
Meat & Fish Processing	23	12.1
Dairy Processing	23	12.1
Edible Oil Refining	16	8.4
Bread and Pastry	11	5.8
Spice and Condiments	8	4.2
Honey Processing	4	2.1
Total	190	100
Age of firm	Frequency	Percent
Below 5	5	2.6
6-10 years	64	33.7
Over 10 years	121	63.7
Total	190	100

Source: Research Data (2019)

3.10 Descriptive Statistics

The respondents were asked to respond to statements on each of the variables on a scale of 1-5 Measures of central tendency specifically the mean and standard deviation were used in the study to summarize the characteristics of the variables under study. A summary descriptive statistics of the study variables is shown in Table 2 below.

Table 3: Summary descriptive Statistics of Study Variables

Variable	Listwise N	Aggregate Score	Std. Dev.
Dynamic Capabilities	190	3.96	1.250
Firm Competence	190	3.72	1.168
Firm Performance	190	3.55	1.083

Source: Research Data: 2019

The study sought to find out the extent to which firms had built adaptive capabilities over time Respondents were asked to rate the extent to which their firms had shown commitment to developing Dynamic Capabilities by responding to statements touching on adaptive capabilities on a scale of 1- 5 where 1= "not at all, "2" =Slight Extent", 3 = "moderate extent"4= To a high Extent and 5 = "very high extend". The overall aggregate mean score for commitment of resources to build dynamic capabilities stood at M-3.96 with a standard deviation of 1.250 showing that to a high extent, manufacturing firms commit resources to build Dynamic capabilities.

Firm competence was the mediating variable adopted for this study. Firm Competence was operationalized in terms of foundational competence, Technical competence and Functional competence as categorized by (Cockburn, Henderson & Stem 2000). Firm Competence was operationalized in terms of foundational competence, Technical competence and Functional competence as categorized by (Cockburn, Henderson & Stem 2000). Respondents were asked to state their opinion on the status of each competence shown in the questionnaire on a scale of 1-5 where 1 = "not applicable" 2- "Definitely False", 3=False", 4- "Mostly True" and 5 = "definitely true" Respondents were asked to state their opinion on the status of each competence shown in the questionnaire on a scale of 1-5 where 1 = "not applicable" 2- "Definitely False", 3=False", 4- "Mostly True" and 5 = "definitely true". Firm competence had an aggregate score of 3.72 with a standard deviation of 1.168 indicating that most of the firms had not built core competences.

Firm performance was the dependent variable for the study. The study took the perspective of (Epstein & Buhovac, 2008) that performance is the harmonization of economic environmental and social objectives in the delivery of core business activities to create value for its stakeholders. The variable was operationalized in terms of financial performance, customer satisfaction, employee welfare, social excellence, environmental stewardship and corporate governance. The respondents were required to rate their level of agreement or disagreement with statements pertaining to level of their firm performance on a scale of 1 to 5. Where: 1 = Below 0%, 2 - None (0%) 3= Between 1 - 10%, 4 = between 10 - 20%, over 20%. Results showed that the overall aggregate mean score for performance was 3.55 with a standard deviation of 1.083. Showing that overall performance of manufacturing firms grew between 1 % and 10% over the last three years

4.2 Tests of Hypotheses

In line with MacKinnon, (2011), Firm Competence is a mediator if: First, Dynamic Capabilities significantly accounts for change in Performance. Second, Dynamic Capabilities significantly accounts for change in Firm Competence. Third, Firm Competence significantly accounts for change in Performance when controlling for Dynamic Capabilities. Fourth, the effect of Dynamic Capabilities on Performance decreases significantly when Firm Competence is introduced to the module predicting Dynamic Capabilities from Performance. According to MacKinnon 2008, the Assumptions for mediation are that first, all variables are assumed to be measured on a continuous scale. Second, all variables follow a Normal distribution. Third, there is no correlation among errors and fourth, relationships among the variables are linear. To interpret the results, this study used the 3 model criteria suggested by (Weise, Figueredo, Garcia, Baca & Gable 2013 & MacKinnon, 2011) to test whether firm competence mediated the relationship between dynamic capabilities and performance of food manufacturing firms. According to Mackinnon (2011), variable M is a mediator if X significantly accounts for variability in Y, X significantly accounts for variability in M, M significantly accounts for variability in Y when controlling for X, and the effect of X on Y decreases significantly when M is introduced to the module predicting Y from X. Thus, the results of the regression model are interpreted using the coefficient of the predictor variable before and after mediation using the R^2 and the difference between the beta coefficients of the predictor variable. The total effect (path c) is the sum of the mediated effect (path ab or c-c') and the direct effect path c'). Complete mediation is observed when the mediated effect is statistically significant ($p < 0.5$) and the direct effect is not statistically significant ($P > 0.05$) implying that the mediated effect and total effect are equal (path ab = path c). Thus, if the direct effect (path c') is zero when the mediator is included in the model, then the relationship is entirely mediated by the mediating variable. If, the direct effect between the independent variable and the dependent variable is reduced after controlling for the mediator variable, but the direct effect is still significantly different from zero the mediation effect is said to be partial. Thus, in partial mediation, both the mediated effect and the direct effect are

statistically significant indicating that the mediator significantly accounts for part of the relation between the independent and the dependent variables (Path $ab \neq 0$ and path $c' \neq 0$). The study, therefore, tested the mediation effect using the causal steps method developed by (Baron & Kenny, 1986) to investigate whether the relationship between the three variables against these criteria at a significant level of $P=0.05$.

Step One: Dynamic Capabilities Predicting Firm Performance

Test of Hypothesis One: Dynamic Capabilities have no significant effect on Performance of Manufacturing firms in Kenya.

On the first step, firm performance was regressed on dynamic capabilities to test whether dynamic capabilities significantly accounted for the variability in firm performance of food manufacturing firms. The results of the analysis are summarized in Table 4.

Table 4 Total Effect of dynamic capabilities on Performance

Model Summary						
	R	R Square	Adjusted R Square	Std. Error of the Estimate		
1	0.655 ^a	0.429	0.426	0.49226		
ANOVA ^a						
		Sum of Squares	df	Mean Square	F	Sig.
1	Regression	34.167	1	34.167	141.000	0.000 ^b
	Residual	45.556	188	0.242		
	Total	79.724	189			
Coefficients ^a						
		Unstandardized		Standardized		
		B	Std. Error	Beta	t	Sig.
1	(Constant)	1.076	0.211		5.094	0.000
	Dynamic Capabilities	0.693	0.058	0.655	11.874	0.000

a. Dependent Variable: Firm Performance

Source: Research Data (2019)

The results showed adjusted R-square =0.426 which implied that dynamic capabilities accounted for 42.6% of the variation in firm performance of food manufacturing firms in Kenya. The results for ANOVA F-statistics = 141.000, ($P = 0.000$) shows that the model was statistically significant. This means that dynamic capabilities are a significant predictor of performance of food manufacturing firms. The results for regression coefficient show that dynamic capabilities had $\beta = 0.655$ and P -value=0.000 which is significant at $P < 0.05$ and falls within the confidence interval. The relationship between dynamic capabilities and performance can be estimated in the following equation.

$$Y = 1.076 + 0.655 DC + \epsilon \dots\dots\dots(\text{Model 1})$$

The results show that there exists a significant relationship between dynamic capabilities and performance that can be mediated. The decision criteria were to fail to reject H_{01} if $\beta_1 = 0$ and $P > 0.05$. The results of multiple regression in Table 5, show that adaptive capabilities had $\beta_1 = 0.205$, p -value=0.008. Since $\beta_1 \neq 0$ and p were less than the significant level of 0.05, the study rejected H_{01} implying that dynamic capabilities have a positive and significant effect on the performance of food manufacturing firms in Kenya.

Step Two: Dynamic Capabilities Predicting Firm Competence

Test of Hypothesis Two : H_{02} : Dynamic Capabilities have no significant effect on Firm Competence of Manufacturing firms in Kenya

The third model was fitted to test whether there is a significant interaction between the predictor (dynamic capabilities) and the mediator variable (firm competence). The results of the analysis are summarized in Table 5.

Table 5 Relationship between Dynamic Capabilities and Firm Competence

Model Summary						
Model	R	R Square	Adjusted R Square	Std. Error of the Estimate		
1	0.646 ^a	0.417	0.414	0.84740		
ANOVA ^a						
Model		Sum of Squares	df	Mean Square	F	Sig.
1	Regression	95.730	1	95.730	133.312	0.000 ^b
	Residual	133.564	186	0.718		
	Total	229.294	187			
Coefficients ^a						
Model		Unstandardized		Standardized		
		B	Std. Error	Beta	t	Sig.
1	(Constant)	-0.333	0.356		-0.934	0.351
	Dynamic Capabilities	1.141	0.099	0.646	11.546	0.000

a. Dependent Variable: Firm Competence

Source: Research Data (2019)

The results show that dynamic capabilities accounted for 41.4% (adj.R. Square =0.412) of the variation in firm competence. The study conducted an analysis of variance to determine the significance of the model. The results for ANOVA showed a (F-statistics = 131.312 (p=0.000)). This confirmed that dynamic capabilities are a significant predictor of firm competence. The results for regression coefficient show that dynamic capabilities composite had β - 0.646, p-value = 0.000, meaning that there is a significant interaction between dynamic capabilities and firm competence. *The Study, therefore, rejected the null Hypothesis that Dynamic Capabilities have no effect on Firm Competence.*

FC= -0.333+ 0.646 DC + ϵ (Model 2)

Step Three: Dynamic Capabilities Predicting Firm Performance in the Presence of Firm Competence

Test of Hypothesis Tree H₀₃: Firm Competence has no mediating effect on the effect of Dynamic Capabilities on Performance of Manufacturing firms in Kenya

In the third step the model was fitted to test whether firm performance of food manufacturing firms decreases significantly when firm competence is introduced to the model predicting performance from dynamic capabilities. The results of the analysis are captured in Table 6.

Table 6. Dynamic Capabilities predicting Performance in the presence of Firm Competence

Model Summary						
Model	R	R Square	Adjusted R Square	Std. Error of the Estimate		
1	0.666 ^a	0.443	0.437	0.78070		
ANOVA ^a						
Model		Sum of Squares	df	Mean Square	F	Sig.
1	Regression	89.721	2	44.861	73.604	0.000 ^b
	Residual	112.755	185	0.609		
	Total	202.476	187			
Coefficients ^a						
Model		Unstandardized		Standardized		
		B	Std. Error	Beta	t	Sig.
1	(Constant)	-0.209	0.329		-0.635	0.526
	Dynamic Capabilities	0.868	0.119	0.523	7.276	0.000
	Firm Competence	0.183	0.068	0.195	2.709	0.007

a. Dependent Variable: Firm_Performance

b. Predictors: (Constant), Dynamic Capabilities, Firm Competence

Source: Research Data (2019)

The results of goodness of fit show an adjusted R Square = 0.437. This meant that dynamic capabilities and firm competence accounted for 43.7% of the variation in firm performance of food manufacturing firms. The study conducted an analysis of variance to determine the significance of the model. The results for ANOVA showed (F-statistics = 73.604 (p = 0.000). This confirmed that the model significantly predicted firm performance of manufacturing firms in Kenya. The results for regression coefficient show that dynamic capabilities ($\beta = 0.523$, P-value = 0.000) and firm competence ($\beta = 0.195$ with a p-value = 0.007) showing that dynamic capabilities significantly predicted firm performance even after introduction of Firm Competence. The results are estimated in the equation below

$$Y = -0.209 + 0.523 DC + 0.195 FC + \epsilon \dots\dots\dots \text{(Model 3)}$$

The results show that the effect of Dynamic capabilities on performance in step 1 ($\beta = 0.642$) was higher than $\beta_2 = 0.523$ in step 3. Furthermore, adjusted R-squared increased when competence was introduced as a mediator. The analyses in steps 1-3 thus identified firm competence as a potential mediator of the relationship between dynamic capabilities and performance of food manufacturing firms. Table 5 shows a summary of the tests for mediation.

Table 7 Summary of Mediation effect Test results

Parameter	Model			Change	conclusion
	1	2	3		
β_0	1.076	-0.333	-0.209	1.285	Reject H_{03} There is
β_{DC}	0.655	0.646	0.523	0.132	evidence of Partial
β_{FC}			0.195	-0.195	mediation
Adj. R ²	0.426	0.414	0.437	-0.011	
F	141.00	133.312	73.604	67.396	
P	0	0.000	0.000		
Path a = 0.646, b = 0.195, c = 0.655, c'=0.523					

Source: Research Data (2019)

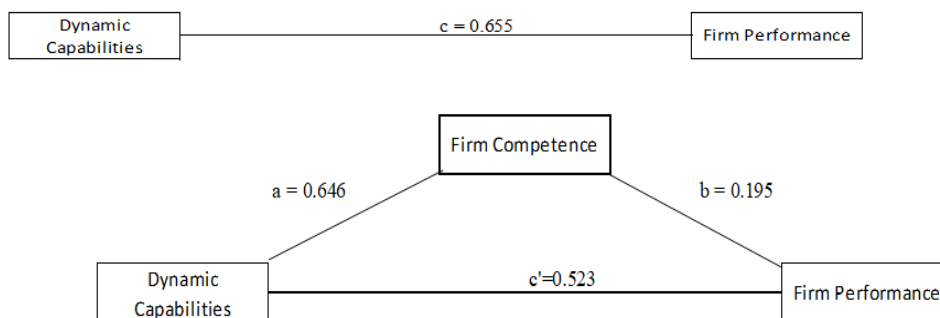

Figure 2 Path Diagram for Dynamic Capabilities, Firm Competence and Firm Performance

Source: Research Data (2019)

When firm competence is introduced in the model predicting firm performance from dynamic capabilities, β is reduced to 0.523 but remains significant at $P = 0.000$. Furthermore, in model 1, dynamic capabilities account for 42.9% of the variation in firm performance but when firm competence is introduced in the model, both variables account for 43.7%. The study also observed that path $ab \neq 0$ and path $c' \neq 0$. Based on the criteria set, the study concluded that Firm competence partially mediates the relationship between, dynamic capabilities and performance of food manufacturing firms.

To determine the indirect effect of dynamic capabilities on performance after introduction of firm Competence, the study used the difference in coefficients method based on information from regression equations in model 1, model 2, and model 3 as recommended by (Mackinnon, Lockwood, & Williams, 2004; Baron & Kenny 1986). Table 8 shows the total, direct and indirect effect of dynamic capabilities on performance of food manufacturing firms in Kenya.

Table 8 Total, direct, and indirect effects of dynamic capabilities on performance

		SE	Sig
Total Effect	0.655	0.49226	0.000
Direct Effect	0.523	0.78070	0.000
Indirect Effect	0.132		

Source: Research Data (2019)

Using difference in Coefficients method, the study determined that firm competence accounts for 13.2% of the effect of dynamic capabilities on performance. *The Study therefore failed to accept the Null hypothesis that Firm competence does not mediate the relationship between dynamic capabilities and performance of manufacturing firms.*

Test of Hypothesis Four: H₀₄: Firm Competence has no significant effect on Dynamic Capabilities of Manufacturing firms in Kenya. The study investigated the mediating effect of dynamic capabilities on the effect of firm competence on firm performance. On the first step, firm competence was regressed on performance to determine whether there was a relationship that can be mediated. The results are summarized in Table 9 below

Table 9 Relationship between Firm Competence and Firm Performance

Model Summary						
Model	R	R Square	Adjusted R Square	Std. Error of the Estimate		
1	.531 ^a	.282	.278	.54849		
ANOVA ^a						
Model		Sum of Squares	df	Mean Square	F	Sig.
1	Regression	21.960	1	21.960	72.997	.000 ^b
	Residual	55.956	186	.301		
	Total	77.916	187			
Coefficients ^a						
Model	Unstandardized Coefficients			Standardized Coefficients	t	Sig.
	B	Std. Error	Beta			
1	(Constant)	1.285	.267		4.804	.000
	Firm Competence	.609	.071	.531	8.544	.000

a. Dependent Variable: Firm PERFORMANCE b. Predictors: (Constant), Firm Competence

Source: Survey data 2020

Results of regression showed an adjusted R²=.278 which implied that Firm competence accounts for 27.8% of the variation in performance. The results for ANOVA F-statistics = 72.997, (P = 0.000) which shows that the model was statistically significant. This means that firm competence is a significant predictor of the performance of food manufacturing firms. The results for the regression coefficient show that firm competence had $\beta = 0.710$ and P-value=0.000 which is significant at P < 0.05.

Performance = 1.285+ 0.609 Firm Competence + ϵ (Model 5)

In the next step, firm competence was regressed on dynamic capabilities to determine the effect of the former on the latter. The results are summarized in Table 10 below....

Table 10: Effect of Firm Competence on Dynamic Capabilities

Model Summary

Model	R	R Square	Adjusted R Square	Std. Error of the Estimate		
1	.656 ^a	.431	.428	.46301		

ANOVA ^a						
Model		Sum of Squares	df	Mean Square	F	Sig.
1	Regression	30.360	1	30.360	141.618	.000 ^b
	Residual	40.089	187	.214		
	Total	70.448	188			

Coefficients ^a						
Model		Unstandardized Coefficients		Standardized Coefficients	t	Sig.
		B	Std. Error	Beta		
1	(Constant)	.926	.224		4.135	.000
	Firm Competence	.710	.060	.656	11.900	.000

a. Dependent Variable: Dynamic capabilities b. Predictors: (Constant), Firm Competence

Source: survey Data 2020

Results of regression showed an adjusted $R^2=42.8$ which implied that Firm competence accounts for 42.8% of the variation in dynamic capabilities. The results for ANOVA F-statistics = 141.618, ($P = 0.000$) shows that the model was statistically significant. This means that firm competence are a significant predictor of dynamic capabilities of food manufacturing firms. The results for the regression coefficient show that firm competence had $\beta = 0.710$ and $P\text{-value} = 0.000$ which is significant at $P < 0.05$. Since $\beta \neq 0$ and $P < 0.05$, the study failed to accept H_4 that Firm competence does not affect a firm's dynamic capabilities. The relationship between firm competence and dynamic capabilities can be estimated in the following equation.

$$D_{\text{ynamic Capabilities}} = 0.926 + 0.710F_{\text{irm Competence}} + \epsilon \dots \dots \dots (\text{Model 6})$$

Test of Hypothesis Five: H_{05} : Dynamic Capabilities have no mediating effect on the effect of Firm Competence on Performance of Manufacturing firms in Kenya

The next step involved regressing firm competence on performance in the presence of dynamic capabilities. The results are summarized in Table 11 below.

Table 11: Firm Competence Predicting Performance in the Presence of Dynamic Capabilities

Model Summary						
Model	R	R Square	Adjusted R Square	Std. Error of the Estimate		
1	.673 ^a	.453	.447	.48002		

ANOVA ^a						
Model		Sum of Squares	df	Mean Square	F	Sig.
1	Regression	35.290	2	17.645	76.578	.000 ^b
	Residual	42.627	185	.230		
	Total	77.916	187			

Coefficients ^a						
Model		Unstandardized Coefficients		Standardized Coefficients	t	Sig.
		B	Std. Error	Beta		
1	(Constant)	.751	.244		3.071	.002
	Firm Competence	.200	.082	.174	2.431	.016
	Dynamic Capabilities	.577	.076	.546	7.606	.000

a. Dependent Variable: Firm PERFORMANCE, b. Predictors: (Constant), Dynamic Capabilities., Firm Competence

Source: Survey Data: 2020

Results of regression showed an adjusted $R^2=0.447$ which implied that Firm competence and dynamic Capabilities account for 44.7% of the variation in firm performance. The results for ANOVA F-statistics = 76.578, ($P = 0.000$) show that the model was statistically significant. This means that firm competence is a significant predictor of the dynamic capabilities of food manufacturing firms. The results for regression coefficient show that firm competence had $\beta = 0.200$ ($P\text{-value}=0.016$) which is significant at $P < 0.05$ and Dynamic capabilities had $\beta = 0.577$ ($P=0.000$) which is significant at $P < 0.05$. The relationship between firm competence, dynamic capabilities and performance can be estimated in the following equation.

$$F_{\text{firm Performance}} = 0.751 + 0.2F_{\text{firm Competence}} + 0.577 D_{\text{ynamic Capabilities}} + \epsilon \dots \dots \dots (\text{Model 6})$$

When dynamic capabilities are introduced in the model predicting firm performance from firm competence, β is reduced to 0.200 but remains significant at $P=0.016$. Furthermore, in model 4, Firm competence accounts for 27.8% of the variation in firm performance but when dynamic capabilities are introduced in the model, both variables account for 44.7%. The study concluded that dynamic capabilities partially mediate the relationship between, Firm Competence and performance of food manufacturing firms. The study, therefore, rejected H_{05} that Dynamic capabilities do not mediate the relationship between Firm Competence and Firm performance. These findings are in line with the findings of (Galavan, 2015)) who suggested that dynamic capabilities are a learning experience whereby firms use capabilities to combine resources to create competences and using feedback from implementation of core competencies to create a higher level of capabilities which in turn creates higher levels of competences.

Findings from descriptive statistics showed that to a great extent, food manufacturing firms had built these competencies and this resulted in an increase in performance by 10%. Foundational competencies such as oral and written communication skills, creative problem solving, teamwork skills, customer focus, dependability, and professionalism to a great extent determine the level of firm performance. These competencies not only increase productivity in food processing firms, but they also enhance firm reputation which in turn enables the firms to command premium prices for their products, pay lower prices for inputs and entice top recruits which in turn helps in stabilizing performance. Functional competencies influence performance by linking firms to their markets, allowing them to do things with a high degree of reliability and flexibility.

In line with the competence-based theory, and Teece (2004), firm competencies that do not create non-imitable products are not core, do not give the firm sustainable performance and competitive advantage. Unique products can only be made when the firm possesses highly specialized skills and equipment. They enable firms to develop a unique position in relation to Competitors and to consistently outperform them (Azak, 2004). By building unique competencies, food manufacturing firms insulate themselves from the competition and can remain operational. By focusing on their core competencies, food manufacturing firms get competitive advantage by doing the things which they excel at.

The biographical data showed that each food processing firms specialized in one core subsector and built competences in that one area only. For instance, flour milling, dairy processing edible oil manufacturing firms were not involved in any other food processing activity. Furthermore, the firms had taken measures to protect their specialized skills and competences from being poached by competitors, the study sought to establish how manufacturing firms in Kenya ensured that competences imbibed in their skilled staff were not poached by competitors.

The findings in this study support the findings of Hodgkinson & Sparrow, (2006); Dubey & Ali (2011), Agha, Alrubaiee & Jamhour, (2012); Özbağ, (2013); Jabbouri & Jahaz, (2014), Bahri & Yahya, (2015) that firm competence has a significant effect on performance. The findings of the study disagreed with those of (Nguyen, 2008) who showed that competence does not have a significant effect on firm performance. The findings help in filling the knowledge gap left by other studies by providing evidence that dynamic capabilities mediate the relationship between firm competence and firm performance.

5. Summary of Findings

The summary of findings is shown in Table 12 below

Table 12 Summary of Findings

Hypothesis	Decision criteria	Finding	Conclusion
H₀₁ : Dynamic Capabilities have no significant effect on Performance of Manufacturing firms in Kenya.	Reject H ₀₁ if P < 0.05	$\beta = 0.655$, P=0.000	Reject H ₀₁ Dynamic Capabilities have a significant effect on Performance of Manufacturing firms in Kenya
H₀₂ : Dynamic Capabilities have no significant effect on Firm Competence of Manufacturing firms in Kenya	Reject H ₀₁ if P < 0.05	$\beta = 0.646$, p-value = 0.000	Reject H ₀₂ Dynamic capabilities are a significant predictor of firm competence. of Manufacturing firms in Kenya
H₀₃ : Firm Competence has no mediating effect on the effect of Dynamic Capabilities on Performance of Manufacturing firms in Kenya	Reject H ₀₃ if β in step1 > β_2 in step 3.	In Step 1 $\beta = 0.655$, Step 3 $\beta = 0.523$, P = 0.000)	Reject H ₀₃ Firm Competence partially mediate the effect of Dynamic Capabilities on Performance of Manufacturing firms in Kenya
H₀₄ : Firm Competence has no significant effect on Dynamic Capabilities of Manufacturing firms in Kenya.	Reject H ₀₄ if P < 0.05	$\beta = 0.710$ and P-value=0.000 which is significant at P < 0.05.	Reject H ₀₄ . Firm Competence has a significant effect on Dynamic Capabilities of Manufacturing firms in Kenya.
H₀₅ : Dynamic Capabilities have no mediating effect on the effect of Firm Competence on Performance of Manufacturing firms in Kenya	Reject H ₀₃ if β in step1 > β_2 in step 3.	In step1 $\beta = 0.710$ 1 in step3 0.200 but remains significant at P=0.016	Reject H ₀₅ . Firm Competence has a significant effect on Dynamic Capabilities of Manufacturing firms in Kenya

Source: Author (2020)

7. Conclusion

Based on the summary findings several conclusions can be made. First, the findings of this study show that dynamic capabilities have a direct and positive effect on organizational performance. Therefore, increasing dynamic capabilities can increase overall firm performance of food manufacturing firms. Second the study concludes that firm competences have a positive effect on the performance of food manufacturing firms. Third, the study further concludes that firm competences partially mediate the relationship between dynamic capabilities and performance. Fourth, Dynamic Capabilities mediate the effect of Firm Competence on Firm Performance. Fifth, Firm Competence Mediates the effect of dynamic capabilities on performance. The dual effect of firm competence and dynamic capabilities supports the theory that dynamic capabilities help firms to configure resources to create competences which results in superior performance. VRIO competences enable firms to build higher level capabilities which results in higher levels of competence which in turn enhances performance and the circle goes on and on. This is how firms achieve sustainable performance. Therefore, manufacturing firms can increase their performance by building and applying both dynamic capabilities and firm competences. Sixth Dynamic capabilities and firm competence act as both a mediator and predictor variables. The study concludes that firms use dynamic capabilities to configure resources to build unique competences. These competences enable them not only to achieve superior performance but also to build higher order capabilities which they use to reconfigure resources to build core competences to achieve superior performance and the circle repeats itself. The continuous sharpening of competences and dynamic capabilities is what creates sustainable performance.

8. Policy Implications and Recommendations

From the findings of this study, several policy implications can be drawn for effective, application of dynamic capabilities in food manufacturing firms in Kenya. First, dynamic capabilities were found to have a significant effect on the performance of the respondents' firms. Consequently, management of manufacturing firms should deliberately build dynamic capabilities to enable them to scan the environment for opportunities, threats and technologies that will inform their strategies on how to respond to changes in the market. Moreover, manufacturing firms should build resilience to enable them to survive and adversities and unforeseen changes in the market. Further, the study recommends that management of manufacturing firms create environment for employees to offer solution besides traditional strategies to effectively respond to market disruptions.

Most of the firms scored low on some aspects of foundational competences especially on existence of anti-corruption policies. Noting the importance of having sound values for all employees at the workplace irrespective of their function in the organization, the study recommends that manufacturing firms review their anti-discrimination and anti-corruption policies to enhance their foundational competences. Furthermore, most of the respondents indicated that both their superior brands and specialized skills could easily be replicated or poached by competitors. In this regard, the study recommends that manufacturing firms develop measures to protect their competitiveness by developing functional competences that cannot be easily replicated or poached by their peers.

According to Schoemaker, Heaton and David Teece (2018), the world in which today's businesses operate has become not only riskier but also more volatile, uncertain, complex, and ambiguous (VUCA). Consequently, organizations are counting more on their core competences and dynamic capabilities to secure their financial success and their market positions (Hamel & Prahalad, 1994, Teece, 2007). Firm strategy in food manufacturing firms in Kenya, therefore, must shift focus from competing for product or service leadership to competing in firm competence leadership.

9. Limitations

The study was not without limitations. First there study was done in Nairobi County, the capital of the Republic of Kenya, a location that had different infrastructure from the rest of the country. The results may therefore not be generalizable to other locations with different circumstances. Secondly, the study was done in only the food subsector and therefore not all results may be easily generalizable to other manufacturing subsectors.

10. Contribution of the study to Knowledge

This study contributes to the general body of knowledge in several ways. First, it contributes the ongoing discourse on why some firms perform better than others by empirically testing the effect of dynamic capabilities on performance for food manufacturing firms in Kenya. Second, it helps in settling the dispute on the role of dynamic capabilities on firm performance. Previous scholars have argued that dynamic capabilities are mediators, predictors, and moderators of firm performance. Third, this study establishes empirically that dynamic capabilities positively and significantly influence the performance of manufacturing firms. Third, this study contributes to the discourse on the relationship between dynamic capabilities and firm competence and their role on firm performance. It establishes that firm competences mediate the effect of dynamic capabilities on firm performance. Fourth, this study lays a foundation for future research on the interaction between dynamic capabilities, firm competence and firm performance.

11. Recommendations for future Studies

This study recommends several areas of further research. First, the study shows that Dynamic Capabilities, explained 43% of the variation in performance food manufacturing firms. The study recommends that further studies should focus in establishing other factors that account of the remaining 65.6% of the variation in performance of the food manufacturing firms in Kenya. Second, further studies should also focus on other sectors

such as the service sector to get more insights on how dynamic capabilities interact with competence to influence performance in the service sector.

References

- Agha, S., Alrubaiee, L. & Jamhour, N. (2012) Effect of Core Competence on Competitive Advantage and Organizational Performance *International Journal of Business and Management* Vol. 7, No. 1; January 2012 www.ccsenet.org/ijbm
- Alvarez, S. & Barney, J. (2000). Entrepreneurial Capabilities: A Resource-Based View, *Entrepreneurship as Strategy: Competing on Entrepreneurial Edge* Thousand Oaks, London, and New Delhi: Sage Publications.
- Alvarez, V. S. & Merino, T. G. (2003). The history of organizational renewal: evolutionary models of Spanish savings and loans institutions. *Organization Studies*, (9), 1437-1461.
- Akintoye, I.R. (2008) "Sensitivity of Performance to Capital Structure: A Consideration for Selected Food and Beverages Companies in Nigeria". *Journal of Social Sciences*, Hellenic Open University, Greece. Vol. 7 Issue 1. Pp. 29-35.
- Ambrosini, V., Bowman, C. & Collier, N. (2009). What are Dynamic Capabilities and are they a useful construct in strategic management? *International Journal of Management Reviews* doi: 10.1111/j.1468-2370.2008.00251.
- Arend, R.J. (2014). Social and environmental Performance at SMEs: considering motivations, capabilities, and instrumentalism. *Journal of Business Ethics* 125: 541-561.
- Arend, R. J., & Bromiley P. (2009). Assessing the Dynamic Capabilities view: spare change, everyone? *Strategic organization* Vol 7(1):75–90
- Barney, J. B., Wright, M. & Ketchen, J. D. (2001). The Resource-Based View of the Firm. *Journal of Management*. 27(625) <https://www.researchgate.net/publication/228558289>
- Baron, R. M., & Kenny, D. A. (1986). the moderator-mediator variable distinction in social psychological research: Conceptual, strategic, and statistical considerations. *Journal of Personality and Social Psychology*, 51, 1173-1182.
- Chang, C. (2012). Exploring IT entrepreneurs' Dynamic Capabilities using Q-technique", *Industrial Management & Data Systems*, Vol. 112 Iss 8 pp. 1201 – 1216: <http://dx.doi.org>
- Chang C & K Kuo C (2013) Exploring Dynamic Capabilities of executives for core strategy *African Journal of Business Management* Vol. 7(40), pp. 4188-4198, 28 October 2013 DOI: 10.5897/AJBM12.1261 ISSN 1993-8233 <http://www.academicjournals.org/AJBM>
- Combs, J. G., Crook, T. R., & Shook, C. L. (2005). The dimension of organizational performance and its implications for strategic management research. In D. J. Ketchen & D. D. Bergh (Eds.), *Research methodology in strategy and management* (pp. 259-286). San Diego: Elsevier
- Cooper, C. R., & Schindler, P. S. (2008). *Business research methods* (10 ed.). Boston: McGraw-Hill.
- Creswell, J. W. & Plano C. (2011). *Designing and conducting mixed method research* (2nd ed.). Thousand Oaks, CA: Sage.
- Danneels, E. (2002), The dynamics of product innovation and Firm Competences: *Strategic Management Journal Strat. Mgmt. J.*, 23: 1095–1121 (2002) Published online 19 September 2002 in Wiley InterScience (www.interscience.wiley.com). DOI: 10.1002/smj.275
- Day, G.S. (2012). Managing the market learning process. *Journal of Business & Industrial Marketing*, *International Journal of Business and Management* Vol. 7, No. 1; 17(4), 240–252
- Dubey R. & Ali, S.S. (2011), Study on Effect of Functional Competency on Performance of Indian Manufacturing Sector, *International Journal of Engineering Business Management* First Published January 1, 2011 Research Article <https://doi.org/10.5772/50941>
- Drnevich, P. & Kriauciunas A (2011) Clarifying the conditions and limits of the contributions of ordinary dynamic capabilities to relative firm performance. *Strategic Management Journal*. J 32: 254-279(2011) DOI 10.1002/sml.882
- Easterby-Smith, M., Marjorie A. Lyles & Margaret, A. (2008) Dynamic Capabilities: Current Debates and Future Directions *British Journal of Management*, Vol. 19, 235–249 DOI: 10.1111/j.1467-8551.2008.00609.x
- Fai, F. & Tunzelmann, V (2001) Technological core competencies: reality or myth? School of Management, University of Bath, Claverton Down, Bath BA2 7AY, UK.
- Field, A. P. (2005). *Discovering statistics using SPSS*, 2nd edition. London: Sage
- Gavrea, C., Ilieș, L., & Egerean, R. (2011). Determinants of organizational performance: The case of Romania. In *Management & Marketing Challenges for the Knowledge Society* (pp. 285-300).
- GOK (2018); *Economic survey*, Nairobi, Kenya

- Hayes A.F & Preacher, J. (2010) Quantifying and Testing Indirect Effects in Simple Mediation Models When the Constituent Paths Are Nonlinear Multivariate *Behavioral Research*, 45:627–660, Copyright © Taylor & Francis Group, LLC ISSN: 0027-3171 print/1532-7906 online DOI: 10.1080/00273171.2010.498290
- Hayes, A.F. (2009): Beyond Baron and Kenny: Statistical Mediation Analysis in the New Millennium, *Communication Monographs*, 76:4,408-420: <http://dx.doi.org/10.1080/03637750903310360>
- Helfat, C. E. (1997). Know-How and Asset Complementarity and Dynamic Capability Accumulation: The Case of R&D, *Strategic Management Journal* 18(5): 339–60.
- Helfat, C. E. & Peteraf, M. A. (2003). The Dynamic Resource-Based View: Capability Lifecycles Dynamic Capabilities Deconstructed', *Strategic Management Journal* 24(10): 997–1010.
- Helfat C E & Peteraf, M.A. (2009): Understanding dynamic capabilities: progress along a developmental path. *Strategic Organization* Vol 7(1): 91–102
- Hill, C.W. L. & Jones, G. R. (2010). Strategic management theory an integrated approach (9th Ed). Mason, OH South-Western/Cengage learning <https://trove.nla.gov.au/work/8643727>
- Hubbard, G (2006) Measuring *Organizational Performance: Beyond the Triple Bottom Line*. Business Strategy and the Environment. Published online on 19 December 2006 in Wiley InterScience (www.interscience.wiley.com) DOI: 10.1002/bse.564
- Hung, R.Y., Yang, B., Lien, B.H., McLean, G. N. & Kuo, Y.M. (2010). Dynamic capability: Impact of process alignment and organizational learning culture on Performance. *Journal of World Business* 45(3): 285-294.
- Jabbouri, N. & Zahar, I. (2014). The role of core competencies on organizational Performance: an empirical study in the Iraqi private banking sector, *European Scientific Journal June 2014 /SPECIAL/ edition vol.1 ISSN: 1857 – 7881*
- Groen, Aard J. (2010). The Resource-Based View: A Review and Assessment of Its Critiques. *Journal of Management*. 36. 349-372. 10.1177/0149206309350775.
- Krejcie, R. V. & Daryle W. Morgan, D.W. (1970) Determining sample size for research activities. *Educational and Psychological Measurement* 1970, 30, 607-610. <https://home.kku.ac.th>
- Mackinnon D.P (2011) Integrating mediators and moderators in Research design NHIH *Public Access Res Soc Work Pract.* 2011 November; 21(6): 675–681. doi:10.1177/1049731511414148.
- Maltz, A.C., Shenhar, A.J. and Reilly, R.R. (2003). 'Beyond the balanced scorecard. Refining the search for organizational success measures. *Long Range Planning*, 36: 187204
- Miller, T. L., & Wesley, I. I. (2010). Assessing mission and resources for social change: an organizational identity perspective on social venture capitalists' decision criteria. *Entrepreneurship Theory and Practice* 34(4): 705-733.
- Nguyen, T. M., (2008) Functional competencies and their effects on performance of manufacturing companies in Vietnam. *PHD Thesis presented to the Faculty of Economics and Social Sciences at the University of Fribourg (Switzerland)*.
- Peteraf, M. A., Di Stefano, G., & Verona, G. (2013). The elephant in the room of dynamic capabilities: Bringing two diverging conversations together. *Strategic Management Journal*, Wiley Online Library (wileyonlinelibrary.com).
- Peteraf, M.A. & Barney, J.B. (2003). Unravelling the resource-based tangle. *Managerial and Decision Economics*, Vol. 24, pp. 309-323.
- Pierre J. R., Timothy M. D., George S. Y. & Gerry J. (2009) Measuring organizational performance: Towards Methodological Best Practice, *Journal of Management*, 20(5): 78 - 80.
- Pisano, G. (2016) Towards a Prescriptive Theory of Dynamic Capabilities: Connecting Strategic Choice, Learning, and Competition. *Harvard Business School Working Paper 16-146*.
- Post, J.E., Preston, L.E. & Sachs, S. (2002). Managing the extended enterprise: the new stakeholder view. *California Management Review* 45(1): 6–28.
- Preacher, K. J., & Hayes, A. F. (2004). SPSS and SAS procedures for estimating indirect effects in simple mediation models. *Behavior Research Methods*, 36, 717-731.
- Prahalad, C.K. & Hamel, G. (1990) [the core competence of the corporation](#) , *Harvard Business Review* (v. 68, no. 3) pp. 79–91
- Promar Consulting (2016), promoting the development of food value chains in Africa 2015 – Kenya; *Report prepared for Japanese Ministry of Agriculture, Forestry and Fisheries (MAFF)*http://www.maff.go.jp/j/kokusai/kokkyo/food_value_chain/attach/pdf/haifu_chousa27-31.pdf
- Protogerou, A., Caloghirou, Y. & Lioukas, S. (2011) Dynamic Capabilities and Their Indirect Impact on Firm Performance, DRUID Working Paper no. 08-11 JEL codes: ISBN: 978-87-7873-265-1
- Rehman, K. & Saeed, Z. (2015). Impact of Dynamic Capabilities on Firm Performance: Moderating Role of Organizational Competencies *Journal of Business Management*, Volume: 2, No. 2 | October 2015

- Richard, P.J., Devinney, T.M., Yip G.S. & Johnson, G. (2009) Measuring Organizational Performance: Towards Methodological Best Practice, *Journal of Management* DOI: 10.1177/0149206308330560 2009 35: 718 originally published online 6 February 2009
- Saunders, M. Lewis, P. & Thornhill, A. (2007). Research methods for business, Students edition, Great Britain, Prentice Hall
- Sekaran, U. (2011). Research Methods: A skill building approach. John Wiley and Sons
- Stiles, Wi. (2003). When is a case study scientific research? *Psychotherapy Bulletin*. 38. 6-11.
<https://www.researchgate.net/publication/284486969>
- Teece, D.J. (2018), Business models and Dynamic Capabilities *Long Range Planning Volume 51, Issue 1, February 2018, Pages 40-49*: Institute for Business Innovation, F402 Haas School of Business, #1930, University of California, Berkeley, Berkeley, CA 94720-1930, USA
<https://doi.org/10.1016/j.lrp.2017.06.007>
- Teece, D. J., (2017), Dynamic Capabilities and (Digital) Platform Lifecycles, in Jeffrey Furman, Annabelle Gawer, Brian S. Silverman, Scott Stern (ed.) Entrepreneurship, Innovation, and Platforms (*Advances in Strategic Management, Volume 37*) Emerald Publishing Limited, pp.211 – 225
- Teece, D. J. (2014). A dynamic capabilities-based entrepreneurial theory of the multinational enterprise. *Journal of International Business Studies*, 45(1), 8-37. doi: 10.1057/jibs.2013.54
- Teece, D. J. (2012). Dynamic capabilities: Routines versus entrepreneurial action. *Journal of Management Studies*, 49(8), 1395-1401.
- Teece, D. J. (2007). Explicating Dynamic Capabilities: The Nature and Micro foundations of (Sustainable) Enterprise Performance, *Strategic Management Journal* 28(13): 1319–50.
- Teece, D. J., G. Pisano, & A. Shuen (1997). Dynamic capabilities and strategic management. *Strategic Management Journal*, 18(7), 537–533. [http://dx.doi.org/10.1002/\(SICI\)1097-0266\(199708\)18:7<509::AID-SMJ882>3.0.CO;2-Z](http://dx.doi.org/10.1002/(SICI)1097-0266(199708)18:7<509::AID-SMJ882>3.0.CO;2-Z)
- Wang, C. L. & Ahmed, P. K. (2007). Dynamic capabilities: a review and research agenda. *The International Journal of Management Reviews*, 9(1): 31-51.
- Wang, D., Su, Z., & Yang, D. (2011). Organizational culture and knowledge creation capability. *Journal of Knowledge Management*, 15(3) 363-373.
- Wei L & Lau, C (2010) High performance work systems and performance: The role of adaptive capability. *Human Relations* 63(10) 1487–1511 DOI: 10.1177/0018726709359720 hum.sagepub.com
- Weise, D., Figueredo, A.J., Garcia, R.A., Baca, T.C & Gable, J.C (2013) Revisiting Mediation in the Social and Behavioural Sciences, *Journal of Methods and Measurement in the Social Sciences, Vol.4, No.1, 1-19, 2013*
- Winter, S. G. (2003). Understanding dynamic capabilities. *Strategic Management Journal*, 24(10), 991-995.